

# HDS3200 Terminal Series Owner's Manual

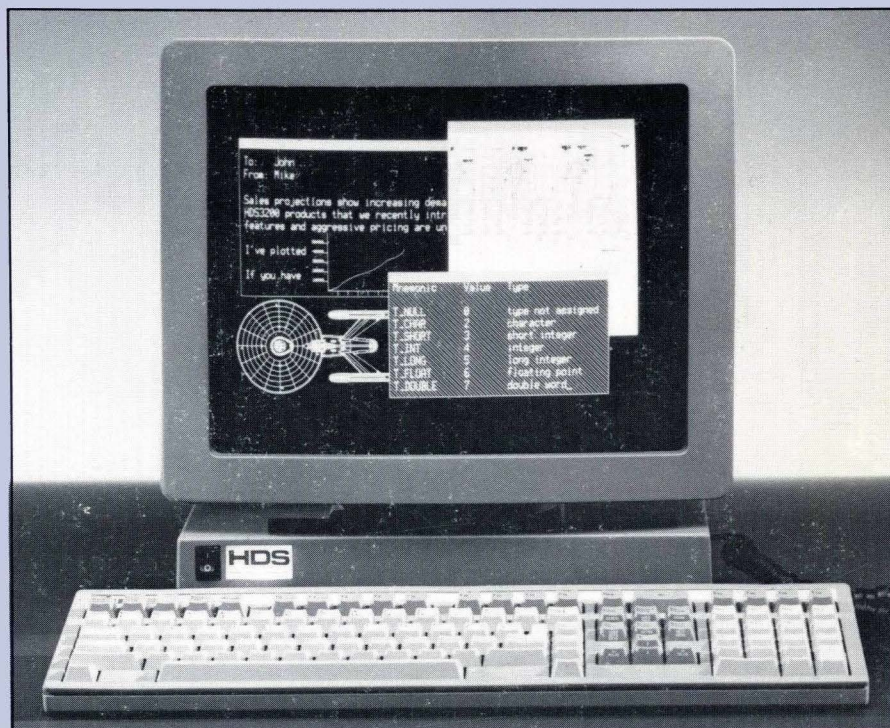

**HDS**  
**human designed systems**

# HDS3200 Terminal Series Owner's Manual

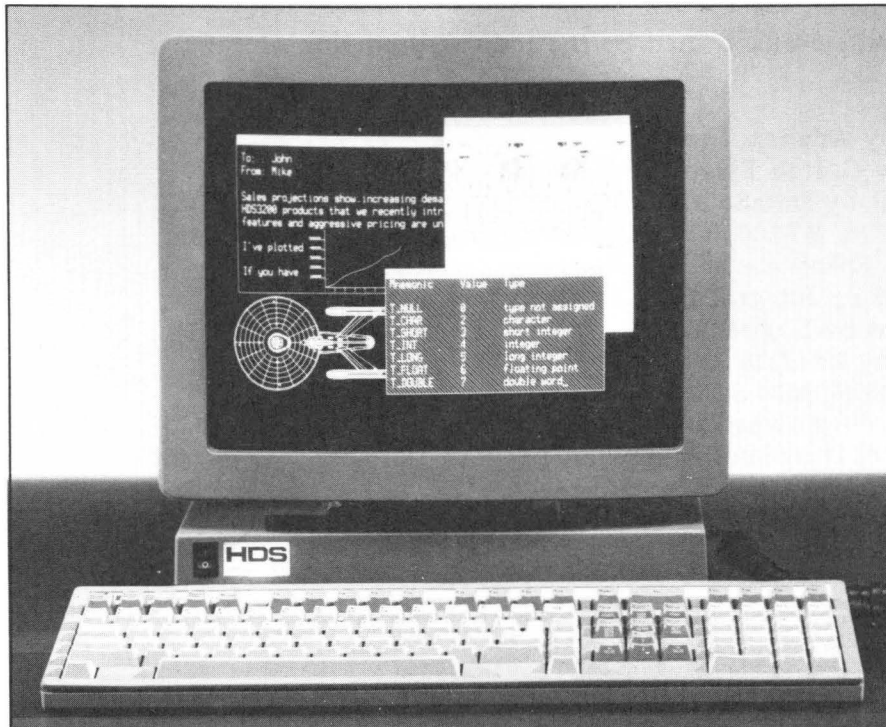

**HDS**  
human designed systems

3440 Market St., Philadelphia, PA 19104  
1-800-HDS-1551, in PA call 1-215-382-5000

## HDS3200 Owner's Manual

© 1987 by Human Designed Systems, Inc.  
3440 Market Street  
Philadelphia, PA 19104  
(215) 382-5000

This manual is copyrighted by Human Designed Systems, Inc. All rights are reserved. This document may not, in whole or in part, be copied, photocopied, reproduced, translated, or reduced to any electronic medium or machine-readable form without prior consent, in writing, from Human Designed Systems, Inc.

HDS, HDS3200 are trademarks of Human Designed Systems, Inc.

The following trademarks, owned by the indicated parties, are used in this manual.

Anadex owned by Anadex, Inc.  
C. Itoh owned by C. Itoh Electronics, Inc.  
DataSouth owned by DataSouth Computer Corp.  
DEC, LA75, VT100, VT200, VAX owned by Digital Equipment Corp.  
Epson owned by Epson America, Inc.  
IDS Prism owned by Integral Data Systems, Inc.  
Logimouse owned by Logitech, Inc.  
Okidata owned by Okidata Corp.  
Summagraphics, MM, MM Series owned by Summagraphics Corp.  
Tektronix, 4010, 4014 owned by Tektronix Inc.  
ThinkJet, LaserJet II owned by Hewlett-Packard Corp.

Printed in the U. S. A.

## HDS3200 Owner's Manual

Dear HDS3200 Terminal User:

Thank you for ordering an HDS3200 Image Leader terminal. We think you'll enjoy its ease of use, its readable screen, and its powerful features. We would like to hear your comments about our products and your terminal needs.

At Human Designed Systems we take pride in the level of service that we offer to our customers. If you have any questions as you set up and use your new HDS3200 terminal, please feel free to call your local HDS office, or our Philadelphia headquarters at (215) 382-5000.

Our **Technical Support Group** is equipped to answer your questions about communications, connecting with various computers, software compatibility, and other help you might need with software programs. The **Service Department** deals with hardware problems and is the source of the RA (Return Authorization) numbers that are needed for shipment of repair items to our service centers.

Once again, thank you for your business. We hope that you'll be happy with your new HDS3200 terminal. Please feel free to call if we can be of any assistance.

Very truly yours,

Human Designed Systems, Inc.

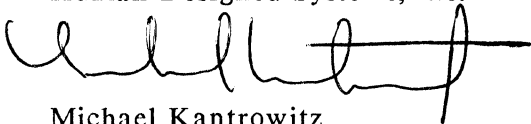
A handwritten signature in black ink, appearing to read "Michael Kantrowitz", with a long horizontal stroke extending to the right.

Michael Kantrowitz  
Vice President of Marketing

MK/vb



## WARRANTY

Human Designed Systems, Inc. (HDS) warrants that each terminal will be free from defective materials and workmanship for twelve (12) months from the date of shipment to the original customer. In addition, HDS warrants that the terminal software will operate according to specification for twelve (12) months from date of shipment to the original customer.

HDS agrees to correct any of the above defects (parts and labor only) when the terminal is returned to the factory freight prepaid by the customer. Return authorization must be obtained from HDS before returning the terminal to the factory. The repaired terminal will be returned to the customer freight prepaid.

Under this warranty HDS may at its option repair or replace the defective terminal or terminal components. Normally, HDS will not ship replacement equipment until the defective terminal or terminal component is received (freight prepaid by the customer) at the HDS factory or service depot -- HDS at its option may ship replacement equipment prior to receipt of the defective equipment. In this case the customer will receive an invoice for the full price of the equipment upon shipment of the replacement and a cancellation of that invoice upon receipt of the defective terminal or terminal component at HDS' factory or service depot. The model number and serial number of the terminal must be furnished by the customer at the time of request for warranty service.

This warranty shall be invalid if, in HDS' sole judgment, the terminal or terminal component has been subjected to misuse, abuse, neglect, accident, improper installation or application, alteration or neglect in use, storage, transportation or handling, or if the serial number has been removed, defaced, or altered.

## FEDERAL COMMUNICATIONS COMMISSION

### Radio Frequency Interference Statement

The Federal Communications Commission (in Subpart J, of Part 15, Docket 20780) has specified that the following notice be brought to the attention of the users of this product.

### WARNING

This equipment generates, uses, and can radiate radio frequency energy and if not installed and used in accordance with the instructions manual, may cause interference to radio communications. It has been tested and found to comply with the limits for a Class A computing device pursuant to Subpart J of Part 15 of FCC rules, which are designed to provide reasonable protection against such interference when operated in a commercial environment. Operation of this equipment in a residential area is likely to cause interference in which case the user at his own expense will be required to take whatever measures may be required to correct the interference.

Shielded cables must be used with this unit to insure compliance with the Class A limits.

## How To Use This Manual

This *HDS3200 Owner's Manual* is intended for everyone who uses the HDS3200 terminal. It contains essential information, such as communications settings and Setup Menu options that all will use. It also contains supplementary information for special features and advanced terminal applications designed for advanced users. A Quick Reference section of terminal commands is included at the end of this manual for all users.

Another manual, the optional *HDS3200 Programmer's Reference Manual*, contains detailed descriptions of all the terminal commands and discussions of the sophisticated features of the HDS3200. This manual will be of interest to more advanced users. The *HDS3200 Service Manual* is for terminal repair technicians.

The *HDS3200 Owner's Manual* is made up of independent sections, which the you should read as your needs require. If you don't understand a concept or some feature of the terminal, just go on to another section; you don't have to read everything. This manual is organized so you may choose, buffet-style, the things necessary for working with the terminal. The summary sections at the beginning of each chapter describe the concepts and information contained in the chapter. The material is arranged in increasing complexity within each section.

Working with a computer or terminal successfully often requires little direct knowledge of the machinery or software in an operational or a theoretical sense. These suggestions may help you find a simple way to use this material for your own purposes. Scan the manual for the types and locations of things it covers first, then study and use the sections as your need for them arises. The following outlines suggest reading plans for different types of terminal users. The outlines give chapter numbers and title abbreviations.

<b>VT220 Applications User</b>	<b>Graphics Terminal User</b>	<b>Experienced Terminal User</b>
2 - Setup Mode	2 - Setup Mode	2 - Setup Mode
3 - Communications	3 - Communications	3 - Communications
4 - User Defined Keys	4 - User Defined Keys	others as needed
5 - Graphics Setup	5 - Graphics Setup	
6 - Calculator	7 - Zoom/Pan Operation	
	8 - Advanced Graphics	

The Quick Reference section contains complete listings of all terminal commands, operating modes, and graphics commands. It also has lists of all the User Defined Key assignments, including factory definitions for various keypads and operating modes.

The Table Of Contents which follows is a good place to begin. It contains a summary of the contents for each chapter and lists the sections contained in it.

The Glossary and Index help you understand difficult terms or locate reference sections for key words.

TABLE OF CONTENTS

ii	Copyright page
iii	Welcome Letter
iv	Warranty
iv	FCC Statement
v	How To Use This Manual
vi	Table of Contents

**Chapter 1** *Getting Acquainted With The HDS3200 Terminal*

1-1	<b>Summary</b> <i>This chapter describes the terminal in general terms, including the optional features that are available. There are instructions for unpacking the terminal and setting it up, including drawings of various essential parts, such as the communications ports, the adjustment knobs, etc. A simple power-on test procedure is given. There is a complete description of the terminal keyboard, including each keyboard group and its function. Each key and its operation is described.</i>
1-1	The HDS3200 Terminal
1-2	Terminal Models In The HDS3200 Series
1-3	Unpacking The Terminal
1-5	If The Terminal Doesn't Work....
1-5	The Terminal Keyboard
1-6	Main Keyboard Group And The Numeric Keypad
1-7	Local Operation Keypad
1-9	Setup Mode Keys
1-9	User Defined Keys
1-10	Cursor Pad Keys
1-11	Keyboard Controls From Setup Mode

**Chapter 2** *Using The Terminal In Setup Mode*

2-1	<b>Summary</b> <i>This chapter describes Setup Mode and its use in operating the terminal efficiently. Definitions and explanations of the procedures and lists of the options are given, along with examples of typical applications.</i>
2-1	What Is Setup Mode?
2-1	Using Setup Mode
2-3	Using The Mouse In Setup Mode
2-3	Saving Setup Mode Configurations
2-4	General Setup Menu
2-6	User Preference Setup Menu
2-8	Communications Setup Menu
2-9	User Defined Key Setup Menu
2-10	Keyboard Setup Menu
2-12	Graphics Setup Menu
2-13	HDS Extensions Setup Menu
2-15	Terminal Status Lines

**Chapter 3** *Setting Up Communications With The Computer*

- 3-1 **Summary** *This chapter describes the physical connections and the handshaking protocols needed to connect the terminal with other devices. Lists and tables, as well as accompanying definitions, are included for each communication port and protocol option. Instructions for choosing and saving the configuration from Setup Mode are included.*
- 3-1 Some Suggestions On Procedure
- 3-1 Making The Cable Connection
  - 3-2 HDS3200 Back Panel
  - 3-3 Communications Port Pin Assignments
  - 3-3 RS-232 Connector Pin Assignments
- 3-4 Setting The Communications Protocol
- 3-6 Default Communication Settings
- 3-6 Making The Settings In Setup Mode
  - 3-8 Printer Settings
  - 3-9 Printed Data Type Setup Mode Selections
  - 3-10 Port 3 Mouse And Digitizer Tablet Selections
- 3-11 Some Troubleshooting Suggestions
- 3-12 Optional 20 ma Current Loop Interface
- 3-12 Optional RS-423 Interface

**Chapter 4** *User Defined Function Keys*

- 4-1 **Summary** *The HDS3200 terminal has three sets of 21 programmable function keys that, shifted and unshifted, can accept 126 definitions by the user to send any key sequence or command. All these keys receive their definitions from the user by means of Setup Mode, with a simple menu and definition procedure. Three separate sets of key definitions can be entered and techniques for using this feature from Setup Mode are discussed. A chart is included which lists all the User Defined Keys and their factory settings. This chapter also describes programming the keys on the mouse and digitizer tablet.*
- 4-1 Programmable Keys
- 4-2 Defining Keys From Setup Mode
  - 4-2 Programming User Defined Keys
  - 4-3 Special Characters In Key Definitions
  - 4-3 Mouse And Digitizer Key Programming
  - 4-4 Storage Limitations For User Defined Keys
- 4-4 Locking User Defined Key Programming
- 4-4 Reset Definitions To Factory Defaults
- 4-4 Three Function Key Sets
- 4-5 User Defined Keys Keychart
  - 4-5 Unshifted Keys
  - 4-6 Shifted Keys
  - 4-7 Mouse/Digitizer Keys
  - 4-8 Cursor/Numeric Pad

**Chapter 5 Graphics Terminal Operation**

- 5-1 **Summary** *This chapter contains an overview of the graphics capabilities of the HDS3200 Series graphics terminals, Models 10, 20, and 30. Since the utilization of most graphics features of the terminal is done by the user's application programs, the information presented here is for entering and exiting graphics mode, setting up and using the mouse and digitizer tablet, configuring the terminal for printer support, and for graphics data transmission protocols.*
- 5-1 HDS3200 Series Graphics Terminals
- 5-1 HDS3200 Series Graphics Terminal Features
- 5-2 The *Text Graph* Key
- 5-2 The *Next Scrn* Key
- 5-2 Graphics Configuration In Setup Mode
- 5-4 Graphics Alpha Mode Screen Display
- 5-5 Printer Buffer From Graphics Mode
- 5-5 GIN (Graphical Input) Mode Operation
- 5-5 Using The Mouse And Digitizer Tablet
- 5-6 Using The Digitizer Tablet

**Chapter 6 On-Screen Calculator**

- 6-1 **Summary** *This chapter describes the function of the on-screen calculator and the keys it uses on the keyboard.*
- 6-1 Calculator Mode
- 6-1 Calculator Functions

**Chapter 7 HDS Mouse Operation**

- 7-1 **Summary** *This chapter describes the setup of the HDS mouse and summarizes the different settings it uses in the various operating environments of the terminal. The mouse keys and their key definitions are given.*
- 7-1 Setting Up The HDS Mouse
- 7-3 Using The Mouse Buttons
- 7-4 Mouse Operation In Setup Mode
- 7-4 Using The Mouse For Cursor Movement
- 7-5 The Mouse In Zoom/Pan Definition Modes
- 7-5 The Mouse In GIN (Graphical Input Mode)
- 7-5 Mouse Key Programming

**Chapter 8 Graphics Zoom/Pan Operation**

- 8-1 **Summary** *This chapter describes the Zoom and Pan functions and the operation of Zoom and Pan Definition Modes, including the keys and mouse used in these operating modes. The emphasis is on the operation of Zoom/Pan Definition Modes, not the concepts or techniques underlying its function. The chapter describes the operation of zoom controls and the zoom box. The use of pan controls, the pan box, and the behavior of the pan box with a zoomed image is also discussed. The chapter also describes returning the graphics screen to normal with the Times 1 function.*

## HDS3200 Owner's Manual

- 8-1 Zoom And Pan Functions
- 8-1 Zoom And Pan Definition Modes
- 8-2 Using Zoom Definition Mode
- 8-4 The Times 1 Draw Function
- 8-5 Using Pan Definition Mode
- 8-7 The Mouse In Zoom/Pan Definition Modes
- 8-8 Anisotropic Zoom Controls
- 8-8 Keys Active In Zoom/Pan Definition Modes
- 8-10 Using Zoom/Pan Within An Application Program

### Chapter 9 *Advanced Graphics Concepts*

- 9-1 **Summary** *This chapter discusses concepts of terminal operation as they apply to graphics operations. The concepts focus around the storage of a graphics image in memory, its projection onto the screen, and the manipulations available in the process.*
- 9-1 Storage Of A Graphics Image
- 9-1 Data Logging
- 9-2 Display List Memory Size
- 9-3 Graphics Quadrant Mode
- 9-4 The 4096 Grid Of Logical Memory
- 9-5 The Zoom And Pan Functions
- 9-5 Graphics Status Line
- 9-6 Some Additional Graphics Considerations

### Chapter 10 *Multiple Computer Applications*

- 10-1 **Summary** *This chapter describes advanced applications of the HDS3200 terminal including multiple computer networking, windows, and screen line display.*
- 10-1 Multiple Computer Applications
- 10-1 Multiple Computer Connections
- 10-2 Display Memory And Windows
- 10-4 Multiple Computers And Multiple Windows
- 10-5 Simultaneous Display On The Screen
- 10-6 User Defined Keys And Multiple Computer Applications
- 10-7 Programming Three Function Key Sets
- 10-8 Other Considerations

### Chapter 11 *Terminal Maintenance*

- 11-1 **Summary** *This chapter describes some simple procedures and precautions you should take with your terminal, including basic housekeeping. It also describes the self test features of the terminal and some simple troubleshooting if you have a problem. Since there are no user-servicable parts on the terminal, these diagnostic tests are oriented to the user and do not require any technical experience.*
- 11-1 Maintaining The Terminal
- 11-1 Troubleshooting Terminal Problems
- 11-3 Terminal Self Test Procedures



## HDS3200 Owner's Manual

- 12-1 **Glossary** *A Glossary of terms used in this manual and in the computer environment follows.*

The *Appendices* include reference material to help you locate and use information about the terminal quickly and easily.

- 13-1 **Appendix A** -- *Compose Mode Operation*  
13-6 **Appendix B** -- *Character Set Diagrams*  
13-11 **Appendix C** -- *Printer Set Up Suggestions*  
13-22 **Appendix D** -- *HDS3200 ASCII And APL Terminal Differences*  
13-23 **Appendix E** -- *VT52 Mode Terminal Operation*  
*VT100 Mode Terminal Operation*  
13-24 **Appendix F** -- *Optional Video Output Connection*

### Quick Reference Guide

- 1 ANSI Text Mode Commands  
17 User Defined Key Keychart  
21 Terminal Processing Modes  
22 Graphics Mode Command Listing

**Index** *The Index lists key words and phrases and their location in the text of the manual.*

## Chapter 1

# Getting Acquainted With The HDS3200 Terminal

*SUMMARY Getting Acquainted With The HDS3200 Terminal*

*This chapter describes the terminal in general terms, including the optional features that are available. There are instructions for unpacking the terminal and setting it up, including drawings of various essential parts, such as the communications ports, the adjustment knobs, etc. A simple power-on test procedure is given.*

*There is a complete description of the terminal keyboard, including each keyboard group and its function. Each key and its operation is described.*

## The HDS3200 Terminal

The HDS3200 terminal represents a major step forward in terminal technology and human factors engineering. Probably the first thing you notice about the terminal is the large 15" diagonal screen. Advances in video technology mean that this large screen can produce high density character patterns with sharper focus than many smaller terminal screens. The improved readability is a feature you'll enjoy every time you use the terminal, and one you'll find very helpful for extended terminal use. This is especially valuable with the powerful graphics features available.

You'll notice also the compact size of the terminal and the keyboard, especially if you've used other terminals. The HDS3200 doesn't take over the whole desk and the keyboard doesn't push your papers to the side. The tilt and swivel features make the terminal comfortable to use.

The HDS3200 terminal keyboard is small, thin, and light, but has all the features you need. The separate keypads, touch indicators, full touch keytops, autorepeat, and solid touch response make this a keyboard that is easy to work with and that works with you. Other keyboard features, such as the LED indicators, the volume control for the keyclick and bell, bell enable/disable, etc. can offer you even more flexibility and choice.

The terminal is designed to integrate text and graphics operations for maximum efficiency. Setup Mode is a quick and easy way to select the terminal's configuration, and since the settings can be saved in permanent memory, you can go right to your work without worrying about configuration each time you turn on the terminal. The procedure for defining function keys is just about as easy as typing your name, so now you can use function keys easily instead of being intimidated by a series of complicated commands. Other features, like the front-mounted power switch, the external contrast and brightness controls, and the snap-in jacks for the keyboard cable make terminal set up and operation easier.

Human Designed Systems products have long been known for their extensive functional performance, and the HDS3200 continues that tradition. The HDS3200 has many capabilities that make it the terminal of choice for sophisticated users, including integrated text and graphics functions, multiple computer

## HDS3200 Owner's Manual

networking, windows, 25 and 50 line displays, additional pages of memory, multiple character sets and attributes, text editing features, printer buffer, etc.

The HDS3200 is an outstanding graphics terminal, having full compatibility with Tektronix 4010/4014 graphics standards. It can be used with mouse and digitizer tablet input, or with keyboard controls only. The HDS3200 Series has a full range of graphics commands and features, including selectable resolution (either 1056 x 400 or 1056 x 800, depending on the terminal model), two pages of selectable screen memory, up to 512K bytes of Display List memory for graphics data storage, graphics zoom and pan functions, and graphics quadrants for simultaneous display of all four Display Lists.

The local power of the HDS3200 is available through the on-screen calculator which is available for numeric operations on the terminal. The calculator uses the numeric keypad for entering numbers and a temporary pop-up section of the screen to display the entries and results. The results of these calculations can be sent directly to the host computer with a single keystroke.

There are a number of optional features available for the HDS3200 Series terminals: a third communications port, APL character set and functions, additional Display List memory, and different color monitor screens. Additional equipment includes a mouse for general use with the terminal. An *HDS3200 Programmer's Reference Manual* and an *HDS3200 Service Manual* are available for extensive and detailed information about the terminal.

The terminal's readability and effective human interface recommend the HDS3200 for all your needs, whether you need a simple, easy to use tool, or a sophisticated aid in developing your own applications.

### Terminal Models In The HDS3200 Series

There are three models of terminals in the HDS3200 series. They are listed below by their model numbers with a brief description of the features that distinguish them from one another.

**HDS3200 Model 10:** Integrated alphanumeric and graphics terminal, DEC VT220 and Tektronix 4014 compatible; graphics with 1056 x 400 screen resolution

**HDS3200 Model 20:** Model 10 with selectable 1056 x 800 screen resolution, 50 line mode, and other high resolution screen features

**HDS3200 Model 30:** Model 20 and additional graphics features such as zoom and pan functions, graphics quadrants, and four Display Lists.

This manual describes the HDS3200 features that all models have in common. Features of the individual models are described where appropriate. Some of the features mentioned are options or upgrades to particular models of the HDS3200 Series. If the features are available on your terminal, the lines controlling those features appear on the appropriate Setup Menu. If the features are not available, the Setup lines are not present.

The top line of the Setup Mode screen gives the model number of the terminal and the version number of the firmware currently in use.

### Unpacking the Terminal

The HDS3200 Terminal is packed securely in a carton with fitted foam end cap blocks. Open the carton, then tip it on its side so you can slide the terminal out on one of the foam end caps. When the terminal is out of the carton, lift off the top end cap, remove the keyboard from its slot, and lift the terminal carefully out of its recess in the bottom end cap. The power and keyboard cables are packed in one of the end cap pockets. Remove all the components from their protective plastic coverings.

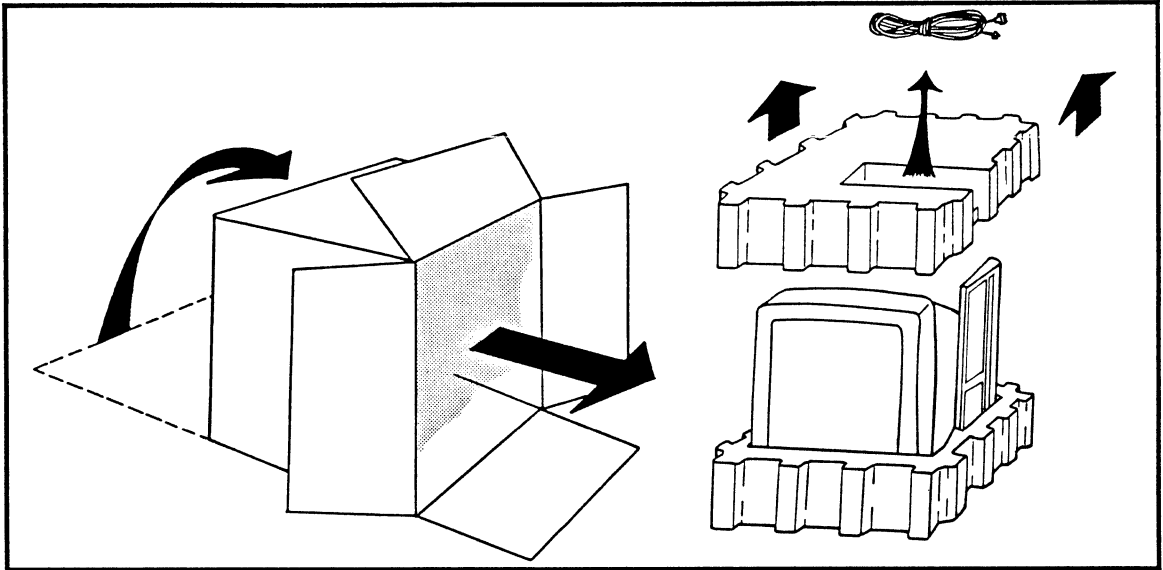

Inspect for any obvious damage. Place the terminal on your work surface or your desk. There should be sufficient room for you to turn and move the terminal a little while you make the necessary connections.

Plug in the keyboard. The keyboard cable has a telephone-style jack that snaps firmly into the front socket on the right side of the terminal base. If you happen to plug the keyboard jack into the joystick socket accidentally, you won't damage anything, but the keyboard won't work. Both sockets are labeled. Then plug the other end of the keyboard cable into the connector on the keyboard.

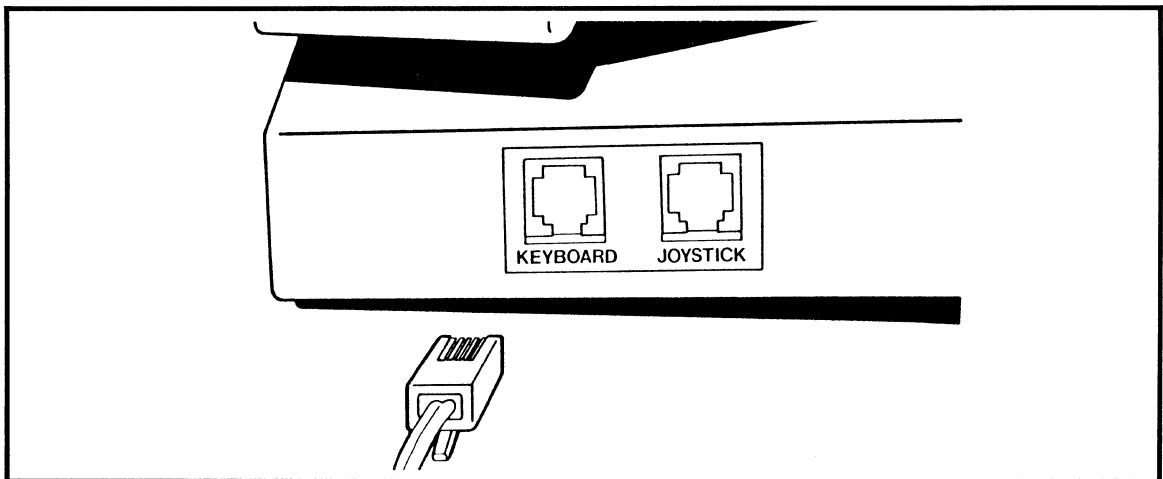

## HDS3200 Owner's Manual

Plug the power cord into the socket on the right side of the back panel. Make sure the terminal is turned Off, then plug the power cord into a grounded outlet.

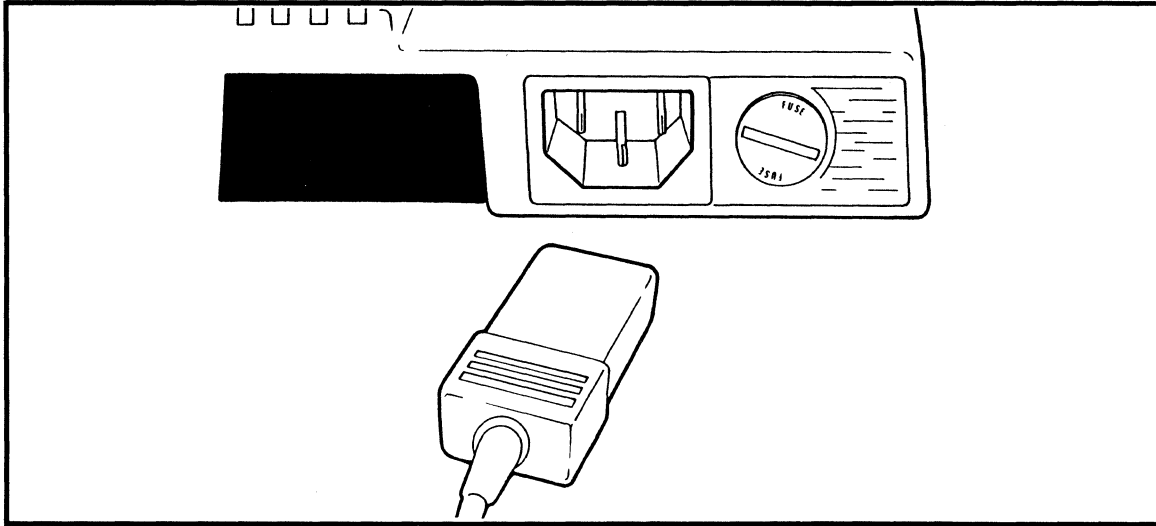

Turn On the terminal with the ON/OFF switch on the front panel (O marks Off, and | marks the On position). The power LED on the keyboard should turn On. The terminal should BEEP. Check the terminal by pressing the Setup key, which will display the Setup Menu on the screen. At this point you just want to check whether the terminal's working or not, so don't do anything while in Setup Mode. Press Setup again to clear the screen.

Check the brightness and the contrast of the display. Adjust the levels, if necessary, with the controls on the back of the monitor. If the terminal is inactive for about 20 minutes, the terminal's screen saver feature is activated.

This feature automatically dims the screen display to prevent screen burn in. Any keyboard activity will automatically bring the screen back to normal display brightness from the dimmed state.

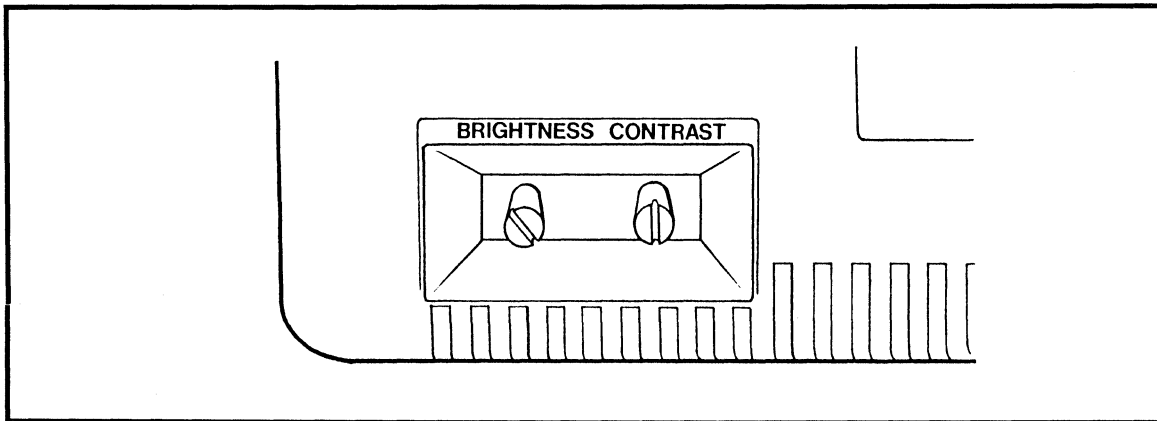

You probably also want to make some adjustments of the viewing angle (just lift the front edge of the monitor to the desired location), or the swivel of the screen depending on your work environment. The keyboard has adjustable tilt feet on the bottom.

## HDS3200 Owner's Manual

At this point you can work with the terminal a bit to become familiar with the keyboard and Setup Mode, or you can go to the communications section of Setup Mode and connect the terminal to the host computer and/or printer. If you make any connections, turn Off the terminal first.

### If The Terminal Doesn't Work....

If the terminal doesn't work, check a few things to see if you can identify the problem.

1. Make sure the outlet you used has power to it, and that the power cord is correctly plugged in, both to the wall and the terminal. Check that the keyboard is connected to the correct socket.
2. Make sure the fuse is good. The fuse is in a holder beside the power cord socket. Use a SLOW BLOW 250 V, 2 A, Type T fuse. The terminal uses a 1/4 x 1 1/4" (6.3 x 32 mm) fuse.
3. If the terminal didn't BEEP or the monitor doesn't show bright and dim screens when you adjust the brightness, contact the nearest HDS office or repair center. There are no parts inside the terminal that can be serviced by the user.

### The Terminal Keyboard

The keyboard supplied with your terminal is designed for efficient operation, including overall ergonomic design, key groupings for easy recognition and use, raised indicators for tactile location of key positions, and indicator lights for special functions, such as Lock, Comp Char, and Hold Scrn, which are described in detail later.

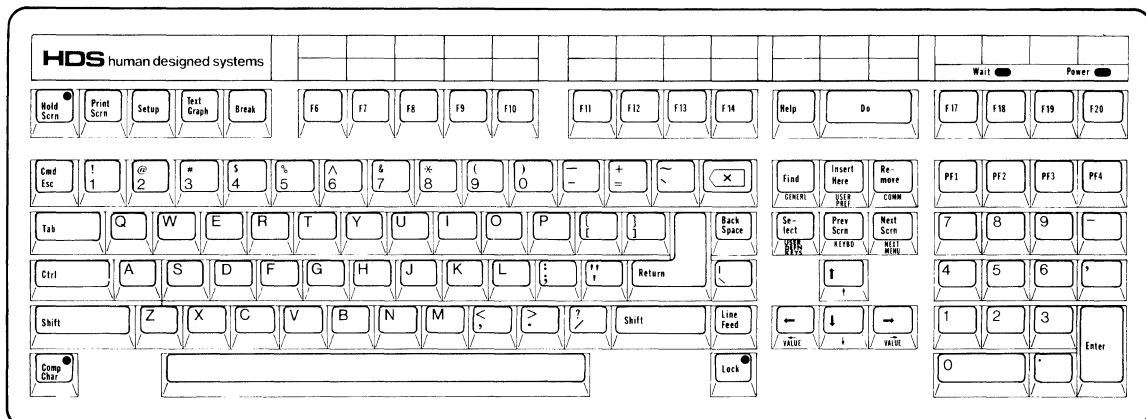

ASCII Keyboard Diagram

This section describes the operation of the keys as they are on the HDS3200 terminal, that is, in Local Mode, factory set configuration. You should be a little cautious about the following descriptions. Settings you make in Setup Mode can change some of these key functions. The application software you're using may also change the behavior of some of these keys. For instance, the Return key may act either as a carriage return or as a carriage return and line



feed (called a New Line), depending on a Setup Mode selection. The labels on many keys (such as the editing keys) apply only if particular application software is being used. As you read further, you'll learn how to set some of these functions.

### The Main Keyboard Group And The Numeric Keypad

The largest group of keys, the main keyboard group, is very much like a typewriter keyboard, although there are some characters that are generally used only on computers. Similarly, the numeric keypad is like the keypad on an adding machine. The design of these groups makes it easy for you to use your keyboard skills as you operate the terminal.

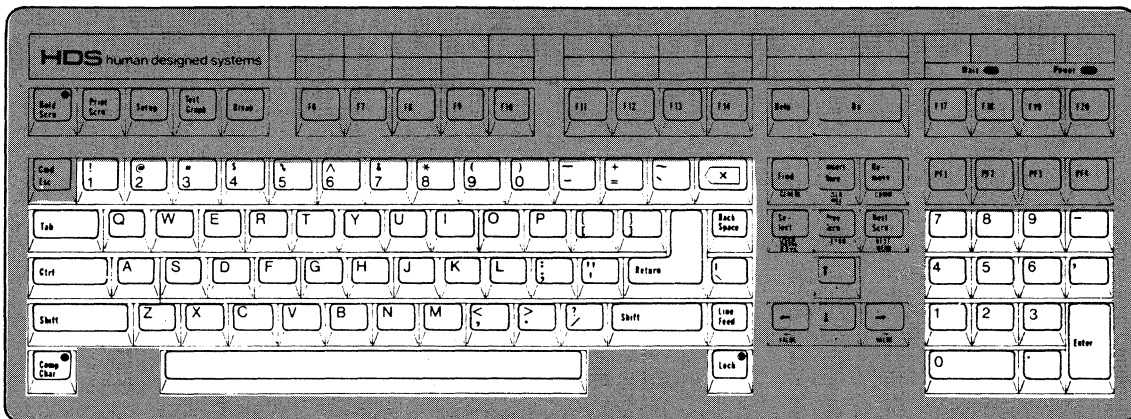

The keytops are labeled with the characters they produce. In the case of the alphabetic characters, only the uppercase letter is shown. The *Shift* key pressed with the letter key produces an uppercase letter or the upper character on the key; pressing the key alone produces a lowercase letter or the lower character. The *Lock* key selects the shifted version of main pad keys for every keystroke without using the *Shift* key. The LED is On when the Lock function is in use. A field in Setup Mode selects whether the *Lock* key applies only to alphabetic characters (called Caps Lock) or to all main pad keys like a typewriter's *Shift Lock* key. The Lock function does not apply to definitions already programmed on User Defined Keys.

The *Space* bar at the bottom of the main keypad displays a blank character and moves the cursor position one space to the right. The *Back Space* key moves it one space to the left. The *Tab* key moves the cursor position to the right to a previously determined point (the user can set the points, called tab stops). All this is pretty much like a typewriter keyboard.

The *Return* key is a carriage return, except the cursor stays on the same line. The *Line Feed* key moves down one line but stays in the same column. There is an option in Setup Mode which can set *Return* to generate a "New Line", which is both carriage return and line feed together.

The *Return* key is a good example of a key having different functions in different situations. *Return* is normally used by the terminal only as a carriage return. However, in some operating systems and application programs *Return* is also used as a command terminator, a signal to the computer that "this is the end of my command, execute it." In this role, *Return* is one of the most important and frequently used keys on the keyboard.

## HDS3200 Owner's Manual

The Control key (Ctrl) is also a very important key. Ctrl acts like a Shift key; that is, you hold it down while you press another key. Ctrl with another key produces a special character which doesn't appear on the screen but which sends a command to the computer or the terminal. This special character, called a control character, is shown as ^A or Ctrl A. Ctrl M, for instance, is the signal for a carriage return, and Ctrl J is the signal for a line feed. For convenience, these control codes have their own keys, but the terminal responds to Ctrl M exactly the same way it responds to Return.

The key in the upper right corner of the main keypad, labeled with an <X] in a left-pointing arrow, is a key unique to computer operation. This key generates a special non-printing character called a Rubout character, designated as ASCII code 127. This is also called the Delete key, but pressing the key doesn't necessarily delete anything. The Rubout character can be used to signal the computer to erase the previous character (which you may or may not see on your screen), but its operation usually depends on the operation of the software currently used. The Shift Delete key sends a Ctrl X character.

Esc, for Escape, is a special command introducer. Cmd, or Shift Esc, is used specifically for terminal commands sent from the keyboard. Esc and Cmd are usually the first characters of longer command sequences and are generally not used for other purposes. To repeat for emphasis, Esc commands go to the computer for operations there, and Cmd commands stay with the terminal for execution on the terminal.

The Comp Char key is for a special keyboard process to Compose Characters, generally international symbols that don't exist on regular keyboards. This process is described in detail, along with lists of permitted symbols, in **Appendix A** of this manual. The function of the the Comp Char key can be disabled in Setup Mode.

The Comp Char key is also used for some specific commands for the calculator and for graphics Zoom and Pan functions. These are described in detail in Chapter 6, *On-Screen Calculator*, and Chapter 7, *Graphics Zoom/Pan Operation*.

The Numeric keypad contains the numbers and arithmetic symbols arranged for rapid entry of numbers. The Enter key is normally the same as the Return key. The function keys PF1 to PF4 are considered part of the numeric keypad and are sometimes given special definitions by application programs. Keys in the numeric keypad have the same values shifted as unshifted, but the keypad can be set in Setup Mode into another mode of operation, called Application Mode, in which the keys have other definitions. Refer to Chapter 4, *User Defined Function Keys*, for details.

The On-screen Calculator uses the Numeric keypad for its operation, including the function keys F17 - F20, PF1 through PF4 and Help and Do. These keys and their operational definition in Calculator mode are described in detail in Chapter 6, *On-screen Calculator*.

### Local Operation Keypad

The five keys in the upper left Local Operation Keypad group are for the operation of some of the simple terminal functions.

## HDS3200 Owner's Manual

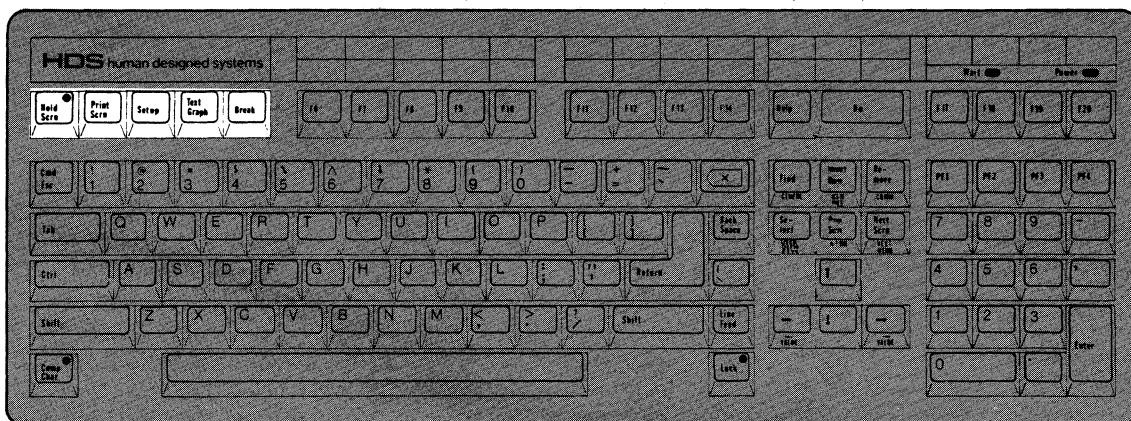

The Hold Scrn key stops the screen display so any new data is not immediately displayed. Pressing the key again resumes the normal display process and the screen displays the data from the point it was stopped. No data is lost by this process. The Hold Scrn key doesn't affect the actual communication process (XON/XOFF protocol must be On for Hold Scrn to work) but only the display on the screen. Data from the keyboard is stored but not processed while the Hold Scrn key is On. The LED in the key is On whenever the screen display is stopped.

The Print Scrn key sends the contents of the screen to the printer in either text or graphics mode operation. Ctrl Print Scrn toggles the Auto Print Mode function On and Off in text mode operation. The Auto Print function prints the current line of the screen whenever a line feed occurs, so the screen is printed continuously and incrementally as you work. If the printer is not available, the key commands don't work. If the printer is not ready, the commands will begin but then wait for the printer, so the terminal may appear to hang up. You can check the status of the printer port on the Status line of the Setup screen. If the Port shows "Not Ready", the print command can be cleared by the Clear Communications Ports command on the General Menu in Setup Mode.

The Setup key enters and exits Setup Mode, which is discussed with the other Setup Mode keys below. Setup Mode, and the Setup key will always work, even if the terminal is hung. (Special commands from the host computer can disable the Setup key. Turning the terminal Off and On will restore the Setup Mode function.)

Using Shift Setup toggles the display of a terminal Status Line at the bottom of the screen. The Status line reports the current settings for the cursor position, the window definitions, and the Host Port. These are discussed in more detail in Chapter 2, *Using the Terminal In Setup Mode*, and Chapter 10, *Multiple Computer Applications*. Commands from the host computer can substitute a Message line for the Status Line, or can relocate it from the bottom of the screen.

The Text Graph key is for switching from text to graphics mode operation and back. Pressing Text Graph switches the terminal from text operating mode to alpha mode of graphics operation. Using Shift Text Graph exits graphics mode and returns to text mode. Using Ctrl Text Graph enters alpha mode of graphics and clears the graphics screen. This key is active only on graphics terminals.

The Break key sends a signal to break communications. It sends a short break (300 ms) when unshifted and a long break (3.5 seconds, with DTR and RTS signals

## HDS3200 Owner's Manual

going low) when shifted. When the *Ctrl Break* key is pressed, the Answerback Message is sent to the host computer if it has been programmed by the user in Setup Mode. The function of the *Break* key can be disabled in Setup Mode.

### Setup Mode Keys

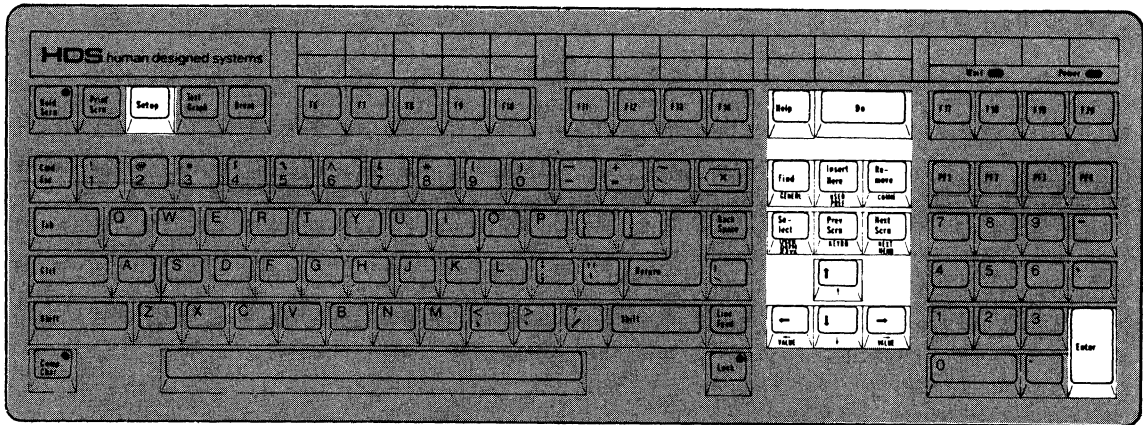

The *Setup* key, the keys in the Editing Keypad with blue keyfront labels and *Do* and *Help* are used in Setup Mode. When you press the *Setup* key to enter Setup Mode, the terminal is in a separate operating environment and the keys assume their Setup Mode functions. No other keys function while in Setup Mode.

The blue keyfront labels on the top two rows of keys correspond to the eight Setup Menu selections. The labels on the arrow keys move the line and option selection within the Setup Menu currently shown. The details of Setup Mode operation are discussed in Chapter 2, *Using The Terminal In Setup Mode*.

### User Defined Keys

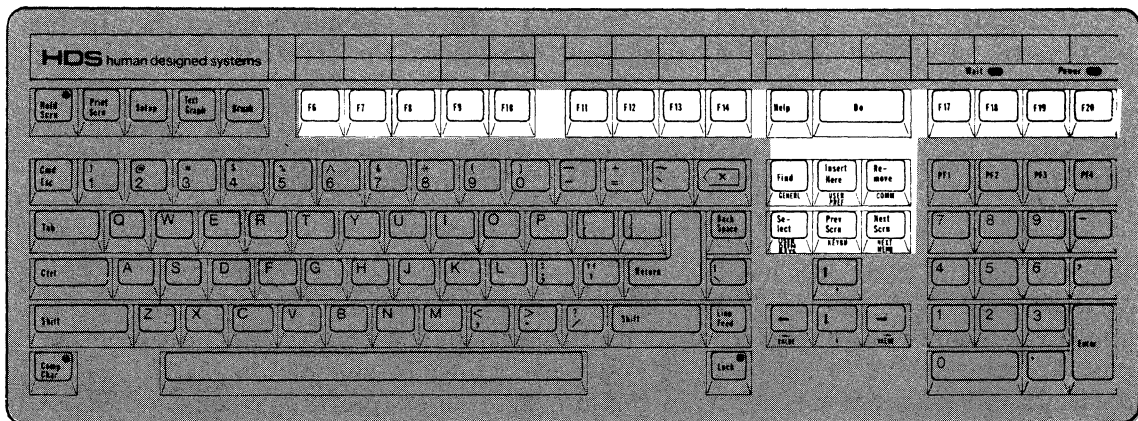

The keys along the top of the keyboard are called User Defined keys, or programmable function keys, first because they can be programmed (though that word implies more effort than is actually needed), and second because they can execute a function (a lot of characters) instead of just one character. Three separate sets of definitions may be given to the keys.

In their factory set configuration, the User Defined Keys have a simple definition that identifies them and their key numbers but has no functional application. The keys normally take their definitions from user definitions or from application programs. Instructions for programming the User Defined Keys are in Chapter 2, *Using The Terminal In Setup Mode*, and Chapter 4, *User Defined Function Keys*.

## Cursor Pad Keys

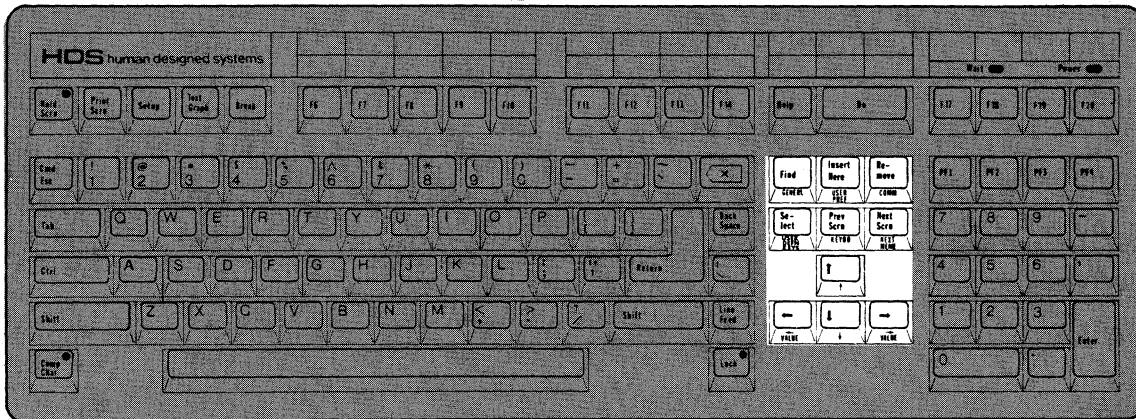

The keypad between the main pad and the numeric pad is the cursor keypad. In Normal Mode the keys with the arrows move the cursor in the direction of the arrows one space at a time. The *Shift up arrow* and *Shift down arrow* keys scroll one page (24 lines) of the screen (only if the window is greater than 24 lines). When used with the *Ctrl* key, the up and down arrows scroll one line of the screen.

The Cursor Pad keys may be set to Application Mode settings in Setup Mode. The definitions for the sequences they send while in Application Mode are found in Chapter 4, *User Defined Function Keys*.

In GIN mode of graphics operation the cursor control keys are active and move the crosshair cursor. The unshifted and *Ctrl* cursor keys move the crosshair one pixel position and the *Shift* and *Ctrl Shift* keys move the crosshair eight pixel positions.

The cursor keys are also used in graphics Zoom and Pan operations. Their functions and definitions are given in detail in Chapter 7, *Graphics Zoom/Pan Operation*.

The six editing keys, labeled *Find*, *Insert Here*, *Remove*, *Select*, *Prev Scrn*, and *Next Scrn*, are User Defined Keys whose actual operation is determined by the application software currently used by the terminal, with one exception. These keys are also active in Setup Mode and Zoom and Pan Definition Modes, with particular definitions described in the appropriate chapters.

In graphics operation the *Next Scrn* key clears the screen and enters Alpha mode of graphics from any other graphics mode. This key definition works only if you're already in Graphics mode operation. The *Next Scrn* key also has a special function, page clearing, with the Page Full option in Graphics Alpha mode.

### Keyboard Controls From Setup Mode

There are a number of keyboard functions that can be set in Setup Mode. These are listed here for reference and are described in detail in the appropriate sections of Chapter 2, *Using The Terminal In Setup Mode*.

- \* **Numeric Keypad Mode - Normal/Application** This selection controls the action of the keys in the Numeric keypad.
- \* **Cursor Keypad Mode - Normal/Application** This selection controls the action of the keys in the Cursor keypad.
- \* **Caps/Shift Lock** The Lock function may be set in Setup Mode to Lock alphabetic characters only (Caps Lock) or all keys (Shift Lock) to their uppercase values. The Lock key toggles this selected function On or Off.
- \* **Keyclick Volume** The volume of the keyclick can be adjusted.
- \* **Bell Volume** The volume of the bell can be adjusted.
- \* **Warning Bell** The terminal's response to the Bell command (CTRL G) can be turned On or Off.
- \* **Auto Repeat** The Auto Repeat feature of all keyboard keys may be turned Off.
- \* **Break Key** This key may be enabled/disabled.
- \* **Comp Char Key** This key may be enabled/disabled. Its use and the characters which can be composed with it are described in **Appendix A** of this manual. It is also used in graphics Zoom and Pan operations and in the operation of the Calculator.
- \* **Tab Stops** There are a number of commands to clear, set, or edit the Tab settings of the terminal, which determine the action of the Tab key.
- \* **Margin Bell** The margin bell can be enabled/disabled.



# HDS3200 Owner's Manual

Chapter 2

Using The Terminal In Setup Mode

*SUMMARY Using The Terminal In Setup Mode*

*This chapter describes Setup Mode and its use in operating the terminal efficiently. Definitions and explanations of the procedures and lists of the options are given, along with examples of typical applications.*

What Is Setup Mode?

Setup Mode is a separate operating capability of the terminal used for adapting the terminal configuration to your needs. In Setup Mode you have an easy way to examine and modify the terminal settings, with special keys assigned to help make the setup process simple and understandable. Setup Mode and the Setup key will always work, even if the terminal is hung.

Setup Mode is probably the single most important feature for you to use to operate your terminal successfully. Setup Mode allows you to choose the way your terminal operates in your environment, whether in communicating with the host computer, or displaying your data on the screen, or utilizing the special features of the terminal such as the User Defined Keys. You can use Setup Mode to choose the way these things are performed by the terminal, and then store those choices in NVM (Non Volatile Memory) so the terminal sets up the way you want it to each time you turn it On.

Using Setup Mode

Setup Mode uses keys specially marked with blue labels on the fronts of the keys -- the Setup key and keys in the cursor keypad marked Generl, User Pref, Comm, User Defn Keys, Keybd, Next Menu, and the Help and Do keys for the Graphics and HDS Extensions Menus, as well as Next Line, (left arrow - Value), (down arrow), and (right arrow - Value). When you're in Setup Mode, these keys operate as the blue labels indicate, not as the black keytop legends are marked, because Setup Mode is a separate operating environment for the terminal.

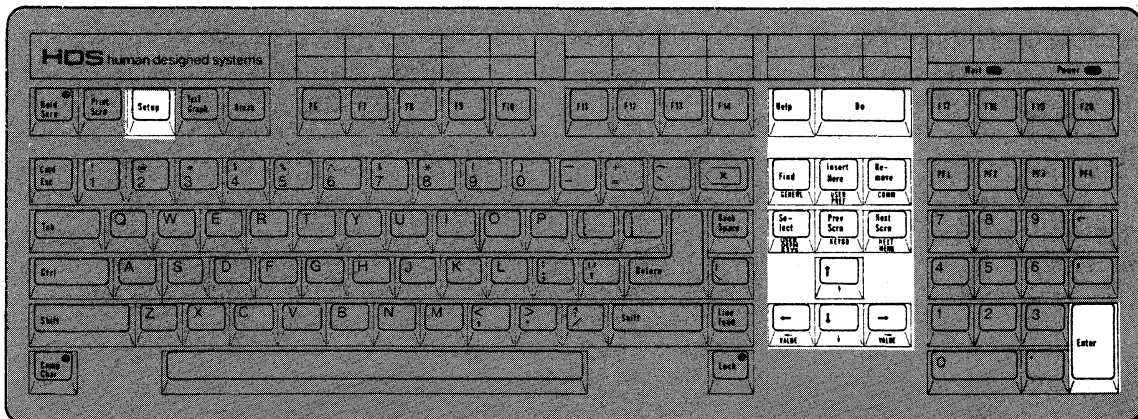

## HDS3200 Owner's Manual

You enter Setup Mode by pressing the key labeled Setup. The screen displays the first of seven Setup Mode Menus. The box in the upper right corner of the screen shows the seven menu selections and corresponds to the eight editing keys above the cursor keypad. You can select any other menu by pressing the appropriate key or by pressing the Next Menu key repeatedly.

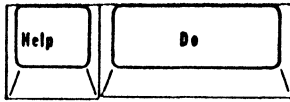

Graphics	HDs Extensions	
General	User Prefer.	Communi- cation
User Defn Key	Keyboard	Next Menu

Within each Setup Mode Menu, the items to choose are shown on an individual line or field. The current item to be chosen is shown with Bold display and an indicator line at the bottom of the screen. The up arrow and down arrow keys move from one line or one field to another. Try moving from one line to another by using the up and down arrow keys.

When the field is selected, the options or choices for that field appear in reverse video on the next-to-last line of the screen. For instance, the first field of the General Setup Mode Menu is On-Line/Local and the available options are shown as On-line and Local. The current selection is shown on the field indicator line. You can select one of the other options by pressing the left arrow or right arrow keys. The Enter key is an alternate key for these operations. The last value selected is the value used by the terminal for that option; if that is the value you want, just go to another line or exit Setup Mode.

Some fields, like Clear Text Display, execute a command instead of letting you choose options. In this case, the left arrow or right arrow keys execute the command and the indicator line signals the fact by displaying "Done".

To familiarize yourself with Setup Mode, try using a few of the menu selection keys and moving the field lines up and down to see which options are available. For now, don't make any changes in the options until you understand what each option means.

You can exit Setup Mode any time by pressing the Setup key. The next time you enter Setup Mode, you'll enter at the same Menu and field line you were using when you left Setup Mode.

(Setup Mode can be disabled on the terminal by using a special command from the host computer. This would normally be done only in installations where the terminal's configuration was preset and modifications were not permitted. Since the disabling of Setup Mode is a setting that is not saved in Non Volatile Memory, turning the terminal Off and On will restore the Setup Mode function.)

### Using The Mouse In Setup Mode

The HDS Mouse is a quick and convenient tool to use in Setup Mode. The up and down movement of the mouse selects lines from the screen menu; left and right movements are ignored. The mouse buttons have special Setup Mode definitions: the Middle button selects the Next Menu, and the Left and Right buttons act like the left and right arrow keys by selecting the different options for each Setup line. The mouse is not used in Setup Mode fields where data entry is needed, such as the User Defined Keys or Window Definitions.

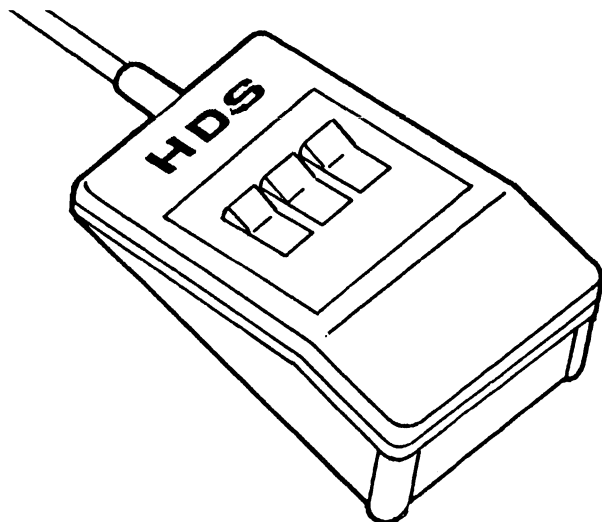

The Tab Settings field is very easy to use with the mouse. When you are editing Tabs, the left and right movement of the mouse moves the cursor along the tab line and the Left and Right buttons toggle the Tab setting at the cursor position. The Middle button functions like the up arrow key and exits the Tab editing field.

### Saving Setup Mode Configurations

When you make a change in Setup Mode, that change is effective immediately. For instance, if you change the "Columns Displayed" field in the User Preference Menu from: 80 to 132 columns, that change is immediate. When you exit Setup Mode, the setting is in effect. The settings remain in effect until changed again from Setup Mode or the terminal is reset to its NVM settings. This is done either with the "Recall Settings from NVM (Hard)", which is a Hard Reset command, or the "Reset NVM to Factory Defaults" commands in Setup Mode. When the terminal is turned On, it automatically recalls its NVM settings.

If you want to save the terminal configuration you selected in Setup Mode, you can use the "Save Settings into NVM" command in the General Menu of Setup Mode. This saves all the Setup Mode selections (except Cursor and Numeric Keypad settings) in Non Volatile Memory so they are used whenever the terminal is turned On, or whenever the NVM settings are recalled. The "Reset NVM to Factory Defaults" command replaces the current NVM settings with the original factory settings, then resets the terminal, which brings the (factory default) NVM settings into operation.

**General Setup Menu**

HDS3200-30 Setup Mode - Version 0.0

To Choose      Use  
 . Setup menus . Editing keys,Do,Help  
 . Next fields . Up or down arrow keys  
 . Next values . Left or right arrow keys

Graphics	HDS Extensions	
General	User Prefer.	Communi-cation
User Defn Key	Keyboard	Next Menu

```
> On-Line/Local.....On-Line.....>
Clear Text Display
Clear Communications Ports
Reset Terminal (Soft Reset)
Recall Settings from NVM (Hard)
Save Settings into NVM
Reset NVM to Factory Defaults
Control Code Processing          Interpret
Terminal Mode                   VT220, 7-bit
Terminal ID (VT100/VT200 Mode)  VT220/220
Clear All Tab Stops
Reset Tabs to Every 8 Columns
Edit Individual Tab Stops

Options: On-Line; Local
Replace      Ready          Ready          Ready          1
```

The General Setup Menu allows you to choose a number of basic terminal settings, or execute several important commands to reset the terminal configuration. Notice that the Setup screen gives you the model number of the terminal as well as the version number of the firmware currently in use. It also has a current status line at the bottom of the screen which has fields for Insert mode (either Insert or Replace), the current status of all three ports (either Ready, Not Ready, or None), and the current window (numbers 1 to 6 or Message).

The Setup Mode fields are:

- \* **On-Line/Local** This selects the mode of operation of the terminal, whether "On-line" and communicating with the host computer, or "Local", in which data entered at the keyboard is displayed only on the terminal screen and not sent to the communications Port. In Local Mode all data and commands coming from the host are stored without processing.
- \* **Clear Text Display** This field executes the command to clear the text memory of the terminal when you exit Setup Mode.
- \* **Clear Communications Ports** This field executes the command to clear communications on all ports. For example, this might be used to clear the terminal when it is hung after an unsuccessful *Prnt Scrn* command, or to reset the mouse or digitizer port. The technical effects of this command are to disconnect communications at the port, abort print operations and escape sequences, take the terminal out of printer controller mode, clear all input/output buffers, and clear the incoming XOFF switch used by the XON/XOFF protocol (if it is enabled) and send an XON to the host communication line. The current communications status of the Ports is given at the bottom of the screen. The current host Port is shown in bold display. Check to see if the Port is "Ready" or "Not Ready".

- \* **Reset Terminal (Soft Reset)** This field executes a Soft Terminal Reset command. The effect of this command is to change many of the screen and keyboard functions to their normal state but leave the data in display memory unchanged. For instance, the Numeric and Cursor Keypad settings are set to Normal; the character sets, visual display attributes, and erase attributes are returned to their factory settings; the terminal is set to Replace Mode; auto wrap is set Off; and the scrolling region is defined as the entire display window.
- \* **Recall Settings from NVM (Hard)** This field executes a Hard Terminal Reset. The effect of this command is to erase the contents of display memory and recall the terminal configuration as set in NVM. Generally, this command is the same as turning the terminal Off, then On again.
- \* **Save Settings into NVM** This field executes a command to save all Setup Mode selections (except Numeric and Cursor Keypad settings) in Non Volatile Memory. These NVM settings are then used whenever the terminal is turned On, or the Recall Settings from NVM command is given.
- \* **Reset NVM to Factory Defaults** This field executes a command to return the terminal configuration to the original factory settings. This command replaces the NVM settings with the original factory settings, then executes a Recall Settings from NVM command to set the terminal configuration to those NVM settings.
- \* **Control Code Processing** This field allows you to select the type of processing for control codes. The Interpret option is for normal terminal operation in which all controls and commands are processed. The Display option does not process the control codes sent or received from the communications Port as commands but simply displays them on the screen as characters from the ASCII or Multinational character sets. Line Feed, Form Feed, and Vertical Tab codes are also processed as a newline command. Autowrap Mode is also assumed. The Display option of Control Code Processing is often called Transparent Mode and is used for debugging purposes when it is important to see the identity and sequence of commands received by the terminal.
- \* **Terminal Mode** This field selects the basic terminal operating mode. A Soft Reset Terminal command (see above) is performed each time a new value is selected. The options available are: VT52, which is for the emulation of DEC VT52 terminal; VT100, which is for the emulation of DEC VT100 terminal; VT220 7-bit operation, which is for all VT220 functions and with C1 control codes sent as 7-bit ESC sequences; VT220 8-bit operation, which is for all VT220 functions and with C1 control codes sent as 8-bit sequences; and Graphics, which is for Tektronix 4010/4014 terminal emulation. If you are using several application programs that use different settings, be sure to make the settings before you enter the application program, not during the program.
- \* **Terminal ID (VT100/VT200 Mode)** This field selects the terminal's response to the ANSI Transmit ID command. These responses are determined in part by the "Terminal Mode" selection made in the previous field. If the terminal mode is VT220, all responses are VT220, regardless of the VT100 settings. If the terminal mode is VT100, the various VT100 options apply. If the HDS option is chosen, the HDS response is used for all terminal mode selections. VT52 mode sends a VT52 mode response only. The options available are:



## HDS3200 Owner's Manual

VT100/220 - Identifies terminal as DEC VT100 or VT220

VT101/220 - Identifies terminal as DEC VT101 or VT220

VT102/220 - Identifies terminal as DEC VT102 or VT220

VT220/220 - Identifies terminal as DEC VT220

HDS/HDS - Identifies terminal as HDS3200. This response indicates the presence of graphics and/or HDS options and the firmware version.

\* **Clear All Tab Stops** This field executes the command to remove all tabs.

\* **Reset Tabs To Every 8 Columns** This field executes the command to return to the factory default tab stop settings, which was a tab stop in each 8th column.

\* **Edit Individual Tab Stops** This field allows the user to execute commands to edit the current tab stop settings according to the following procedure:

Press the left arrow or right arrow keys to display the current Tab settings. Then use the left arrow or right arrow keys to move the cursor to the position you want to add or delete a Tab setting. Press the Enter key to toggle the Tab setting at that position. The up arrow or down arrow keys exit the Tab editing mode. The Setup and eight editing keys still perform their regular Setup Mode functions. The mouse is convenient for editing tabs. Left and right movements move along the tab line and the Left and Right buttons toggle the tab setting at the cursor position. The Middle button exits Tab editing.

### User Preference Setup Menu

HDS3200-30 Setup Mode - Version 0.0

To Choose	Use
. Setup menus	. Editing keys, Do, Help
. Next fields	. Up or down arrow keys
. Next values	. Left or right arrow keys

Graphics	HDS Extensions	
General	User Prefer.	Communication
User Defn Key	Keyboard	Next Menu

```

> Columns Displayed.....80.....>
  Lines Displayed          25
  Clear Screen on 80-132 Change  Yes
  Auto Wraparound         No
  Scrolling                Jump
  Screen Video             Normal
  Cursor Style             Fast Block
  User Features            Unlocked
  New Line Mode           No
  Form Feed Processed As  Line Feed
  Margin Bell             No
  
```

```

Options: 80; 132
Replace      Ready          Ready          Ready          1
  
```

This Setup Menu shows a number of user selectable features of terminal operation.

\* **Columns Displayed** This field selects the number of columns displayed by the text screen. The options are 80 columns or 132 columns. The screen display isn't changed until you exit from Setup Mode.

## HDS3200 Owner's Manual

- \* **Lines Displayed** This field selects a screen display of 25 lines or 50 lines. The 50 line screen allows you to double the number of lines of text shown at one time by decreasing the size of the text characters. This feature is available only on terminal models which have high resolution graphics screens. If this setup line does not appear, your terminal doesn't have this option.
- \* **Clear Screen on 80-132 Change** This field selects whether the change between different screen column displays erases the data on the screen or not. The options are to clear the screen (the Yes choice) or to preserve the data (the No choice).
- \* **Auto Wraparound** This field selects how data is handled at the end of a line. The options are Yes and No. The Yes option chooses auto wraparound so text automatically wraps to a new line at the end of the previous line. With the No option characters added at the end of the line overwrite previous characters in the last column until a Carriage Return/Line Feed is received.
- \* **Scrolling** This field selects the type of scrolling used by the terminal. The options are jump scrolling, smooth scrolling, or slow smooth scrolling.
- \* **Screen Video** This field selects the appearance of the entire screen display, either: Normal, with a dark screen and light characters, or Reverse, with a light screen and dark characters. This field affects the terminal in all settings, all windows, and both text and graphics modes.
- \* **Cursor Style** This field selects the type of cursor displayed by the terminal, either a block or an underline, with either fast, regular, or no blink. The choices include: None, fast-block, fast-line, blink-block, blink-line, block, or line.
- \* **User Features** This field governs whether or not the host computer can change the following user-selected features: Auto Repeat, Scroll type, Screen video, Tab stops, and the Keyboard Lock state. The setup field options include either Unlocked or Locked.
- \* **New Line Mode** This field determines the handling of Carriage Return and Line Feed characters by the terminal. The options are No, which means there is no special handling, or Yes, which means that a Carriage Return from the keyboard is handled as a CR/LF, and that a LF from the host computer is handled as CR/LF.
- \* **Form Feed Processed As** This field determines the action of the terminal when it receives a Form Feed character (Ctrl L). The options are: Line Feed, the terminal executes a Line Feed when it receives a Form Feed; or Clear Screen, in which the terminal clears the screen and homes the cursor when it receives a Form Feed.
- \* **Margin Bell** This field selects whether the margin bell is used or not. The No option has no margin bell. The Yes option uses the margin bell and sets the bell to sound 8 columns before the right margin.

The following field appears only on terminals with the APL option.

- \* **APL/ASCII Mode** This field selects the operating mode of the terminal. The ASCII option selects the ASCII character set in G0 (the default character set), and uses regular character processing. The APL option selects the APL character set for G1 and uses overstrike processing for characters.

# HDS3200 Owner's Manual

## Communications Setup Menu

HDS3200-30 Setup Mode - Version 0.0

To Choose	Use
. Setup menus	. Editing keys, Do, Help
. Next fields	. Up or down arrow keys
. Next values	. Left or right arrow keys

Graphics	HDS Extensions	
General	User Prefer.	Communication
User Defn Key	Keyboard	Next Menu

```

> Port Number.....1.....>
  Transmit Speed          9600
  Receive Speed          -Transmit
  XON/XOFF Control       XOFF at 64
  Clear to Send Needed for Transmit No
  Data/Parity            8/None
  Parity Checking of Input No
  Stop Bits              1
  Local Echo             No
  Limit Transmit Rate    Yes
  
```

Options: 1; 2; 3  
 Replace            Ready                    Ready                    Ready                    1

The Communications Setup Menu consists of three separate menus, one for each port. The individual menus are selected by choosing the port number in the first field. The settings for each menu apply only to that port, so each port can have different communications settings and protocols, etc. The settings that appear on the Setup Menu are for the Port selected on the top line. The Menu for Port 2, usually the printer port, has some additional fields needed for selecting printer options. The Menu for Port 3 includes two lines for setting up the mouse or digitizer tablet.

HDS3200-30 Setup Mode - Version 0.0

To Choose	Use
. Setup menus	. Editing keys, Do, Help
. Next fields	. Up or down arrow keys
. Next values	. Left or right arrow keys

Graphics	HDS Extensions	
General	User Prefer.	Communication
User Defn Key	Keyboard	Next Menu

```

> Port Number.....2.....>
  Transmit Speed          9600
  Receive Speed          -Transmit
  XON/XOFF Control       XOFF at 64
  Clear to Send Needed for Transmit Yes
  Data/Parity            8/None
  Parity Checking of Input No
  Stop Bits              1
  Local Echo             No
  Limit Transmit Rate    No
  Printer Mode           Normal
  Printing Extent        Entire Page
  Print Terminator       None
  Printed Data Type      National
  
```

Options: 1; 2; 3  
 Replace            Ready                    Ready                    Ready                    1

# HDS3200 Owner's Manual

HDS3200-30 Setup Mode - Version 0.0

To Choose      Use  
 . Setup menus . Editing keys,Do,Help  
 . Next fields . Up or down arrow keys  
 . Next values . Left or right arrow keys

Graphics	HDS Extensions	
General	User Prefer.	Communi- cation
User Defn Key	Keyboard	Next Menu

```

> Port Number.....3.....>
  Port 3 Input from      Mouse
  Mouse Active           Graphics
  Transmit Speed         2400
  Receive Speed          -Transmit
  XON/XOFF Control       XOFF at 64
  Clear to Send Needed for Transmit No
  Data/Parity            8/Odd
  Parity Checking of Input No
  Stop Bits              2
  Local Echo             No
  Limit Transmit Rate    Yes
    
```

Options: 1; 2; 3  
 Replace            Ready                      Ready                      Ready                      1

The details of the field selections and information necessary to help you make the choices for a communications configuration are contained in Chapter 3, *Setting Up Communications With The Computer*.

## User Defined Key Setup Menu

HDS3200-30 Setup Mode - Version 0.0

To Choose      Use  
 . Setup menus . Editing keys,Do,Help  
 . Next fields . Up or down arrow keys  
 . Next values . Left or right arrow keys

Graphics	HDS Extensions	
General	User Prefer.	Communi- cation
User Defn Key	Keyboard	Next Menu

```

> Program Permanent (NVM) UDK.....>
  Program Temporary (RAM) UDK

  User Defined Key Programming      Unlocked
  Reset temporary defn to default
  Reset all definitions to default

  Function Key Sets                      1
  Use Function Key Set                    1
    
```

Press left or right arrow to perform action  
 Replace            Ready                      Ready                      Ready                      1

## HDS3200 Owner's Manual

The User Defined Key Setup Menu allows you to enter new definitions and to edit current definitions for the 21 User Defined Keys in both their shifted and unshifted states in any of the three sets. The three buttons on the mouse may also be programmed. The definitions appear in a reverse video block on the Menu screen and the editing instructions appear on the reverse video Options line at the bottom of the screen.

The User Defined Key Setup Menu also contains a field for Locking the current definitions so they cannot be modified by the host computer. There are also fields which execute commands to reset either the temporary definitions to factory settings or to reset all the definitions to the original settings.

Three separate sets of User Defined Keys may be programmed. The Setup Menu contains two fields that control this feature. The first field selects whether one set of keys or three sets are used, and the second field controls which of the three sets is used when using the three-set configuration.

For more details on the User Defined Keys Setup Menu and the operation of the User Defined Keys, refer to Chapter 4, *User Defined Function Keys*.

### Keyboard Setup Menu

HDS3200-30 Setup Mode - Version 0.0

```
To Choose      Use
. Setup menus  . Editing keys,Do,Help
. Next fields  . Up or down arrow keys
. Next values  . Left or right arrow keys
```

Graphics	HDS Extensions	
General	User Prefer.	Communi- cation
User Defn Key	Keyboard	Next Menu

```
> Numeric Keypad Mode.....Numeric.....>
Cursor Keypad Mode          Normal
Caps/Shift Lock             Caps Lock
Keyclick Volume             Normal
Bell Volume                  Normal
Warning Bell (Response to ^G) Bell
Auto Repeat Mode            Yes
BREAK Key                    Enabled
COMP CHAR Key                Enabled
Edit Answerback Message
Concealed Answerback Message No
```

```
Options: Numeric; Application
Replace      Ready          Ready          Ready          1
```

The Keyboard Setup Menu contains a number of fields controlling the function of various keyboard operations and keyboard keys.

\* **Numeric Keypad Mode** This field selects what definition the numeric pad keys transmit when they are pressed. There are two options: Numeric Mode, in which the keys send out the number or character appearing on their keytop label; or Application Mode, in which the keys send out an escape sequence. The exact sequence for each key is shown in the Keychart in Chapter 4, *User Defined Function Keys*.

The setting for this field is not saved in NVM.

## HDS3200 Owner's Manual

\* **Cursor Keypad Mode** This field selects what definitions the cursor pad keys transmit when they are pressed. There are two options: Normal Mode, or Application Mode. The exact sequence for each key is shown in the Keychart in Chapter 4, *User Defined Function Keys*.

The setting for this field is not saved in NVM.

\* **Caps/Shift Lock** This field specifies the function performed by the Lock key. The Caps Lock option sets the shifted state for all alphabetic characters, but the rest of the keyboard is treated normally (the shifted key value for non-alphabetic characters requires the Shift key). The Shift Lock option sets the shifted state for all main pad keys. User Defined Keys and other keys with shifted values are not affected. The Lock key toggles the selected function On and Off. The LED on the Lock key is lit when the chosen mode is in operation.

Note that this setting chooses the operation of the Lock key when it is pressed, and may have no immediate effect when you exit Setup Mode. Lowercase characters in the User Defined Key definitions are unaffected by the Lock function.

\* **Keyclick Volume** This field allows you to select the loudness of the click the keys produce when pressed. The options include: Off, Soft, Normal, or Loud.

\* **Bell Volume** This field allows you to select the loudness of the keyboard bell. The options include: Off, Soft, Normal, Loud, or Video (flashing screen) bell.

\* **Warning Bell (Response to ^G)** This field selects whether the terminal responds to Bell (Ctrl G) commands or not. The options are: Off and On. The use of the bell for error messages, etc. is unaffected by this setting.

\* **Auto Repeat Mode** This field selects whether keyboard keys use the auto repeat feature when they are held down. The options are: Yes (all keys use auto repeat) or No.

\* **BREAK Key** This field selects whether the Break key functions when it is pressed. Options are: Enabled or Disabled.

\* **COMP CHAR Key** This field selects whether the Comp Char key functions when it is pressed. The options are: Enabled or Disabled. The use of the Comp Char key in Zoom and Pan Definition Modes and in Calculator Mode is unaffected by the Disable option.

\* **Edit Answerback Message** This field enters an editing menu for the Answerback Message. Editing commands (the same as for User Defined Keys) appear on the reverse video options line at the bottom of the screen. The current Answerback Message appears in a reverse video block. If the Answerback Message was concealed, the word <Concealed> appears on the definition line. It disappears if new text is entered. Storing a new Answerback Message automatically makes it unconcealed.

\* **Concealed Answerback Message** This field determines whether the Answerback Message can be displayed in Setup Mode or not. The options are: Yes or No.

Note that once an Answerback Message has been concealed, it cannot be unconcealed except by re-entering it.

# HDS3200 Owner's Manual

## Graphics Setup Menu

HDS3200-30 Setup Mode - Version 0.0

To Choose      Use  
 . Setup menus . Editing keys, Do, Help  
 . Next fields . Up or down arrow keys  
 . Next values . Left or right arrow keys

Graphics	HDS Extensions	
General	User Prefer.	Communi- cation
User Defn Key	Keyboard	Next Menu

```
> Clear Graphics Display.....>
Graphics/Text Overlay            No
Graphics Resolution            Medium
Graphics Printer                LA75
Graphics GIN Mode Terminator    CR
Page Full                        Off
Select Graphics Page            1
Print Buffer                      No
Display List data logging        Yes
Graphics Quadrant Mode          No
Select Display List/Quadrant    1
```

Press left or right arrow to perform action  
 Replace            Ready            Ready            Ready            1

HDS3200 terminals have a number of different graphics configurations for Model 10, Model 20, and Model 30. All of the fields are listed below. The shaded area of the illustration indicates optional features which may not be available on all models. The particular graphics features available on the model you have are shown on the Setup Menu on your terminal. Notice that the mouse and digitizer tablet selection appears on the Port 3 Communications Setup Menu.

- \* **Clear Graphics Display** This field executes the command to clear the graphics memory. Text memory is unaffected.
- \* **Graphics/Text Overlay** This field controls which display memory appears on the screen. The options include: Yes, which means that both graphics and text memory contents are shown on the screen simultaneously, or No, which means that only the memory of the operating mode currently selected (text or graphics) is displayed.
- \* **Graphics Resolution** This field selects the screen resolution of the HDS3200 terminal, and depends on the terminal model you have. This field is available only on high resolution terminals. The options are: Medium, which selects 1056 x 400 pixel resolution; or High, which selects 1056 x 800 pixel resolution for the screen.
- \* **Graphics Printer** This field controls how graphics data to be printed is formatted and sent out. The options select various printers which use particular graphics printing conventions. The choices of printer type include: LA75 (DEC), FX80 (Epson), C.Itoh, Anadex, Okidata, Thinkjet (HP), or Laserjet II (HP).

Refer also to **Appendix C** of this manual for additional suggestions and tables for setting up these printers for correct communication with the terminal.

## HDS3200 Owner's Manual

- \* **Graphics GIN Mode Terminator** This field selects the character or characters to be sent by the terminal after exiting GIN mode or after executing a status command. The options include: None, CR, CR/LF, or CR/EOT characters. CR is the factory setting and the most common selection.
- \* **Page Full** This field controls the overwriting of characters in Graphics Alpha mode. The options include: Off, Margin 1, and Margin 2. Off permits the characters to fill the screen with no automatic control. The Margin 1 and Margin 2 settings cause the terminal to execute a "Hold Screen" function (with the XON/XOFF protocol) when the margin is reached. When the margin is reached, the screen can be cleared with the *Next Scrn* key which also resumes the display of characters, or the *Hold Scrn* key which only resumes the display. This setting is saved in NVM. A more complete discussion is found in Chapter 5.
- \* **Select Graphics Page** This field determines which page of graphics screen memory is used for storage and display of a screen image, either page 1 or page 2. This selection is available only on terminals with high resolution screens when they are operating in medium resolution mode.
- \* **Print Buffer** This field allows you to use part of the graphics display list memory as a printer buffer. The options available are: No, where no memory is used; 64K, or 128K, where that number of bytes of the display list memory is dedicated for the printer buffer. This option is available only on terminals which have graphics display list memory. Note also that the amount of display list memory is optional up to 512K.
- \* **Display List Data Logging** This field selects whether data received is logged into the graphics display list memory or not. The options are No, for no data logging, and Yes. This field is available only on terminals which have graphics display list memory. This is discussed in more detail in Chapter 9, *Advanced Graphics Concepts*.
- \* **Graphics Quadrant Mode** This field selects a quick method of displaying the graphics content of all four display lists at the same time by displaying them in four boxes, one in each quadrant of the screen. The options are No, for no graphics quadrant display, or Yes. This field is available only on terminals which have graphics display list memory.
- \* **Select Display List/Quadrant** This field selects which of the display lists (1, 2, 3, or 4) should be used for data logging. This field is available only on terminals which have graphics display list memory.

### HDS Extensions Setup Menu

These HDS3200 terminal features are extensions beyond DEC VT220 capabilities. The Setup Menu shows these fields, and brief descriptions follow, but details of their operation and examples of their usefulness are given in Chapter 10, *Multiple Computer Applications*. These features are generally for advanced terminal users and involve computer networking and showing multiple computer displays on the terminal screen simultaneously.



# HDS3200 Owner's Manual

## HDS Extensions Setup Menu

HDS3200-30 Setup Mode - Version 0.0

To Choose      Use  
 . Setup menus    . Editing keys, Do, Help  
 . Next fields    . Up or down arrow keys  
 . Next values    . Left or right arrow keys

Graphics	HDS Extensions	
General	User Prefer.	Communi- cation
User Defn Key	Keyboard	Next Menu

```

> Host Computer is on Port.....1.....>
  Select Current Window                    1

  Define Window
  - memory lines                            001 to 024
  - memory columns                         001 to 080
  Displayed on Screen Lines               001 to 024

  Cursor always visible                    Yes
  Reset all Windows to Default
  Window video                             Normal
    
```

Options: 1; 2; 3  
 Replace            Ready                    Ready                    Ready                    1

\* **Host Computer Is On Port** This field allows you to specify which port is used as the "main" computer port. The selected port is shown on the field line and is also shown in bold display on the status line at the bottom of the screen.

The options are:

- 1 - Selects port one as the host computer port
- 2 - Selects port two (normally the printer port) as the host computer port
- 3 - Selects port three (normally the mouse port) as the host computer port.

\* **Select Current Window** This field selects the current window for the Host or the window being defined. The options are: 1 up to 6, or the maximum number for the host.

\* **Define Window - Memory Lines - Memory Columns** These lines allow you to define the current window, from beginning to end line and from beginning to end column. For lines the minimum is 1 and the maximum is 96. For columns the minimum is 1 and the maximum depends on the defined screen width (80 or 132). The user must keep track of the definitions since the terminal will permit window definitions to overlap.

\* **Displayed on Screen Lines** This field selects the lines on the screen (in the range of 1 to 25, or in 50-line mode lines 1 to 50) where the contents of the window should be displayed. The user must keep track of the definitions since the terminal will permit screen line definitions to overlap. The screen line definition given to the currently selected window will take precedence over other definitions.

\* **Cursor Always Visible** This field selects the display of the cursor within the window. The window can be displayed on the screen so the cursor is always visible, which means the text is scrolled so the area of the window displayed contains the cursor (the Yes option). The window can also be displayed as a fixed group of lines on the screen, regardless of the position of the cursor (selected by option No).

\* **Window Video** This field selects the display of the window as Normal or Reverse video. This selection applies only to the contents of the window selected and its display area on the screen. Note also that other Normal and Reverse display options, such as the Screen Video option on the User Preference Setup Menu and individual graphic rendition settings for characters, can affect this display.

\* **Reset All Windows to Default** This field cancels all window and screen range definitions and returns the terminal to its default window configuration.

### Terminal Status Lines

A Status Line is a screen line which displays the current settings of a number of terminal functions. The Status Line is available by pressing the *Shift Setup* key. There are two Status Lines, one for ANSI text mode and another for Graphics mode operation. The Status Line for the current operating mode is displayed on the bottom line of the screen in reverse video.

The ANSI text mode line displays the following information:

Host:x Cursor:xx;yyy Window x: Lines xx-yy Cols xxx-yyy Screen Lines xx-yy

This data refers to the current host selected (see the Host is on Port Setup Line of the HDS Extensions Menu); the current cursor position; the current window selected, its definition and its screen lines for display (see the HDS Extensions Menu to make these definitions). The meaning of this data is discussed in Chapter 10, *Multiple Computer Applications*.

This Status Line is in addition to the current status line which appears at the bottom of the screen when the terminal is in Setup Mode. The current status line gives the setting for Insert Mode (Insert or Replace), the current communications status of each of the Ports (Ready or Not Ready), and the current window (numbers 1 to 6 or Message).

The Graphics mode Status Line displays the following information:

List 1\* Off Zoom 1/16\* 512K Source (xxxx,yyyy) Dest. (xxxx,yyyy,xxxx,yyyy)

This data gives the Display List number being used (the \* appears if the List number is not the same as the display factors number), whether Data logging is On/Off for the current Display List, the X zoom factor (the \* appears if the Y zoom factor is different than the X zoom factor), the Display List memory present on this terminal model, and the last two fields give the coordinates of the Source origin (in 0 - 1023 range) and the Destination rectangle (origin X,Y 0 - 1023; delta X,Y 1 - 1023 and 1 - 796). These items and the concepts on which they are based are discussed in detail in Chapters 8 and 9 on graphics operations.

Certain escape sequence commands can position the Status Line at different locations on the screen, or substitute the Message Line for the Status Line. These commands are discussed in the *HDS3200 Programmer's Reference Manual*.



## Chapter 3

# Setting Up Communications With The Computer

*SUMMARY Setting Up Communications With The Computer*

*This chapter describes the physical connections and the handshaking protocols needed to connect the terminal with other devices. Lists and tables, as well as accompanying definitions, are included for each communication port and protocol option. Instructions for choosing and saving the configuration from Setup Mode are included.*

### Some Suggestions on Procedure

Connecting a terminal to a computer or printer can be a simple or a difficult experience. It helps to have some knowledgeable assistance. This chapter contains all the necessary information for connecting to and communicating with the terminal. It is equally important to have all the same kinds of information about the computer or the printer, so you should have the other device's manual, or a person familiar with the device, close at hand. Refer also to **Appendix C** of this manual for suggestions on setting up several common printers. The **Glossary** may also be useful in helping you understand some unfamiliar terms.

There are two parts of the communications problem: first you must have a good physical connection with the computer or printer, that is, the appropriate wires to carry signals of one kind or another must be connected to each other. Since the terminal's requirements are not at all unusual, standard cables are usually sufficient to meet this need.

The second concern is the protocols used in communicating. A communications protocol is an agreement between the terminal and the other device about the form of the communication and how to start and stop. One device says, "Stop sending data for a moment", then, "OK, resume sending data." These signals are called protocol, or handshaking signals. The signals can be either hardware (signals on the CTS Line in the cable), or software (sending XON/XOFF characters on the data lines).

The protocols also involve choices about the form of the data, such as the speed of transmission, character identification, verifying procedures, etc. Choosing the correct protocol involves questions about the computer's operation and the way you use the terminal. This chapter makes suggestions about some protocols, but they are only suggestions and may not apply in your situation. An experienced user can be helpful in understanding vocabulary and in choosing the correct settings for the communications protocol.

### Making the Cable Connection

Always turn Off the terminal before you attach the cables. The standard connection for a terminal and a computer is the RS-232 connector. If you have a standard RS-232 cable, you can physically plug it into the terminal, and secure the cable with the fastening screws, but you must check that the individual

## HDS3200 Owner's Manual

lines in the cable are connected properly between the devices before you can go on and set the communications protocol.

The terminal has two (optionally three) communications ports. They are all 25-pin RS-232 connections; ports 1 and 3 are male connectors, port 2 is a female connector. You must use fully shielded cables when connecting to the terminal to comply with the FCC guidelines for RF emissions.

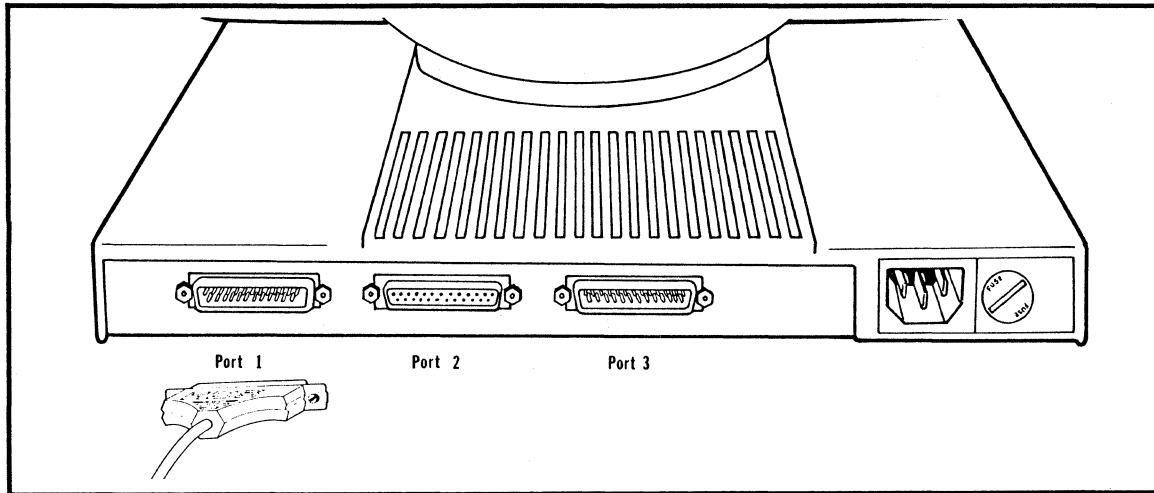

### HDS3200 Back Panel

The following table lists the RS-232 pin assignments for each of the three ports. These are the terminal lines needed for the connection, along with the function for each line. Verify that the other device uses the same lines for the same functions. If, for instance, the printer expects to see CTS (Clear To Send) signals on a pin other than 4 (for port 2), you must construct a cable that connects the two CTS pins together. Make sure that each of these signals is connected by the same line at both the terminal and other device.

The phrases used to describe the signals are sometimes slightly different, but this table should have sufficient information to identify the corresponding connections.

**Protective Ground** -- This pin is a ground for the cable.

**Transmitted Data** -- This pin transmits data from the terminal to the other device.

**Received Data** -- This pin receives data from the other device to the terminal.

**Request to Send** -- The RTS signal is held On by the terminal. It is turned Off on all Ports by the *Shift Break* key.

**Clear to Send** -- The CTS signal is sent by the other device as permission to send data from the terminal. The CTS signal is a protocol which must be specifically activated with a terminal command in Setup Mode. The terminal's default setting for communications protocol is XON/XOFF, another type of protocol.

**Signal Ground** -- This ground is used to establish a reference value for the data lines.

**Data Terminal Ready** -- The terminal generates this signal to indicate that the terminal is turned On. This signal is turned Off for all Ports with the *Shift Break* key.

**Data Set Ready and Carrier Detect** -- These signals are connected together internally and indicate that the terminal is turned On.

# HDS3200 Owner's Manual

## Communications Port Pin Assignments

	PIN NUMBER	DESCRIPTION	DIRECTION FROM TERMINAL
PORT 1 (male)	1	Protective Ground	- -
	2	Transmitted Data	Data out
	3	Received Data	Data in
	4	Request to Send (RTS)	Signal out
	5	Clear to Send (CTS)	Signal in
	7	Signal Ground	- -
PORT 2 (female)	20	Data Terminal Ready (DTR)	Signal out
	1	Protective Ground	- -
	2	Received Data	Data in
	3	Transmitted Data	Data out
	4	Clear to Send (CTS)	Signal in
	5	Request to Send (RTS)	Signal out
PORT 3 (male)	6	Data Set Ready (DSR)	Signal out
	7	Signal Ground	- -
	8	Carrier Detect (CD)	Signal out
	1	Protective Ground	- -
	2	Transmitted Data	Data out
	3	Received Data	Data in
	4	Request to Send (RTS)	Signal out
	5	Clear to Send (CTS)	Signal in
	7	Signal Ground	- -
	20	Data Terminal Ready (DTR)	Signal out

## RS-232 Connector Pin Assignments

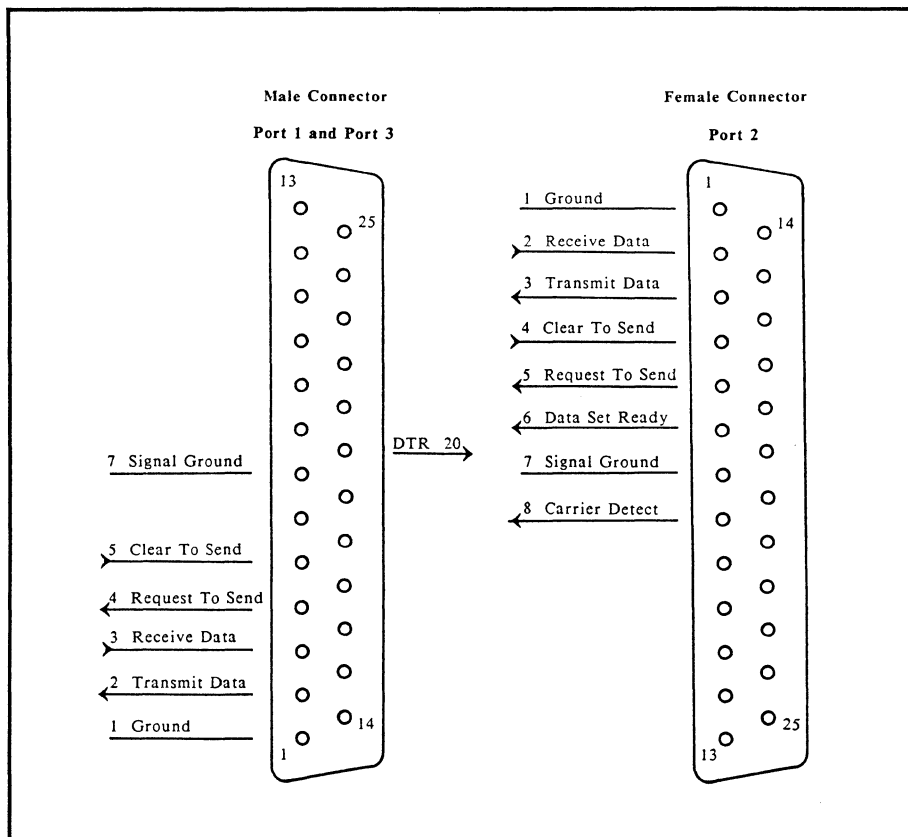

## Setting The Communications Protocol

Once the physical connection is made between the terminal and the device, the conventions of communication have to be set. These conventions depend principally on the capability of the computer or printer, since the terminal accepts almost all settings. The settings are made in Setup Mode, and can be saved in NVM (Non Volatile Memory). Again, you need to consult your computer or printer manual for the appropriate settings, or get a person familiar with the device to help make the choices.

The following list describes some of the choices you need to make. The descriptions and definitions are intended to give you an idea of what the settings mean, but these choices have to be considered together with the needs of the operating environment.

\* **Local Echo** This refers to the procedure used to display the characters on the screen. In Local Echo Mode (sometimes called Half Duplex Mode operation) the characters go from the keyboard both to the computer and to the screen. With No Local Echo, the characters go to the computer which in turn sends them back to the screen (called host echo or Full Duplex Mode operation). This choice depends on the computer or the device you're using.

\* **Baud Rate** The baud rate is the speed of communication, given in bits per second. Each device has a group of baud rates it can use. The terminal can communicate at 75, 110, 150, 300, 600, 1200, 2400, 4800, 9600, 19,200, or 38,400 baud. Compare this list with a similar list of baud rates for your other device, and choose the same setting for both devices. Generally, the capability of the device determines the baud rate you use on the terminal. For instance, if you are connected to the computer through a modem, the modem's capability determines the baud rate for the terminal.

There are two baud rate settings needed for the terminal, one for data transmitted and one for data received. Normally these rates are the same. The Setup Mode option =*Transmit* on the Receive Speed selection line chooses the same baud rate for transmitting and receiving. It is convenient to use the =*Transmit* setting because any change made to the Transmit baud rate is automatically made to the Receive baud rate.

\* **Limit Transmit Rate** The terminal can restrict the number of characters transmitted, regardless of the baud rates set, by waiting after each character is sent. The effective transmit rate in this arrangement is approximately 150-180 characters/second. This requirement is for communications devices that cannot handle a full speed transmission of data, for instance from a User Defined Key.

\* **Parity** Parity is a verification procedure that insures that each character is transmitted correctly. There are several different choices for parity: Even, Odd, Mark, Space, or No Parity. The Data/Parity selection line determines whether a parity bit is sent with data transmitted by the terminal.

The Parity Checking of Input selection line determines whether the terminal performs a parity check on data it receives. If Parity Checking of Input is set On, the terminal checks for the type of parity specified in the Data/Parity selection.

## HDS3200 Owner's Manual

Generally, all you have to know about parity is whether it is used or not, and whether the settings on the two communicating devices are the same.

Some computer systems require a parity bit as a "place-holder" but don't check the type of parity bit. This is called "Any parity". Note that in this case the No Parity setting will not work and that 7 data bits with any parity is not equivalent to 8 data bits with no parity. 7/Space parity is suggested.

**\* Character Size** A transmitted character is made up of a number of data bits, either 7 or 8. Devices that use 8 data bit character transmissions generally don't use a parity bit. Be sure that both devices are set to expect the same number of bits for each character.

The Terminal Mode setting to operate in VT220, 7-bit or 8-bit mode (chosen from the General Setup Menu) governs the manner in which 8-bit control codes are transmitted by the terminal, whether as 8-bit codes, or as their 7-bit equivalents. The Data/Parity character size selection specifies the number of communications bits sent for displayable characters going to or from the terminal.

**\* Stop Bits** Each character sent is separated by a marker called a stop bit, and either one or two stop bits may be sent. Generally two stop bits are used for baud rates of 300 or slower, and one stop bit for higher rates of transmission.

**\* Communications Protocol** This is the agreement between the terminal and the other device on starting and stopping transmission of data. The protocol is a way of saying, "Stop sending data" and "Resume sending data". There are two common protocols used, XON/XOFF (the terminal's default protocol), and CTS protocol. The terminal can use either one, so the requirements of the other device make the choice for you.

**\* XON/XOFF (Buffer Overflow Control) Protocol** uses a simple **Ctrl S** in the data stream to stop the transmission of data and a **Ctrl Q** to resume transmission. These characters are called XOFF and XON, respectively, and their use should be reserved for this protocol. The XON/XOFF protocol must be used for the 38,400 baud rate.

The XON/XOFF Control line has options to set when the XOFF character is sent in the process of filling the terminal's input buffer, either when there are 64 or 128 unread characters in the buffer. XOFF is also sent again when the buffer is full.

The important thing to realize about this protocol is that whenever an XOFF is sent, an XON must follow or the device will appear to "hang", when it is just waiting for an XON. This applies in both the sending and receiving directions. If the terminal is hung in this way, it can be cleared with the Clear Communications Ports command on the General Setup Menu. The XON/XOFF protocol operates on the terminal in both the sending and receiving directions.

The XON/XOFF protocol is used by the terminal for control of the special local keyboard operating modes, such as Setup Mode, Calculator Mode, and Zoom and Pan Definition Modes. In these operating modes the terminal temporarily suspends communication with the host by using the XON/XOFF protocol. If the protocol is working correctly, the host and the application programs are unaffected by this



suspension of activity and no characters are lost.

\* **CTS (Transmit) Protocol** uses a separate signal (high or low voltage) on the assigned line to tell the terminal whether it is clear to send or not. The CTS protocol can be set for the host to control data transmission from the terminal.

### Default Communications Settings

The terminal is configured with the following factory settings:

Selection	Port 1	Port 2	Port 3 (Mouse Input)
Operating Mode (all ports)	VT220, 7-bit	VT220, 7-bit	VT220, 7-bit
Baud rate (=Transmit)	9600	9600	2400
Protocol	XOFF at 64	XOFF at 64	XOFF at 64
CTS Needed For Transmit	No	Yes	No
Data/Parity	8/None	8/None	8/Odd
Parity Checking of Input	No	No	No
Stop bits	1	1	2
Local Echo	No	No	No
Limit Transmit Rate	Yes	No	Yes

### Making The Settings In Setup Mode

All communications settings can be made in Setup Mode. Enter Setup Mode by pressing the *Setup* key. Then select the Communications Menu. The first line of the Menu selects the Port and there is a separate Communications Setup Menu for each port. Each port device can have a different communications configuration. A status line appears at the bottom of the Setup Menu which shows the current status of each Port, either Ready or Not Ready. The Port currently selected as the Host Port is shown with a bold display. The last field gives the currently selected window.

The port uses the communications settings which are in place when you exit Setup Mode. Those settings remain in effect until they are changed, the terminal is turned Off, or the "Recall Settings from NVM" field is executed. You can save the selections in permanent memory so they will be used automatically when the terminal is turned On by executing the "Save Settings into NVM" field on the General Setup Mode Menu.

\* The first field is the **Port Number**, with options 1, 2, or 3. (Port 3 appears as an option only if the terminal has Port 3 installed.) The Status Line shows which Port is currently the Host Port in bold display.

The Setup Menus for Ports 1 and 3 are similar; the Menu for Port 2 has four additional fields to select printer options. On graphics terminals there are two additional fields on the Port 3 Menu for mouse and digitizer tablet operations. Note that Port 3 is set to receive Mouse input as a factory setting, with the other communications settings preset as required by the mouse. The following illustration shows the Port 2 Communications Setup Menu.

## HDS3200 Owner's Manual

HDS3200-30 Setup Mode - Version 0.0

To Choose	Use
. Setup menus	. Editing keys, Do, Help
. Next fields	. Up or down arrow keys
. Next values	. Left or right arrow keys

Graphics	HDS Extensions	
General	User Prefer.	Communi- cation
User Defn Key	Keyboard	Next Menu

```

> Port Number.....2.....>
  Transmit Speed          9600
  Receive Speed           =Transmit
  XON/XOFF Control       XOFF at 64
  Clear to Send Needed for Transmit Yes
  Data/Parity            8/None
  Parity Checking of Input No
  Stop Bits              1
  Local Echo             No
  Limit Transmit Rate    No
  Printer Mode           Normal
  Printing Extent        Entire Page
  Print Terminator       None
  Printed Data Type      National
Options: 1; 2; 3
Replace      Ready          Ready          Ready          1
    
```

\* **Transmit Speed and Receive Speed** These fields set the baud rate, the first for transmitted data, the second for received data. The Receive Speed field has an option =Transmit which sets the receiving speed equal to the transmitting speed. This is almost always the recommended setting. Choose the Transmit Speed you want (options are: 75, 110, 150, 300, 600, 1200, 2400, 4800, 9600, 19200, and 38,400; the factory setting is 9600) and set the Receive Speed to =Transmit. If the Receive Speed is set =Transmit, changing the Transmit speed automatically changes the Receive speed.

\* **XON/XOFF Control** This field selects the XON/XOFF protocol for both the Send and Receive directions. It also sets the point at which the XOFF is sent for data entering the terminal's input buffer. The options are No XOFF (the protocol is not used); an XOFF character is sent when the buffer has 64 unread characters; and an XOFF character is sent when the buffer has 128 unread characters. Additional XOFF characters are sent when the buffer is almost full and when totally full. All three terminal ports have input buffers of 256 characters.

\* **CTS Needed For Transmit** The Clear To Send (CTS) protocol is set On for Port 2 (usually the printer) and Off for Ports 1 and 3. This protocol uses the CTS Line (pin 4 of Port 2) to govern the transmission of data. Options are Yes and No for Ports 1 and 3, but there is an additional choice for Port 2, the SPI option which is described below.

For the Port 2, frequently used with printers which use the CTS/RTS protocol, there are two types of "Yes" response to the CTS Needed option: Yes means that the terminal follows the DEC VT220 format and requires CTS to be high to permit transmission to occur, but there is no raising or lowering of RTS to request the device and no means to abort the communication. The second Yes response is labeled SPI (for use with HDS Shared Printer Interface devices), in which RTS will be toggled and CTS will be used in response to device inquiry about availability, or with the Printer Status command.

\* **Data/Parity** This field selects the number of data bits used in each character (either 7 or 8) and the parity type used with data transmitted by the terminal. The None option indicates that no parity bit is sent by the terminal. With 7 data bits, there are four parity selections: Even, Odd, Mark, and Space. With 8 data bits, there are two parity selections: Even and Odd.

The Port 1 factory setting for the Data/Parity selection is 8/None, which operates correctly in Terminal Mode DEC VT220, 7-bit (from the General Setup Menu). You may notice some multinational characters appearing on the screen or some commands incorrectly interpreted, such as Ctrl M executing Esc M. This results from errors in interpreting 7 and 8 bit characters.

If you are using a graphics application program, particularly one which is based on Tektronix compatible commands, you should choose DEC VT220, 7-bit Terminal Mode and 7 data bit communication since Tektronix commands don't support 8 bit configurations.

\* **Parity Checking of Input** This field determines whether the terminal performs a parity check on data it receives. If the Yes option is selected, input data is analyzed for the type of parity selected by the Data/Parity setting. A character received with a parity error is displayed by the terminal as a reverse question mark.

\* **Stop Bits** The next field selects the number of stop bits used, either 1 or 2.

\* **Local Echo** This field selects the procedure used to display the characters on the screen. In Local Echo Mode (sometimes called Half Duplex Mode operation) the characters go from the keyboard both to the computer and to the screen. With No Local Echo, the characters go to the computer which in turn sends them back to the screen (called host echo or Full Duplex Mode operation).

\* **Limit Transmit Rate** This field allows you to select a state in which the terminal restricts the rate of the characters transmitted, regardless of the baud rates set, by waiting after each character sent. The effective transmit rate is approximately 150-180 characters/second. This requirement is for communications devices that cannot handle a full speed transmission of data, for instance from a User Defined Key, which sends its contents as a block at the baud rate speed.

The factory setting of this field is Yes for Ports 1 and 3, and No for Port 2.

### **Printer Settings**

The following Communications Menu fields apply only to Port 2, usually connecting to a printer. Refer also to **Appendix C** of this manual for suggestions on connections for several common printers. A field to select a printer buffer is available on the Graphics Setup Menu for terminals with graphics display list memory.

## HDS3200 Owner's Manual

\* **Printer Mode** This field selects the type of printing command issued by the terminal. The Normal option is for normal printing, with individual print commands (such as the *Print Scrn* key command) given when Port 2 is connected. The Auto-Print option automatically prints the current cursor line each time a Line Feed character is received. The Printer Controller option connects Port 2 to the terminal network for all data, so everything received from the host computer (including command characters and control codes, except Ctrl S and Ctrl Q) is sent to the printer.

\* **Printing Extent** This field selects the extent of the data from the terminal which is sent to the printer, either the entire window or the currently defined scrolling region. A scrolling region may be defined, by separate terminal command, to be less than the whole window. The factory setting has the scrolling region equal to the whole window.

\* **Print Terminator** This field selects the character sent at the end of data after a Print Screen command is executed. The options are None (No character sent) or Form Feed. Some applications require a Form Feed character at the end of transmissions to advance the paper; other applications supply the character themselves.

\* **Printed Data Type** This field allows you to select the type of characters that are sent by the terminal to the printer, and depends chiefly on the capability of the printer. The National Only option means that the terminal sends only ASCII characters (command sequences to change character set or attributes are ignored). The National and Line Drawing option means that ASCII and Graphics characters are sent to the printer along with commands to switch the printer into G0 and G1 character sets. Changes in character attributes (or graphic rendition) are sent to the printer as escape sequences and characters from the International character set are printed as equivalent ASCII characters. The Multinational option means that ASCII, graphics, and International characters are sent, with the command sequences to select them, to the printer. The All Characters option means that all character sets, ASCII, Special Graphics, Multinational, and DEC Technical, are sent. Changes in character attributes are sent as escape sequences.

### Printed Data Type Setup Mode Selections

Setup Option	Character Sets Transmitted				Character Attributes
	ASCII	Special	Grap.	Multinational	
National Only	X				None sent
Line Drawing	X	X			X
Multinational	X	X		X	X
All Characters	X	X		X	X

Port 3 Mouse And Digitizer Tablet Selections

HDS3200-30 Setup Mode - Version 0.0

To Choose      Use  
 . Setup menus . Editing keys,Do,Help  
 . Next fields . Up or down arrow keys  
 . Next values . Left or right arrow keys

Graphics	HDS Extensions	
General	User Prefer.	Communi- cation
User Defn Key	Keyboard	Next Menu

```
> Port Number.....3.....>
Port 3 Input from      Mouse
Mouse Active          Graphics
Transmit Speed        2400
Receive Speed         -Transmit
XON/XOFF Control      XOFF at 64
Clear to Send Needed for Transmit No
Data/Parity           8/Odd
Parity Checking of Input No
Stop Bits             2
Local Echo            No
Limit Transmit Rate   Yes
```

```
Options: 1; 2; 3
Replace      Ready          Ready          Ready          1
```

HDS3200 Series terminals can accept mouse input for either general cursor movement in ANSI text mode operation, cursor movement in GIN mode of graphics operation, or special movements and key assignments in Setup Mode and Zoom and Pan Definition Modes. The Port 3 Input field and the Mouse Active field on the Port 3 Communications Setup Menu select this configuration.

\* **Port 3 Input From** This field designates what kind of device is connected to Port 3. The options are: Mouse input (the factory setting), four selections for digitizer tablets (MM Series and Bit Pad One by Summagraphics), and Normal (RS232), which designates a normal Port 3 connection and communication.

The Mouse and digitizer tablet options instruct the terminal to interpret the data from the mouse or digitizer as cursor movements on the screen. The Normal (RS232) option is for intelligent device communication to Port 3 and requires the host software to interpret the data communicated to the Port.

The digitizer options are for Summagraphics models MM1201 (full pad) in which the entire pad height corresponds to the 780 pixel height of the screen, MM1201 (partial pad) in which the 1024 x 780 screen dimension is mapped exactly onto the pad (leaving the upper part of the pad unused), MM1812/961 pads, or Bit Pad One digitizer tablets.

For normal (RS-232) Port 3 operation, you must set the baud rate and other communications settings for Port 3 as needed. For the Mouse and Digitizer options, these settings are selected automatically and will change any Port 3 configuration already set. The user should not change the settings for the mouse or the digitizer.

\* **Mouse Active** This field selects when the mouse is active. The options are: Graphics, and Graphics and ANSI. When Graphics is selected, mouse activity is

interpreted when the terminal is in Graphics mode and Setup mode. When Graphics and ANSI is selected, mouse activity is registered all the time, in ANSI text mode for cursor movement, in Setup mode, and in Graphics mode.

### Some Troubleshooting Suggestions

Most of the time, the terminal and the computer work well together as soon as they are hooked up. Occasionally, however, some problem arises that tries your patience and your skill. The first thing to do is make sure the problem is one of communication. If the problem is limited to a single piece of software, the software is probably at fault. If the problem is limited to a single device, one printer, or one modem Line, the problem is probably there.

If you're losing some characters between the two devices, or the characters are somehow garbled, or the terminal hangs when you try to attach or detach the device, the problem is most likely in the communication settings.

If the terminal hangs, that is, doesn't respond to commands, especially when you've just used another device, it may mean that the communications protocol isn't working correctly. The computer may have received the data but did not acknowledge receiving it by sending an XON to the terminal to resume transmission. The terminal isn't hung, it's simply waiting for a protocol signal that will allow it to resume.

If the characters you transmit are all received but are somehow mixed up (often including control characters that don't print, or completely different symbols), the problem may be in the selection of the number of data bits and parity settings. If this selection is wrong, the device may interpret a character bit or parity bit incorrectly and assign the wrong character to that sequence of transmitted bits. Make sure the settings are the same on the terminal and the other device or try other settings. This condition may also be caused by mismatched baud rates. If one device is faster than another, it may interpret parity bits or stop bits as parts of characters. Observing several received characters when only one character is sent is caused by this kind of problem.

If all the characters aren't transmitted, the problem may be either the protocol or the baud rate. When you enter data normally from the keyboard, character transmission is very slow (at least relative to the computer's ability to read and interpret it) whether the baud rate is set to be low or high. For instance, at a low speed of 300 baud, the transmission is about 30 characters a second, so the buffers that temporarily store the characters you type should never overflow and lose data, and so the protocol may appear to operate correctly. However, if you are transferring a large number of characters (either by using a User Defined Key, or with some editing command) at high baud rates, the protocol may not work correctly and drop characters, even though the protocol and baud rate appeared to work correctly in other slower situations. Verify the operation of the protocol or try using a lower baud rate.

There are other techniques to test communications, but they can be tricky because their implications are very far reaching. These techniques are best left to sophisticated users who understand the consequences of these changes.

### Optional 20 ma Current Loop Interface

Some communications situations require a different type of interface called a current loop. This option is available with a factory modification for HDS3200 Series terminals.

The current loop option is available on Port 1 only. It is a passive (the other device must always be the active device) 20 ma current loop which uses the following pins on the RS-232 connector of Port 1:

Terminal Transmit	Pin 18 (+)
	Pin 25 (-)
Terminal Receive	Pin 10 (+)
	Pin 11 (-)

A jumper on the main electronics board selects the 20 ma current loop option or the RS-232 interface. Consult the *HDS3200 Service Manual* for details.

### Optional RS-423 Interface

The RS-423 interface is a factory installed option which allows transmission of data over greater distances than the standard RS-232 interface. The RS-423 interface uses the same pin configuration as the RS-232 interface (refer to the charts earlier in this chapter for pin assignments) but with greater signal control and levels. The RS-423 interface applies to all ports if it is installed.

Chapter 4

User Defined Function Keys

*SUMMARY User Defined Function Keys*

The HDS3200 terminal has three sets of 21 programmable function keys that, shifted and unshifted, can accept 126 definitions by the user to send any key sequence or command. All these keys receive their definitions from the user by means of Setup Mode, with a simple menu and definition procedure. Three separate sets of key definitions can be entered and techniques for using this feature from Setup Mode are discussed. A chart is included which lists all the User Defined Keys and their factory settings. This chapter also describes programming the keys on the mouse and digitizer tablet.

Programmable Keys

All of the keys shown on the following keyboard illustration can be given user definitions.

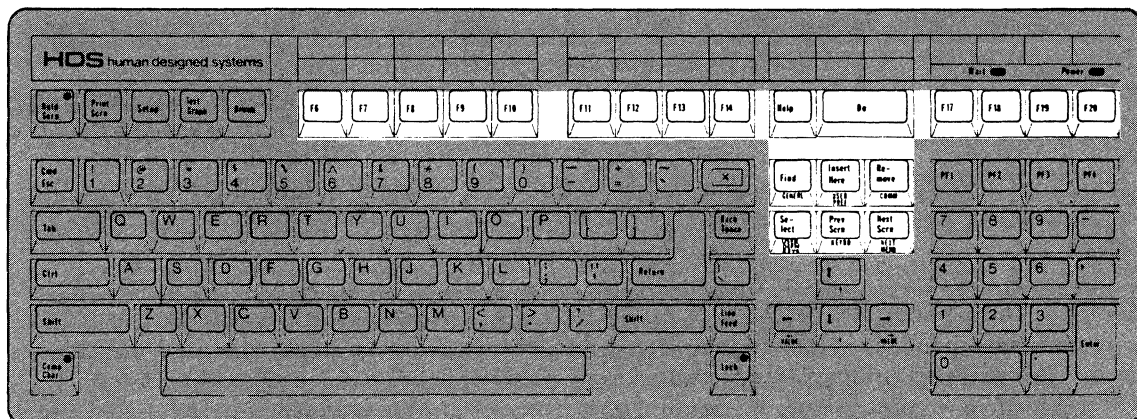

In their factory set definitions, the unshifted versions of these keys have only an identifying sequence as a definition. Application programs may give them other functional definitions. The terminal can store up to three sets of definitions for the shifted and unshifted keys at the same time and switch between the sets by means of Setup Mode or remote command.

Some keys, like Return, can be set to different assignments, such as CR/LF, by specific commands (the New Line option) in Setup Mode. Other keys can have their function disabled in Setup Mode. Refer to the Keyboard Menu in Setup Mode.

For graphics terminals that use a mouse or digitizer tablet, the buttons on the mouse and the digitizer tablet are also programmable as function keys. They have been given useful operating definitions as factory assignments in graphics and GIN mode operation.



### Defining Keys From Setup Mode

The procedure to define keys is a simple one. Enter Setup Mode by pressing the Setup key. Press the User Defn Keys key in the cursor keypad to get the "User Defined Keys" Menu. This is the entry point to the programming procedure.

The User Defined Keys Menu offers seven selections, the first two to program keys, the next one to select whether user defined keys can be locked against redefinition from the host computer, and the next two to reset the user definitions to the factory settings. Finally, Setup Mode offers two fields to select whether the terminal uses one set of function key definitions or three sets, and then if the three set option is selected which of the three sets to use. These four groups of function key options will be discussed in turn.

### Programming User Defined Keys

There are two selections for programming a User Defined Key. They are exactly the same except for the way the definition is stored by the terminal. The first option is for Permanent definitions that are stored in Non Volatile Memory (NVM) so they are available after power Off or Recall Settings from NVM situations. The second option is for Temporary definitions that are stored in RAM memory and are lost when the terminal is turned Off or Recall Settings from NVM is executed.

If both NVM and RAM definitions are given to the same User Defined Key, the RAM definition takes precedence. Generally, RAM definitions are used by application programs and are held in memory while the program is in use but erased when the terminal is reset. NVM definitions are generally entered by the user for more permanent use for such entries as login sequences, modem commands, networking configuration commands, etc.

To enter a definition select one of the Program UDK lines, either for RAM or NVM memory, then press either the left arrow or right arrow keys to begin the programming process. The bold video line prompts you to press the key you want to define, shifted or unshifted. When you press the key, the key label and its shifted state appear on the Program UDK line to confirm your choice, the prompt line shows additional instructions for entering the definitions, and a reverse video block appears for entering the definition. If you choose to enter definitions for one of the Editing Pad keys, it will be treated as any other User Defined Key except when the terminal is in Setup Mode operation, when it will use its Setup Mode definition.

A definition previously entered for that key appears in the highlighted block with the cursor at the end of the definition. You can delete the previous definition with the left arrow key.

You can enter your new definition at this point. Just type the keys you want, either for text or commands. The characters appear in the reverse video block as you type them. Even characters not usually displayed, such as CR and LF, or sequences from Numeric Pad keys, appear. This display mode is called Transparent Mode and is used so you can see all the characters in your commands. You can make corrections to your definitions by pressing the left arrow key and erasing the previously typed character.

When the key's definition is complete, press the right arrow to save the definition and return to the Setup Mode User Defined Key Menu. Pressing the up arrow or down arrow keys will return you to the Setup Mode User Defined Key Menu without storing the definition.

### Special Characters In Key Definitions

Special characters can be used in User Defined Key definitions and are displayed in the Setup Mode definition block with their special symbols or as hexadecimal numbers representing 8 bit control codes. For instance, the Cmd key appears on the screen as CMD, Return appears as CR, and so on.

Multinational characters can be used in definitions and generated by the Comp Char key. Refer to **Appendix A** for details on using the Comp Char key. The Comp Char key can also be used to generate 8 bit control code characters in the definitions. An 8 bit control code has an equivalent 7 bit escape sequence (refer to the *HDS3200 Programmer's Reference Manual* for details). An 8 bit control code is generated by using the Comp Char key and entering the 7 bit escape sequence in the definition. The 8 bit control code is displayed as its hexadecimal chart location. For example, CSI (ESC [ in 7 bit form) is hexadecimal 9B, DCS (ESC P in 7 bit form) is hexadecimal 90, etc.

Pressing a User Defined Key while programming another key enters the definition of the first key into the definition of the second. This copies one key onto the other. Try pressing one of the function keys to see how their definitions appear on the screen. The cursor pad arrow keys' definitions can be entered (for cursor movement commands) in User Defined Key definitions by using the Ctrl Shift arrow key.

A User Defined Key should not be programmed to execute commands to define or execute any other User Defined Key.

### Mouse And Digitizer Key Programming

The three buttons on the mouse and the four buttons on the digitizer are programmable. Their definitions are available either in ANSI or graphics mode operation, can be selected as either RAM or NVM definitions, and can be programmed either from Setup Mode or by the HDS UDK terminal command.

The mouse has three buttons and each has two key numbers, one for the Up and one for the Down position. In Setup Mode the Up position of the mouse key is programmed by pressing the Comp Char key and then the mouse key. The Down position is programmed by pressing the key alone. The digitizer tablet buttons are programmable with only one definition each.

The mouse can be used for general cursor movement in text operation. It can be used in Setup Mode, where its buttons select setup menus and options. In graphics operation, the mouse can be used in Zoom and Pan Definition Mode, where its buttons have factory definitions to enter and exit Zoom and Pan modes or Draw the screen.

In GIN mode of graphics the mouse buttons have other factory definitions. In the factory setting, the mouse tracking ratio is set as 1:1 (mouse:screen). The mouse buttons operate to change this ratio, with the Down definition being set to change the tracking ratio by a factor of 1/2 (so the new ratio is 1:2), and the Up definition is set to change the definition by a factor of 2 (so the new ratio is back to 1:1). The definitions operate when the button makes the transition from Up to Down or Down to Up. You therefore use the buttons by pressing a button down (the Down definition because of the Down transition), hold it down as long as you want that definition, and release it when you want the Up definition (which is selected on the upward transition of the button). The definition (tracking ratio) changes whenever the button changes, either on the downstroke or on the upstroke.

### **Storage Limitations for User Defined Keys**

You can enter up to 255 characters for a single key definition. That is the marked size of the reverse video definition block. The total storage capacity for all definitions is approximately 1400 characters, for both RAM and NVM definitions combined. The reverse video block shows only the available amount of storage. If you attempt to enter more than 255 characters for one definition or the number of characters available is exceeded, the Bell rings and the excess characters are ignored.

### **Locking User Defined Key Programming**

The next Setup Mode field, User Defined Key Programming, offers the option of permitting the User Defined Keys to be programmed from the host computer (the Unlocked setting), or not. If the keys are locked, their definitions cannot be changed, or the locked state altered, except from the keyboard of the terminal.

### **Reset Definitions To Factory Defaults**

The next two menu fields offer the option of returning the RAM (temporary) definitions or all definitions, including both the NVM and RAM (permanent and temporary) definitions, to their factory settings for all User Defined Keys.

### **Three Function Key Sets**

The HDS3200 terminal has the capability of storing three sets of definitions for User Defined Keys at the same time. This capability is especially useful for networking and multiple computer applications. Refer to Chapter 10, *Multiple Computer Applications* for some examples.

The Setup Mode fields first allow you to select whether the terminal uses one set of definitions or three sets, with the options 1 or 3. The last field on the Setup Menu selects which of the three sets of definitions will be used when you are in three-set mode, with the options 1, 2, or 3.

The total amount of storage space available for User Defined Keys is about 1400 characters. This space is shared by all three sets of definitions. The definitions stored in sets 2 and 3 are maintained until they are explicitly erased, even if you go back to one-set mode.

## User Defined Keys Keychart

This chart shows the keys and the factory settings of the HDS3200 User Defined Keys. The factory definitions are simply identification sequences for each key which have no direct application. CSI designates an 8 bit control code; its 7 bit equivalent is ESC [.

### Unshifted Keys

Key Label	VT220 Default	VT100/VT52 Default or Graphics
Find	Send <i>CSI 1</i> ~	Do Nothing
Insert Here	Send <i>CSI 2</i> ~	Do Nothing
Remove	Send <i>CSI 3</i> ~	Do Nothing
Select	Send <i>CSI 4</i> ~	Do Nothing
Prev Scrn	Send <i>CSI 5</i> ~	Do Nothing
Next Scrn	Send <i>CSI 6</i> ~	Do Nothing in graphics Clear screen, enter Alpha mode
F6	Send <i>CSI 17</i> ~	Do Nothing
F7	Send <i>CSI 18</i> ~	Do Nothing
F8	Send <i>CSI 19</i> ~	Do Nothing
F9	Send <i>CSI 20</i> ~	Do Nothing
F10	Send <i>CSI 21</i> ~	Do Nothing
F11	Send <i>CSI 23</i> ~	<i>Escape</i>
F12	Send <i>CSI 24</i> ~	<i>Backspace</i>
F13	Send <i>CSI 25</i> ~	<i>Line Feed</i>
F14	Send <i>CSI 26</i> ~	Do Nothing
Help	Send <i>CSI 28</i> ~	Do Nothing
Do	Send <i>CSI 29</i> ~	Do Nothing
F17	Send <i>CSI 31</i> ~	Do Nothing
F18	Send <i>CSI 32</i> ~	Do Nothing
F19	Send <i>CSI 33</i> ~	Do Nothing
F20	Send <i>CSI 34</i> ~	Do Nothing

Shifted Keys

---

Key Label	VT220 Default	VT100/VT52 Default or Graphics
Find	Do Nothing	Do Nothing
Insert Here	Do Nothing	Do Nothing
Remove	Do Nothing	Do Nothing
Select	Do Nothing	Do Nothing
Prev Scrn	Do Nothing	Do Nothing
Next Scrn	Do Nothing	Do Nothing in graphics Clear screen, enter Alpha mode
F6	Do Nothing	Do Nothing
F7	Do Nothing	Do Nothing
F8	Do Nothing	Do Nothing
F9	Do Nothing	Do Nothing
F10	Do Nothing	Do Nothing
F11	Do Nothing	<i>Escape</i>
F12	Do Nothing	<i>Backspace</i>
F13	Do Nothing	<i>Line Feed</i>
F14	Do Nothing	Do Nothing
Help	Do Nothing	Do Nothing
Do	Do Nothing	Do Nothing
F17	Do Nothing	Do Nothing
F18	Do Nothing	Do Nothing
F19	Do Nothing	Do Nothing
F20	Do Nothing	Do Nothing

---

**Mouse/Digitizer Keys**

The mouse and digitizer keys are programmable like any other keys. In Setup Mode the Up position is selected by pressing the *Comp Char* key, then the desired key. The Down position is selected by pressing the key alone. These keys are executed immediately by the terminal.

In GIN Mode of graphics the factory definitions for all three keys change the tracking ratio for the mouse, by a factor of 2 for the Up definition and a factor of 1/2 for the Down definition. The key activity is registered on the transition from Up to Down or vice versa, not the final state.

---

---

<b>Key</b>	<b>Key Action</b>
Mouse Button Up	1:1 Mouse:Screen
Mouse Button Down	1:2 Mouse:Screen

---

---

In normal graphics operation the mouse key definitions are to enter or exit Zoom, Pan, and Draw modes. The modes are selected by a normal keystroke, press and release.

---

---

<b>Key</b>	<b>Key Action</b>
Mouse Right	Enter/exit Pan Definition Mode
Mouse Middle	Execute Draw Function
Mouse Left	Enter/exit Zoom Definition Mode

---

---

In Setup Mode the mouse key definitions are as shown. For Tab editing in Setup Mode, the Left and Right keys toggle the tab setting and the Middle key exits the Tab editing field.

---

---

<b>Key</b>	<b>Key Action</b>
Mouse Right	Select Previous Field Option
Mouse Middle	Select Next Setup Menu
Mouse Left	Select Next Field Option

---

---

**Cursor/Numeric Pad**

The mode of operation of the Cursor and Numeric Keypads depends on the settings chosen in Setup Mode. The definitions in the chart shown for each operating mode are sent when the key is pressed. CSI is an 8 bit control code; its 7 bit equivalent is ESC [. SS3 is also an 8 bit control code; its 7 bit equivalent is ESC O (uppercase o, not zero).

**Cursor Pad Transmission**

---



---

Key	VT220/VT100 Mode		VT52 Mode	
	Normal Mode	Application Mode	Normal Mode	Application Mode
Up arrow	CSI A	SS3 A	ESC A	ESC A
Down arrow	CSI B	SS3 B	ESC B	ESC B
Right arrow	CSI C	SS3 C	ESC C	ESC C
Left arrow	CSI D	SS3 D	ESC D	ESC D

---



---

**Numeric Pad Transmission**

---



---

Key	VT220/VT100 Mode		VT52 Mode	
	Normal Mode	Application Mode	Normal Mode	Application Mode
0	0	SS3 p	0	ESC ? p
1	1	SS3 q	1	ESC ? q
2	2	SS3 r	2	ESC ? r
3	3	SS3 s	3	ESC ? s
4	4	SS3 t	4	ESC ? t
5	5	SS3 u	5	ESC ? u
6	6	SS3 v	6	ESC ? v
7	7	SS3 w	7	ESC ? w
8	8	SS3 x	8	ESC ? x
9	9	SS3 y	9	ESC ? y
Minus	-	SS3 m	-	ESC ? m
Comma	,	SS3 l	,	ESC ? l
Period	.	SS3 n	.	ESC ? n
Enter	CR	SS3 M	CR	ESC ? M
PF1	SS3 P	SS3 P	ESC P	ESC P
PF2	SS3 Q	SS3 Q	ESC Q	ESC Q
PF3	SS3 R	SS3 R	ESC R	ESC R
PF4	SS3 S	SS3 S	ESC S	ESC S

---



---

## Chapter 5

### Graphics Terminal Operation

#### *SUMMARY Graphics Terminal Operation*

*This chapter contains an overview of the graphics capabilities of the HDS3200 Series graphics terminals, Models 10, 20, and 30. Since the utilization of most graphics features of the terminal is done by the user's application programs, the information presented here is for entering and exiting graphics mode, setting up and using the mouse and digitizer tablet, configuring the terminal for printer support, and for graphics data transmission protocols.*

#### **HDS3200 Series Graphics Terminals**

All HDS3200 Series terminals have graphics capability in addition to their alphanumeric functions. The difference between the various models can be summarized as two factors: screen resolution of the monitors, and special functions related to graphics display list memory. The screen resolution is either medium resolution (1056 x 400 pixels) or high resolution (1056 x 800 pixels). The special functions are Zoom and Pan Definition Modes, Graphics Quadrants, Display List storage of graphics images, and a printer buffer.

Operation of a graphics terminal usually amounts to operating a graphics application program. Graphics terminal commands and addressing are sometimes complicated and cumbersome and are best handled by the program interface. As a consequence, most users of graphics terminals need to know relatively little about the terminal, just that it will work with some particular graphics application program.

HDS3200 Series graphics terminals emulate the Tektronix 4010 and 4014 terminals, graphics terminals in widespread use whose graphics techniques are a shared industry convention. Because Tektronix graphics commands do not support an 8 bit terminal configuration and many graphics application programs are designed to be Tektronix compatible, the terminal should be set for DEC VT220, 7-bit Terminal Mode (General Setup Menu) and 7 data bit communications (Communication Setup Menu). The terminal will specifically ignore the 8th bit in graphics mode operation.

This chapter discusses briefly the few selections in Setup Mode you need to configure the HDS3200 Series graphics terminals, but leaves discussion of graphics operation, graphics commands, screen addressing techniques, etc. for the Quick Reference Guide at the end of this manual and the *HDS3200 Programmer's Reference Manual*. If you need information of this type, refer to those manuals. Specific information about Zoom and Pan operations and other special graphics functions are contained in Chapter 8, *Graphics Zoom/Pan Operation* and Chapter 9, *Advanced Graphics Concepts* of this manual.

#### **HDS3200 Series Graphics Terminal Features**

The HDS3200 Series' large screen and high readability recommend it for any graphics work. Other features, such as the optional mouse and digitizer input, programmable buttons for the mouse and digitizer, Zoom and Pan modes, display list data logging, and the high degree of compatibility with other graphics



terminals, give the HDS3200 Series terminals outstanding performance among graphics terminals.

Remember that these graphics terminals are really two terminals, since each is a fully configured ANSI text terminal as well as a separate Graphics terminal. The Graphics side of the terminal includes its own commands, operations, and its own display memory. Many of the features you use, such as Setup Mode, character sets, and terminal commands are part of the ANSI side of the terminal and are applicable only when the terminal is in ANSI mode.

### The Text Graph Key

The Text Graph key is an easy way to enter and exit graphics mode operation. Pressing the Text Graph exits ANSI text mode and enters alpha mode of graphics operation. Pressing Shift Text Graph exits graphics operation and returns to text mode operation. Using Ctrl Text Graph exits ANSI text mode, enters alpha mode of graphics operation, and clears the graphics screen.

### The Next Scrn Key

When the terminal is in graphics mode operation, the Next Scrn key has a functional definition by factory assignment. Pressing Next Scrn clears the screen and enters Alpha mode of graphics from any other graphics mode. Pressing Next Scrn will not enter graphics from ANSI mode operation.

The Next Scrn key has a different definition when the terminal is in Zoom and Pan Definition Modes. Refer to Chapter 8 for details. It also can be used to clear the Graphics Alpha mode screen with the Page Full setting from the Graphics Setup Menu. You may also give the Next Scrn key another definition as with any other User Defined Key.

The Prev Scrn, Remove, and Insert Here keys also have special definitions related to Zoom and Pan operations. These are to execute the Times 1 function, exit Zoom or Pan Definition Mode, and start Data Logging respectively. These operations are described in detail in Chapter 8.

### Graphics Configuration In Setup Mode

The Graphics Menu in Setup Mode contains a number of settings necessary for you to operate the terminal in graphics mode.

The shaded area of the Setup Menu indicates optional features which may not be available on all HDS3200 models. The particular graphics features available on the model you have are shown on the Setup Menu on your terminal. Notice that the mouse and digitizer tablet selections appear on the Port 3 Communications Setup Menu.

\* **Clear Graphics Display** This field executes the command to clear the graphics memory. Text memory is unaffected.

\* **Graphics/Text Overlay** This field controls which display memory appears on the screen. The options include: Yes, which means that both graphics and text

## HDS3200 Owner's Manual

HDS3200-30 Setup Mode - Version 0.0

To Choose	Use
. Setup menus	. Editing keys, Do, Help
. Next fields	. Up or down arrow keys
. Next values	. Left or right arrow keys

Graphics	HDS Extensions	
General	User Prefer.	Communi- cation
User Defn Key	Keyboard	Next Menu

```

> Clear Graphics Display.....>
Graphics/Text Overlay          No
Graphics Resolution            Medium
Graphics Printer                LA75
Graphics GIN Mode Terminator   CR
Page Full                       Off
Select Graphics Page           1
Print Buffer                     No
Display List data logging      Yes
Graphics Quadrant Mode         No
Select Display List/Quadrant   1
  
```

Press left or right arrow to perform action

Replace            Ready            Ready            Ready            1

memory contents are shown on the screen simultaneously, or No, which means that only the memory of the operating mode currently selected (text or graphics) is displayed.

\* **Graphics Resolution** This field selects the screen resolution of the HDS3200 terminal, and depends on the terminal model you have. This field is available only on high resolution terminals. The options are: Medium, which selects 1056 x 400 pixel resolution; or High, which selects 1056 x 800 pixel resolution for the screen.

\* **Graphics Printer** This field controls how graphics data to be printed is formatted and sent out. The options select various printers which use particular graphics printing conventions. The choices of printer type include: LA75 (DEC), FX80 (Epson), C.Itoh, Anadex, Okidata, Thinkjet (HP), or Laserjet II (HP).

Refer also to **Appendix C** of this manual for additional suggestions and tables for setting up these printers for correct communication with the terminal.

\* **Graphics GIN Mode Terminator** This field selects the character or characters to be sent by the terminal after exiting GIN mode or after executing a status command. The options include: None, CR, CR/LF, or CR/EOT characters. CR is the factory setting and the most common selection.

\* **Page Full** This field controls the overwriting of characters in Graphics Alpha mode. The options include: Off, Margin 1, and Margin 2. Off permits the characters to fill the screen with no automatic control. The Margin 1 and Margin 2 settings cause the terminal to execute a "Hold Screen" function (with the XON/XOFF protocol) when the margin is reached. When the margin is reached, the screen can be cleared with the Next Scrn key which also resumes the display of characters, or the Hold Scrn key which only resumes the display. This setting is saved in NVM. A more complete discussion of Graphics Alpha mode display is given in the next section of this chapter.

- \* **Select Graphics Page** This field determines which page of graphics screen memory is used for storage and display of a screen image, either page 1 or page 2. This selection is available only on terminals with high resolution screens when they are operating in medium resolution mode.
- \* **Print Buffer** This field allows you to use part of the graphics display list memory as a printer buffer. The options available are: No, where no memory is used; 64K, or 128K, where those amounts of the display list memory are dedicated for the printer buffer. This option is available only on terminals which have graphics display list memory. Note also that the amount of display list memory is optional, up to a configuration of 512K.
- \* **Display List Data Logging** This field selects whether data received is logged into the graphics display list memory or not. The options are No, for no data logging, and Yes. This field is available only on terminals which have graphics display list memory. This is discussed in more detail in Chapter 9, *Advanced Graphics Concepts*.
- \* **Graphics Quadrant Mode** This field selects a quick method of displaying the graphics content of all four display lists at the same time by displaying them in four boxes, one in each quadrant of the screen. The options are No, for no graphics quadrant display, or Yes. This field is available only on terminals which have graphics display list memory.
- \* **Select Display List/Quadrant** This field selects which of the display lists (1, 2, 3, or 4) should be used for data logging, or for display. This field is available only on terminals which have graphics display list memory.

### Graphics Alpha Mode Screen Display

In ANSI mode operation the screen is divided into a grid of lines and columns and characters are displayed in the cells of the grid in sequential order. In graphics operation characters are displayed in a different way. First, the cell size depends on the size of the graphics alpha character selected and secondly grid location depends on the vector pixel position of the first cell. The grid is divided into two half-screen columns, called Margin 1 and Margin 2. Once the grid is located on the graphics alpha mode screen, characters are displayed sequentially, from the starting line left to right with auto wraparound down to the last line on the screen.

#### Alpha Mode Display Screen

Character Entry Grid

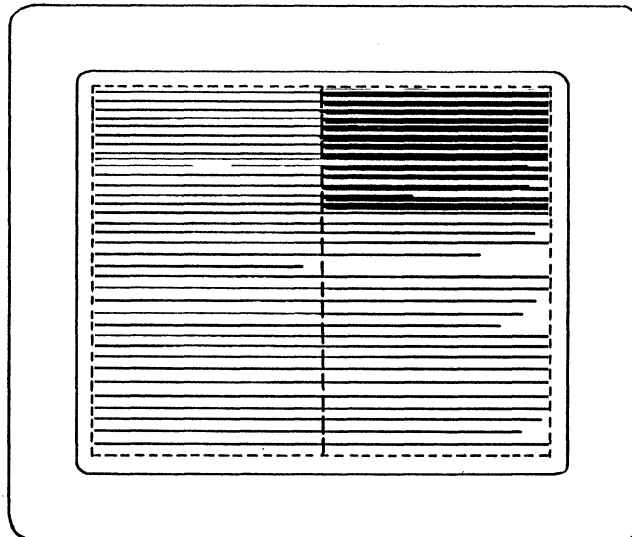

When the last line is reached the next character is displayed in Margin 2, that is, the character is entered at the top line but at the middle of the screen. Margin 2 is then filled sequentially, displaying characters from the half-screen boundary to the right edge of the screen. New characters overwrite characters already displayed. Since characters entered previously (when in Margin 1) did not wrap at the half-screen column boundary, there may be characters already in Margin 2, and these will be overwritten. Eventually, when Margin 2 is full, characters will be entered in Margin 1 again, but will overwrite any already displayed.

The **Page Full** field on the Graphics Setup Menu allows you to control the clearing and display of the graphics alpha mode screen. When either the Margin 1 or the Margin 2 option is selected, the display of characters is stopped when the margin boundary (Margin 1 or Margin 2) is reached. When the display is stopped, the screen can be cleared by pressing the Next Scrn key, or the display can be resumed without clearing by pressing the Hold Scrn key. The Hold Screen function depends on the operation of the XON/XOFF protocol, which must be enabled for this to work. The setting of this Setup Mode field is saved in NVM. The third option is Off, which disables the automatic hold function.

### **Printer Buffer From Graphics Memory**

For models of HDS3200 terminals with graphics display list memory, a printer buffer is available for Port 2. This printer buffer is selected by allocating part of the graphics display list memory for the purpose of the buffer. This selection is made from the Graphics Menu of Setup Mode as described in the previous section.

The graphics display list memory is 256K bytes, and may be expanded to 512K bytes with a memory addition. The printer buffer options are for No printer buffer, 64K bytes, or 128K bytes of memory allocated for the buffer. Depending on your use of the terminal's graphics memory for logging graphic data, this allows you to create a substantial buffer for printing tasks for both ANSI text and graphics operations.

### **GIN (Graphical Input) Mode Operation**

GIN mode, or Crosshair mode, uses input in graphical form. The crosshair is positioned on the screen either by the keyboard controls (the cursor keys) or by the movement of the mouse or the digitizer tablet.

The keyboard and the mouse/digitizer operate independently of each other. Either the mouse/digitizer or the cursor keys on the keyboard, or both devices, can be used to position the GIN mode crosshair. The cursor keys, unshifted or with the Ctrl key, move the GIN mode crosshair one pixel for each keystroke. The Shift or Ctrl Shift cursor keys move the crosshair eight pixels for each keystroke.

### **Using The Mouse And Digitizer Tablet**

The HDS3200 Series graphics terminals accept mouse input or digitizer tablet input for cursor movement in GIN mode operation of graphics. This means that you can use the movements of the mouse, instead of the cursor keys or in

addition to them, to move the GIN mode crosshair cursor. A digitizer tablet (any one of the MM Series by the Summagraphics Corp.) can be used the same way.

The mouse keys can also be used for selecting Zoom, Pan, and Draw modes when in graphics. Movement of the mouse can be used to select the Zoom factor and the position of the Pan box. These operations are described in detail in Chapter 8, *Graphics Zoom/Pan Operation*. The mouse buttons are also a convenient way to enter and exit Zoom and Pan Definition Modes and Draw the screen.

### Using The Digitizer Tablet

The HDS3200 Series terminals support a number of digitizer tablets for cursor movement in GIN mode of graphics operation. These digitizer tablets are the MM Series from the Summagraphics Corporation. These devices vary in capability and operation depending on the model selected.

The digitizers are connected the same way, with the input cable being attached to Line 3 on the back panel of the terminal. Select the appropriate option on the Port 3 Menu of Setup Mode. The communications settings for Line 3, such as baud rate, parity, etc. are all set automatically as the digitizer selected requires. Any time you disconnect the digitizer tablet, be sure to reselect the digitizer input from the Port 3 Menu or do a Clear Communications command from Setup Mode when you reconnect it.

The four buttons on the digitizer are programmable as User Defined Keys. Refer to Chapter 4, *User Defined Function Keys*, for details. The configuration of the keys on the digitizer, or pen, may be different, but should follow this general pattern. The factory assignments for the digitizer keys are the same as those of the mouse in GIN mode, but since the digitizer cannot change its tracking ratio, the definitions have no meaning. The digitizer is not used for Zoom and Pan Mode operations or with Setup Mode.

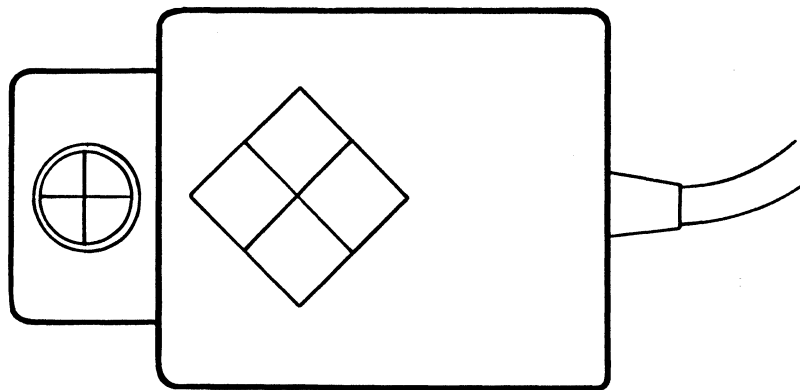

## HDS3200 Owner's Manual

Subtract	PF2	-
Multiply	PF3	*
Divide	PF4	/
Memory Add (M+)	F17	
Memory Subtract (M-)	F18	
Memory Clear (MC)	F19	
Memory Recall (MR)	F20	
Clear Entry (CE)	-	
Clear Accumulator (C)	,	
Equals	ENTER	Return
Send Accumulator,Exit	DO	Backspace or Delete
Erase Previous Keystroke		<u>Comp Char</u>
Exit	HELP	

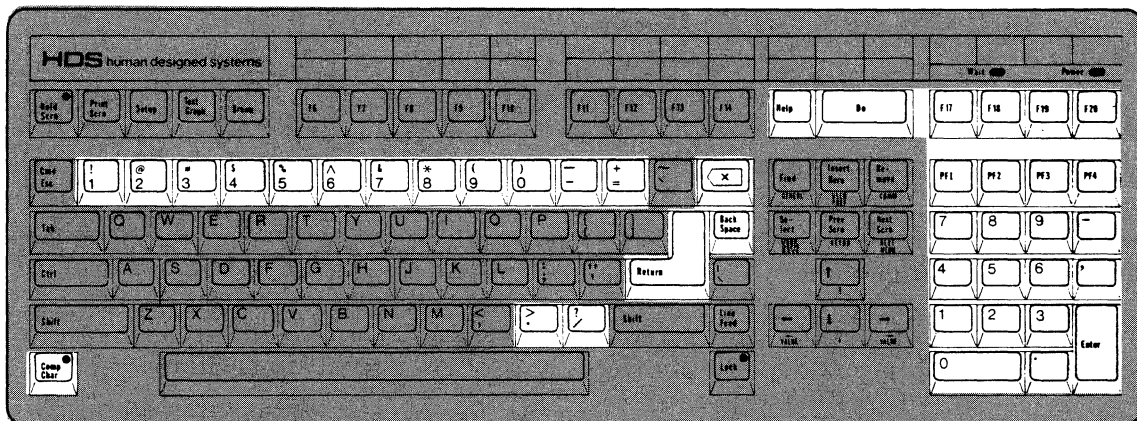
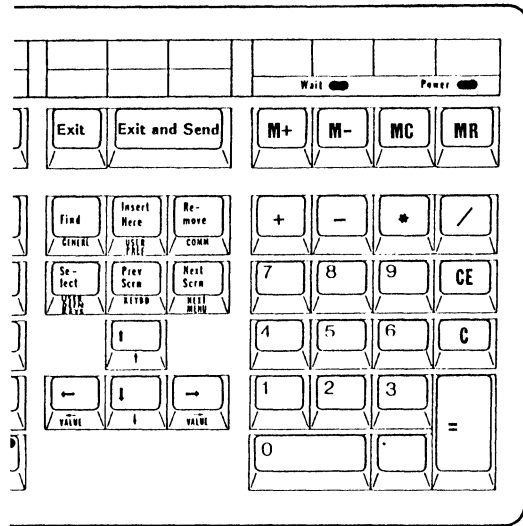
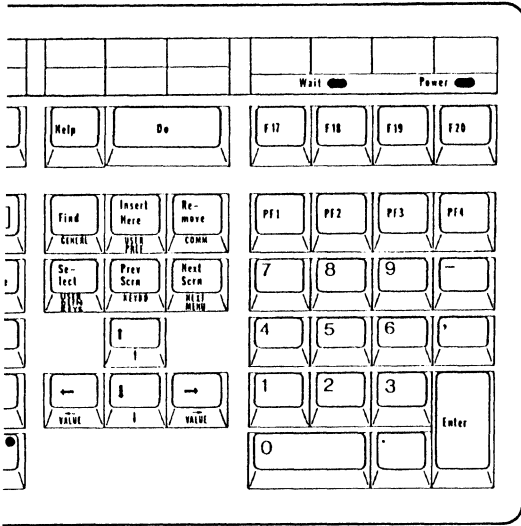

These keys operate like normal calculator keys to enter data and calculate a result. The result is shown on the screen in a display line. This result can be sent to the host computer by pressing the Do key. The Backspace and Delete keys remove the last character you typed, so you can correct an error without clearing the entire entry. You can exit Calculator mode by pressing the Help or Comp Char keys.

Chapter 6

**On-Screen Calculator**

*SUMMARY On-Screen Calculator*

*This chapter describes the function of the on-screen calculator and the keys it uses on the keyboard.*

**Calculator Mode**

Calculator Mode is a special operating mode of the terminal, much like Setup Mode, during which only those keys that belong to the on-screen calculator are active, generally keys in and around the Numeric Keypad. While the terminal is in Calculator Mode communications with the host computer are temporarily suspended. Be sure to have the XON/XOFF protocol enabled when you use Calculator Mode.

You enter Calculator Mode by pressing the *Comp Char* key and then the *Enter* key. Part of the screen (the part not currently occupied by the cursor) is temporarily replaced by showing the keys which perform the calculator functions and current values for the entry and the memory.

HDS Calculator	Display	<table border="1"> <tr> <td>M+</td> <td>M-</td> <td>MC</td> <td>MR</td> </tr> <tr> <td>+</td> <td>-</td> <td>*</td> <td>/</td> </tr> <tr> <td>7</td> <td>8</td> <td>9</td> <td>CE</td> </tr> <tr> <td>4</td> <td>5</td> <td>6</td> <td>C</td> </tr> <tr> <td>1</td> <td>2</td> <td>3</td> <td></td> </tr> <tr> <td>0</td> <td></td> <td>.</td> <td>=</td> </tr> </table>	M+	M-	MC	MR	+	-	*	/	7	8	9	CE	4	5	6	C	1	2	3		0		.	=
M+	M-		MC	MR																						
+	-		*	/																						
7	8		9	CE																						
4	5		6	C																						
1	2		3																							
0		.	=																							
	12345.67																									
	Memory																									
Help: Exit	222222.22																									
Do: Exit and Send																										

**Calculator Functions**

The Calculator performs all the standard calculator functions: addition, subtraction, multiplication, and division. It also has a separate memory.

The following chart gives the calculator function and the key used to generate it. Note that some keys are available on both the numeric and the main keypads, and that in one case (minus) the keys are not equivalent.

Function	Numeric Keypad	Main Keypad
Numerals	0-9	0-9
Decimal Point	.	.
Add	PF1	+

Chapter 7

## HDS Mouse Operation

### *SUMMARY HDS Mouse Operation*

*This chapter describes the setup of the HDS mouse and summarizes the different settings it uses in the various operating environments of the terminal. The mouse keys and their key definitions are given.*

A mouse is an easy and convenient way to generate input for the terminal. The mouse registers its movements onto the terminal screen, a capability which is used to advantage in GIN mode of graphics and in selecting a particular line from the Setup Menu. The mouse buttons also have assignments suited to their particular operating mode. These factory assignments are discussed in detail below, but the mouse buttons are programmable like other User Defined Keys.

### Setting Up The HDS Mouse

There are three simple steps to set up the mouse. First, you must position the ball in the bottom of the mouse; second, you must connect its cable to Port 3 of the terminal; and third, you must select Mouse input on the Port 3 Menu of Setup Mode. Each of these steps is discussed in detail below.

The mouse is shipped with the ball separate from the mouse. You assemble it by dropping the ball into position and slipping the retaining ring over it. The retaining ring rotates about a quarter turn clockwise to tighten.

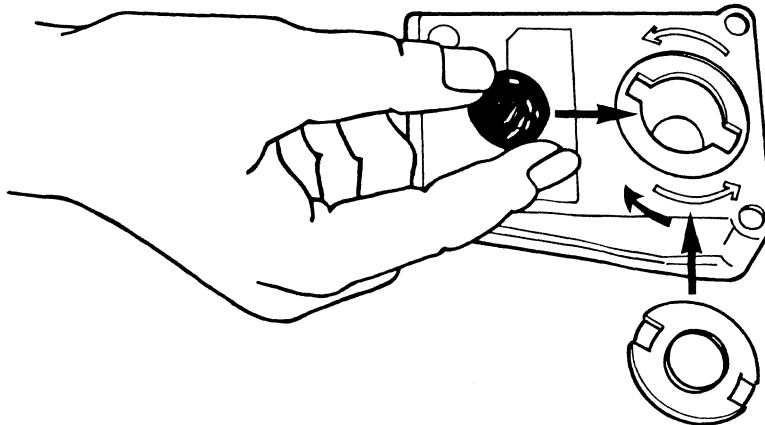

After prolonged use the ball may become dirty or clogged with lint. You can clean the ball by removing the retaining ring (turn counter-clockwise and lift off) and removing the ball from its socket. Clean the ball with mild, soapy water. Avoid solvents and abrasives. Dry the ball with a lint-free cloth. Clean the ball socket carefully if necessary. Replace the ball in its socket and tighten the retaining ring. The ball should move freely and easily in the housing.



The second step is to connect the cable of the mouse to the RS-232 connector for Line 3 on the back panel of the terminal. Screw in the mouse cable connector. Any time you disconnect the mouse, be sure to reselect the Port 3 Input as Mouse input or do a Clear Communications command from Setup Mode when you reconnect it.

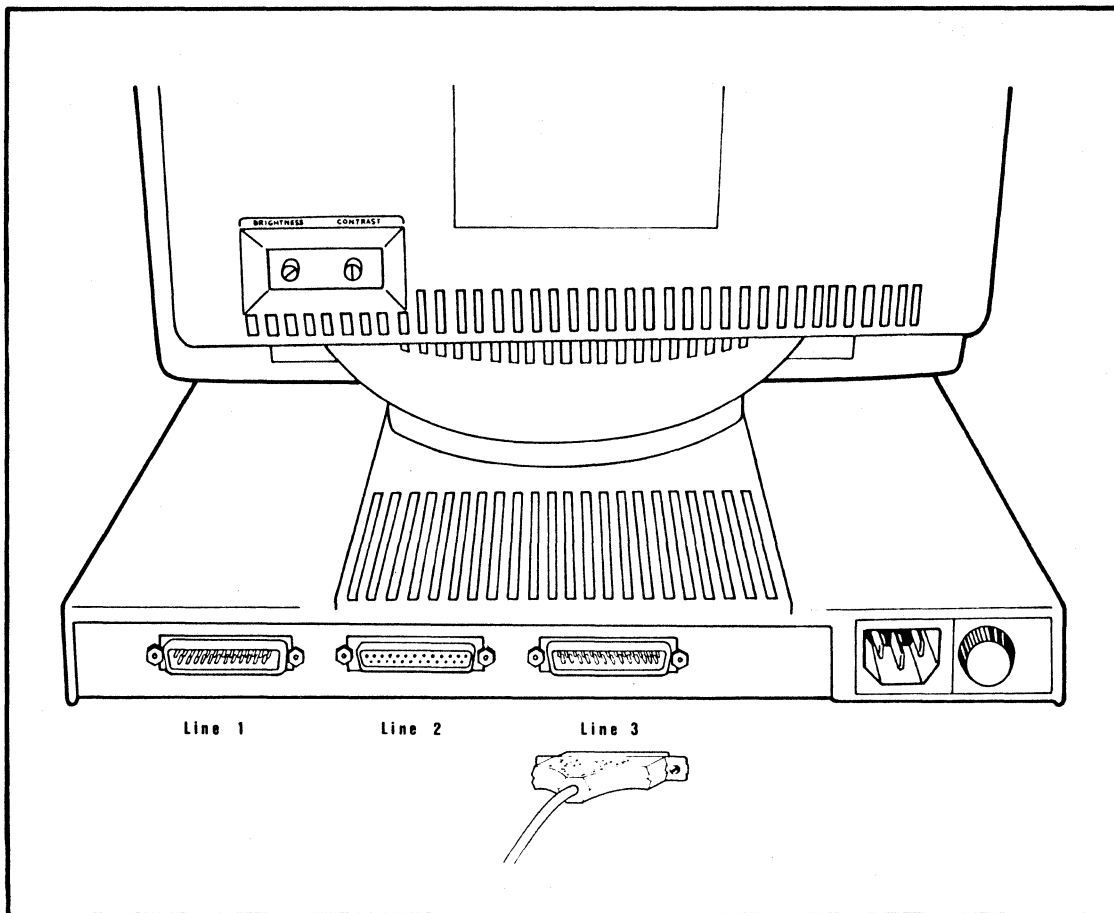

The last step is to go into Setup Mode, go to the Communications Menu, select Port 3, and then select the appropriate setting for the **Port 3 Input From:** and **Mouse Active** fields. The Setup Mode fields are:

\* **Port 3 Input From** This field designates what kind of device is connected to Port 3. The options are: Mouse input (the factory setting), four selections for digitizer tablets (MM Series and Bit Pad One by Summagraphics), and Normal (RS232), which designates a normal Port 3 connection and communication.

The Mouse and digitizer tablet options instruct the terminal to interpret the data from the mouse or digitizer as cursor movements on the screen. The Normal (RS232) option is for intelligent device communication to Port 3 and requires the host software to interpret the data communicated to the Port.

The digitizer options are for Summagraphics models MM1201 (full pad) in which the entire pad height corresponds to the 780 pixel height of the screen, MM1201 (partial pad) in which the 1024 x 780 screen dimension is mapped exactly onto the pad (leaving the upper part of the pad unused), MM1812/961 pads, or Bit Pad One digitizer tablets.

## HDS3200 Owner's Manual

For normal (RS-232) Port 3 operation, you must set the baud rate and other communications settings for Port 3 as needed. For the Mouse and Digitizer options, these settings are selected automatically and will change any Port 3 configuration already set. The user should not change the settings for the mouse or the digitizer.

\* **Mouse Active** This field selects when the mouse is active. The options are: Graphics, and Graphics and ANSI. When Graphics is selected, mouse activity is interpreted when the terminal is in Graphics mode and Setup mode. When Graphics and ANSI is selected, mouse activity is registered all the time, in ANSI text mode for cursor movement, in Setup mode, and in Graphics mode.

The three buttons on the mouse and the four buttons on the digitizer are programmable as normal User Defined Keys either in Setup Mode or by HDS terminal commands. They accept definitions for the button Up or button Down positions, for either RAM or NVM definitions, and for either ANSI or graphics mode operation. Refer to Chapter 4, *User Defined Function Keys* for details.

### Using The Mouse Buttons

The mouse is easy to use when you hold it lightly in your palm with the cord going away from you. Use the mouse on a smooth, flat surface. The surface should be clean, clear of obstructions, and convenient for your hand movements. As you move the mouse on this surface, the movement is copied on the screen, for instance by the GIN mode cursor in graphics mode. A large movement left with the mouse produces a large movement left with the cursor. (The degree of movement is controlled by the "tracking ratio", which is discussed briefly below and more completely in the *HDS3200 Programmer's Reference Manual*). You can pick up the mouse and reposition it on the surface; the mouse registers only movements relative to its last position. You'll find the mouse an easy device to use.

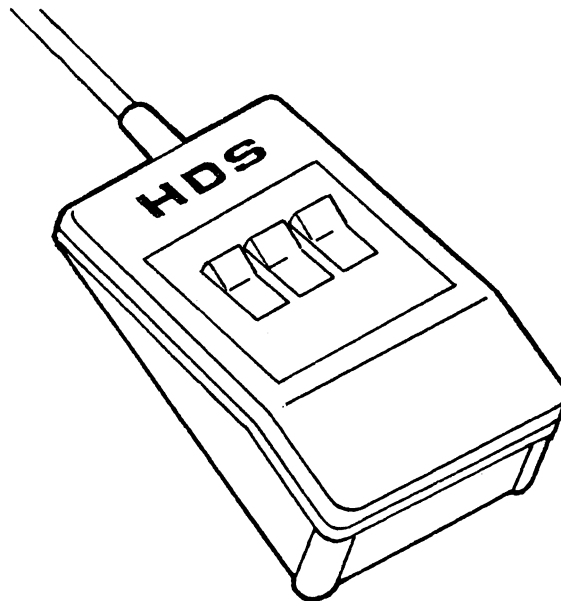

In this position the buttons on the mouse are at your fingertips. The buttons are similar in operation to normal User Defined Keys, except the buttons have different definitions in graphics mode and its other operating modes, as discussed below. The buttons are Left, Middle, and Right.

The mouse buttons can be given user definitions like any other User Defined Keys. Refer to later sections of this chapter or Chapter 4, *User Defined Function Keys*, of this manual for details. Note that the Up position of the mouse buttons are programmed in Setup Mode by using the Comp Char key. When a user definition is assigned, it overrides the text and the GIN mode definitions described above but not the definitions used for Setup Mode and Zoom/Pan Definition Modes.

### Mouse Operation In Setup Mode

The Mouse is active in Setup Mode, both for cursor movement and with the mouse buttons. Vertical movements of the mouse move the selected field line (indicated by the bold display) up and down the Menu displayed on the screen. Horizontal movements of the mouse are ignored since they have no purpose. The tracking ratio is fixed at 1:1.

The mouse buttons have useful definitions. The Middle button selects the Next Menu. The Left and Right buttons select the next option for the currently selected field. Of course the mouse buttons are not active for fields that require data entry, such as entering the User Defined Key definitions, window definitions, or the Answerback Message.

A different operating behavior applies when the mouse is used in the Editing Tabs field on the General Setup Menu. The Tabs Editing field displays a reverse video line of numbers representing the screen columns with tab settings shown in normal display. Horizontal movement of the mouse moves the cursor along the displayed line and either the Left or Right buttons toggle the tab setting of the currently selected column. The Middle button selects the next Setup Mode field, and so exits Tab Editing.

### Using The Mouse For Cursor Movement

In text or ANSI mode operation, the HDS3200 terminal recognizes the movement of the mouse as normal cursor movement. This means the mouse can be used to relocate the cursor in a block of text just as if you were using the keys in the cursor keypad. The tracking ratio of the mouse is 1:1 and is automatically adjusted to compensate for 80/132 column or 25/50 line screen definitions so the same mouse movements cover the same screen areas.

The mouse buttons have the same factory assignments in text mode operation as they have in GIN mode of graphics, that is, the mouse keys change the tracking ratio of the mouse. All three keys have the same definition. Pressing the key down increases the current tracking ratio by a factor of 2. The change occurs on the change of state of the key, so you must press the key and hold it down for as long as you want the doubled tracking ratio. When you release the key, the definition is changed again and the ratio is decreased by a factor of 1/2, which means that the original setting is restored.

### The Mouse In Zoom/Pan Definition Modes

The HDS mouse is a convenient device to control the Zoom, Pan, and Draw functions of the terminal. (These functions are only available on HDS3200 terminal models with graphics Display List memory.) The movements of the mouse control the movement of the Zoom and Pan boxes and the mouse buttons are defined to execute Zoom, Pan, and Draw functions. Note that these definitions are specific to Zoom and Pan Definition Modes. Other definitions apply when the mouse is used in other operating modes, specifically in GIN mode of graphics. Therefore, if you want to use Zoom and Pan Definition Modes while in GIN mode, you must use the keyboard keys to give the commands.

The mouse buttons are defined to enter and exit Zoom and Pan Definition Modes. The buttons are used by pressing them and releasing them. The Left button enters and exits Zoom Definition Mode, the equivalent of Comp Char Z. The vertical movement of the mouse changes the Zoom factor to larger or smaller values. Left and right movements of the mouse are ignored in Zoom Definition Mode, since they would generate anisotropic Zoom factors, which are discussed in Chapter 8, *Graphics Zoom/Pan Operation*.

The Right mouse button enters and exits Pan Definition Mode, the equivalent to Comp Char P. The movement of the mouse up or down, right or left moves the Pan box on the screen.

The Middle button executes the Draw function, the equivalent of Comp Char D.

### The Mouse In GIN (Graphical Input) Mode

The mouse operation in GIN mode is the same as in text mode, with the exception that the cursor is a GIN mode crosshair and the screen image is a graphics image instead of lines of text. The movements of the mouse are interpreted by the terminal as movements of the cursor on the screen (as if they were produced by the arrow keys in the cursor keypad). The definitions of the mouse buttons are the same, that is, the three buttons are all defined to change the tracking ratio of the mouse. The down stroke increases the tracking ratio by a factor of 2 and the up stroke decreases it by a factor of 1/2.

### Mouse Key Programming

The three buttons on the mouse and the four buttons on the digitizer are programmable. Their definitions are available either in text or graphics mode operation, can be selected as either RAM or NVM definitions, and can be programmed either from Setup Mode or by the HDS UDK terminal command. The Setup Mode and the Zoom and Pan Definition Mode definitions for the mouse buttons are not changed by user definitions.

The mouse has three buttons and each has two Key Numbers, one for the Up and one for the Down position. In Setup Mode the Up position of the mouse key is programmed by pressing the Comp Char key and then the mouse key. The Down position is programmed by pressing the key alone. The digitizer tablet buttons are programmable with only one definition each.

Programming the mouse keys is different from regular keys in one respect because the keys have both an Up and a Down definition. This situation arises because the keys change their definition when the key changes state, that is, on the down stroke or the up stroke. This means that the key must be pressed down and held down to use the Down definition, since releasing the key results in an up stroke and the redefinition to the Up definition. A caution should be mentioned: if you are programming just one definition on the key, you can do it simply by using the Down definition, or using the Down definition and using something to be ignored on the Up definition. In the factory setting, the Down and Up definitions are complementary settings of the tracking ratio, so press and release of the key results in the original tracking ratio setting. Problems can result in programming only the Up definition. Note also that programming the mouse keys removes the default definitions of the mouse tracking ratio changes used in ANSI and GIN mode operation.

## Chapter 8

### Graphics Zoom/Pan Operation

#### *SUMMARY Graphics Zoom/Pan Operation*

*This chapter describes the Zoom and Pan functions and the operation of Zoom and Pan Definition Modes, including the keys and mouse used in these operating modes. The emphasis is on the operation of Zoom/Pan Definition Modes, not the concepts or techniques underlying its function. The chapter describes the operation of zoom controls and the zoom box. The use of pan controls, the pan box, and the behavior of the pan box with a zoomed image is also discussed. The chapter also describes returning the graphics screen to normal with the Times 1 function.*

#### **Zoom And Pan Functions**

Zoom and Pan refer to special capabilities of the terminal for modifying the display of a graphics image. These capabilities are only available on terminal models with advanced graphics features, specifically with graphics Display List memory, which can be checked by looking on the Graphics Setup Mode Menu.

Zoom refers to a change in the magnification of the image, presenting it in either larger or smaller sizes when it is displayed on the screen. Pan refers to a change in the part of the image displayed, presenting (for instance) either the upper or lower parts of the larger image. These two operations can be used together to increase your ability to examine or manipulate a graphics image on the screen. The image itself is stored in a special part of graphics memory called the Display List. The Display List, and the process of storing graphics data in it (called Data Logging), is discussed in the next chapter.

The graphics image stored in the terminal's memory is not changed or modified by these Zoom and Pan operations. These operations are display capabilities of the terminal itself and leave the basic image unchanged. Zoom and Pan operations are related only to the way the terminal manipulates the contents of its graphics memory for display on the screen.

#### **Zoom And Pan Definition Modes**

Zoom and Pan are special graphics operations which are available as an option on HDS3200 Series terminals. You can look for these Zoom and Pan graphics features by checking the Graphics Setup Menu. If you see Setup lines for Data Logging, Graphics Quadrants, and Display Lists, your terminal is equipped with advanced graphics features including Pan and Zoom capabilities. If those Setup lines are not present, your terminal can be upgraded to add Pan and Zoom graphics capabilities.

The Zoom function allows you to select an area of the graphics screen (which is outlined by the Zoom box) and enlarge or reduce its size. The Pan function allows you to indicate a viewing area on the screen (marked by the Pan box) and then move that Pan box across a graphics image, up/down, right/left to the area

you want to see. Both of these operations are available only in special operating modes of the terminal called Zoom (or Pan) Definition Modes.

Zoom and Pan Definition Modes are special operating modes of the terminal much like Setup Mode. When you are in Zoom/Pan Definition Mode most normal terminal activities are temporarily suspended and only certain keys, including the mouse keys, are active. Another operation, the Times 1 function, is available to return the screen to its original presentation, exit Zoom/Pan Definition Modes, and return the terminal to normal operation. The following keyboard diagram shows the keys which are active in Zoom and Pan Definition Modes.

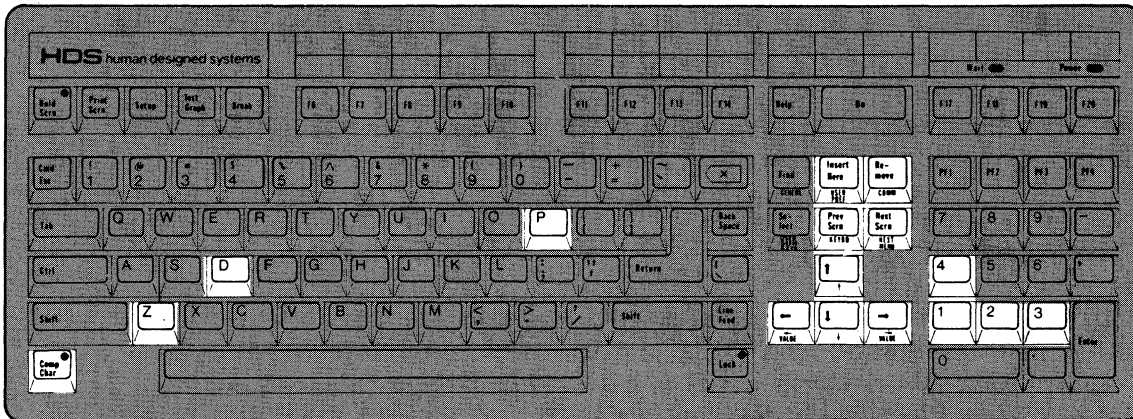

### Using Zoom Definition Mode

You enter Zoom Definition Mode by pressing the Comp Char key and then the Z key, either "Z" or "z". You exit Zoom Definition mode by pressing the same keys, or the Remove key. You can enter Zoom Definition mode from either Graphics mode or from Pan Definition Mode.

When you first enter Zoom Definition Mode a box (the Zoom box) is drawn with a solid line around the border of the screen. This box encloses your graphics image, in this case the entire graphics screen, since your zoom factor is 1. The Zoom box defines the area of the screen to enlarge or reduce.

You can change the zoom factor, the factor of enlargement or reduction, by using the cursor movement keys or the mouse. The up arrow key, or an upward movement of the mouse, increases the zoom factor with each keystroke, up to a zoom factor of 16. The increased zoom factor results in a smaller zoom box on the screen because the area enclosed by the zoom box will be the entire screen when the image is redrawn. Notice that the zoom box keeps the center of the screen for its reference point.

Pressing the down arrow key or a downward movement of the mouse decreases the zoom factor, down to a factor of 1/16. In this case the Zoom box may disappear from the screen, since the visible screen represents only a small part of the new image enclosed by the Zoom box.

At this point you can draw the image enclosed by the Zoom box onto the whole display screen by using the Draw function, which is activated by pressing the Comp Char D, or Comp Char d or Next Scrn keys. This new image is the enlarged

## HDS3200 Owner's Manual

or reduced area enclosed by the Zoom Box. When the Draw function is used the terminal is no longer in Zoom Definition Mode.

You can also exit Zoom Definition Mode without drawing the screen by pressing the Comp Char and Z keys, or by using the Remove key.

Try this simple example. Use a graphics image that fills the screen, or imagine a map of the United States on the terminal screen.

Enter Zoom Definition Mode by pressing Comp Char Z. The Zoom box will appear around the outside edge of the screen.

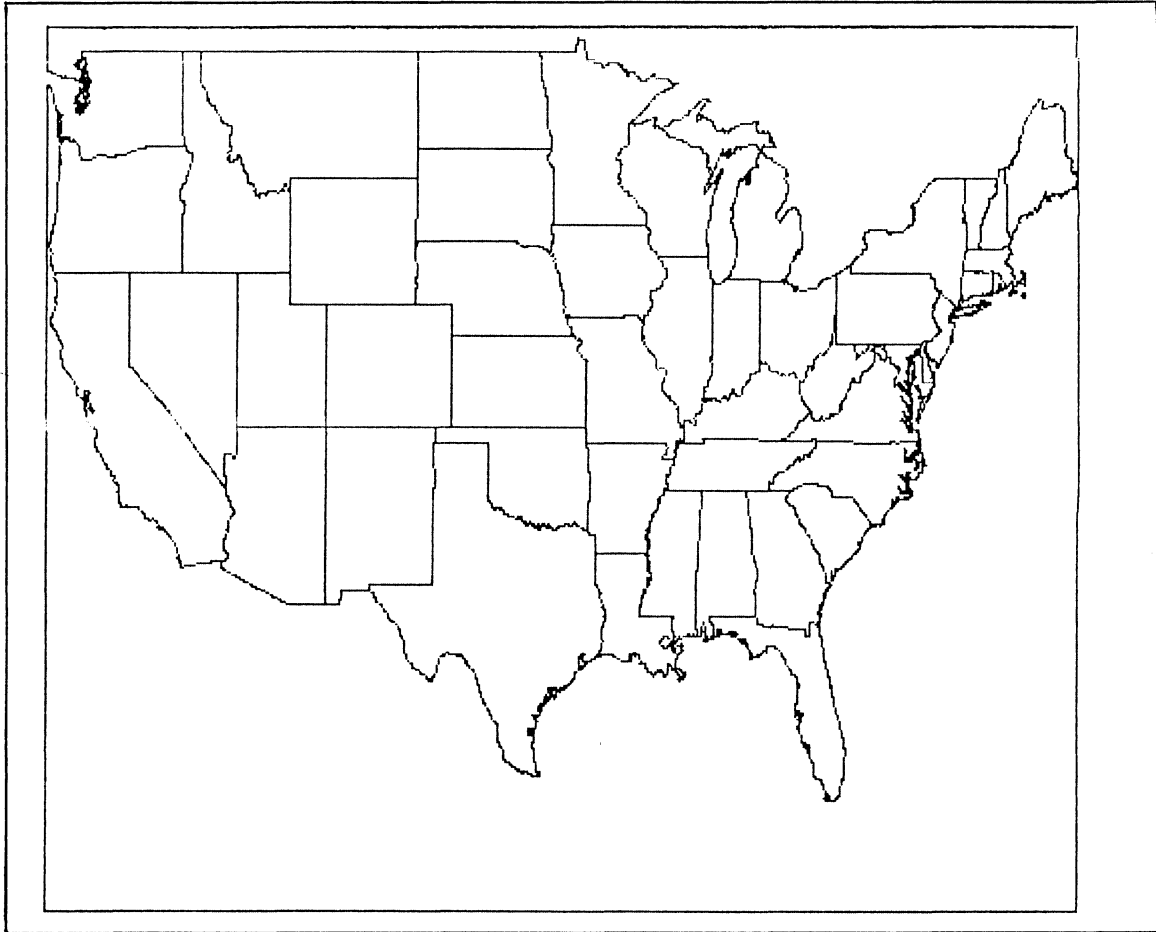

**Map with Zoom Box (zoom factor = 1)**

Press up arrow two or three times. The Zoom box will be reduced in size and located in the center of the screen.

Draw the screen with the new zoom factor by using the Draw function; press Comp Char D. The map will be redrawn with an enlarged view of Kansas on the screen.



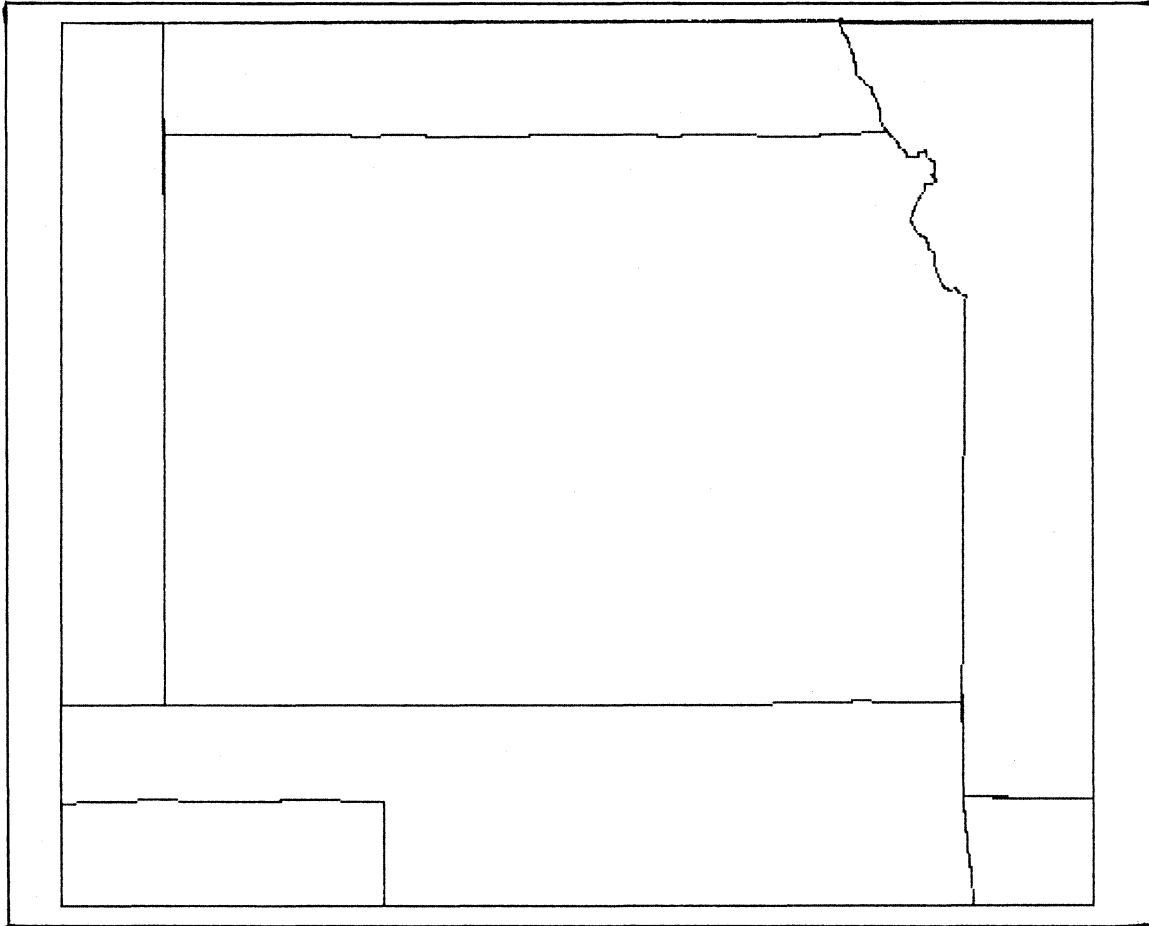

**Map redrawn with zoomed image**

When the image defined by the Zoom or Pan boxes is drawn, either to the new magnification or the new location, the graphics image is redrawn with the new magnification. This magnification is not merely the enlargement of the pixel arrangement already on the screen (as with some graphics terminals), but a reconstruction of the graphics image at a higher resolution, so points or vectors too close to each other to be resolved in the original display are now resolved by the higher magnification.

#### **The Times 1 Draw Function**

You can return to the original state of the graphics image from any zoomed or panned position by using the Times 1 function, whether the terminal is in Zoom or Pan Definition Mode or not. You can use the Times 1 function by pressing the Comp Char 1 keys or the Prev Scrn key. The Times 1 function will return to the original image regardless of how many or what type of Zoom or Pan operations you performed. The Times 1 function also exits Zoom and Pan Definition Modes.

**Using Pan Definition Mode**

You enter Pan Definition Mode by pressing the *Comp Char P* keys, either "P" or "p". You can enter Pan Definition Mode from normal graphics terminal operation or from Zoom Definition Mode. When you enter Pan Definition Mode a Pan box appears at the outside edges of the screen. The Pan box is indicated by dotted lines. The Pan box can be moved (or panned) left or right, up or down across the graphics image by means of the cursor movement keys or the mouse.

Commonly, Pan Definition Mode is used together with Zoom Mode, as in the example that follows:

Imagine the graphics screen filled with a map of the United States.

Enter Zoom Definition Mode (*Comp Char Z*).

Select the amount of zoom you want for your display (press *up arrow* until the zoom box is the right size). In this example, the Zoom box shrinks to enclose Kansas.

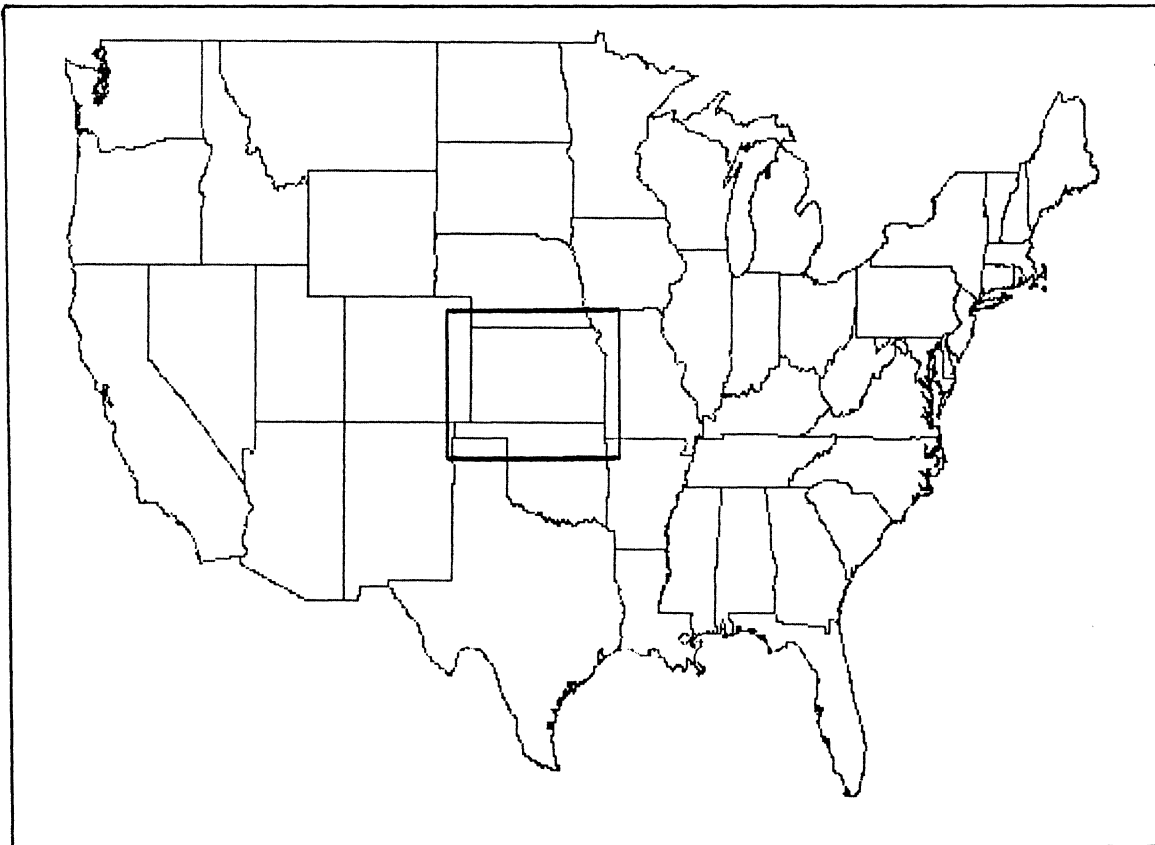

**Map with Zoom Box shown**

## HDS3200 Owner's Manual

Enter Pan Definition Mode before exiting Zoom Definition Mode or drawing the screen (press Comp Char P). The Zoom box (solid line) changes to a Pan box (dotted line).

Now use the cursor movement keys, or the mouse, to move the Pan box to some other location (directly left on the screen to include San Francisco Bay, or right and up to include Cape Cod in Massachusetts). Because the screen is still shown in its full size, you can easily see where the Pan box is located on the entire image. Note that if you pan down or left, the Pan box stops at the edge of the screen, but the Pan box will go off the screen to the top or right. This is because the image's origin (0,0) is at the lower left while the upper corner is at (1024,1024).

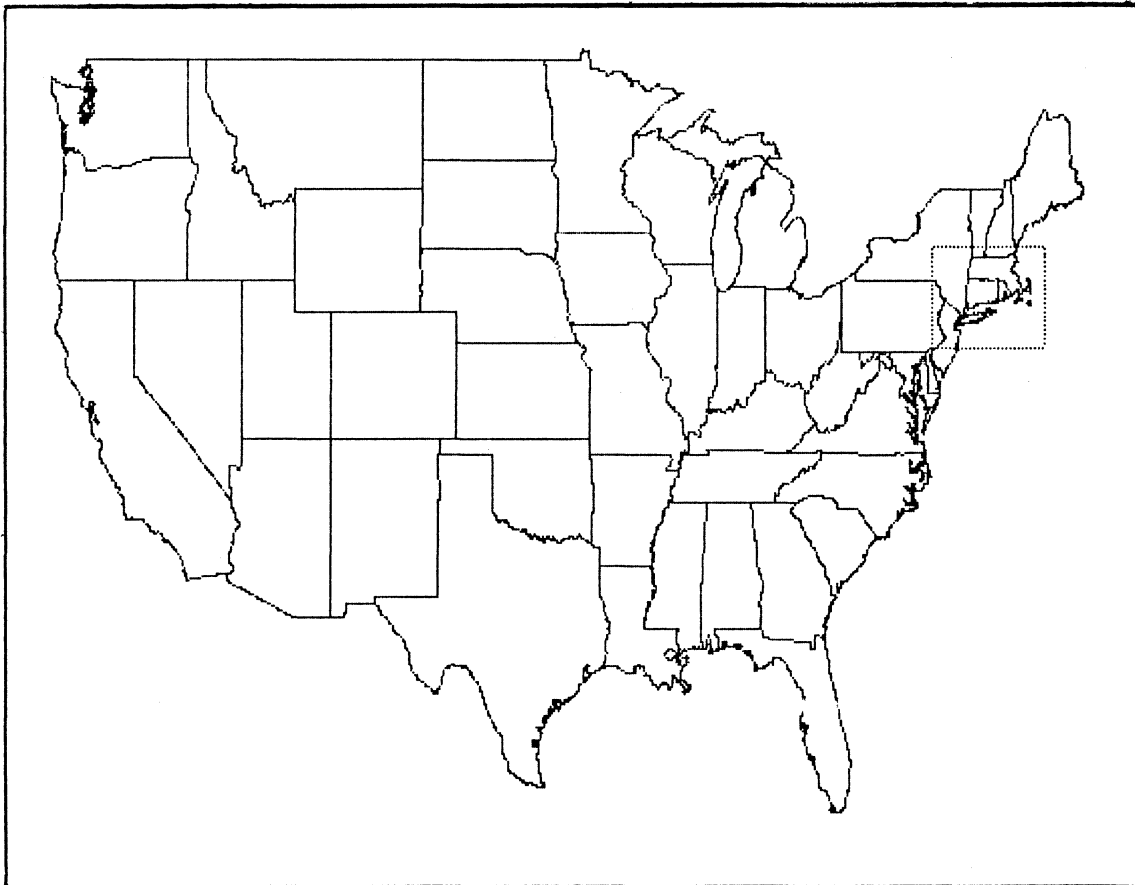

**Map with Pan Box shown**

When the Pan box is located to enclose the area you want to see, use the Draw function (press Comp Char D) to draw the image with its new location and zoom factor. This exits Pan Definition Mode. The Remove key will exit Pan Definition Mode without making any of the changes, either in location or drawing.

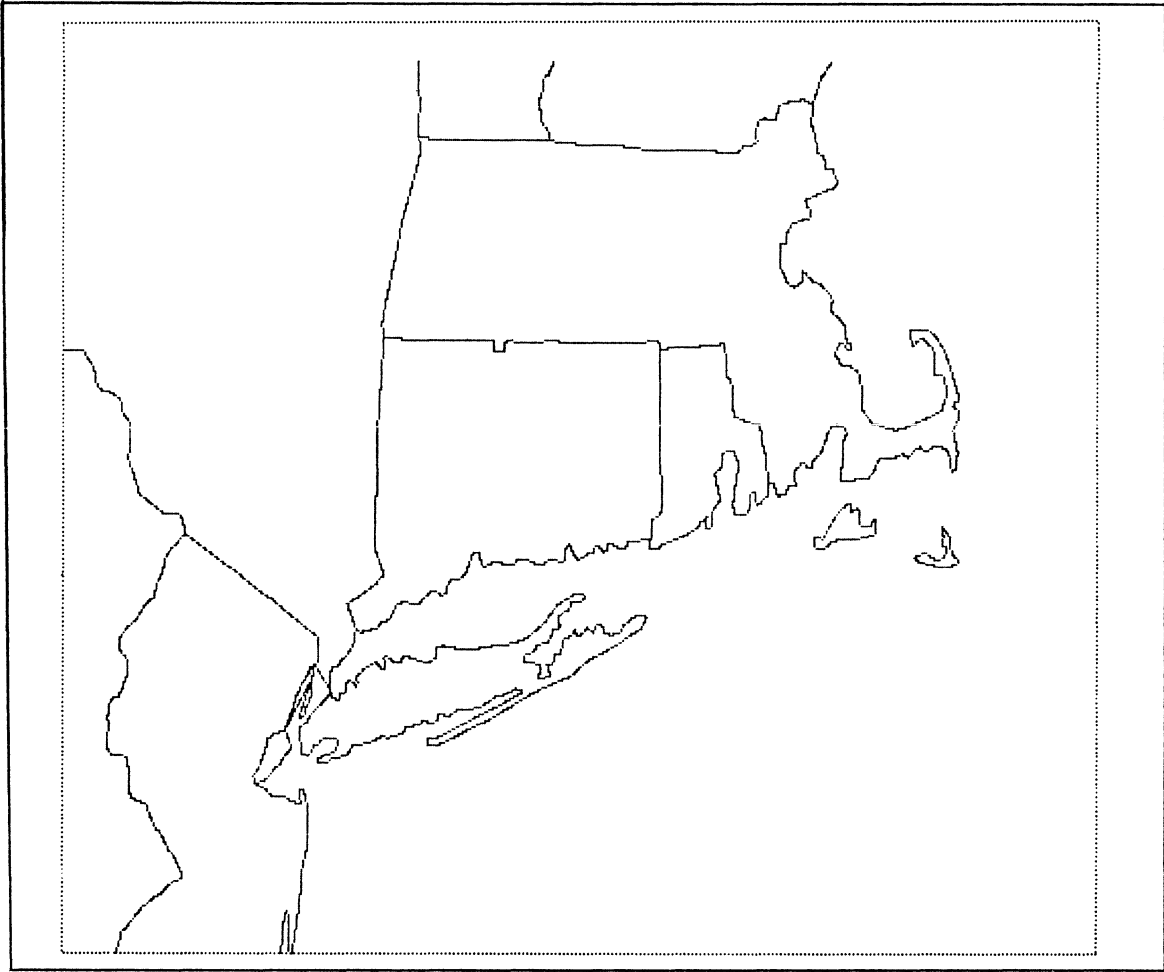

Map redrawn to show zoomed and panned image

#### **The Mouse In Zoom/Pan Definition Modes**

The HDS mouse is a convenient device to control the Zoom, Pan, and Draw functions of the terminal. The movements of the mouse control the movement of the Zoom and Pan boxes and the mouse buttons are defined to execute Zoom, Pan, and Draw functions. Note that these definitions are specific to Zoom and Pan Definition Modes. Other definitions apply when the mouse is used in other operating modes, specifically in Setup Mode and GIN mode of graphics.

The mouse buttons are defined to enter and exit Zoom and Pan Definition Modes. The buttons are used by pressing them and releasing them. The Left button enters and exits Zoom Definition Mode, the equivalent of Comp Char Z. The vertical movement of the mouse changes the Zoom factor to larger or smaller values. Left and right movements of the mouse are ignored in Zoom Definition Mode, since they would generate anisotropic Zoom factors, which are discussed in the next section.

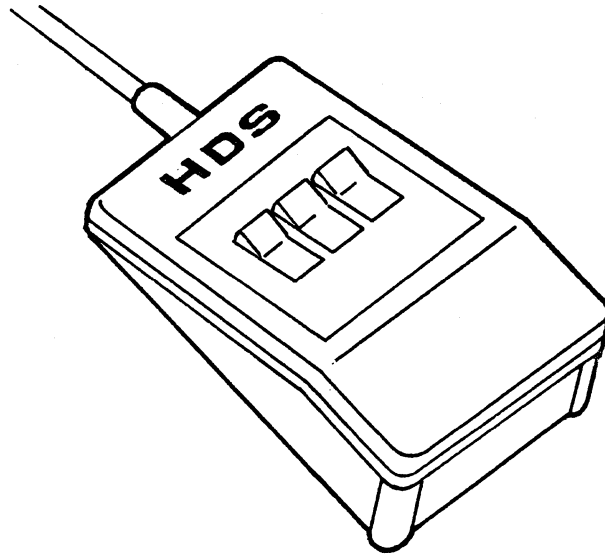

The Right mouse button enters and exits Pan Definition Mode, the equivalent to Comp Char P. The movement of the mouse up or down, right or left moves the Pan box on the screen.

The Middle button executes the Draw function, the equivalent of Comp Char D.

### Anisotropic Zoom Controls

It is possible to expand the zoom box anisotropically, that is, with the X (horizontal) and Y (vertical) zoom factors having different values. In normal operation the zoom factor maintains  $X = Y$  so the proper graphic relationship of the image is preserved. In some cases you may want to change these factors individually. This can be done from Zoom Definition Mode with the right arrow and left arrow keys, which change the value of X only, either increasing or decreasing X while leaving Y unchanged.

For instance, suppose you enter Zoom Definition Mode (press Comp Char Z), change the zoom factor (press up arrow to select the desired zoom factor), then increase or decrease the X direction zoom factor by pressing the right arrow key or the left arrow key as needed. This last step increases the zoom factor in the X direction only and shows an anisotropic zoom factor. When the screen is drawn this aspect ratio is maintained. The zoom box now fills the entire screen, and the graphics image is stretched or compressed along the X axis. This technique might be useful for sizing a chart or bar graph, but obviously has less utility in dealing with representational images such as the US map used in the earlier examples.

### Keys Active In Zoom/Pan Definition Modes

The following illustration and list shows the keyboard keys which are active in Zoom and Pan Definition Modes. This list also acts as a summary of the commands available in these modes.

**Zoom Definition Mode**

<b>Function</b>	<b>Key</b>
Enter/Exit Zoom Definition Mode	<u>Comp Char Z</u> <u>Comp Char z</u> also Mouse Left button
Increase Zoom factor, 1 to 16	<u>up arrow</u>
Decrease Zoom factor, 1 to 1/16	<u>down arrow</u>
Increase X Zoom factor, 1 to 16	<u>right arrow</u>
Decrease X Zoom factor, 1 to 1/16	<u>left arrow</u>
Enter Pan Definition Mode	<u>Comp Char P</u> also Mouse Right button
Draw screen; exit Z/P modes	<u>Comp Char D</u> <u>Comp Char d</u> also <u>Next Scrn</u> also Mouse Middle button
Times 1 function; return to original image	<u>Comp Char 1</u> also <u>Prev Scrn</u>
Exit Zoom/Pan Definition Mode; screen display unchanged	<u>Remove</u>
Toggle Data Logging On/Off Immediately	<u>Shift Insert Here</u>
Toggle Data Logging after ESC FF	<u>Insert Here</u>

**Pan Definition Mode**

<b>Function</b>	<b>Key</b>
Enter/Exit Pan Definition Mode	<u>Comp Char P</u> <u>Comp Char p</u> also Mouse Right button
Move Pan box up	<u>up arrow</u>
Move Pan box down	<u>down arrow</u>
Move Pan box right	<u>right arrow</u>
Move Pan box left	<u>left arrow</u> (shifted arrow keys move faster)
Enter Zoom Definition Mode	<u>Comp Char Z</u> also Mouse Left button
Draw screen; exit Z/P modes	<u>Comp Char D</u> <u>Comp Char d</u> also <u>Next Scrn</u> also Mouse Middle button
Times 1 function; return original image	<u>Comp Char 1</u> also <u>Prev Scrn</u>
Exit Zoom/Pan Definition Mode; screen display unchanged	<u>Remove</u>
Toggle Data Logging On/Off Immediately	<u>Shift Insert Here</u>
Toggle Data Logging after ESC FF	<u>Insert Here</u>

### Using Zoom/Pan Within An Application Program

The Zoom and Pan functions described in this chapter are all local functions of the terminal. The graphics image may be received by the terminal from the host computer (with or without Data Logging, as discussed in the next chapter), but the processing and redrawing of the image are done independently of the host. While you are using Zoom/Pan Definition Mode, the terminal temporarily suspends its communication with the host, just as if the Hold Scrn key were pressed. If the Buffer Overflow Protocol is working correctly, this should present no problems to the host computer or to the activity of the application program the host is running. However, it is always prudent to verify the correct operation of the communications protocols if there are problems.

When a panned or zoomed image is displayed on the screen and you are no longer in Zoom or Pan Definition Mode, you can manipulate that image with the tools of the graphics application program. The host computer and the application program are unaware of the form or origin of the image, but act only on the image as it appears on the screen. The original image, that is, the addresses and vectors that generated the image, is preserved in the terminal's graphics memory unchanged by this other activity. This is discussed in more detail in the following chapter.

Another independent activity of the terminal is the Print Screen function. This is a transmission of the current contents of the terminal's screen to the printer, without the intervention of the host or printing utilities. By using this Print Screen function, you can send the current contents of the screen, such as a zoomed or panned image (with the Zoom box shown if you print before drawing the screen), at any time by using the local capabilities of the terminal. You can use the Print Screen function by pressing the Print Scrn key, after making sure that the printer is On and ready.

## Chapter 9

### Advanced Graphics Concepts

#### *SUMMARY Advanced Graphics Concepts*

*This chapter discusses concepts of terminal operation as they apply to graphics operations. The concepts focus around the storage of a graphics image in memory, its projection onto the screen, and the manipulations available in the process.*

#### Storage Of A Graphics Image

The picture displayed on a terminal screen is a transient thing. Once the picture is on the screen, it is held in the screen's memory as a set of pixels either on and off, and its origin (whether from the keyboard or the host computer) and its original form (whether constructed from points or vectors) are unknown.

This screen memory is one type of graphics memory. On high resolution terminals there are two pages of screen memory, Page 1 and Page 2, usually called Graphics Memory, that can hold an image for display on the screen. These two pages of memory are controlled by the Select Graphics Page line of the Graphics Setup Menu. Access to these two pages of memory is available only on high resolution terminals that are operating in medium resolution mode. They are mentioned here to avoid any confusion with other graphics memory storage discussed in the following paragraphs.

The second type of graphics memory is called Display List Memory. This memory is not the same as screen memory (Display Page 1 or Display Page 2). The Display List Memory is used to store graphics images in their vector forms in a more permanent way so they can be manipulated with the Pan and Zoom functions. This storage is not automatic and must be specifically selected as the Data Logging function from the Graphics Setup Menu. The Data Logging of a graphics image means that the image is stored in its original format (as it was received from the host computer or keyboard) so it can always be redrawn by the terminal after a Zoom, Pan, or other transformation.

#### Data Logging

The following example gives some practical hints on using the Data Logging function and storing graphic data in Display List memory. Try this simple procedure:

Enter graphics mode	(use the <u>Text Graph</u> key)
Enter Setup Mode	(use the <u>Setup</u> key)
Enter Local Mode	(for this example)
Enter Setup Mode Graphics Menu	
Select a Display List	(List 1 is fine)
Turn Data Logging On	(check the Data Logging line)
Exit Setup Mode	(use the <u>Setup</u> key)



At this point you can create a graphics image. For instance,

```

type:      CTRL J          (enters vector mode)
then      , f Sp @        (locates cursor at left edge, middle of screen)
          CTRL _          (enters alpha mode)
Type:     This is a test  (enters alpha text)

Then enter: CTRL J        (enter vector mode)
           , f 0 @        (these coordinates
           5 k 5 K        draw a right
           , f 5 K        triangle on the
           , f 0 @        graphics screen)
    
```

Now enter Setup Mode again to turn Off data logging, then exit Setup Mode.

This simple graphics image is stored in Display List 1. You can now use Zoom and Pan commands to view the image in different conformations. Note that as you Zoom the image and then draw the zoomed image the alpha characters maintain their original size, though their location is changed as the zoom function required. This is discussed in detail later in this chapter.

This example is very simple. It intended to show you how data logging worked with a Display List. More commonly, data logging will be used with graphic data originating from a graphics application program running on a host computer. In this case the operation is just the same except the data would be sent by the application program with one of its commands (something like "draw:filename"). This could also be done with command sequences to start and stop data logging placed at the beginning and end of the graphics file. The key *Insert Here* can be used to control Data Logging. The *Shift Insert Here* key toggles the Data Logging setting immediately and the unshifted *Insert Here* key toggles Data Logging after a Clear Screen command (ESC CTRL L).

When the screen is cleared, or new images are drawn, the currently selected Display List is used to store the data. Any one of the four lists can be used, but they must be selected explicitly. An image must be stored in the Display List in order to use the Zoom and Pan operations on it. If other images are stored in other Display Lists, you can switch from List to List by simply pressing keys 1 through 4 and the new image will be drawn on the screen.

### Display List Memory Size

The size of the Display List Memory is dependent on the hardware configuration of the circuit board in your terminal - up to 512K bytes of memory are available. The actual size of the Display List Memory available is also dependent on the use of a printer buffer. Some of the Display List Memory may be allocated for the use of a printer buffer. Refer to the Graphics Setup Menu Printer Buffer line to select whether you want to use a Printer Buffer and the amount of memory you want to assign to it.

The Display List memory is assigned as needed for any particular list from the entire amount available. The memory could be allocated to contain two large and two small lists, or even one very large one and three small ones, with no problem. When the memory does reach its capacity, the terminal bell sounds.

### Graphics Quadrant Mode

The Graphics Quadrants line in the Graphics Setup Menu allows you to divide the graphics screen into quadrants, four sections arranged as shown in the following drawing.

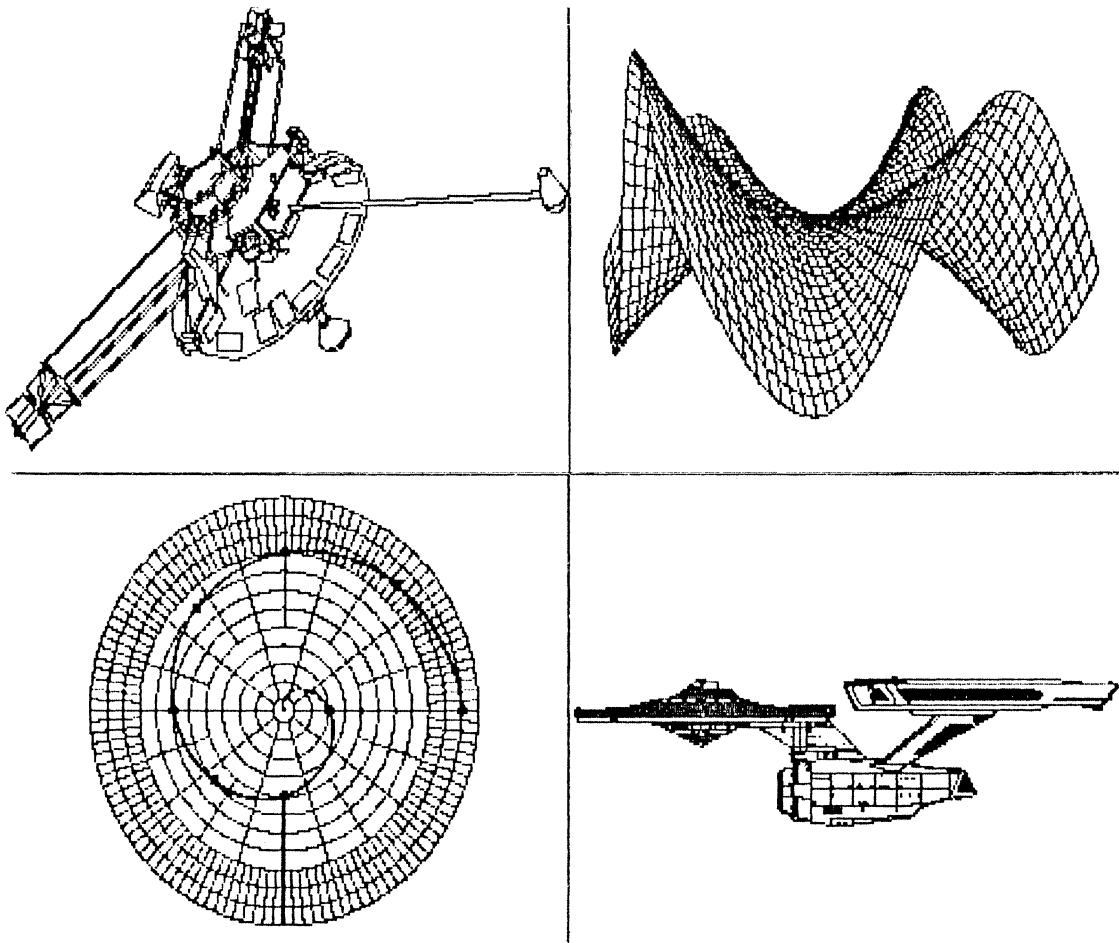

Graphics quadrant mode is a shorthand way to display the images stored in the four Display Lists at the same time. Each quadrant is a separate portion of Display List Memory and receives the contents of a Display List, 1 to 4, that is, an entire graphics image temporarily scaled to fit into the quadrant dimension. The four graphics quadrants can display their contents on the screen simultaneously. To do this simply select Graphics Quadrant Mode and each of the four Display Lists appear on the screen. These images are displayed by the terminal using internal Pan and Zoom operations to display them. Entering Graphics Quadrant Mode executes four automatic redrawings of the Display Lists.

You can use each of the Display List images individually by calling them up one at a time and then using Pan and Zoom controls to position and enlarge the image as needed. The Display Lists are numbered 1 through 4 in counter-clockwise sequence starting from the lower left corner.

**The 4096 Grid Of Logical Memory**

To understand the operation of the Zoom and Pan functions, and the scaling and clipping operations that they are based on, you should understand the way the terminal stores and displays the graphics images it receives.

The terminal receives a graphics image as a series of vectors, or vector addresses, typically in a format using a grid of 1024 or 4096 address points. The terminal puts these addresses in its graphics memory, which can be thought of as a grid of 4096 x 4096 address points, each on or off or the beginning or end point of a vector. The contents of this 4096 grid of memory is the stored graphics image.

When the contents of this logical address space are displayed on the screen by the terminal some adjustments have to be made since the screen has an effective address space of 1024 x 780 pixels. Two factors have to change for the image to be displayed: the resolution of the grid changes from 4096 to 1024 and the area changes from a square (4096 x 4096) to a rectangle (1024 x 780). These two changes are handled by the scaling and clipping operations.

Scaling means that an address is multiplied by an enlarging or reducing factor to fit a different size grid. If your zoom factor were 10, for instance, the 4096 grid with 4,096 points would be expanded to 40,960 points. Of course, when that enlarged grid was displayed on the screen of 1024 points, a large number of the points would not be displayed.

Clipping means that areas not shown on the screen are discarded or not plotted. When an image is scaled and then drawn, or redrawn, the entire address space is plotted, so there is always a good deal of clipping involved. There are thus two types of clipping: the first clipping occurs because the screen dimension (1024 x 780) is not square like the grid dimension so the top addresses (Y values between 781 and 1024) are always clipped; the second kind of clipping occurs when the scaled image of the grid is larger than the screen size, so points outside the specified Zoom or Pan box are not plotted or clipped.

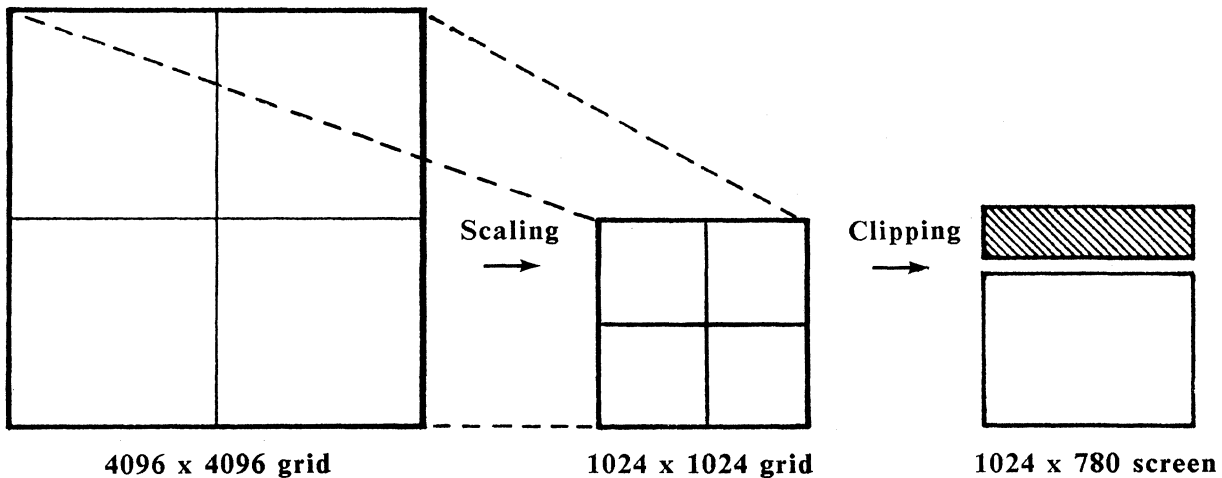

## HDS3200 Owner's Manual

For instance, suppose you had set a zoom factor of 4. That means that a pixel at address point 256 on the 1024 grid is scaled (multiplied by 4) and plotted to correspond to a screen point at 1024 (the right edge of the screen). A pixel at address point 255 would be plotted at screen point 1020. This is an effective magnification of four times for the image. The contents of the first 1/4 of the original 1024 grid (x = 1 to 256) are now enlarged to fill the entire screen up to point 1024. Obviously any points greater than 256 on the original will appear off the screen after the scaling operation. When they are not displayed because they fall outside the screen boundary, they are "clipped".

The concepts of scaling and clipping, which describe the relation between the logical storage of an image and its projection on the screen, help the understanding of functions such as Pan and Zoom.

### The Zoom And Pan Functions

The Zoom function is an operation that allows the user to set the scaling factor when an image is drawn on the screen. The Zoom function is simply the process of multiplying the contents of the logical memory by the user-specified Zoom factor to enlarge or reduce the area of the image which appears on the screen. Suppose you entered Zoom Definition Mode and set the Zoom factor to be 10. This would mean that the 4096 grid points would be scaled up by a factor of 10 before they would be displayed on the screen. Anisotropic zoom functions work the same way, with different scaling factors for the X and the Y directions.

The Pan function is an operation that allows the user to set the borders of the screen that will be clipped or displayed. The Pan function is similar in that a viewing area is defined for the 4096 grid, and then this viewing area is translated across it.

### Graphics Status Line

Pressing the *Status*, or *Shift Setup* key, displays a Status Line at the bottom of the screen, and if you are in Graphics Mode, this Status Line displays information about the current graphics configuration. The data on the Status Line refers to advanced graphics features available on the HDS3200 Model 30. If those features are not available on the terminal you have, the Graphics Status Line appears, but the values on it will be default values only.

The Graphics Status Line is:

```
List 1* Off Zoom 1/16* 512K Source (xxxx,yyyy) Dest. (xxxx,yyyy,xxxx,yyyy)
```

These fields contain data and concepts related to graphics functions normally controlled by escape sequence commands and other program controls. These graphics features are discussed in detail in the *HDS3200 Programmer's Reference Manual* and are presented here as simple definitions without discussion of the means to control them.

The first field gives the number of the Display List currently selected. If the number has an \* beside it, that means that the number of the display factors set is not the same as the Display List number. The display factors set is the list of parameters associated with a Display List that controls its display, such as

the current cursor position, the current line type, etc. Normally each Display List has and retains its own set of display factors, but it is possible to assign a set of factors from one Display List to another. When this happens the situation is reported on the Graphics Status Line with an \* in this position.

The second field shows whether Data Logging for the current Display List is On or Off.

The next field shows the X zoom factor, with values ranging from 1 to 16 and 1 to 1/16. The \* appears in this case if an anisotropic zoom is selected, that is, if the Y zoom factor is not the same as the X zoom factor.

This field gives the Display List memory hardware configuration of the terminal. The options are None for Models 10 and 20, and either 256K or 512K of memory for Model 30 terminals.

The next two fields give the coordinates of the source origin (X,Y values in the 0 - 1023 range), and the destination rectangle (whose origin point X,Y is between 0 - 1023; and whose delta X,Y values are between 1 - 1023 and 1 - 796). The source origin of (0,0) reflects no panning of the image. Panning is registered by the increasing of the source origin values up to a maximum of 1024, which would correspond to the right or top edges of the screen.

The destination rectangle is the area on the screen (0 - 1023, 0 - 795) where the image is displayed. The origin point of the destination rectangle is its lower left corner. The size of the rectangle is given by its delta X,Y. For instance, a destination rectangle of (512, 395, 512, 395) would be displayed in the upper right quadrant of the screen.

The concepts of source origin and destination rectangle are central to the understanding of Zoom and Pan operations, especially as these operations are used under program control. Generally, the ratio of the destination rectangle size relative to the size of the entire screen gives the zoom factor, and the displacement of the destination rectangle origin from the source origin gives the pan direction and amount. These concepts are discussed fully in the *HDS3200 Programmer's Reference Manual*.

### **Some Additional Graphics Considerations**

There are some additional things to consider with the concept of the 4096 grid. The first is the method used to store the image in the grid (data logging), whether the image is stored as individual points or as vectors. If the image was stored initially as points, when the image is zoomed the locations of the points would be zoomed in the same aspect ratio, but they would remain as individual points. If, on the other hand, the image was stored as vectors, the vector end points would be zoomed just as the points were, but the lines would be continuous between the points. For small scaling factors, these differences may not be apparent, but the difference in operation of the memory and scaling functions is considerable.

For example, suppose you constructed two circles, one by means of many short vectors, and the other by plotting individual points. At normal display resolution, these circles appear to be identical, but at larger Zoom factors their appearance is very different. At high magnification the circle made with

vectors is still a closed polygon, while the circle with individual points is now an enlarged image of unconnected points in a circular pattern.

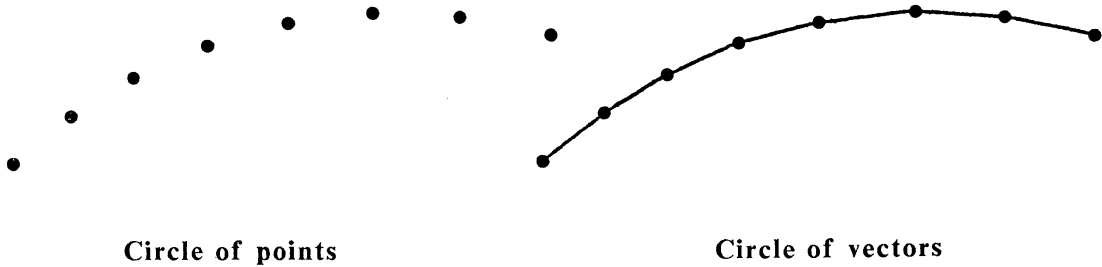

A similar qualification occurs when operating with Zoom and Pan functions in graphics alpha mode. In this case the location (the left baseline point of the alpha character cell) of the alpha character is scaled according to the zoom factor, but the actual alpha character displayed on the screen remains the size of the original alpha character. This is also the case with other graphics primitives, such as dotted and dashed line types, etc. The vectors are scaled correctly, but the line type patterns are unchanged. That is, the vector end points are zoomed to the appropriate scaling factor, but the line between is displayed with normal (not stretched or compressed) line type patterns.

**Graphics, Alpha mode**

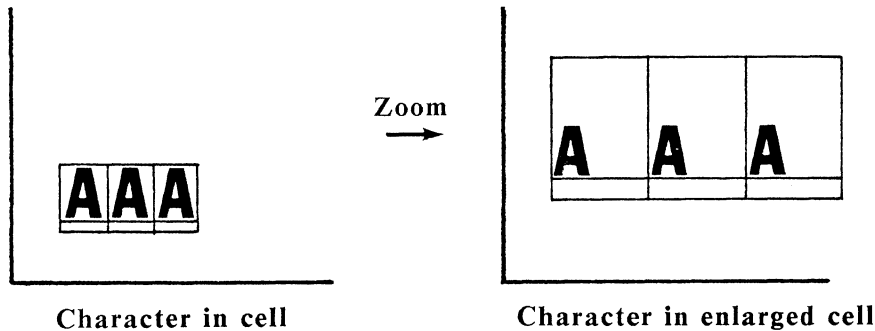

You are sometimes offered the choice between "hardware" and "software" characters when working with a graphics application program. These terms are used to designate the two options just discussed, whether the character is composed of bit mapped pixels (the hardware option) or of vectors (the software option). If you intend to use any of the Pan and Zoom functions on these images, you should choose the vector, or Software, option.

## HDS3200 Owner's Manual

Some terminal manufacturers use the word Zoom to mean pixel enlargement, in which the scaled image is simply the selected part of the original image with enlarged pixels. This gives a view of the screen segment in a larger size, but with no additional detail or resolution of the graphic image. On the other hand, the HDS3200 terminal uses a true enlargement according to the zoom factor selected, in which Zoom means that points or vectors are magnified, but vectors are still only one pixel wide. For instance, if two vectors in the original image were too close together to be resolved into separate pixels, increasing the zoom factor will separate them into individual lines.

## Chapter 10

### **Multiple Computer Applications**

#### *SUMMARY Multiple Computer Applications*

*This chapter describes advanced applications of the HDS3200 terminal including multiple computer networking, windows, and screen line display.*

The material presented in this chapter utilizes advanced capabilities of the HDS3200 terminal. It is not necessary to understand or use this material to operate the terminal effectively, though the techniques described here can be powerful tools in some situations.

#### **Multiple Computer Applications**

Many people use more than one computer in the course of their job. Sometimes one computer is your principal tool and another computer an infrequent source of particular data; other times you're deeply involved with several machines. Most terminals allow connections to only one computer at a time, and as a result many people who use more than one computer use more than one terminal to do it.

The HDS3200 terminal has been designed to connect to more than one computer at the same time. The terminal has two (optionally three) communications ports that allow you to connect to two (optionally three) computers at the same time. Since these ports are completely independent of each other, they offer maximum flexibility for your communications parameters with each computer. Each port has an individual Communications Menu in Setup Mode.

Several more features of the HDS3200 terminal make the operation of multiple computers easy and powerful. These features include additional pages of memory, the capability of creating windows, the ability to assign screen lines to each of the windows for display, and three independent sets of User Defined Keys. These powerful tools integrate multiple computer applications smoothly on a single terminal. These features can involve settings and definitions that are a little complicated, so follow the examples in this chapter carefully. Plan your own multiple computer application on paper so you can check everything before you start entering definitions.

#### **Multiple Computer Connections**

Each communications port of the HDS3200 is functionally independent with its own Communications Setup Menu, configuration, and protocol. Each port can connect a host computer to the terminal. The first line on the HDS Extensions Setup Menu, called Host Computer is on Port, allows you to select which of the Ports (and computers) is shown on the screen. This is called the main, or host, port.

The first step is to connect each computer to one of the three communications ports separately and verify that communications is operating correctly for each computer. Follow the instructions on communications contained in Chapter 3 of



## HDS3200 Owner's Manual

this manual. Select each computer as the host port in turn, test its communications, and then select the next one.

In this configuration, three computers on three ports, you have to put communications to one computer in the background to get access to another one. In some applications that is sufficient, but the HDS3200 terminal offers more powerful techniques that make another arrangement more convenient.

### Display Memory And Windows

The data and characters from the keyboard and the host that are written on the screen are stored in the display memory of the terminal. The HDS3200 terminal has 96 lines of memory available for its screen display. These lines of memory can be partitioned into segments, which are called windows. These windows are simply parts of the display memory that are defined as separate, distinct units.

The HDS Extensions Setup Menu shown below has several fields which allow you to define windows.

```

HDS3200-30 Setup Mode - Version 0.0
To Choose      Use
. Setup menus  . Editing keys,Do,Help
. Next fields  . Up or down arrow keys
. Next values  . Left or right arrow keys
  
```

Graphics	HDS Extensions	
General	User Prefer.	Communi- cation
User Defn Key	Keyboard	Next Menu

```

> Host Computer is on Port.....1.....>
  Select Current Window          1

  Define Window
  - memory lines                 001 to 024
  - memory columns               001 to 080
  Displayed on Screen Lines      001 to 024

  Cursor always visible          Yes
  Reset all Windows to Default
  Window video                   Normal

  Options: 1; 2; 3
  Replace      Ready              Ready              Ready              1
  
```

The second line selects the Current Window. The terminal can have up to six windows at one time. The next lines set the line and column definitions for the Current Window. Enter the number for the Current Window, then move to the next field. Press the right or left arrow key to edit the window definition. Enter the numbers for the window definition and press Enter to complete the definition. If the numbers for the default values are what you want (for instance for the column definitions), you can leave them unchanged.

Normally windows are taken as memory segments "one page" long, which is 24 lines of memory, either 80 or 132 columns wide. The default values are 1 to 24 for lines and 1 to 80 or 132 for columns, so you won't have to enter anything unless you want a different definition. This is the DEC VT220 factory setting, a one

page terminal. If you want to use a larger window, set the window as lines 1 to 96 (four pages). For normal terminal operation this allows you to enter much more text on the terminal and scroll up and down the 96 lines as you wish.

Entering window definitions is simple enough, you just have to remember to select an individual window number for each definition and to partition the display memory so the windows don't overlap. What the definition means is that the current host uses the current window assigned as its display memory, and uses only that memory for its communication with the terminal. All addressing is then relative to the currently defined window.

If you were running more than one application program on a computer, you might want to use a multiple window configuration. You would define the windows as you wanted, for example, window 1 as lines 1 to 24 and window 2 as lines 25 to 48 (this is the default assignment). This means each window is a single page and both are assigned to the Host computer on Port 1. When the Current Window is selected as Window 1, everything operates normally. The data from the keyboard and from the host are displayed on the screen. When you go into Setup Mode and switch the Current Window to Window 2, again all appears to operate normally except the new screen is blank. The data from the keyboard and the host are displayed on the screen, but the text from the previous session (window 1) is still held in memory lines 1 to 24, while this session is using the blank lines of memory 25 to 48. If you switch back to Window 1, the text from Window 1 is still there.

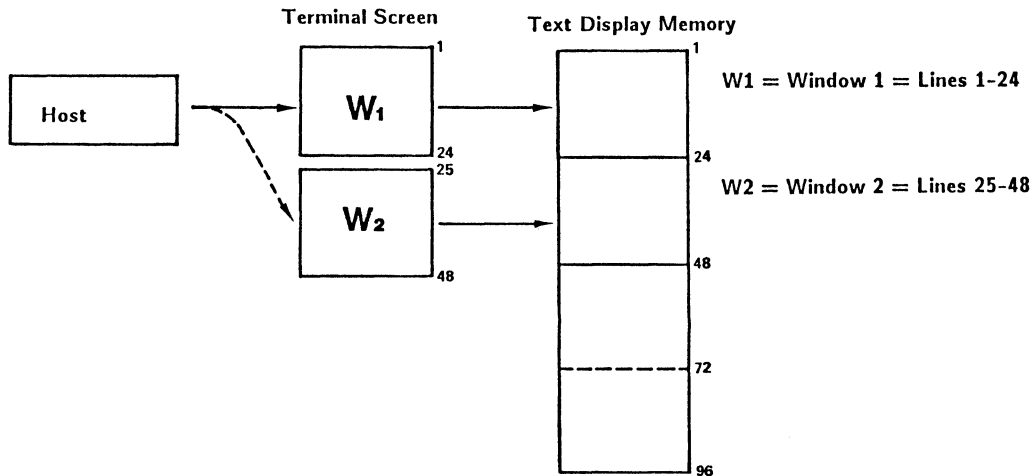

**In Setup Mode, HDS Extensions Menu:**

Select Host Computer On Port	1
Select Current Window	1
Define Window	
memory lines	001 to 024
memory columns	001 to 080

Select Host Computer On Port	1
Select Current Window	2
Define Window	
memory lines	025 to 048
memory columns	001 to 080

These two windows are separate parts of display memory. They are individually defined regions for scrolling, cursor movement, and video presentation. The Screen Video field on the HDS Extensions Setup Menu is for the normal or reverse video presentation of each window. This is defined for each individual window as it is selected. This display setting is also affected by the Screen Video selection on the User Preference Setup Menu, which is a terminal wide setting.

**Multiple Computers And Multiple Windows**

Suppose you are connected to two computers, one on Port 1 and the other on Port 2. In this case you could select host computer 1 on Port 1, then define Window 1 as lines 1 to 24. Then select host computer 2 on Port 2 and define Window 2 as lines 25 to 48 (the default configuration). This configuration links the windows to the different hosts and Ports. This means that data from Host 1 goes to Window 1 and data from Host 2 goes to Window 2. The windows are displayed on the screen when their respective hosts are selected from the Setup Menu.

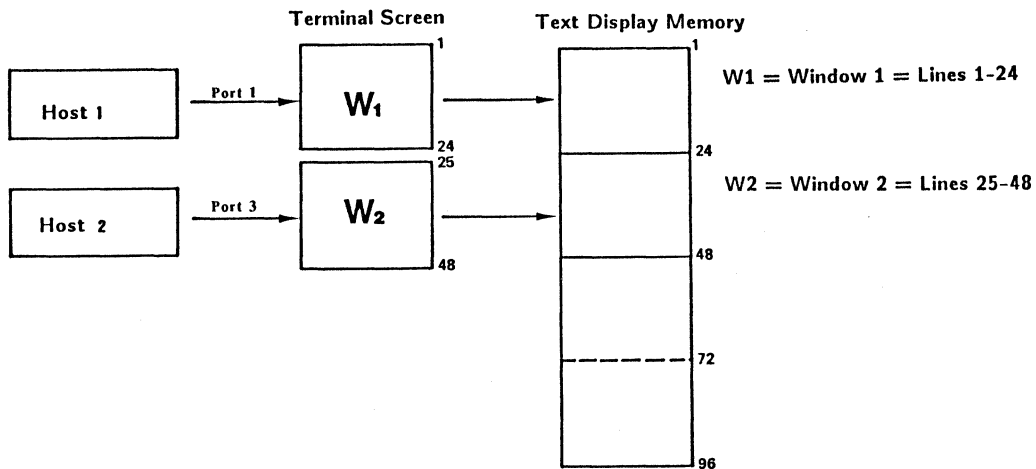

**In Setup Mode, HDS Extensions Menu:**

- Select Host Computer On Port 1
- Select Current Window 1
- Define Window
  - memory lines 001 to 024
  - memory columns 001 to 080
  
- Select Host Computer On Port 2
- Select Current Window 2
- Define Window
  - memory lines 025 to 048
  - memory columns 001 to 080

When you switch from one to the other (by switching the Host on Port field), you can interact with each host completely independently. Each host presents a 24 line segment of memory to the screen. The keyboard sends data to the port and window currently selected. Notice that switching from one host to the other

automatically switches the current window because the window assignment is linked to the host computer selection. Activity from each computer is registered in its own window, even if that window is not currently being displayed. When the window is displayed, all the data is present and unchanged.

**Simultaneous Display On The Screen**

A further feature of the HDS3200 terminal allows you to display parts of different windows on the screen at the same time. In this example, you could display part of Window 1 and part of Window 2 on the screen at the same time. This would allow you to monitor the activity of the two computers simultaneously.

The Displayed on Screen Lines field on the HDS Extensions Setup Menu selects the lines of the screen, from 1 to 25 (or from 1 to 50 for 50-line mode), that will be used to display the Current Window selected. This selection partitions the screen into different viewing areas for different windows. In this example, with Window 1 and Window 2 each defined as one page, you could assign screen lines 1 to 12 for Window 1 and screen lines 14 to 25 for Window 2. Note that this allows a one line separation between the two viewing areas and that it uses all 25 lines of the screen. The separation is convenient but not necessary. It is very important that your screen line definitions not overlap each other.

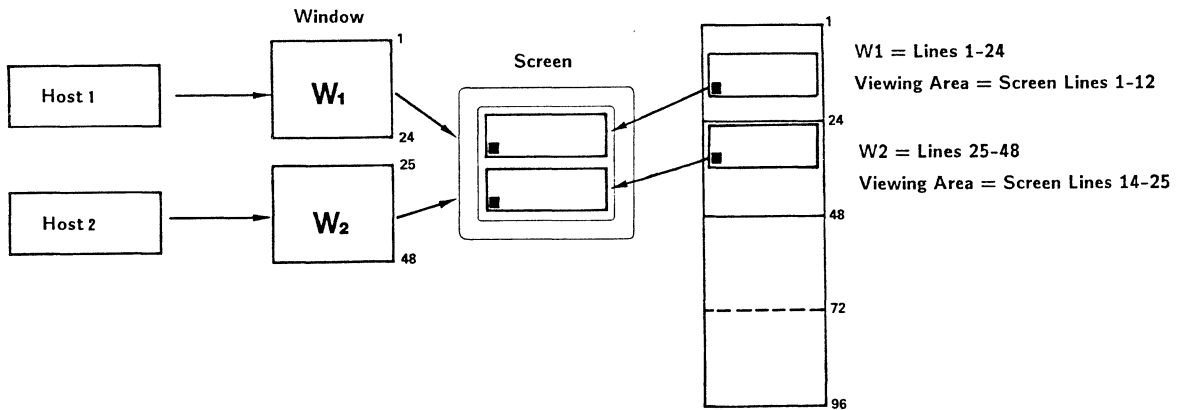

**In Setup Mode, HDS Extensions Menu:**

- Select Host Computer On Port 1
- Select Current Window 1
- Define Window
  - memory lines 001 to 024
  - memory columns 001 to 080
  - Displayed On Screen Lines 001 to 012
  
- Select Host Computer On Port 2
- Select Current Window 2
- Define Window
  - memory lines 025 to 048
  - memory columns 001 to 080
  - Displayed On Screen Lines 014 to 025

In this configuration each system has a host, a separate display memory, and a separate screen; each thus acts like a complete terminal (this is often called a "pseudo terminal" or "virtual terminal"). You can interact with one host or the other by selecting the Host Computer Is On Port field. This connects the keyboard to that device and automatically selects the window and other settings associated with that host.

Since the two windows each have 24 lines of data to be displayed in the 12 line viewing area, a selection must be made to choose which lines of data are displayed. The field labeled Cursor Always Visible selects which lines of the window are displayed. The Yes option, the cursor is always visible, means that the lines of data in the window are scrolled in the viewing area so the cursor, which appears on the screen line of most recent interaction with the host or program, is always visible. The No option displays the top lines of the window in the viewing area regardless of where the cursor is currently located. The cursor movement keys allow you to move around in the currently selected window and scrolling of the 12 line viewing area on the 24 line window lets you see the entire display.

If you want to see the entire window (as defined by this example), you could switch to 50-line mode (if your terminal has this option) by going to the second field of the User Preference Setup Menu and then redefining the Displayed on Screen Lines fields for both Window 1 and Window 2. This configuration would allow you to put both full-size windows on the screen at the same time. You would still need to switch back and forth between them by selecting the Host Computer Port field in order to select which system your keyboard input was connected to.

These features are powerful tools, but obviously require planning and careful definitions. The system is simple and can easily be expanded to include a third computer, with additional windows and viewing areas.

The examples of terminal configurations discussed here are constructed using the fields available in Setup Mode, which is consistent with the scope of this *HDS3200 Owner's Manual*. There are a number of escape sequences which can accomplish these commands and even more elaborate configurations; these commands are described in the *HDS3200 Programmer's Reference Manual*.

### User Defined Keys And Multiple Computer Applications

There are three sets of User Defined Keys available on the HDS3200 terminal. These sets are independent of each other and are designed for situations that use multiple computers or multiple windows with different requirements.

The most convenient way to use User Defined Keys in a multiple computer environment is to give them definitions that select the computer or window configuration you want. This requires that the definitions use escape sequence commands to change the configuration instead of Setup Mode fields. Since this manual doesn't discuss escape sequences or how to use them, read the following example carefully, or refer to the *HDS3200 Programmer's Reference Manual*. The escape sequences required are found in the Quick Reference Guide at the back of this manual. Be careful with these escape sequences and the order that they are executed.

### Programming Three Function Key Sets

With a terminal configuration for multiple computers the complexity of interaction increases dramatically. The three sets of User Defined Keys help meet this problem by making individual, independent sets of keys available for definition in each environment. It is suggested that the same three keys be allocated in all three sets of definitions to execute the commands to select hosts 1, 2, and 3. In this way the same three keys will always be available for switching from system to system without having to guess which set of function keys is currently active. Each set of keys can then have individual keys programmed for login sequences, insert mode commands, etc. It is easier to remember if these similar functions are located on the same keys in each set even though the definitions to execute them might be different.

Each set of User Defined Keys has 21 keys, shifted and unshifted, available for 42 definitions. These definitions can be for RAM or NVM, and the total number of approximately 1400 characters available applies to the keys in all the sets.

Follow this example for programming two function keys to switch from host 1 to host 2. This example uses escape sequences programmed onto the function keys instead of using Setup Mode. If you don't know about using escape sequences for terminal commands, just follow this example closely and type the sequences exactly as they appear.

First, you must go to the User Defined Key Setup Menu and select the field for the terminal to use 3 sets of UDKs. Next you must assign the first set of UDKs to host 1 and the second set to host 2. You can do this easily by going to the HDS Extensions Setup Menu to select Host 1, then going to the User Defined Keys Setup Menu to select UDK set 1, then back to select Host 2, and then UDK set 2. Once these assignments are made, the connections are made automatically whenever the Host Port is selected. Try switching from host to host to check that the UDK assignment changes correctly.

Now you are ready to program the keys to switch hosts for you. Select keys that are convenient but not likely to be pressed inadvertently, like Shift F6 and Shift F7. Go into the User Defined Keys Setup Menu, select an NVM definition, and press Shift F6 to begin the definition. The definition is the escape sequence to set the host port. Type CMD [ 1 / q. CMD is Shift ESC. Don't type the spaces between the characters or the period at the end. Exit the Shift F6 definition. Now do the same with Shift F7, entering the definition CMD [ 2 / q. These two definitions select hosts 1 and 2.

Now you must enter the same definitions for the same keys in UDK set 2. You can switch to UDK set 2 either by switching the Host Port, or by selecting set 2 from the UDK Setup Menu. You'll notice that Shift F6 and Shift F7 in UDK set 2 are undefined. Give them the same definitions as in UDK set 1.

At this point, the two keys are programmed to select Host 1 or Host 2 whenever you press them. Associated selections, such as the windows used by that host, the screen lines, the video display, the User Defined Key sets, etc. are all made automatically when the host is selected. As long as you keep your definitions clear and complete, you won't have any problems.

### Other Considerations

These multiple terminal configurations are very useful for complicated installations, and save desk space at the same time they are giving additional convenience and control. It is possible to use these configurations for other tasks, like file transfers between computers, on-line monitoring, etc. but these are sophisticated operations and should only be attempted by experienced users with the assistance of the *HDS3200 Programmer's Reference Manual*.

The last HDS Extensions Setup Menu field, Reset All Windows to Default, will cancel all definitions for windows. If you get your definitions mixed up and don't know where the problem lies, this is the way to reset the window definitions. The actual definitions of the default windows depend on the selection of 25 or 50 line mode operation.

The examples described in this chapter dealt with relatively simple interactions between the host computer and the terminal. The host used one window in the terminal's memory. In more complicated interactions the host sometimes tries to use more than one window, defining its own partitions, etc. These interactions can lead to conflicting definitions and usually require an experienced hand in designing a configuration of windows and memory lines that meets these more complex needs. The *HDS3200 Programmer's Reference Manual* has additional discussion and examples for situations of this type.

## Chapter 11

### Terminal Maintenance

#### *SUMMARY Terminal Maintenance*

*This chapter describes some simple procedures and precautions you should take with your terminal, including basic housekeeping. It also describes the self test features of the terminal and some simple troubleshooting if you have a problem. Since there are no user-servicable parts on the terminal, these diagnostic tests are oriented to the user and do not require any technical experience.*

#### **Maintaining The Terminal**

The HDS3200 Terminal is designed to be free of any service requirements for its lifetime, although periodic cleaning and reasonable care are recommended.

Unplug the terminal whenever you clean it. Use a damp, not wet, cloth to clean the case, with a mild soap if needed. Make sure the terminal is completely dry before you plug it in again. Do not use abrasive or chemical cleaners, waxes, or polishes. A vacuum cleaner or soft brush is most effective in cleaning the keyboard. A non-static cloth will remove dust from the display screen.

A section of Chapter 7, *HDS Mouse*, gives instructions on removing and cleaning the ball of the mouse.

Adequate ventilation is important for the terminal, so be careful not to block the flow of air around the terminal, particularly the monitor housing and the base.

#### **Troubleshooting Terminal Problems**

This troubleshooting guide can only give the most general suggestions about meeting problems you might have with your terminal. First, try to figure out if the problem is caused by the hardware (the terminal itself won't turn on, the screen is dark, the memory fails, etc.) or by software (some programs create gibberish characters, sometimes you can't get a good printout, etc.). Often this is not a clear cut choice.

If you have an obvious hardware problem, such as not turning on, or no monitor screen activity, you can try a few simple things but remember that there are no parts of the terminal which can be repaired by the user, so do not open the terminal case unless you are an authorized service technician. There are high voltages in the terminal which can be dangerous, and many parts which can be easily damaged. Opening the terminal case will void the warranty on the terminal.

If you have a problem with the terminal, first check that the power cord is securely connected, and that there is power coming to the terminal. Always use the power cable in a properly grounded outlet.



## HDS3200 Owner's Manual

There is a fuse next to the power cord receptacle on the terminal. Check the fuse, and replace it if necessary. Use a SLOW BLOW 250 V, 2 A, Type T fuse. The terminal uses a 1/4 x 1 1/4" (6.3 x 32 mm) fuse.

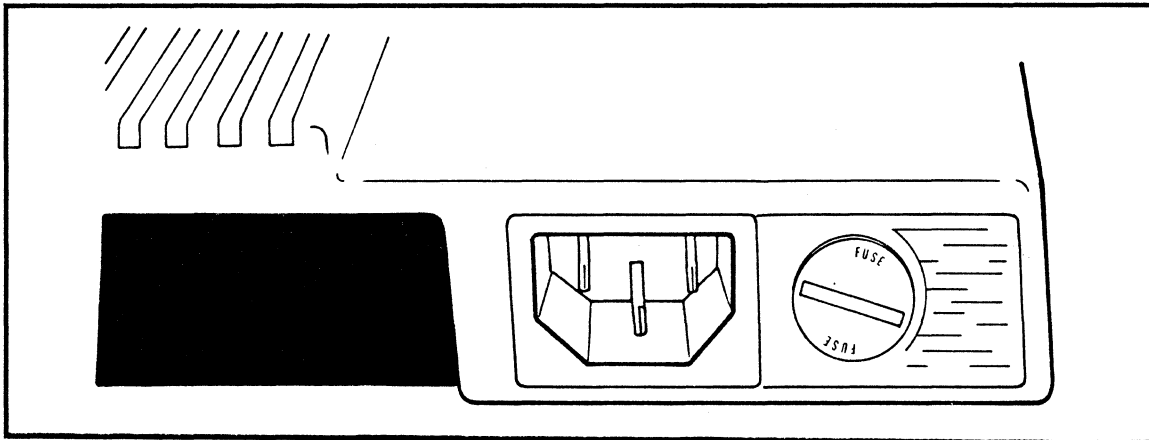

If there is power coming to the terminal, the power LED on the keyboard should light up and the terminal should beep when you turn the terminal On. If it doesn't turn On and beep, there is a power problem, either in the external source or the internal power supply. The internal power problem can be repaired only by a qualified technician.

The beep after turning On indicates that a memory test performed automatically by the terminal is complete. If you get the beep, but don't have anything on the screen, try adjusting the brightness of the display. Turning the brightness all the way up (clockwise), should produce a light screen with lines on it. This light screen should be present even if there is faulty logic or communication. If the screen remains dark, there is a power problem or a faulty monitor.

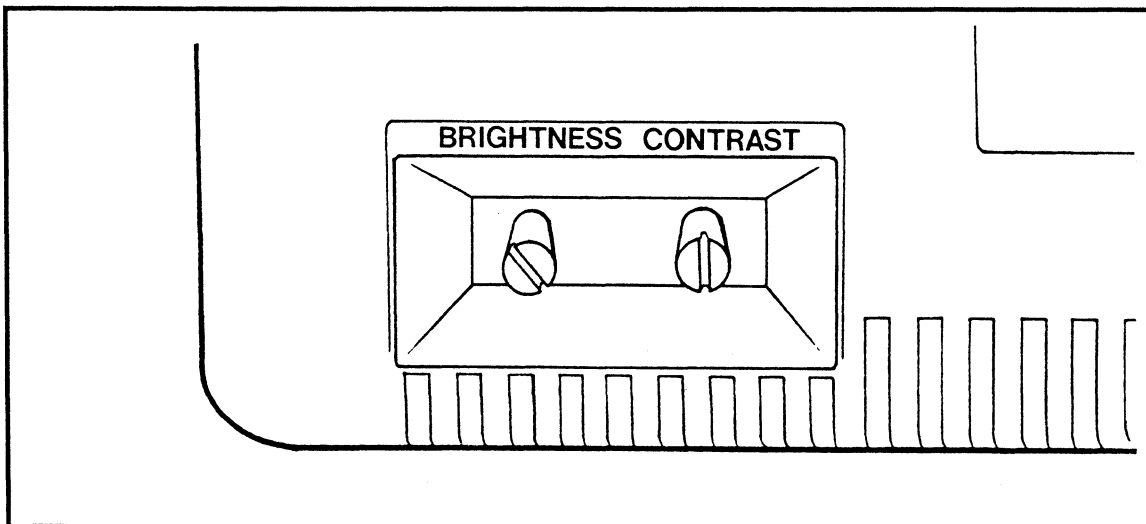

If the screen is functioning (shows the light screen with the brightness adjustment) but you don't get any other display, try to display the Setup screen. If it appears, that means the keyboard and internal logic are

functioning correctly. The Setup key and Setup Mode are always available on the terminal. If Setup Mode doesn't appear, try exchanging keyboards (if there is another HDS3200 terminal available) to narrow the problem to the keyboard or the logic board.

Use Setup Mode to choose the Local Mode setting on the General Setup Menu. The terminal should always work in Local Mode with Factory Default settings. If it doesn't work in Local Mode, try the memory tests described below to help narrow the problem, and consult an authorized service technician.

If the terminal operates correctly in Local Mode, the problem you see is probably in your communication with the host computer or with the configuration settings you had previously chosen. Be careful when you reconfigure the terminal for your host computer or operating environment. Some configuration settings may be in conflict and may be creating the problems you see.

Since the problem you're having may be related to incorrect communications settings or the configuration of the terminal, use the Reset NVM to Factory Defaults command in Setup Mode. This sets the terminal to a known state (remember to choose Local Mode again). You may want to record the settings you had made previously, both as a help in diagnosis of the problem, and as an aid in reconfiguring the terminal when you're finished with the test.

If the terminal seems to function in most ways, but still has intermittent problems with characters or display, the problem may be in the communications settings, which may have the wrong baud rate or data/parity bit settings, etc. Communications settings have far reaching consequences and cause many more problems than hardware. For troubleshooting suggestions for communications problems, refer to Chapter 3, *Setting Up Communications With The Computer*.

If none of these tests seems to isolate the problem, contact an authorized Human Designed Systems service center for help. If the problem seems to occur with a particular piece of software, or a particular device, contact the manufacturer to see what the requirements of the software or device are.

### Terminal Self Test Procedures

The terminal has several internal tests it can perform to help pinpoint a problem you may have. The results of these tests are displayed automatically on the screen. The tests analyze simple functions of the terminal and are not as diagnostic as the preceding material.

To use the commands, simply type in the characters in the command as they are shown. Remember to use Cmd (or Shift Esc), and to allow no spaces between characters in the command.

**Cmd [=0 y** performs a test of the terminal's memory, ROM (Read Only Memory which contains the terminal's operating firmware), RAM (Random Access Memory which is used for the display), and NVM (Non Volatile Memory which stores the terminal's configuration). This test gives a beep when completed and displays any error messages on the screen, as follows:

ROM 1 Error  
ROM 2 Error  
RAM Error  
NVM Error

This test is performed automatically each time you turn On the terminal.

**Esc [=1 y** performs a communications test. This test requires a loopback connector (any simple connection between pins 2 and 3, receive and transmit) on the main communication line. Since the Self Test command must be received from the communication line, not the keyboard, you must type Esc not Cmd for the command. In this test the terminal sends out the 96 displayable ASCII characters automatically. They are displayed on the screen twice, once as they are sent out, and once as they are received. The test response is:  
Communications Error.

**Cmd [=2 y** displays all the character sets present on the terminal.

**Cmd [=4 y** generates a graphics alignment pattern on the screen. This tests the graphics mode operation of the terminal and the general function, alignment, brightness, focus, etc. of the monitor.

**Cmd [=8 y** generates a full screen of E's, including the 25th line, as a test for the monitor and screen alignment.

## GLOSSARY

These are some commonly used terms that occur in this manual and in general usage around computers and terminals. These definitions are intended to satisfy a simple question but are not detailed enough to use as a technical reference. If you need more detailed discussion of these terms or concepts, consult the *HDS3200 Programmer's Reference Manual* or other computer lexicons.

**Alternate Processing Mode** Processing modes refer to commands that control the processing of some part of the terminal's operation. The processing modes differ from terminal commands because they have a Set and a Reset State and special groups of control procedures.

**Anisotropic Zoom Factor** A scaling factor in which the scaling factor in the X direction is not the same as the scaling factor in the Y direction.

**ANSI** American National Standards Institute. A convention which establishes the forms and procedures for computer and terminal commands and terminology. The HDS3200 Series terminals conform to the ANSI standard referred to as ANSI X3.64 (1979).

**Answerback Message** A message stored by the terminal sent to the host computer in response to a specific command.

**APL** A Programming Language. A special programming language which uses a special character set and overstrike characters.

**Application Mode** A designation of one setting of cursor or numeric keypad operation in which keys on the keypad send out special definitions.

**Application Program** A program running on a computer that handles a particular application, such as word processing, or graphic presentation.

**ASCII** American Standard Code for Information Interchange. A convention which designates the letters, numbers, symbols, and control codes on the keyboard as unique 7 and 8 bit binary numbers.

**Attributes** Properties of a character relating to the way it is displayed on the screen. Display attributes are also referred to as "graphic rendition". Display attributes are bold, reverse video, invisible, underline, and blinking.

**Auto Wrap** A processing mode in which a line of characters is automatically continued on the beginning of a new line when the previous line is filled. Auto Wrap treats the edges of the screen as if they were contiguous. For example, if the cursor were in the rightmost column of the screen, and a character was typed, the autowrap feature would move the cursor to the left end of the next line.

**Baud Rate** The rate of transmission of data on communication lines, given in bits per second.

**Bell** The sound made by the keyboard's speaker, often as a signal to notice something about the terminal.

**Blinking** A visual attribute of a character which turns the display of the character On and Off repeatedly.

**Break** A keyboard key which sends a command to interrupt the communication between the terminal and the other device.

**Calculator Mode** A local operating mode of the terminal that allows you to use the numeric keypad for mathematical calculations on the screen. The Comp Char Enter keys enter Calculator Mode.

**Character** A general term to designate a pattern (usually a letter or symbol) defined by a character set to correspond to an ASCII code.

**Character Set** A collection of dot patterns, commonly letters, numbers, or graphic designs, arranged in a chart to correspond to the ASCII code values. The character set selected by the user determines what is actually displayed for each ASCII code.

**Character Size** A character in this sense is merely the form of the ASCII code as either a 7 or 8 bit binary number used in communications. The 7 or 8 bit character size must be specified for correct communications between devices.

**Clipping** Truncating or cutting off those parts of the graphics image plotted in the terminal's logical memory that fit outside the terminal's 1056 x 800 pixel display.

**Cmd** A keyboard key, Shift Esc, that is used for commands that are specifically for the terminal (as distinct from commands originating from the host computer or the operating software). All local terminal commands use Cmd because it is not sent on the communications lines to the other devices connected to the terminal.

**Command (terminal)** A command which controls a function or operation of the terminal rather than the host computer or the operating software. Terminal commands use the Cmd key when given from the keyboard and Esc when originating from the communication lines.

**Command Sequence** A sequence of letters or numbers that make up a particular command. Some commands are a single keystroke, others are control codes, and others have several parameters or multiple entries for one parameter.

**Communications** The general term which describes the information interchange between two devices.

**Comp Char** A keyboard key which enters Compose Character Mode, a terminal operating mode which allows creation of international letters and symbols. This key is also used for Calculator and Zoom and Pan Definition Modes.

**Control (Ctrl)** A type of SHIFT key which produces control codes, which are ASCII codes that correspond to special non-printing characters often used as commands for the terminal or operating software. A control code, such as Ctrl A, is produced by holding down the Ctrl key while pressing the A key.

**Control Code** An ASCII code which has a special designation as a command. 7-bit control codes are produced on the keyboard by the *Ctrl* key with other keys. 8-bit control codes are produced on the keyboard by an equivalent escape sequence. These control codes correspond to characters that are not displayed (except in Transparent Mode) or printed.

**Control Code Processing** An operating mode of the terminal in which commands are displayed on the screen but not processed. This is useful in troubleshooting procedures to examine what commands and sequence of commands the terminal receives. Control Code Processing is selected in the General Setup Menu as the Display option of the Control Code Processing field.

**CTS Protocol** A means of controlling the transmission of data between two devices which uses the Clear To Send line of the connecting cable to start or stop transmission. This protocol depends on a correct physical connection of the cable as well as correct controlling of the signals on the CTS line.

**Current Loop Interface** A type of communications interface.

**Cursor (position)** The line and column on the screen where the next character entered will be displayed.

**Cursor Commands** Commands which control the cursor movement.

**Cursor Keys, Keypad** A group of keyboard keys. Normal Mode of the cursor keypad controls cursor movement. Application Mode uses the cursor keypad for different commands. Setup Mode uses the cursor keypad for choosing setup options.

**Data Bits** The seven (or eight) bits in the transmission that correspond to the character being transmitted. Only these seven (or eight) bits are treated as data. Other bits in the transmission are interpreted as parity bits, stop bits, or ignored.

**Data Logging** A phrase that describes the terminal's storing a graphics image in its graphics Display List.

**Data/Talk** This keyboard key is present on a DEC VT220 terminal and is used for control of an internal terminal modem. This function is not available on the HDS3200 series terminals and the key has been relabeled the *Text Graph* key.

**Data Terminal Ready (DTR)** A signal carried on one of the pins of the communications line that indicates the terminal is ready and connected. Pressing the *Shift Break* key lowers the DTR signal for 3 seconds and is used as a disconnect signal.

**Default** This is the value the terminal uses for a command or a setting when you don't make a specific choice. Default settings are usually the most common choices for any particular situation.

**Delete** A keyboard key, marked <X], which produces ASCII code 127, the (RUBOUT) character. This ASCII code is sometimes processed as a delete character, hence the key's name.

**Destination Rectangle** The rectangle of screen dimensions, defined by a destination origin and delta X,Y value, into which the graphics image is fit by means of scaling and clipping operations.

**Digitizer Tablet** A graphics input device that uses a stylus and a tablet on which the user can write points or lines as if writing on a page. HDS3200 Series terminals use the Summagraphics MM Series digitizer tablets.

**Display List** A designation of graphics memory which stores a graphics image. The HDS3200 terminal has four display lists, which can be up to 512 K bytes of memory.

**Display Memory** The terminal's memory assigned to store the data you enter and display on the screen. This memory accommodates 96 lines of 80 or 132 column text.

**Draw Function** A graphics function to draw the screen after a zoom or pan operation. Drawing is the application of new scaling and clipping factors to the image in graphics Display List memory.

**Duplex (Half/Full)** Half Duplex is often called Local Echo. Full Duplex is No Local Echo. These designate a processing mode of terminal communications in which keyboard data is sent to the host computer and to the screen (Half Duplex), or to the host computer only which in turn sends it back for display on the terminal's screen (Full Duplex).

**Echo** A reference to the sending back of data transmitted to a device. See Duplex (Half/Full).

**Editing** The handling or modifying of textual data, usually on the screen, involving cursor movement, inserting/deleting characters, etc.

**Enter** The keyboard key in the numeric pad which duplicates the Return key.

**Escape** A keyboard key which is used as the first character of many command sequences.

**Escape Sequences** Command sequences which begin with the Escape character.

**Factory Default** Terminal settings for the original factory configuration. Factory default settings are always available by executing the Reset NVM to Factory Defaults command in Setup Mode.

**Function Keys** See User Defined Keys.

**Graphics** An operating mode of graphics terminals that permits display of images defined by single screen points anywhere on the screen, instead of dot patterns defined by character sets within a grid of screen text blocks.

**Graphics Quadrants** A display mode which places all four display lists (with appropriate scaling factors) on the screen at the same time in a quadrant formation.

**Hold Scrn** A keyboard key which stops and starts the transmission of data to the screen. This key function operates independently of the XON/XOFF protocol. The LED on the *Hold Scrn* key indicates the screen display has been stopped, and will remain stopped until the key is pressed again.

**Host (Computer)** The computer to which the terminal is attached and which processes the terminal's data.

**Inverse Video** Normal screen display shows light characters on a dark screen. Inverse video shows dark characters on a light screen. Inverse video is often used for emphasis or highlighting.

**Keyboard** The collection of keys the terminal uses as a primary input device.

**Keyclick** The sound made when a key is depressed. The volume of the keyclick can be adjusted in Setup Mode.

**LED** Light Emitting Diode. A small indicator light used on the keyboard. The terminal uses LED's for the Power indicator and on the *Lock*, *Hold Scrn*, and *Comp Char* keys.

**Line (port, communication line)** A term designating the physical connection or the connecting point on the terminal, but generally meaning the device to which the line is connected and the communication activity on that line.

**Line Feed** The keyboard key which sends the command to move the cursor down one line in the same column.

**Local Mode** A processing mode of the terminal in which the communications lines are not used and all operations remain local to the terminal.

**Lock** A keyboard key which invokes the uppercase form selected by the Caps/Shift Lock option on the Keyboard Setup Menu. The Caps Lock option sets only alphabetic keys to uppercase values; the Shift Lock option sets all keys to their uppercase values.

**Memory** See Display Memory, NVM, RAM, and ROM.

**Mouse** A small hand-operated graphics input device used on a flat surface that registers its relative position and movement on the surface onto the screen. A mouse may use different (and selectable) tracking ratios for movements, that is, with a tracking ratio of 1:2 a movement of one inch by the mouse produces a two inch movement on the screen.

**Network** Connecting two or more devices to a terminal. Generally this means simultaneous operation and control of two or more host computers.

**New Line** A processing mode, set in Setup Mode, which changes the *Return* key's function to carriage return/line feed instead of carriage return alone.

**Next Line** A keyboard key (*up arrow*) which operates in Setup Mode. Pressing this key moves from one line to the next in Setup Mode.



**NVM Non Volatile Memory.** Memory used for reading or writing which is not dependent on the terminal's power to store its data. The terminal uses NVM for storing the configuration of Setup Mode, User Defined Key definitions, and other terminal configurations that you want to retain even when the terminal is turned OFF.

**Pan, Pan Definition Mode** The graphics capability to move around within a graphics image on the screen.

**Parity** A checking procedure to verify the accuracy of transmitted data. The terminal can be set to send parity information with data it transmits (No parity sent, Even, Odd, Mark, or Space parity). It can also be set to use parity checking on data it receives.

**Page Number** A designation of a 24 line part of display memory. The 96 line memory may be used as one unit, or may be divided into four blocks (each 24 lines = one page), which may be used as independent blocks of memory.

**Port** A term designating the physical connection or connecting point on the terminal for other communications lines, but generally meaning the communicating device on that line.

**Printer Buffer** The allocation of a portion of the graphics display list memory for a holding area, or buffer, for data going to the printer.

**Print Scrn** The keyboard key which sends the contents of the screen to the printer. *Ctrl Prnt Scrn* toggles Auto Print Mode On and Off for the printer.

**Processing Modes** See Alternate Processing Modes.

**Programmable Function Keys** See User Defined Keys.

**Protocol** A procedure or agreement in computer communications that governs the interchange of data between two devices.

**Quadrant Mode** See Graphics Quadrants.

**RAM Random Access Memory.** RAM memory used for reading or writing data. It is active only as long as the power is ON. The terminal uses RAM memory for the display memory.

**Recall Settings from NVM** A Setup Mode command which resets the terminal, clears memory, and uses the NVM settings for the terminal configuration. This is the same as the hard terminal reset command.

**Reset** A term in general use for commands which stop the terminal's processing activity and return the terminal to some known state.

**ROM Read Only Memory.** Memory used only for reading data. ROM is permanent storage and is not dependent on the terminal's power. The terminal uses ROM memory for its operating software.

**RS-232, RS-423 Interface** Designations for serial communications connectors that conform to EIA standards of signal level and configuration.

## HDS3200 Owner's Manual

**Save** A Setup Mode command stores the current configuration of the terminal in NVM (Non Volatile Memory).

**Scaling** A multiplication of the graphics image by a designated zoom factor (larger or smaller).

**Screen Range** The user-defined part of the screen where the current window contents are displayed.

**Scrolling** A screen movement to move the text up or down to view lines not currently displayed. Setup Mode allows you to choose jump or smooth scroll operation.

**Self Test** A command in which the terminal performs some simple diagnostic tests on its operations and displays the results on the screen.

**Setup, Setup Mode** An simple operating environment of the terminal which allows you to define the configuration of many of terminal settings and User Defined Key definitions. *also* The keyboard key you press to enter Setup Mode.

**Shift** Two keyboard keys used with other keys to produce uppercase alphabetic letters or the upper characters shown on the keytops.

**Source Origin** The origin (lower left corner point) of the source image. This is the point which defines panning translations (for instance, from point 0,0 to point a,b) on the logical graphics grid.

**Stop Bits** One (or two) marker signals included in data transmissions to mark the end of each character sent.

**Tab** A keyboard key which moves the cursor to a preset position on the screen.

**Terminal** A device to communicate with a computer, both as input (the keyboard), and as output (the screen, the printer port).

**Text Graph** This key switches from the terminal's text mode to alpha mode of graphics operation. *Shift Text Graph* switches back from graphics mode to text mode operation. *Ctrl Text Graph* switches from text mode to alpha mode of graphics operation and clears the graphics screen.

**Times 1 Function** A graphics function which returns the graphics image to its original form, regardless of the number or type of zoom and pan operations which had been done.

**Toggle** A type of switch where the same action successively produces opposite results. For example, pressing *Lock* once turns the Caps Lock function ON, pressing the key a second time turns the function OFF.

**Tracking Ratio** The selectable relationship of movement for a mouse and for the screen. A ratio of 1:2 indicates that a movement of one inch by the mouse produces a two inch movement on the screen.

## HDS3200 Owner's Manual

**User Defined Keys** 21 keyboard keys, *F6* to *F20* and six editing keys, either shifted or unshifted, as well as the mouse and digitizer keys, are called User Defined Keys because they can accept any definition, text or commands, the user assigns to them.

**Value** A keyboard key (*right* or *left arrow*) which operates in Setup Mode. This key moves from one value to the next through all the available choices for the selected field in the Setup Menu.

**VT100** The DEC terminal whose operation the HDS3200 series can emulate by choosing the appropriate Setup Mode selections.

**VT220** The DEC terminal whose operation the HDS3200 series terminals emulate.

**VT52** A DEC terminal which uses a set of commands that are not ANSI standard. The HDS3200 terminals can emulate VT52 terminals by choosing the appropriate Setup Mode selections.

**Window** A user definable partition of display memory that can be treated as a separate memory group. Windows are especially convenient in networking situations.

**XON/XOFF Protocol** A means of controlling the transmission of data between two devices that uses XON and XOFF characters (Ctrl Q and Ctrl S respectively) in the data stream to start and stop transmission.

**Zoom, Zoom Definition Mode** A graphics function which allows the enlargement or reduction of a graphics image.

## APPENDIX A

**Compose Mode Operation**

The HDS3200 terminal can use special compose sequences, created with the Comp Char key, to display characters that do not appear on the keyboard. These special characters are usually characters from the Multinational character set. They are displayed on the screen and printed as normal characters, provided the Printed Data Type field of the Port 2 Communications Setup Mode Menu is set to Multinational and the printer is capable of printing them.

Pressing the Comp Char key begins a special keyboard sequence to compose a character from two other characters. When this sequence is activated, the LED is On and normal key processing is temporarily suspended until the sequence is entered and the LED is turned Off. The two characters making up the special character are entered, and the special character is displayed on the screen if a valid character was created. If the special character entered was not valid, the bell rings and no character is displayed. If you accidentally press Comp Char, you can cancel the compose sequence by pressing the <X] (Delete) key.

The Comp Char key can be disabled in Setup Mode. If it is disabled the normal Compose Mode characters shown below cannot be generated from the keyboard. Other functions of the Comp Char key, such as in Calculator Mode or Zoom and Pan Definition Modes are unaffected by the disabling selection.

**Valid Compose Mode Characters**

These sequences must be entered in the correct order.

Name	Characters Entered	Result
Micro sign	/u	µ
Micro sign	/U	µ
1/4	14	¼
1/2	12	½
AE Ligature	AE	Æ
OE Ligature	OE	Œ
ae Ligature	ae	æ
oe Ligature	oe	œ

These sequences may be entered in any order, with any of the indicated characters.



## HDS3200 Owner's Manual

Copyright sign	©	©
	©	©
	©	©
	©	©
	©	©
	©	©
Feminine ordinal indicator	a <sub>~</sub>	ª
	A <sub>~</sub>	ª
Angle quotation mark left	<<	«
Degree sign	0 <sup>^</sup>	°
	*	°
Plus/minus sign	+ -	±
Superscript 2	2 <sup>^</sup>	²
Superscript 3	3 <sup>^</sup>	³
Paragraph sign	p!	¶
	P!	¶
Middle dot	. <sup>^</sup>	·
Superscript 1	1 <sup>^</sup>	¹
Masculine ordinal indicator	o <sub>~</sub>	º
	O <sub>~</sub>	º
Angle quotation mark right	>>	»
Inverted question mark	??	¿
A grave	A <sup>`</sup>	À
A acute	A <sup>'</sup>	Á
A circumflex	A <sup>^</sup>	Â
A tilde	A <sup>~</sup>	Ã
A umlaut	A <sup>"</sup>	Ä
A ring	A*	Å
C cedilla	C,	Ç
E grave	E <sup>`</sup>	È
E acute	E <sup>'</sup>	É
E circumflex	E <sup>^</sup>	Ê
E umlaut	E <sup>"</sup>	Ë

## HDS3200 Owner's Manual

I grave	I `	ì
I acute	I ´	í
I circumflex	I ^	î
I umlaut	I "	ï
N tilde	N ~	ñ
O grave	O `	ò
O acute	O ´	ó
O circumflex	O ^	ô
O tilde	O ~	õ
O umlaut	O "	ö
O slash	O /	ø
U grave	U `	ù
U acute	U ´	ú
U circumflex	U ^	û
U umlaut	U "	ü
Y umlaut	Y "	ÿ
German small sharp S	≡≡	ß
a grave	a `	à
a acute	a ´	á
a circumflex	a ^	â
a tilde	a ~	ã
a umlaut	a "	ä
a ring	a *	å
c cedilla	c ,	ç
e grave	e `	è
e acute	e ´	é
e circumflex	e ^	ê
e umlaut	e "	ë

## HDS3200 Owner's Manual

i grave	i `	ì
i acute	i ´	í
i circumflex	i ^	î
i umlaut	i "	ï
n tilde	n ~	ñ
o grave	o `	ò
o acute	o ´	ó
o circumflex	o ^	ô
o tilde	o ~	õ
o umlaut	o "	ö
o slash	o /	ø
u grave	u `	ù
u acute	u ´	ú
u circumflex	u ^	û
u umlaut	u "	ü
y umlaut	y "	ÿ



APPENDIX B

Character Set Diagrams

This appendix shows the character set diagrams for the five character sets available with the HDS3200 Series terminals. The terminal model you have will have four of these character sets in memory. Graphics terminals, when in Graphics -- Alpha mode, use the ASCII character set with some variations of the dot patterns, depending on the sizes of the characters being generated. The HDS3200 Series terminals with the APL option can use either the ASCII or APL character set and switch between them while in graphics mode.

ASCII character set

000	001	002	003	004	005	006	007	008	009	010	011	012	013	014	015
W	E	E	E	E	E	E	E	E	E	E	E	E	E	E	E
U	X	X	X	X	X	X	X	X	X	X	X	X	X	X	X
016	017	018	019	020	021	022	023	024	025	026	027	028	029	030	031
D	B	B	B	B	B	B	B	B	B	B	B	B	B	B	B
L	A	A	A	A	A	A	A	A	A	A	A	A	A	A	A
032	033	034	035	036	037	038	039	040	041	042	043	044	045	046	047
U	A	A	A	A	A	A	A	A	A	A	A	A	A	A	A
048	049	050	051	052	053	054	055	056	057	058	059	060	061	062	063
0	1	2	3	4	5	6	7	8	9	:	:	<	=	>	?
064	065	066	067	068	069	070	071	072	073	074	075	076	077	078	079
G	A	B	C	D	E	F	G	H	I	J	K	L	M	N	O
080	081	082	083	084	085	086	087	088	089	090	091	092	093	094	095
P	Q	R	S	T	U	V	W	X	Y	Z	[	]	^	_	~
096	097	098	099	100	101	102	103	104	105	106	107	108	109	110	111
a	b	c	d	e	f	g	h	i	j	k	l	m	n	o	
112	113	114	115	116	117	118	119	120	121	122	123	124	125	126	127
p	q	r	s	t	u	v	w	x	y	z	[	]	^	_	~

DEC Special Graphics character set

000	001	002	003	004	005	006	007	008	009	010	011	012	013	014	015
016	017	018	019	020	021	022	023	024	025	026	027	028	029	030	031
032	033	034	035	036	037	038	039	040	041	042	043	044	045	046	047
048	049	050	051	052	053	054	055	056	057	058	059	060	061	062	063
064	065	066	067	068	069	070	071	072	073	074	075	076	077	078	079
080	081	082	083	084	085	086	087	088	089	090	091	092	093	094	095
096	097	098	099	100	101	102	103	104	105	106	107	108	109	110	111
112	113	114	115	116	117	118	119	120	121	122	123	124	125	126	127

DEC Technical character set (not on APL option)

000	001	002	003	004	005	006	007	008	009	010	011	012	013	014	015
016	017	018	019	020	021	022	023	024	025	026	027	028	029	030	031
032	033	034	035	036	037	038	039	040	041	042	043	044	045	046	047
048	049	050	051	052	053	054	055	056	057	058	059	060	061	062	063
064	065	066	067	068	069	070	071	072	073	074	075	076	077	078	079
080	081	082	083	084	085	086	087	088	089	090	091	092	093	094	095
096	097	098	099	100	101	102	103	104	105	106	107	108	109	110	111
112	113	114	115	116	117	118	119	120	121	122	123	124	125	126	127



APL character set (with APL option only)

000	001	002	003	004	005	006	007	008	009	010	011	012	013	014	015
016	017	018	019	020	021	022	023	024	025	026	027	028	029	030	031
032	033	034	035	036	037	038	039	040	041	042	043	044	045	046	047
048	049	050	051	052	053	054	055	056	057	058	059	060	061	062	063
064	065	066	067	068	069	070	071	072	073	074	075	076	077	078	079
080	081	082	083	084	085	086	087	088	089	090	091	092	093	094	095
096	097	098	099	100	101	102	103	104	105	106	107	108	109	110	111
112	113	114	115	116	117	118	119	120	121	122	123	124	125	126	127

## APPENDIX C

### Printer Setup Suggestions

This appendix contains some suggestions for connecting the printers selectable from Setup Mode to the terminal. This information is intended to help you select the options which permit the printer and the terminal to communicate correctly.

This information does not substitute for the printer instruction manual or the particular requirements of your environment, nor can it reflect changes which the manufacturer might make in the printer design or setup configuration, so use these suggestions carefully and together with the printer's setup instructions.

The first step in setting up your printer is to find your printer on the list of those printers the terminal supports, or find out which printer format your printer is similar to or emulates. Then consult the printer manuals and the suggestions in this manual and this appendix and make the cable connections and switch settings needed for correct communication. All of the printers listed below, when using the XON/XOFF protocol, use straight through cables to connect with the terminal.

You must make two selections from Setup Mode: the Graphics Printer and the Printed Data Type. You probably will also make other selections for baud rate, parity, etc.

Now run a few simple tests to check the settings you've made. Make sure the printer is ready to operate. Put the terminal in Local mode operation and fill the screen with characters (the Self Test command **Cmd [ =2 y** prints all the character sets) or enough characters that the printer will have to use its overflow protocol to stop transmission for a moment, and then press Prnt Scrn to send them to the printer. This tests the operation of the baud rate, parity, stop bits, and protocols. If the first few lines of characters are transmitted, but the rest are garbled or missing, the basic transmission is working but the overflow protocol is not. Be sure you have selected the correct Printed Data Type in Setup Mode to send Multinational characters.

You should also test the graphics printing capability of the connections. Run the graphics self test ( **Cmd [ =4 y** ), then press Prnt Scrn. This tests the graphics protocols and communications for large amounts of data.

When these tests run as indicated, you can be confident the connections are correct. You might now want to put the terminal into On-Line Mode and check communications with the host computer's software, or with a word processor's printing commands to make sure the software is installed correctly for the terminal's printing operations.

The Printed Data Type field of the Port 2 Communications Setup Menu allows you to select the type of text characters that are sent by the terminal to the printer, and depends chiefly on the capability of the printer. The National Only option means that the terminal sends only ASCII characters (command sequences to change character set or attributes are ignored). The National and

Line Drawing option means that ASCII and Graphics characters are sent to the printer along with commands to switch the printer into G0 and G1 character sets. Changes in character attributes (or graphic rendition) are sent to the printer as escape sequences and characters from the International character set are printed as equivalent ASCII characters. The Multinational option means that ASCII, graphics, and International characters are sent, with the command sequences to select them, to the printer. The All Characters option means that all character sets, ASCII, Special Graphics, Multinational, and DEC Technical, are sent. Changes in character attributes are sent as escape sequences.

**Printed Data Type Setup Mode Selections**

Setup Option	Character Sets Transmitted				Character Attributes
	ASCII	Special Grap.	Multinational	DEC Tech	
National Only	X				None sent
Line Drawing	X	X			X
Multinational	X	X	X		X
All Characters	X	X	X	X	X

## HDS3200 Owner's Manual

**Printer:** DEC LA75

### **Terminal Settings**

Setup Mode Graphics Printer Selection: LA75

Setup Mode Communications Settings (Port 2):

Baud Rate: 4800

Data/Parity: 8/None

Stop Bits: 2

Printed Data Type: All Characters

### **Printer Settings**

Baud Rate	4800
Data Bits and Parity	8-None
Protocol	DEC
Form Length	11 inches
Character Set (DEC)	U.S. ASCII
Supplemental Character Set	DEC Supplemental
Print Density	Draft
Printer ID	LA50 ID
Auto LF on CR	No Auto LF
Auto CR on LF	No Auto CR
80 or 132 Columns	80 Columns
Paper Out Bell	On
Active Character Set	Graphics Set A
Power-up Density	Draft
LQ or NLQ	Select NLQ

Notes:

**\*\*** These are factory settings for the LA75. No changes are necessary.



Printer: DEC LA50/100

**Terminal Settings**

Setup Mode Graphics Printer Selection: LA75  
Setup Mode Communications Settings (Port 2):  
Baud Rate: 4800  
Data/Parity: 7/Spac  
Stop Bits: 2  
Printed Data Type: Multinational

**Printer Settings**

DIP Switch Settings:

Switch SW1

1 open  
2 open  
3 open  
4 open  
5 closed (selects 180 dpi)  
6 open (selects XON/XOFF)  
7 open  
8 open

Switch SW2

1 open  
2 open (1,2,3 = 4800 baud)  
3 open  
4 closed  
5 open (4,5,6 = 7 bit/Sp)  
6 closed  
7 open  
8 open

Notes:

\*\* You must select one of the 7 bit settings for SW2-#4,5,6. 8 bit settings may not work with the terminal.

\*\* You must set SW1-#5 CLOSED in order to print graphics.

\*\* The DEC LA 100 printer is the same as the DEC LA 50 for printing graphics.

## HDS3200 Owner's Manual

**Printer:** Epson FX80

### **Terminal Settings**

Setup Mode Graphics Printer Selection: FX80  
Setup Mode Communications Settings (Port 2):  
Baud Rate: 9600  
Data/Parity: 8/None  
Stop Bits: 1  
Printed Data Type: National Only

### **Printer Settings**

#### DIP Switch Settings:

##### Switch SW1

1 off (select 8 bits)  
2 off (disable parity check)  
3 off  
4 off  
5 off  
6 on (5,6,7,8 select  
7 off 9600 baud)  
8 off

##### Switch SW2

1 on  
2 on  
3 off  
4 off  
5 off  
6 off

#### Notes:

**\*\*** You must have the optional intelligent serial interface card installed in the FX80 printer.

**\*\*** Printing HDS3200 Series graphics requires 8 data bit communications.

**Printer:** C. Itoh Prowriter

**Terminal Settings**

Setup Mode Graphics Printer Selection: C. Itoh

Setup Mode Communications Settings (Port 2):

Baud Rate: 9600

Data/Parity: 7/Even

Stop Bits: 2

Printed Data Type: National Only

**Printer Settings**

**DIP Switch Settings:**

**Switch SW1**

1 open  
2 closed  
3 open  
4 open  
5 open  
6 open  
7 open  
8 open

**Switch SW2**

1 open  
2 open  
3 open  
4 open  
5 open  
6 closed  
7 closed  
8 closed

## HDS3200 Owner's Manual

**Printer:** Anadex DP 9620A

### Terminal Settings

Setup Mode Graphics Printer Selection: Anadex

Setup Mode Communications Settings (Port 2):

Baud Rate: 9600

Data/Parity: 7/None

Stop Bits: 2

Printed Data Type: National Only

### Printer Settings

#### DIP Switch Settings:

##### Front Switches:

###### Switch S14

- 1 open/off
- 2 open/off
- 3 open/off
- 4 open/off
- 5 closed/on
- 6 open/off
- 7 closed/on (7,8 XON/XOFF
- 8 closed/on protocol out)

###### Switch S15

- 1 open/off
- 2 closed/on
- 3 closed/on
- 4 open/off
- 5 closed/on
- 6 closed/on
- 7 closed/on
- 8 open/off

##### Back Switches:

###### Switch S3

- 1 on (select serial interface)
- 2 on (select 2 stop bits)
- 3 on
- 4 on (3,4,5,6 select
- 5 on 9600 baud)
- 6 on
- 7 off (select 7 data bits)
- 8 off
- 9 off (8,9,10 select
- 10 off no parity)

###### Switch S1

- 1 off
- 2 off
- 3 off
- 4 off

**Printer:** Okidata Microline 92

**Terminal Settings**

Setup Mode Graphics Printer Selection: Okidata

Setup Mode Communications Settings (Port 2):

Baud Rate: 9600

Data/Parity: 7/Spac

Stop Bits: 1

Printed Data Type: National Only

**Printer Settings**

DIP Switches (on RS-232 Serial Interface Board)

**SW1**

- 1 - off
- 2 - on (no parity)
- 3 - off (8 data bits)
- 4 - on
- 5 - off (4,5,6,7 select)
- 6 - off 9600 baud)
- 7 - off
- 8 - off (CR block end code)

**SW2**

- 1 - on (1,2,3 select
- 2 - off XON/XOFF handshaking)
- 3 - off
- 4 - off (select DTR)
- 5 - off (5,6 select
- 6 - off busy as low)
- 7 - off (ignore CD)
- 8 - on (block = 2K bytes)

**Front Panel Switches**

- 1 - off
- 2 - off (1,2,3,4 select
- 3 - off US ASCII)
- 4 - off
- 5 - on (8.5" page)
- 6 - off (Auto LF off)
- 7 - on (Delete code printed)
- 8 - on (Serial Interface)

## HDS3200 Owner's Manual

**Printer:** Integral Data Systems (IDS) PRISM 80/132

### Terminal Settings

Setup Mode Graphics Printer Selection: Okidata

Setup Mode Communications Settings (Port 2):

Baud Rate: 9600

Data/Parity: 7/Spac

Stop Bits: 1

Printed Data Type: National Only

### Printer Settings

#### DIP Switch Settings

##### Switch Group S4

- 1 - on (1,2 select 12 cpi)
- 2 - off
- 3 - on (8 lpi)
- 4 - off (no auto boundary skip)
- 5 - off (no auto LF)
- 6 - off (draft mode)
- 7 - on (enable expanded function)

##### Switch Group S5

- 1 - on
- 2 - off (1,2,3 select
- 3 - on 11" paper)
- 4 - on
- 5 - off (4,5 select 9600 baud)
- 6 - off (no parity checking)
- 7 - off (space parity)

#### Notes:

**\*\* You must select Switch 5 on group S4 OFF and Switch 7 on group S4 ON in order to print HDS3200 Series graphics.**

**Printer:** HP Thinkjet (HP 2225D - RS-232)

**Terminal Settings**

Setup Mode Graphics Printer Selection: Thinkjet

Setup Mode Communications Settings (Port 2):

Baud Rate: 9600

Data/Parity: 8/None

Stop Bits: 1

Printed Data Type: National Only

**Printer Settings**

**Mode Switches**

1 - down (CR does only CR)

2 - down (LF does only LF)

3 - down (don't skip perforation)

4 - down (page length 11 inches)

5 - up (alternate mode)

6 - up

7 - down (6,7,8 select US ASCII)

8 - down

**RS-232 switches**

1 - down (XON/XOFF handshaking)

2 - down (2,3 select

3 - down 8/None parity)

4 - down

5 - down (4,5 select 9600 baud)

Notes:

**\*\* You must select Mode Switch 5 UP in order to print HDS3200 Series graphics.**

**Printer:** HP Laserjet II

**Terminal Settings**

Setup Mode Graphics Printer Selection: Laserjet II

Setup Mode Communications Settings (Port 2):

Baud Rate: 9600

Data/Parity: 8/None

Stop Bits: 1

Printed Data Type: National Only

**Printer Settings**

SW1 Switches

1 - off (no function)

2 - on (2,3,4 select

3 - off 9600

4 - on baud)

5 - off (no function)

6 - off (no function)

7 - off (no function)

8 - on (DTR active high)

Notes:

**\*\* You must have the HP Laserjet Plus or II model, not just the HP Laserjet, to support HDS3200 Series graphics printing.**



## APPENDIX D

### HDS3200 APL Model Terminal Operating Differences

This appendix discusses the differences between the features and operation of the ASCII model of the HDS3200 terminal and the terminal with the APL option. The selection and operation of the commands and processing modes described here is automatic for APL terminals. This information is not necessary for using the APL terminal effectively, though it may help you understand some of the things you observe. Refer to the *HDS3200 Programmer's Reference Manual* for further details.

The main differences between the two terminals is the keyboard and the corresponding character sets, ASCII and APL. Since the character sets are quite different, terminal commands, and the corresponding keyboard characters, often have to be reinterpreted from the ASCII characters and code numbers to the APL characters which produce the appropriate code numbers. Remember that a command is a sequence of ASCII codes or chart locations, not the characters that represent those codes in some particular character set.

The APL character set replaces the DEC Technical character set on terminals with the APL option.

The APL language utilizes a number of overstrike characters, and these require special terminal processing. The HDS3200 APL terminal has 52 overstrike characters defined at the factory. An additional 44 may be defined by the user. These are stored automatically in the Downline Loadable character set. Details of storing and replacing these overstrike characters is contained in the *HDS3200 Programmer's Reference Manual*.

If you create a triple overstrike character by typing a character over an overstrike, the triple overstrike is converted to a special character, an inverted question mark, which replaces the RUBOUT character (chart position 127) of the APL character set.

The Graphics Status Line and the Arc/Circle Drawing commands are not present in the HDS3200 APL terminal.

### Appendix E

#### VT52 Mode Terminal Operation

The HDS3200 terminal emulates a DEC VT52 terminal when the VT52 operating mode is selected from Setup Mode. This mode of operation does not use ANSI standards for command structure and most of the common terminal commands (except those available in Setup Mode) are inoperative when the terminal is in VT52 mode. Other settings, such as the User Defined Key assignments, are also different. The Quick Reference Guide and the *HDS3200 Programmer's Reference Manual* give lists of VT52 commands and key definitions.

You can enter and exit VT52 mode operation from Setup Mode. When you are in VT52 operating mode the terminal will not recognize ANSI commands. You must use Setup Mode or the VT52 mode command `ESC <` to return to ANSI mode operation.

VT52 Mode terminal operation supports only 7 bit data communications.

#### VT100 Mode Terminal Operation

The HDS3200 terminal emulates a DEC VT100 terminal when VT100 operating mode is selected in Setup Mode. Generally, programs designed to operate on VT100 terminals will operate in VT220, 7-bit mode. However, if strict compatibility with VT100 terminal operation is required, use the VT100 operating mode of the HDS3200.

Setup Mode and its associated commands are available in all terminal operating modes. However, other VT200 mode commands are unavailable in VT100 operating mode, including commands to map the character sets, program the User Defined Keys, load the Downline Loadable Character Set, and Compose Mode. For a complete list and more details refer to the *HDS3200 Programmer's Reference Manual*.

In VT100 operating mode, the DEC VT220 terminal disables the default definitions of the User Defined Keys and assigns keys F11, F12, F13 to function as Escape, Back Space, and Line Feed. The HDS3200 terminal follows this assignment even though Escape, Back Space, and Line Feed are keys available on the main keypad. The HDS3200 User Defined Keys all operate in VT100 mode and can be redefined from Setup Mode any time.

VT100 Mode terminal operation supports only 7 bit data communication.

**Appendix F**

**Optional Video Output Connection**

HDS3200 Series terminals can be ordered with a factory modification which makes the video signal of the terminal available on a separate BNC connector mounted on the back panel between the third port and the power cord socket. The video signal can be used by monitors which respond to the following specifications:

Horizontal Scan Rate: 25.5 KHz  
Vertical Scan Rate: 60 Hz  
Band Width: 20 MHz

## Quick Reference ANSI Command Listing

All supported ANSI commands are documented in this section, separated by function. The following conventions are used:

**ESC**: escape character (ASCII chart location 027)

**CSI**: control sequence introducer (ASCII chart location 155 in 8-bit mode, or **ESC I**, ASCII chart locations 027 091 in 7-bit mode)

**DCS**: device control string (ASCII chart location 144 in 8-bit mode, or **ESC P**, ASCII chart locations 027 080 in 7-bit mode)

**ST**: string terminator (ASCII chart location 156 in 8-bit mode, or **ESC \**, ASCII chart locations 027 092 in 7-bit mode)

**CTRL**: indicates a control code (ASCII chart location 0 - 31).

**Sp**: space character (ASCII chart location 032)

*italics*: indicate parameters

i>

**bold**: indicates default values for parameters

**\***: indicates a command available only with terminal options

## Operating Mode Commands

---

Command Name	Setup	Command Sequence
Local Mode	Genl	CSI = 22 h
On-Line Mode	Genl	CSI = 22 l
Control Code Processing	Genl	
VT200 Mode, 7-bit Controls	Genl	CSI 62 ; 1 " p
VT200 Mode, 8-bit Controls	Genl	CSI 62 " p
Select 7-bit Controls	Genl	ESC Sp F
Select 8-bit Controls	Genl	ESC Sp G
VT100 Mode	Genl	CSI 61 " p
VT52 Mode	Genl	CSI ? 2 l
Setup Mode		<u>Setup</u>
<u>Setup</u> Key Enabled		CSI = 34 h
<u>Setup</u> Key Disabled		CSI = 34 l
Calculator Mode		<u>Comp Char Enter</u>
Zoom Definition Mode *		<u>Comp Char Z</u>
Pan Definition Mode *		<u>Comp Char P</u>
HDS Extensions Enabled		CSI = 35 h
HDS Extensions Disabled		CSI = 35 l

---

## Graphics Interface Commands

Command Name	Setup	Command Sequence
Enter Graphics/Alpha Mode - Clear Screen		ESC FF (CTRL L)
Enter Graphics/Vector Mode		GS (CTRL J)
Enter Graphics/Point Plot Mode		FS (CTRL \)
Enter Graphics/Incremental Point Plot Mode		RS (CTRL ^)
Enter Graphics/Alpha Mode	Genl	ESC [ <i>gmode</i> / w
Display Currently Inactive Memory	Graph	ESC [ = 25 l
Blank Currently Inactive Memory	Graph	ESC [ = 25 h
Blank Alpha/Graphics Screen		ESC [ <i>blank</i> / v
Define No Alternate Grph. Exit Chr.		ESC [ = 30 l
Define CTRL F Alternate Grph. Exit Chr.		ESC [ = 30 h
Screen Resolution (Medium) *	Graph	ESC [ = 31 l
Screen Resolution (High) *	Graph	ESC [ = 31 h
Disable Automatic Graphics Entry		ESC [ = 36 l
Enable Automatic Graphics Entry		ESC [ = 36 h
Enter 4014 Mode		ESC [ ? 38 h
Exit 4014 Mode,Enter VT220 Mode		ESC [ ? 38 l
Normal Graphics Print		ESC [ ? 43 h
Compressed Graphics Print		ESC [ ? 43 l
Port 3/Mouse Control	Comm	ESC [ <i>port3;track;active</i> / z

### Parameters:

*active* selects the activity of the mouse

- 0 = mouse active in Graphics and Setup Modes only
- 1 = mouse active in Graphics, ANSI, and Setup Modes

*blank* selects the alpha and/or graphics memory display

- 0 = unblank alpha memory
- 1 = blank alpha memory
- 2 = unblank graphics memory
- 3 = blank graphics memory

*gmode* controls the entry or exit from graphics mode

- 0 = enter graphics, alpha mode
- 1 = enter graphics, alpha mode, clear screen
- 2 = exit graphics mode

*port3* selects the type of input for port 3

- 0 = Normal (RS-232) port
- 1 = HDS Mouse
- 2 = MM1201 (full pad) Digitizer
- 3 = MM1201 (partial pad) Digitizer
- 4 = MM961/MM1812 Digitizer
- 5 = Bit Pad One Digitizer

*track* selects the tracking ratio of the mouse, (ratio = mouse:screen movement)

- 0 = 1:2
- 1 = 1:1
- 2 = 2:1
- 3 = 4:1

## Reset and Self Test Commands

---

Command Name	Setup	Command Sequence
Hard Terminal Reset	Genl	ESC c
Soft Terminal Reset	Genl	CSI ! p
Clear Communications Ports	Genl	
Save Settings In NVM	Genl	
Reset NVM To Factory Default	Genl	
Terminate Command Sequence		SUB (CTRL Z)
Alternate		CAN (CTRL X)
Terminal Self Test		CSI = <i>test</i> y
Screen Alignment Pattern		ESC # 8

---

### Parameters:

*test* specifies the test(s) to be performed:

- 0 = Memory (RAM, ROM, NVM)
- 1 = Communications
- 2 = Character/attribute display
- 4 = Graphics fill pattern display
- 5 = Dimmed display (screen saver)
- 8 = Screen alignment pattern
- 9 = Repeat test(s) until error occurs

Note: multiple values may be entered, separated by semicolons.

## Character Set Commands

---

Command Name	Setup	Command Sequence
Define G0 Character Set		ESC ( <i>cset</i>
Define G1 Character Set		ESC ) <i>cset</i>
Define G2 Character Set		ESC * <i>cset</i>
Define G3 Character Set		ESC + <i>cset</i>
Lock Shift G0 into GL		SI (Ctrl O)
Lock Shift G1 into GL		SO (Ctrl N)
Lock Shift G2 into GL		ESC n
Lock Shift G3 into GL		ESC o
Lock Shift G1 into GR		ESC ~
Lock Shift G2 into GR		ESC }
Lock Shift G3 into GR		ESC
Single Shift G2 into GL		SS2 (ESC N)
Single Shift G3 into GL		SS3 (ESC O)

## HDS3200 Owner's Manual

Downline Loadable Character Sets	DCS <i>font;chnum;cerase;cms;</i> <i>wid;text { dscs sixel;sixel;... ST</i>
Expand Character Set (DEC)	CSI = 28 l
Do Not Expand Character Set (HDS)	CSI = 28 h

---

### Parameters:

*cerase* specifies which characters to erase in the character set

- 0 = 2 = erase all characters before loading**
- 1 = erase only the characters being reloaded

*chnum* gives the starting character number.

- 0 = 1 = ASCII chart location 33**
- Valid values for DEC VT220 (expanded character set, mode =28 reset) are 1 to 94 (ASCII chart locations 33 to 126). Valid values for HDS3200 (unexpanded character set, mode =28 set) are 1 to 95 (ASCII chart locations 33 to 127) and 100 to 132 (ASCII chart locations 0 to 32).

*cms* specifies the character matrix size (parameter is ignored)

- 0 = device default (7 x 10)**

*cset* specifies the character set

- B = ASCII
- 0 = DEC Special Graphics
- > or 1 = DEC Technical (> recommended; not available with APL option)
- 8 = APL (if APL option is installed)
- < = Multinational
- dscs*, if defined, is also legal.

*dscs* Defines the character set name for the RAM character set. This is composed of 0-2 intermediate characters (ASCII chart locations 32-47) and a final character (ASCII chart location 64-126).

*font* specifies the font buffer number (parameter is ignored).

*sixel* gives the sixel bit pattern for characters.

Slash (ASCII chart location 47) is used to separate upper/lower columns of the characters. Semi-colon (ASCII chart location 59) is used to separate sixel bit patterns for successive characters.

*text* specifies a text or full-cell font (parameter is ignored).

- 0 = 1 = device default (text)**

*wid* gives the width attribute (parameter is ignored).

- 0 = 1 = device default (80 columns)**

## Communications Commands

---

Command Name	Setup	Command Sequence
Local Echo	Comm	CSI 12 1
No Local Echo	Comm	CSI 12 h
Limit Transmit Rate	Comm	CSI ? 73 h
Don't Limit Transmit Rate	Comm	CSI ? 73 1
Stop Transmission		XOFF (CTRL S)
Resume Transmission		XON (CTRL Q)
Set Flow Controls	Comm	CSI <i>xonxof;xofhst;ctsrts;port / r</i>
Delay		CSI <i>ticks;secs / ~</i>
Fill Character		NUL (CTRL @)
Break Command		<u>Break</u>
Disconnect/Long Break		<u>Shift Break</u>

---

### Parameters:

*ctsrts* determines the use of the CTS protocol

- 0 = CTS not required for transmission**
- 1 = CTS required high for transmission**
- 2 = SPI option, RTS toggled (Port 2 only)**

*port* specifies the port for communication

- 0 = requesting device, or Host On Port selection**
- 1 = Port 1**
- 2 = Port 2**
- 3 = Port 3**

*secs* specifies the seconds of delay

**Default = 0 Max = 255**

*ticks* specifies the delay in 1/60 seconds

**Default = 1 Max = 255**

*xofhst* specifies XON/XOFF protocol activity from the host

- 0 = XON/XOFF disabled incoming**
- 1 = XON/XOFF enabled incoming**

*xonxof* specifies XON/XOFF protocol activity from the terminal

- 0 = XON/XOFF disabled outgoing**
- 1 = XON/XOFF enabled outgoing; XOFF sent at 64**
- 2 = XON/XOFF enabled outgoing; XOFF sent at 128**



## Character Processing Commands

---

Command Name	Setup	Command Sequence
Replace Character Mode		CSI 4 l
Insert Character Mode		CSI 4 h
Auto Wrap Mode Off	User Pref	CSI ? 7 l
Auto Wrap Mode On	User Pref	CSI ? 7 h
Select Graphic Rendition		CSI <i>rendtn</i> m
Set Character Erasability		CSI <i>selclr</i> " q
Repeat Character		CSI <i>char</i> ; <i>rptcls</i> / p
Double-Height/Double-Width - Top Line		ESC # 3
Double-Height/Double-Width - Bottom Line		ESC # 4
Double-Width Line		ESC # 6
Single Width Line		ESC # 5

---

### Parameters:

*rendtn* specifies the graphic rendition used

- 0 = All Attributes Off**
- 1 = Bold
- 4 = Underline
- 5 = Blinking
- 7 = Negative Image
- 8 = Invisible
- 22 = Bold Off
- 24 = Underline Off
- 25 = Blinking Off
- 27 = Negative Image Off
- 28 = Visible

Note: Multiple values may be entered, separated by semicolons. Values are processed sequentially, so 0 first initializes the list to the normal state.

*char* gives the ASCII chart location of character (values 000-127)

*rptcls* specifies the number of times the character is displayed, limited by number of columns left in this line. **Default = 1**

*selclr* specifies which characters are erasable

- 0 = erasable**
- 1 = not erasable
- 2 = erasable, same as 0

## Keyboard Operation Commands

Command Name	Setup	Command Sequence
Lock Keyboard		CSI 2 h
Unlock Keyboard		CSI 2 l
Enable <i>Setup</i> Key		CSI = 34 l
Disable <i>Setup</i> Key		CSI = 34 h
Auto Repeat On	Kybd	CSI ? 8 h
Auto Repeat Off	Kybd	CSI ? 8 l
Ring Keyboard Bell		BEL (CTRL G)
Cursor Keypad Operation - Normal	Kybd	CSI ? 1 l
Cursor Keypad Operation - Application	Kybd	CSI ? 1 h
Numeric Keypad Operation - Normal	Kybd	ESC >
Alternate	Kybd	CSI ? 66 l
Numeric Keypad Operation - Application	Kybd	ESC =
Alternate	Kybd	CSI ? 66 h

## User Defined Key Commands

Command Name	Setup	Command Sequence
Program UDK (DEC Private)		DCS <i>clear; lock  </i> <i>key1/def1; key2/def2;... ST</i>
Program UDK (HDS Private)		DCS = <i>clear; lock; nvm; local  </i> <i>key1/def1; key2/def2;... ST</i>
Program UDK (HDS ASCII)		CSI <i>key;nvm;local - u del ASCIIdata del</i>
Execute UDK		CSI <i>key / x</i>
Use 1 UDK Set	UDK	CSI = 33 l
Use 3 UDK Sets	UDK	CSI = 33 h
Select UDK Set	UDK	CSI <i>setnum;dev - x</i>

**Note:** Default values for *nvm* and *local* are assumed for the DEC private sequence. In the DEC command only shifted User Defined Keys may be specified by the *key* parameter. Use an HDS private sequence to select different values for these parameters.

### Parameters:

*ASCIIdata* indicates normal ASCII characters (ASCII 32 to 126) in the definition. Control codes must use special designations with the backslash introducer (\):

Control Codes	Sequence	ASCII Chart Location
carriage return	\r	013
line feed	\n	010
tab	\t	009
backspace	\b	008

## HDS3200 Owner's Manual

form feed	\f	012
backslash	\\	092
escape	\e	027
bell	\a	007
octal value	\nnn (three digits needed)	

Note: if *local* is 1, then \377 is Cmd.

*clear* specifies which key definitions to clear

- 0 = clear all keys before loading new values.**
- 1 = load new key values; clear old only where defined

*def* gives the key definition, in two-digit hexadecimal numbers representing the chart locations of the characters. If *local* is 1, then FF = Cmd.

*del* indicates any non-control code delimiter character. This may be any character not used in the definition itself. It must be used identically at the beginning and end of the definition.

*dev* specifies the device to which the command applies

- 0 = requesting device**
- 1 = Port 1
- 2 = Port 2
- 3 = Port 3
- 9 = Keyboard

*key* gives the key number. (See **Keychart** at the end of the ANSI command listing section). Note that there are different permitted values for DEC and HDS commands.

*local* specifies the local interpretation of the ESC control code

- 0 = normal programming.**
- 1 = value of FF (hex) or \377 (octal) indicates local Cmd key

*lock* permits locking the keys against redefinition

- 0 = lock the keys.** (May only be unlocked in Setup mode.)
- 1 = do not lock the keys.

*nvm* specifies temporary or permanent storage of the key definition

- 0 = temporary (RAM) version of key(s).**
- 1 = permanent (NVM) version of key(s).

*setnum* selects the set of UDK definitions to use

**Default = 1** Values 1, 2, or 3.

## Cursor Control Commands

---

Command Name	Setup	Command Sequence
Define Scrolling Region		CSI <i>top</i> ; <i>bot</i> r
Cursor Addressing - Window Relative		CSI ? 6 l
Cursor Addressing - Scrolling Region Relative		CSI ? 6 h
Carriage Return		CR (CTRL M)
Line Feed		LF (CTRL J)
Line Feed Processing - Line Feed	User Pref	CSI 20 l
Line Feed Processing - New Line	User Pref	CSI 20 h
Vertical Tab		VT (CTRL K)
Form Feed		FF (CTRL L)
Form Feed Processing - Line Feed	User Pref	CSI = 23 l
Form Feed Processing - Clear Window	User Pref	CSI = 23 h
Back Space		BS (CTRL H)
Index		ESC D
New Line		ESC E
Reverse Index		ESC M
Cursor Up		CSI <i>repeat</i> A
Cursor Down		CSI <i>repeat</i> B
Cursor Right		CSI <i>repeat</i> C
Cursor Left		CSI <i>repeat</i> D
Position Cursor		CSI <i>lin</i> ; <i>col</i> H
Alternate		CSI <i>lin</i> ; <i>col</i> f
Save Cursor		ESC 7
Restore Cursor		ESC 8
Transmit Cursor Position		CSI 6 n
Tab		HT (CTRL I)
Tab Set	Genl	ESC H
Tab Control	Genl	CSI <i>clrtab</i> g
Reset Tabs	Genl	CSI = 0 g

---

### Parameters:

*bot* gives the bottom line of scrolling region.  
**Default = 24** (or bottom line of window)

*clrtab* controls the tab settings  
**0 = clear tab stop at cursor position**  
**3 = clear all text tab stops**

*col* specifies the column position.  
**Default = column 1 in window.**

*lin* specifies the line position.  
**Default = line 1 in window or region.**

*repeat* gives the number of times to repeat command.  
**Default = 1**

*top* gives the top line of scrolling region.  
**Default = 1**

## Editing Commands

---

Command Name	Setup	Command Sequence
Insert Character		CSI <i>repeat</i> @
Delete Character		CSI <i>repeat</i> P
Insert Line		CSI <i>repeat</i> L
Delete Line		CSI <i>repeat</i> M
Erase Character		CSI <i>repeat</i> X
Erase In Line		CSI <i>erase</i> K
Erase In Window		CSI <i>erase</i> J
Set Character Erasability		CSI <i>selclr</i> " q
Selective Erase In Line		CSI ? <i>erase</i> K
Selective Erase In Window		CSI ? <i>erase</i> J

---

### Parameters:

*erase* specifies the location to be erased

- 0 = erase from cursor to end of window/line
- 1 = erase from beginning of window/line to cursor
- 2 = erase entire window/line

*repeat* specifies the number of times to repeat command

**Default = 1.**

*selclr* specifies whether characters are erasable

- 0 = 2 = erasable
- 1 = not erasable

## Printing/Networking Commands

---

Command Name	Setup	Command Sequence
Print Control		CSI <i>prtctl</i> i
Print Screen		<u>Print Scrn</u>
Autoprint Toggle		<u>Ctrl Print Scrn</u>
No Print Termination	Comm	CSI ? 18 l
FF Print Termination	Comm	CSI ? 18 h
Print Scrolling Region	Comm	CSI ? 19 l
Print Full Window	Comm	CSI ? 19 h
Network Controller Mode		CSI <i>dest:dev</i> / u
Set Host Port *	HDS Ext	CSI <i>host</i> / q
Set Printer Buffer *	Graphics	CSI <i>bufsize</i> - p

---

**Note:** The printer buffer uses memory allocated from Graphics Display List memory; thus it is available only on terminals equipped with this option. The printer buffer operates only on Port 2 for all output (ANSI text and graphics) to Port 2.

**Parameters:**

*bufsize* selects the size of the printer buffer

- 0 = no printer buffer**
- 64 = allocate 64K for printer buffer
- 128 = allocate 128K for printer buffer

*dest* specifies the network destination

- 0 = none; turn off Network Controller Mode**
- 1 = Port 1
- 2 = Port 2
- 3 = Port 3
- 9 = Display

Note: Multiple values may be entered, separated by semicolons.

*dev* specifies the device to be networked

- 0 = requesting device**
- 1 = Port 1
- 2 = Port 2
- 3 = Port 3
- 9 = Keyboard

*host* specifies the main or host port

- 0 or 1 = Port 1**
- 2 = Port 2
- 3 = Port 3 \*

*prtctl* specifies the printer operation mode

- 0 = Print (scrolling region or window depends on Mode ?19)**
- ?1 = Print line
- 4 = Printer controller mode off
- 5 = Printer controller mode on
- ?4 = Auto-print mode off
- ?5 = Auto-print mode on
- ?8 = Printer to Host off
- ?9 = Printer to Host on

## Display Preference Commands

---



---

Command Name	Setup	Command Sequence
25 Line Screen *	User Pref	CSI = 32 l
50 Line Screen *	User Pref	CSI = 32 h
Jump Scroll	User Pref	CSI ? 4 l
Smooth Scroll	User Pref	CSI ? 4 h
Normal Screen Video	User Pref	
Reverse Screen Video	User Pref	
Text Cursor Enabled	Kybd	CSI ? 25 h
Text Cursor Disabled	Kybd	CSI ? 25 l

---



---

## Window Commands

---

Command Name	Setup	Command Sequence
Assign Device Windows		CSI <i>dev</i> ;w1;w2;... - q
Select Window	HDS Exten	CSI <i>wnum</i> ;dev;copy - z
Assign ANSI Memory Range		CSI <i>win</i> ;sline;eline - v
Define Window	HDS Exten	CSI <i>wtop</i> ;wbot;lft;rgt - w
Copy Window		CSI <i>src</i> ;dst + q
Reset Windows To Default	HDS Exten	CSI <i>reset</i> - ~
Save/Restore Window		CSI <i>savres</i> ;dev - y
Normal Screen Video (Window)	HDS Exten	CSI ? 5 l
Reverse Screen Video (Window)	HDS Exten	CSI ? 5 h
Set 80 Column Display	User Pref	CSI ? 3 l
Set 132 Column Display	User Pref	CSI ? 3 h
Clear Screen On 80-132 Change	User Pref	CSI = 21 l
Don't Clear On 80-132 Change	User Pref	CSI = 21 h
Draw/Eraser Border		CSI <i>bdr</i> - t
Define Scrolling Region		CSI <i>top</i> ;bot r
Write Onto Page Number		CSI <i>wpage</i> ;dev / t
Select Viewport		CSI <i>vport</i> ;dev + v

---

### Parameters:

*bdr* This command draws a border around the current window. The border will not be drawn if any window edge coincides with a currently defined memory boundary (line 1 or 96, column 1 or 80/132).

**0 = draw the border**  
**1 = erase the border**

*bot* gives the bottom line of scrolling region.  
**Default = Bottom line of window.**

*copy* specifies the copy parameters of the command  
**0 = do not copy attributes**  
**1 = copy attributes to new window**

*dev* specifies the device to which the command applies  
**0 = requesting device**  
**1 = Port 1**  
**2 = Port 2**  
**3 = Port 3**  
**9 = Keyboard**

*dst* gives the number of destination window to be copied, values 1 to 6.  
**Default = 1** Windows must be identical in size and not overlapping. See *wnum*.

*eline* gives the ending line of memory for this window.  
**Default = 96.** Values 1 - 96, must be greater than *sline*.

*lft* gives the left edge of window.

**Default = 0 = Column 1.** Values 1 - 132, must be less than *rgt*.

*reset* reassigns factory definitions to all allocated windows.

**0 = reset all allocated windows to defaults**

*rgt* gives the right edge of window.

**Default = 0 = Column 80.** Values 1 -132, must be greater than *lft*.

*savres* specifies whether to save or restore current window number.

**0 = Save current window number**

**1 = restore saved window**

*sline* gives the starting line of memory for the window.

**Default = 1.** Values 1 - 96, must be less than *eline*.

*src* gives the number of source window to be copied.

**Default = 1,** values 1 - 6. Windows must be identical in size and not overlapping. See *wnum*.

*top* specifies the top line of scrolling region.

**Default = 1.**

*vport* specifies the viewport number.

**Default = 1,** values 1 to 6.

*wbot* gives the bottom line of window.

**Default = Last line of memory range.**

*win* specifies the window number relative to terminal.

**Default = 1,** values 1 - 6.

*wnum* is the window number relative to the device. The windows assigned to the device are numbered sequentially. For example, terminal windows 4, 5, and 6 assigned to Port 3 would have *wnum* = 1, 2, and 3.

**Default = 1.** Values 1 - 6.

*wpage* simulates HDS2200 operation by selecting the appropriate windows from the default window assignments of the HDS3200.

**0 = all of display memory (lines 1-96)**

**1 = first page (lines 1-24)**

**2 = second page (lines 25-48)**

**3 = third page (lines 49-72)**

**4 = fourth page (lines 73-96)**

**9 = message line (25th screen line)**

*wtop* gives the top line of window.

**Default = First line of memory range.**



## Screen Management Commands

---

Command Name	Setup	Command Sequence
Define Screen Range	HDS Exten	CSI <i>tline</i> ; <i>bline</i> ; <i>win</i> ; <i>nodrag</i> ; <i>restrict</i> + <i>w</i>
Scroll Line Down		CSI repeat T
Alternate		<u>Ctrl down arrow</u>
Scroll Line Up		CSI repeat S
Alternate		<u>Ctrl up arrow</u>
Page Screen Range Down		CSI repeat V
Alternate		<u>Shift down arrow</u>
Page Screen Range Up		CSI repeat U
Alternate		<u>Shift up arrow</u>
Set Top Of Screen		CSI <i>lin</i> ; <i>win</i> - <i>s</i>
Display Page Number		CSI <i>dpage</i> / <i>s</i>

---

### Parameters:

*bline* specifies the bottom line of screen range for current window.

**Default = 24 or 48** depending on current screen mode.

*dpage* specifies the top of screen. (For HDS2200 compatibility only)

- 1 = Line 1
- 2 = Line 25
- 3 = Line 49
- 4 = Line 73

*lin* specifies the line to set as top of screen

**Default = 1**

*nodrag* sets automatic scroll of window in screen range to keep cursor visible.

- 0 = drag on, cursor visible
- 1 = no drag

*repeat* specifies the number of times to repeat command.

**Default = 1.**

*restrict* sets the scrolling limitations for screen ranges

- 0 = Page/scroll/top of screen restricted to current window and viewport
- 1 = no restrictions

*tline* sets top line of screen range for current window.

**Default = 1**

*win* selects the window number

**Default = 1, values 1 - 6.**

## Terminal Status Commands

Command Name	Setup	Command Sequence
DEC-Private Terminal ID	Genl	CSI = 24 l
HDS-Private Terminal ID	Genl	CSI = 24 h
Transmit Terminal ID		CSI 0 c
Alternate		ESC Z
Transmit Device Status		CSI 5 n
Transmit Printer Status		CSI ? 15 n
Transmit UDK Status		CSI ? 25 n
Transmit Keyboard Language		CSI ? 26 n
Transmit Answerback Message		ENQ (CTRL E)
Alternate		<u>Ctrl Break</u>
Status Line		CSI <i>scrln;lintyp;vis</i> - r
Display Message Line		CSI = 29 h
Blank Message Line		CSI = 29 l
VT220 Firmware Request		CSI > c

### Notes:

(1) The response to terminal ID requests depends on selections from Setup Mode.

Transmitted Response	Setup Choice	Operating Mode
CSI ? 1 ; 2 c	VT100 ID	VT100 or VT200
CSI ? 1 ; 0 c	VT101 ID	VT100 or VT200
CSI ? 6 c	VT102 ID	VT100 or VT200
CSI ? 62; 1; 2; 6; 7; 8; 9 c	VT220 ID	VT200

If HDS Private Terminal ID is in effect (CSI = 24 h), the response depends on the terminal configuration and the firmware version number:

Transmitted response corresponds to the terminal type as follows:

CSI = 15 ; *ver*; *graph*; *apl*; *dlist* c

where *ver* gives the two-digit version number of the current HDS firmware (for instance version 1.0 is sent as 10);

*graph* gives the graphics capability of the terminal:

0 = no graphics capability (doesn't apply to HDS3200 series)

1 = medium resolution graphics (1056 x 400 pixels)

2 = high resolution graphics (1056 x 800 pixels)

*apl* gives the APL capability of the terminal

0 = no APL

1 = APL option

*dlist* gives the display list memory

0 = no display list memory

1 = 256 K

2 = 512 K

(2) Terminal response to Device Status request is: CSI 0 n.

- (3) Possible responses to Printer Status request:  
 Printer ready: CSI ? 10 n  
 Printer not ready: CSI ? 11 n  
 No printer: CSI ? 13 n
- (4) Terminal response to UDK Status request is:  
 UDK's unlocked: CSI ? 20 n  
 UDK's locked: CSI ? 21 n
- (5) Terminal response to Keyboard Language request is:  
 CSI ? 27;1 n (North American).
- (6) Terminal response to VT220 Firmware request is:  
 CSI ? 1;20;0 c.

**Parameters:**

*lintyp* specifies the line type to display.

- 0 = use current setting
- 1 = **Status Line**
- 2 = Message Line
- 3 = Toggle between Status and Message Lines

*scrln* sets the screen line where the Status/Message Line is displayed

- 1 = maximum, (line 25 or line 50)

*vis* controls the visibility of the Status Line.

- 0 = use current setting
- 1 = turn off line
- 2 = turn on line
- 3 = toggle between On/Off

Note: Use of this command is recommended instead of mode =29.

## APL Operating Mode Commands

---

Command Name	Setup	Command Sequence
Enter APL Mode *	UserPref	CSI = 26 h
Exit APL Mode *	UserPref	CSI = 26 l
Define APL Overstrikes *		CSI <i>apl;achr;bchr</i> /
Automatic APL Overstrike Storage Off *		CSI = 27 l
Automatic APL Overstrike Storage On *		CSI = 27 h

---

**Parameters:**

*achr;bchr* specifies the APL chart location for first/second characters of user defined overstrike pair.

- 0 - 31 = illegal characters

*apl* defines the the overstrike characters

- 0 = add overstrike pair
- 1 = return to factory settings
- 2 = display user-defined pairs

## User Defined Keys Keychart

This chart shows the key numbers and the factory settings of the User Defined Keys. The key numbers are used in other terminal commands for UDK's; refer to the *HDS3200 Programmer's Reference Manual*. The factory definitions are simply identification sequences for each key which have no direct application. CSI designates an 8 bit control code; its 7 bit equivalent is ESC [.

### Unshifted Keys (HDS UDK programming only)

Key Label	Number	VT220 Default	VT100/VT52 Default or Graphics
Find	101	Send <i>CSI 1</i> ~	Do Nothing
Insert Here	102	Send <i>CSI 2</i> ~	Do Nothing
Remove	103	Send <i>CSI 3</i> ~	Do Nothing
Select	104	Send <i>CSI 4</i> ~	Do Nothing
Prev Scrn	105	Send <i>CSI 5</i> ~	Do Nothing
Next Scrn	106	Send <i>CSI 6</i> ~	Do Nothing in graphics Clear screen, enter Alpha mode
F6	117	Send <i>CSI 17</i> ~	Do Nothing
F7	118	Send <i>CSI 18</i> ~	Do Nothing
F8	119	Send <i>CSI 19</i> ~	Do Nothing
F9	120	Send <i>CSI 20</i> ~	Do Nothing
F10	121	Send <i>CSI 21</i> ~	Do Nothing
F11	123	Send <i>CSI 23</i> ~	<i>Escape</i>
F12	124	Send <i>CSI 24</i> ~	<i>Backspace</i>
F13	125	Send <i>CSI 25</i> ~	<i>Line Feed</i>
F14	126	Send <i>CSI 26</i> ~	Do Nothing
Help	128	Send <i>CSI 28</i> ~	Do Nothing
Do	129	Send <i>CSI 29</i> ~	Do Nothing
F17	131	Send <i>CSI 31</i> ~	Do Nothing
F18	132	Send <i>CSI 32</i> ~	Do Nothing
F19	133	Send <i>CSI 33</i> ~	Do Nothing
F20	134	Send <i>CSI 34</i> ~	Do Nothing

## HDS3200 Owner's Manual

### Shifted Keys (DEC and HDS UDK programming)

---

Key Label	Number	VT220 Default	VT100/VT52 Default or Graphics
Find	1	Do Nothing	Do Nothing
Insert Here	2	Do Nothing	Do Nothing
Remove	3	Do Nothing	Do Nothing
Select	4	Do Nothing	Do Nothing
Prev Scrn	5	Do Nothing	Do Nothing
Next Scrn	6	Do Nothing	Do Nothing in graphics Clear screen, enter Alpha mode
F6	17	Do Nothing	Do Nothing
F7	18	Do Nothing	Do Nothing
F8	19	Do Nothing	Do Nothing
F9	20	Do Nothing	Do Nothing
F10	21	Do Nothing	Do Nothing
F11	23	Do Nothing	<i>Escape</i>
F12	24	Do Nothing	<i>Backspace</i>
F13	25	Do Nothing	<i>Line Feed</i>
F14	26	Do Nothing	Do Nothing
Help	28	Do Nothing	Do Nothing
Do	29	Do Nothing	Do Nothing
F17	31	Do Nothing	Do Nothing
F18	32	Do Nothing	Do Nothing
F19	33	Do Nothing	Do Nothing
F20	34	Do Nothing	Do Nothing

---

**Mouse/Digitizer Keys**

The mouse and digitizer keys are programmable like any other keys. In Setup Mode the Up position is selected by pressing the *Comp Char* key, then the desired key. The Down position is selected by pressing the key alone. These keys are executed immediately by the terminal. These keys may also be programmed by HDS escape sequences using key numbers 201 to 206.

---

Mouse Key Label	Key Number
Mouse R Up	201
Mouse R Down	202
Mouse Center Up	203
Mouse Center Down	204
Mouse L Up	205
Mouse L Down	206

---

In GIN Mode of graphics the factory definitions for all three keys change the tracking ratio for the mouse, by a factor of 2 for the Up definition and a factor of 1/2 for the Down definition. The key activity is registered on the transition from Up to Down or vice versa, not the final state.

---

Key	Key Action
Mouse Button Up	1:1 Mouse:Screen
Mouse Button Down	1:2 Mouse:Screen

---

In normal graphics operation the mouse key definitions are to enter or exit Zoom, Pan, and Draw modes. The modes are selected by a normal keystroke, press and release.

---

Key	Key Action
Mouse Right	Enter/exit Pan Definition Mode
Mouse Middle	Execute Draw Function
Mouse Left	Enter/exit Zoom Definition Mode

---

In Setup Mode the mouse key definitions are as shown. For Tab editing in Setup Mode, the Left and Right keys toggle the tab setting and the Middle key exits the Tab editing field.

---

Key	Key Action
Mouse Right	Select Previous Field Option
Mouse Middle	Select Next Setup Menu
Mouse Left	Select Next Field Option

---

**Cursor/Numeric Pad**

The mode of operation of the Cursor and Numeric Keypads depends on the settings chosen in Setup Mode. The definitions in the chart shown for each operating mode are sent when the key is pressed. CSI is an 8 bit control code; its 7 bit equivalent is ESC [. SS3 is also an 8 bit control code; its 7 bit equivalent is ESC O (uppercase o, not zero).

**Cursor Pad Transmission**

---

Key	VT220/VT100 Mode		VT52 Mode	
	Normal Mode	Application Mode	Normal Mode	Application Mode
Up arrow	CSI A	SS3 A	ESC A	ESC A
Down arrow	CSI B	SS3 B	ESC B	ESC B
Right arrow	CSI C	SS3 C	ESC C	ESC C
Left arrow	CSI D	SS3 D	ESC D	ESC D

---

**Numeric Pad Transmission**

---

Key	VT220/VT100 Mode		VT52 Mode	
	Normal Mode	Application Mode	Normal Mode	Application Mode
0	0	SS3 p	0	ESC ? p
1	1	SS3 q	1	ESC ? q
2	2	SS3 r	2	ESC ? r
3	3	SS3 s	3	ESC ? s
4	4	SS3 t	4	ESC ? t
5	5	SS3 u	5	ESC ? u
6	6	SS3 v	6	ESC ? v
7	7	SS3 w	7	ESC ? w
8	8	SS3 x	8	ESC ? x
9	9	SS3 y	9	ESC ? y
Minus	-	SS3 m	-	ESC ? m
Comma	,	SS3 l	,	ESC ? l
Period	.	SS3 n	.	ESC ? n
Enter	CR	SS3 M	CR	ESC ? M
PF1	SS3 P	SS3 P	ESC P	ESC P
PF2	SS3 Q	SS3 Q	ESC Q	ESC Q
PF3	SS3 R	SS3 R	ESC R	ESC R
PF4	SS3 S	SS3 S	ESC S	ESC S

---

## Terminal Processing Modes

The **Boldface** entry indicates the mode's factory setting.

Mode Number	Processing Mode	Reset State	Set State
<b>ANSI Processing Modes</b>		<b>CSI <i>ansimode</i> 1</b>	<b>CSI <i>ansimode</i> h</b>
2	Keyboard Lock	<b>Unlocked</b>	Locked
4	Replace/Insert Characters	<b>Replace</b>	Insert
12	Local Echo	<b>Yes</b>	No
20	Line Feed Processing	<b>Line Feed</b>	New Line
<b>HDS Private Processing Modes</b>		<b>CSI = <i>hdsmode</i> 1</b>	<b>CSI = <i>hdsmode</i> h</b>
=21	Clear Screen On 80/132 Change	<b>Yes</b>	No
=22	On-Line/Local	<b>On-Line</b>	Local
=23	Form Feed Processing	<b>Line Feed</b>	Clear Window
=24	Terminal ID	<b>DEC-Private</b>	HDS-Private
=25	Display/Blank Inactive Memory	<b>Display</b>	<b>Blank</b>
=26	ASCII/APL	<b>ASCII</b>	APL
=27	Auto APL Overstrikes	<b>No Overstrikes</b>	<b>Overstrikes Stored</b>
=28	Character Set Expansion	<b>DEC (Expanded)</b>	HDS (No Expansion)
=29	Display Status/Message Line	<b>Blank 25/50th Line</b>	Display 25/50th Line
=30	Alternate Graphics Exit Char.	<b>None</b>	Ctrl F
=31	Graphics Resolution *	<b>Medium (400)</b>	High (800)
=32	Screen Lines (25/50) *	<b>25 lines</b>	50 Lines
=33	UDK Sets (1/3)	<b>1 UDK Set</b>	3 UDK Sets
=34	Setup Key	<b>Enabled</b>	Disabled
=35	HDS Extensions	<b>Disabled</b>	<b>Enabled</b>
=36	Automatic Graphics Entry	<b>Disabled</b>	<b>Enabled</b>
<b>DEC Private Processing Modes</b>		<b>CSI ? <i>decmode</i> 1</b>	<b>CSI ? <i>decmode</i> h</b>
?1	Cursor Keypad Operation	<b>Normal</b>	Application
?2	ANSI/VT52 Mode	<b>VT52</b>	ANSI
?3	Display Width	<b>80 Columns</b>	132 Columns
?4	Smooth Scroll	<b>Jump Scroll</b>	Smooth Scroll
?5	Screen Video	<b>Normal</b>	Reverse
?6	Cursor Addressing	<b>Window</b>	Scrolling-Region
?7	Auto Wrap	<b>No</b>	Yes
?8	Auto Repeat	<b>No</b>	Yes
?18	Print Termination	<b>None</b>	<b>Form Feed</b>
?19	Print Extent	<b>Scrolling Region</b>	<b>Window</b>
?25	Text Cursor	<b>Off</b>	<b>On</b>
?38	Enter Graphics	<b>Exit Graphics</b>	Enter 4014 Mode
?43	Graphics Print	<b>Compressed</b>	<b>Normal</b>
?66	Numeric Keypad	<b>Numeric Keypad</b>	Application Mode
?73	Limit Transmit Rate	<b>No</b>	Yes



## Graphics Mode Command Listing

Graphics terminal commands are either control codes or command sequences. They are compatible with Tektronix 4010/4014 commands and operate with 7 data bit communications. Commands are shown in their 7 bit form as Escape sequences rather than 8 bit control codes.

Command sequences are shown with the following conventions:

**ESC** stands for the Escape control code (ASCII 027).

**CTRL** indicates a control code (ASCII 0 -31)

**Sp** indicates a space character (ASCII 032)

*italics*: indicate command parameters

i>

**bold**: indicates default values for parameters

**\***: indicates a command available only with a terminal option

After an Escape character is received, CR and LF characters are ignored until a complete, valid escape sequence is received. Sometimes CR or LF characters are included automatically as part of graphic transmissions; if such a character is received during an escape sequence, it is ignored.

## General Graphics Commands

Command Name	Setup	Command Sequence
Enter Vector Mode		GS (CTRL J)
Enter Point Plot Mode		FS (CTRL \)
Enter Incremental Point Plot Mode		CTRL ^ <i>pen</i>
Enter Graphics, Alpha Mode, Clear Memory		ESC CTRL L
Enter Graphics (Keyboard only)		<i>Text Graph</i>
Alpha Mode - Clear Memory		<i>Ctrl Text Graph</i>
Enter 4014 Mode		ESC [ ? 38 h
Exit Graphics, Enter 220, 7bit Mode		ESC [ ? 38 l
Exit Graphics		CAN (CTRL X)
Alternate		ESC " 0 g
Alternate		<i>Shift Text Graph</i>
Enable Automatic Graphics Entry		ESC [ = 36 h
Disable Automatic Graphics Entry		ESC [ = 36 l
No Alternate Graphics Exit Character		ESC [ = 30 l
Ctrl F Alternate Graphics Exit Character		ESC [ = 30 h
Bell		BEL (CTRL G)
Delay Character		NUL (CTRL @)
Alternate		SYN (CTRL V)
Alternate		ESC CTRL V
Transmit Status		ESC CTRL E
Select Medium Resolution *	Graph	ESC [ = 31 h
Select High Resolution *	Graph	ESC [ = 31 l
Port 3/Mouse Control	Comm	ESC [ <i>port3;track;active / z</i>

**Parameters:**

*active* determines when the mouse is active

- 0 = mouse is active in Graphics and Setup Modes only
- 1 = mouse is active in Graphics, ANSI, and Setup Modes

*pen* gives the drawing (pen down) or non-drawing (pen up) movement of incremental point plot mode.

- Sp = Pen up
- P = Pen down

*port3* selects the type of input for port 3

- 0 = Normal (RS-232) port
- 1 = HDS Mouse
- 2 = MM1201 (full pad) Digitizer
- 3 = MM1201 (partial pad) Digitizer
- 4 = MM961/MM1812 Digitizer
- 5 = Bit Pad One Digitizer

*track* is the tracking ratio of the mouse, (ratio = mouse:screen movement)

- 0 = 1:2
- 1 = 1:1
- 2 = 2:1
- 3 = 4:1

## Screen Memory Commands

Command Name	Setup	Command Sequence
Screen Video - Fill Screen		ESC X
Screen Video - Complement Screen		ESC Y
Clear Graphics Memory		CTRL Y
Alternate		ESC CTRL Y
Alpha Page Full (Hold/Clear)	Graph	
Select Medium Resolution Page *	Graph	ESC / <i>wbank;dbank g</i>
Memory Dump		ESC P = <i>r</i>
Memory Load		ESC P <i>q sixels</i> ESC \
Memory Load (HDS)		ESC P = <i>q sixels</i> ESC \
Binary Block Transfer *	ESC /	<i>srcx;srcy;delx;dely;destx;desty;oper C</i>
Graphics Memory - Nondisplay		ESC CTRL R
Graphics Memory - Display		ESC CTRL T
Blank ANSI/Graphics Screen		ESC [ <i>blank / v</i>
Display Currently Inactive Memory	Graph	ESC [ = 25 <i>l</i>
Blank Currently Inactive Memory	Graph	ESC [ = 25 <i>h</i>
Write/Display Offset		ESC / <i>writeoff;dispoff w</i>

**Parameters:**

*blank* selects the memory group for display or blanking

- 0 = unblank alpha memory**
- 1 = blank alpha memory
- 2 = unblank graphics memory
- 3 = blank graphics memory

*dbank* selects the page of screen memory to display

- 0 = page 1**
- 1 = page 2

*delx,dely* Delta (x,y) gives the change from the origin coordinate to specify the size of the binary block rectangle.

**Default = 0,0**

*destx,desty* Destination rectangle origin coordinate (x,y)

**Default = 0,0**

*dispoff* Display offset of graphics screen memory

- 0 = offset is scan line 0**
- values up to 192 are valid

*oper* The logical operand to be performed on the destination rectangle:

- 0 = Source to Destination**
- 1 = NOT Destination
- 2 = NOT Source
- 3 = Source OR Destination
- 4 = Source XOR Destination
- 5 = Source AND Destination
- 6 = 0's: destination is set to all 0's
- 7 = 1's: destination is set to all 1's

*sixels* Data encoded as groups of sixels

*srcx,srcy* Source rectangle origin coordinate (x,y)

**Default = 0,0**

*wbank* selects the page of screen memory to write to

- 0 = page 1**
- 1 = page 2

*writeoff* Write offset of graphics screen memory

- 0 = write offset is scan line 0**
- values up to 192 are valid

## Graphics Printing Commands

Command Name	Setup	Command Sequence
Print Graphics Memory		ESC CTRL W
Alternate		<u>Print Scrn</u>
Normal Graphics Print		ESC [ ? 43 h
Compressed Graphics Print		ESC [ ? 43 l
Set Printer Buffer *		ESC [ <i>bufsize</i> - p

### Parameters:

*bufsize* selects the size of memory block used for the printer buffer

0 = no printer buffer

64 = allocate 64K bytes for printer buffer

128 = allocate 128K bytes for printer buffer

## Graphics Mode Changing Commands

Command Name	Setup	Command Sequence
Alpha Mode; CR		CR (CTRL M)
Alpha Mode; No Movement		US (CTRL _)
Alpha Mode; Clear Memory		ESC FF (CTRL L)
Alternate; from keyboard		<u>CTRL Text Graph</u>
Alternate; from keyboard		<u>Next Scrn</u>
Vector Mode		GS (CTRL J)
GIN Mode		ESC CTRL Z
Alternate		ESC " 4 g
Alternate		ESC " 5 g
Point Plot Mode		FS (CTRL \)
Incremental Point Plot Mode		RS (CTRL ^)
Special Point Plot Mode		ESC FS (CTRL \)

## Graphics Alpha Mode Commands

Command Name	Setup	Command Sequence
ASCII Character Set		ESC CTRL O
APL Character Set *		ESC CTRL N
Cursor Up		VT (CTRL K)
Cursor Down		LF (CTRL J)
Cursor Left		BS (CTRL H)
Cursor Right		HT (CTRL I)
Alternate		Sp
Carriage Return		CR (CTRL M)

Alpha Page Full (Hold/Clear)	Graph	
Space Processing		
Non-destructive Space		ESC / 2 1
Destructive Space		ESC / 2 h
Backspace Processing		
Non-destructive Backspace		ESC / 9 1
Destructive Backspace		ESC / 9 h
Carriage Return - Line Feed Processing		ESC / <i>newline s</i>
Character Set Sizes		
Normal		ESC 8
Alternate		ESC 0
Small		ESC 9
Smaller		ESC :
Smallest		ESC ;
2x (two times)		ESC 1
3x (three times)		ESC 2
4x (four times)		ESC 3
Rotation of Characters		ESC / <i>rot e</i>
Slanted Characters		ESC <
Do Not Slant Characters		ESC =

---

**Parameters:**

*newline* selects the CR and LF processing format

- 0 = Normal CR and LF
- 1 = Auto CR (CR = CR/LF)
- 2 = Auto LF (LF = CR/LF)
- 3 = Auto CR/LF (CR and LF = CR/LF)

*rot* selects the rotation direction

- 0 = rotate 270 degrees
- 2 = rotate 0 degrees
- 4 = rotate 90 degrees
- 6 = rotate 180 degrees

**Graphics Vector Mode Commands**

---

Command Name	Setup	Command Sequence
Draw Vector or Block	(1)	<i>address</i>
Reposition Vector Cursor		GS (CTRL J)
Draw Rectangle		ESC / <i>xhom;yhom;dx;dy</i> x
Fill Patterns		
Solid		ESC @
Gray		ESC A
Left to Right Slant		ESC B
Right to Left Slant		ESC C
Horizontal Lines		ESC D
Vertical Lines		ESC E
Slanted cross-hatch		ESC F
Vertical cross-hatch		ESC G
Checkerboard		ESC H

## HDS3200 Owner's Manual

Dotted		ESC I
Horizontal herringbone		ESC J
Vertical herringbone		ESC K
Draw And Fill Rectangle		ESC / <i>xhom;yhom;dx;dy;fill y</i>
Rotation of Rectangles		ESC / <i>rot e</i>
Vector Draw Mode		ESC CTRL C
Block Fill Mode		ESC CTRL B
Line Feed		LF (CTRL J)
Data Level		ESC / <i>data d</i>
Vector Line Type		
Normal	(2)	ESC ‘
Dotted	(3)	ESC a
Dot-Dashed	(4)	ESC b
Short-Dashed	(5)	ESC c
Long-Dashed	(6)	ESC d
User-Defined-1		ESC x
User-Defined-2		ESC y
User-Defined-3		ESC z
Define Line Types		
Define User 1		ESC / <i>ptrn a</i>
Define User 2		ESC / <i>ptrn b</i>
Define User 3		ESC / <i>ptrn c</i>
Arc/Circle Draw		ESC / <i>x;y;R;T;P A</i>
Arc/Circle Draw and Fill		ESC / <i>x;y;R;T;P;fill B</i>

---

### Notes:

(1) This command positions the vector cursor and draws a vector or fills a block from the previous cursor position. If this is the first time an address is received after CTRL J (command to enter Vector mode), the vector cursor assumes that address location, but nothing is drawn or filled.

(2) Alternates for ‘ (ASCII 96) are e (101), f (102), g (103), h (104), m (109), n (110), o (111), p (112), u (117), v (118), and w (119).

(3) Alternates for a (ASCII 97) are i (105) and q (113).

(4) Alternates for b (ASCII 98) are j (106) and r (114).

(5) Alternates for c (ASCII 99) are k (107) and s (115).

(6) Alternates for d (ASCII 100) are l (108) and t (116).

### Parameters:

*address* is a four character sequence giving the cursor position as follows:

HI-Y is the character whose location in the ASCII chart is equal to 32 plus the integer determined by dividing the Y address by 32 and truncating the decimal. ASCII [32 + INT (Y/32)].

LO-Y is the character whose location in the ASCII chart is equal to 96 plus the remainder after 32 is divided into the Y address. ASCII [96 + MOD (Y,32)].

HI-X uses the same procedure as HI-Y except uses the X address. ASCII [32 + INT (X/32)].

LO-X uses the same procedure as LO-Y except uses the X address and adds the result to 64. ASCII [64 + MOD (X,32)].

Note that the order of the address is given as Y, X and that the characters are transmitted in the sequence given (HI-Y, LO-Y, HI-X, LO-X). The vector cursor home position (X=0, Y=0) is in the lower left corner of the display.

*data* specifies the data level

- 0 = White (draw) data level.  
Alternate command is ESC CTRL A.
- 1 = Black (erase) data level.  
Alternate command is ESC CTRL P.
- 2 = Complement data level.  
Alternate command is ESC CTRL U.
- 3 = Replace data level.

*dx* and *dy* specify the width and height, respectively, of the rectangle.

Note that these parameters are number increments to the *xhom* and *yhom* parameters, not independent addresses. Accepted values are numbers 1 to 1024 and 1 to 795 respectively.

Default = 0,0

*fill* specifies the fill pattern for the rectangle.

- 0 = use current fill pattern
- 1 = Solid
- 2 = Gray
- 3 = Left to Right Slant
- 4 = Right to Left Slant
- 5 = Horizontal Lines
- 6 = Vertical Lines
- 7 = Slanted Cross-hatch
- 8 = Vertical Cross-hatch
- 9 = Checkerboard
- 10 = Dotted
- 11 = Horizontal Herringbone
- 12 = Vertical Herringbone
- 13, 14, 15 = Border without Fill

*P* specifies the length of the arc to be drawn, given in degrees. Either 0 or 360 degrees specify a complete circle. Default = 0.

*ptrn* is a decimal number between 0 and 65,535 which, when expressed in binary form, supplies the pattern for the definition of the line. For example, *ptrn* = 28527 defines the line pattern:

0110 1111 0110 1111

This line pattern is displayed on the screen in reverse order, that is, the least significant bits of the number begin the pattern, so in this example, the line would be dash-dot-dash-dot.

*R* specifies the radius of the circle, given in tekpoints.

Default = 0

*rot* selects the rotation direction

- 0 = rotate 270 degrees
- 1 = rotate 0 degrees
- 2 = rotate 90 degrees
- 3 = rotate 180 degrees

*T* specifies the starting point of the arc to be drawn, given in degrees, with 0 degrees being due East. **Default = 0.**

*x, y* specify the coordinates of the center of the circle, given in tekpoints.  
**Default = 0,0**

*xhom* and *yhom* specify the coordinates of the lower left corner of the rectangle. Accepted values are address numbers  $x = 0$  to 1023 and  $y = 0$  to 795. **Default = 0.**

## Graphics Point Plot Mode Commands

---

Command Name	Setup	Command Sequence
<b>Point Plot Mode</b>		
Reposition Point Plot Cursor		CTRL \ <i>address</i>
Plot A Point		<i>address</i>
<b>Incremental Point Plot Mode</b>		
Enter Incremental Point Plot Mode		CTRL ^ <i>pen</i>
Pen Up		Sp
Pen Down		P
Move East		A
Move West		B
Move North		D
Move Northeast		E
Move Northwest		F
Move South		H
Move Southeast		I
Move Southwest		J
<b>Special Point Plot Mode</b>		
Reposition Special Point Plot Cursor		ESC CTRL \ <i>intens address</i>
Plot A Point		<i>intens address</i>

---

### Parameters:

*address* Refer to Vector Mode addressing

*intens* specifies the intensity of the tekpoint at the address location. This is accepted but not used by HDS3200 Series graphics terminals.

*pen* gives the drawing (pen down) or non-drawing (pen up) movement of incremental point plot mode.

- Sp = Pen up
- P = Pen down



## GIN Mode (Graphical Input) Commands

Command Name	Setup	Command Sequence
Enter GIN Mode		ESC SUB (CTRL Z)
Alternate		ESC " 4 g
Alternate		ESC " 5 g
Crosshair Movement		<u>arrow keys</u>
GIN Cursor Size		ESC / cursiz W
Transmit Crosshair Address		<i>char</i>
Transmit Status		ESC ENQ (CTRL E)
Enter Alpha Mode; Clear Memory		ESC FF (CTRL L)
Alternate		<u>Next Scrn</u>
Exit GIN Mode; enter ANSI mode		<u>Shift Text Graph</u>
Load Crosshair Position		ESC / f
Crosshair Address/Status Terminator		ESC / term t

### Notes:

- (1) Keyboard arrow keys should be used for GIN mode cursor movement when the mouse or digitizer tablet options are not installed. Shifted arrow keys move multiple lines or columns with a single keystroke.
- (2) After transmitting the terminal status, data is ignored until one of the following command sequences is received: CTRL G, CTRL J, CTRL M, CTRL O, CTRL ], CTRL \_\_, ESC CTRL E, ESC CTRL L, ESC CTRL W, and ESC CTRL Z. This character is also processed.
- (3) The characters transmitted are a one-character terminal status indicator, the four-character GIN address, followed by a programmable status terminating character (default is CR, ASCII 013). Terminal status characters are not transmitted in GIN mode. The terminal status character is given in the following form, with the bit designations as follows:

Bit 7 6 5 4 3 2 1 0  
 P 0 1 0 x x x x where

- Bit 7 = Parity, if used.
- Bit 6 = Always 0.
- Bit 5 = Always 1.
- Bit 4 = Availability of printer; terminal always assumes it is available, so Bit 4 is always 0.
- Bit 3 = 1 if in Vector mode; 0 for other modes.
- Bit 2 = 1 if in Alpha mode; 0 for other modes.
- Bit 1 = 1 if in Margin 2 of Alpha mode; 0 if in Margin 1.
- Bit 0 = 0 for Special Point Plot mode or Incremental Point Plot mode; 1 for other modes.

The status byte is transmitted as the corresponding ASCII character.

**Parameters:**

*char* is the GIN mode address of (x,y), composed of four ASCII characters:

- HI-X = ASCII [ 32 + INT (x/32) ]
- LO-X = ASCII [ 32 + MOD (x,32) ]
- HI-Y = ASCII [ 32 + INT (y/32) ]
- LO-Y = ASCII [ 32 + MOD (y,32) ], transmitted in the sequence given.

*cursiz* is the size of the GIN crosshair cursor

- 0 = small cursor
- 1 = large cursor (full destination rectangle size)

*term* specifies the GIN mode terminating character

- 0 = CR
- 1 = no terminating character
- 2 = CR, EOT
- 3 = CR, LF

## Graphics Zoom/Pan Mode Commands

---

Command Name	Setup	Command Sequence
Set X/Y Zoom Factor *		ESC / <i>zoomx;zoomy</i> X
Start/Stop Data Logging *	Graph	ESC / <i>onoff</i> L
Graphics Quadrants *	Graph	ESC / <i>quad</i> Q
Select Display List *	Graph	ESC / <i>dispnum;dlist</i> S
Redraw Display List *		ESC / <i>redraw</i> Z
Define Destination Rectangle *		ESC / <i>orgx;orgy;delx;dely</i> D
Define Source Origin *		ESC / <i>orgx;orgy</i> O
Clear Screen/Destination Rectangle *		ESC / <i>clear</i> E

---

**Parameters:**

*clear* specifies the clear screen function desired; display lists are unaffected.

- 0 = Clear screen and destination rectangle.
- 1 = Clear only destination rectangle.

*delx, dely* Delta (x,y), values 1 to 1023, the incremental increase from the origin which defines the size of the destination rectangle.

**Default values are the boundaries of the entire screen.**

*dispnum* Number of the current set of display factors, 1 to 4.

**Default = Set 1**

*dlist* Number of the current display list, 1 to 4.

**Default = *dispnum* = 1**

*onoff* specifies the data logging setting

- 0 = data logging off for current display list.
- 1 = data logging on, current display list settings apply.

*orgx, orgy* Origin (x,y) coordinate, lower left corner, used to define the destination or source rectangle, values 0 to 1023.  
**Default values are 0,0.**

*quad* specifies quadrant mode operation  
**0 = quadrant mode off**  
**1 = quadrant mode on**

*redraw* selects the type of redraw function  
**0 = redraw with current zoom factors and rectangles**  
**1 = redraw with "times 1" parameters**

*zoomx* specifies the zoom factor for x.  
**Default = 1** Values 1 to 16 increase the magnification (1x to 16x).  
Values 101 to 116 decrease the magnification (1x to 1/16x).

*zoomy* specifies the zoom factor for y.  
**Default = zoomx value.**  
Permitted values are the same as for *zoomx*.

## Index

Entries in the Index which appear in *underlined italics* designate keyboard keys. Listings which appear in **bold type** designate locations where a definition or important treatment of the entry item can be found.

- Alternate Processing Mode 12-1
- Anadex DP 9620 Printer Connections 2-12, 5-3, 13-17
  - See also* Printer Connections
- Anisotropic Zoom Factor 2-15, 7-5, 8-7, 8-8, 9-5, 9-6, **12-1**
- ANSI Mode Operation 3-4, 5-1, 7-3, 7-4, 12-1, 13-22
- Answerback Message 1-8, 2-13, 7-4, **12-1**
  - See also* Edit Answerback Message, Concealed Answerback Message
- APL *See* **Appendix D**, 12-1, 13-6, 13-22
  - in Setup Mode 2-7
  - Character Set 3-9, 13-6, 13-22
    - See also* Character Set
  - Overstrike Characters 13-22
- APL/ASCII mode 2-7, 13-22
- Application Mode (Numeric Keypad) 2-10, 12-1
- Application Programs 4-1, 5-1, 8-10, 12-1
- ASCII Character Set 2-7, 3-9, 12-1, 13-6, 13-22
  - See also* Character Set
- Auto Print Mode 1-8
- Auto Repeat Mode 1-11, 2-12
- Autowraparound 2-5, 2-7, 12-1
  
- Back Space* 1-6, 6-2
- Baud Rate 3-4, 3-6, 3-7, 12-1
- Bell Volume 2-11, 12-2
  - See also* Margin Bell, Warning Bell
- Break* 1-8, 1-11, 2-11, 12-2
- Brightness/Contrast Controls 1-1, 1-4, 11-2
  
- Calculator 3-6, **Chapter 6**, 12-2
  - See also* On-screen Calculator
- Caps/Shift Lock* 1-5, 1-6, 1-11, 2-11, 4-1, 12-4
- Character Set 2-7, 3-9, 11-4, 12-2, 13-6 through 13-10, 13-22
  - See also* ASCII Character Set
- Character Size (7/8 Bit ANSI Operating Mode) 3-5, 3-8
  - See also* ANSI Mode Operation
- Character Size (Data Bits) 3-5, 3-8, 12-2
- Checking Out The Terminal 1-3, 11-3, 11-4
  - See also* Terminal Self Tests
- C. Itoh Printer 2-12, 5-3, 13-16
  - See also* Printer Connections
- Cmd (Shift Esc)* 1-7, 4-3, 12-2
- Clear Communications Ports 2-4, 5-4, 5-7, 7-2
- Clear Graphics Display 2-12, 5-2, 9-2
- Clear Screen On 80-132 Change 2-7

- Clear Text Display 2-4
- Clipping Operations **Chapter 9, 12-2**
- Columns Displayed 2-6, 2-14
- Command Sequence 4-3, **12-3**
- Communications *See Chapter 4*
  - Considerations 2-8, 3-1, 5-1, 5-6, 7-2, 10-1, 11-3
  - Lines and Devices 2-8, 3-1, 3-3, 7-2, 10-1
  - Self Test 11-4
  - Settings *See Chapter 4*
  - Setup Menus 2-8, 2-9, 3-8
  - Status 2-4
- Communications Protocol 3-1, 3-4, 3-5, 3-6, **12-5**  
*See also* CTS Protocol, XON/XOFF Protocol
- Comp Char 1-7, 1-11, 2-11, 4-3, 6-1, 7-4, 7-5, **Chapter 8, 12-2, Appendix A**
- Control Codes 2-5, **12-2, 12-3**
  - 7 bit 3-5, 3-8
  - 8 bit 3-5, 3-8
- Control Code Processing 2-5, **12-3**
- Concealed Answerback Message 2-11
- Ctrl 1-7
- CTS Protocol 3-1, 3-2, 3-6, 3-7, **12-3**
- CTS Needed For Transmit 3-7
- Current Loop Interface 3-12
- Cursor
  - Blink 2-7
  - Control 2-7, **12-3**
  - Form 2-7
  - Position 2-15, **12-3**
- Cursor Always Visible 2-14, 10-6
- Cursor Keypad 1-10, 1-11, 3-10, 4-8, **12-3**
- Cursor Keypad Mode 1-10, 2-12
  
- Data Bits 3-7, 3-9, **12-3** *See* Character Size
- Data Logging 2-13, 2-15, 5-2, 5-4, 8-1, **Chapter 9**
- DEC LA75 Printer Connections 2-12, 5-3, 13-13  
*See also* Printer Connections
- DEC LA50 Printer Connections 13-14  
*See also* Printer Connections
- DEC Multinational Character Set *See* Multinational Character Set
- DEC Special Graphics Character Set 3-9, 13-7, 13-12
- DEC Technical Character Set 3-9, 13-8, 13-12, 13-22
- Default **12-3**
  - Communications Port Settings 3-6
  - Factory Settings **12-3**  
*See also* Reset NVM to Factory Defaults
  - User Defined Keys 4-4, 4-5, 4-6, 4-7, 4-8
- Define Window 2-14, **Chapter 10**
- Del 1-7, 6-2, **12-3, 13-1**
- Destination Rectangle 2-15, 9-6, **12-4**
- Digitizer Tablet 3-10, 5-3, 5-5, 5-6, 5-7, 7-2, **12-3**
  - Buttons 4-3, 4-6, 5-5, 5-7
  - Setup 3-10, 5-3, 5-5, 5-7
- Display Controls Mode 2-5
- Display Factors Number (Graphics) 2-15, 9-5

Display List 2-15, 5-4, 8-1, **Chapter 9**, 12-4  
Display List Memory 2-13, 2-15, 5-4, 5-5, **Chapter 8**, 9  
Display Memory 2-7, 2-15, 5-1, **Chapter 10**, 12-4  
Display Width 2-6, 2-15, 10-2  
Displayed On Screen Line 2-14, 10-2, 10-5, 10-6  
Do 1-7, 1-9, 2-1, 6-2  
down arrow 1-10, 2-2, 8-2  
Downline Loadable Character Set 13-20, 13-21  
    *See also* Character Set  
Draw Function 5-2, **Chapter 8**, 12-4  
DTR (Data Terminal Ready) Line 3-2, 3-3  
Duplex (Full/Half) Mode Processing 3-4, 3-8, 12-4  
    *See also* Local Echo

Edit Answerback Message 2-11  
Edit Individual Tab Stops 2-6  
Editing 12-3  
Enter 1-7, 1-9, 2-6, 6-1, 10-2, 12-4  
    *See also* Return  
Epson FX80 Printer Connections 2-12, 5-3, 13-15  
    *See also* Printer Connections  
Esc 1-7, 4-1, 12-4

50-line Mode 1-2, 2-7, 2-14, 7-4, 10-5, 10-6, 10-8  
Form Feed Processed As 2-7  
Fuse 1-5, 11-2

General Setup Menu 2-4  
GIN (Graphical Input) Mode Operation 1-10, 5-4, 5-5, 7-5  
GIN Mode Terminator 2-13, 5-3  
GIN Mouse Operation 4-3, 4-4, 4-7, 5-5, 5-6, 7-5  
Graphics Mode *See* **Chapter 5**, **8**, **9**, 12-4  
    - Alpha Mode Operation 5-4, 5-5  
    - Communications 5-1, 7-2, 7-3  
    - Compatibility 1-1, 5-1  
    - Exit Character 5-3  
    - Function Keys 5-2, 5-6, 5-7  
    - Margins 2-13, 5-4, 5-5  
    - Operation 1-2, 3-10, **Chapter 5**, 12-4  
    - Page Selection 2-13, 5-4, 9-1  
    - Self Test 11-4, 13-11  
Graphics Page Full/Clear 2-13, 5-4, 5-5  
Graphics Printer Selection 2-12, 5-3, **Appendix C**  
Graphics Quadrants 2-13, 5-4, 8-1, **Chapter 9**, 12-4  
Graphics Resolution 1-2, 2-12, 5-1, 5-3  
Graphics Setup Menu 2-12, 5-3  
Graphics Status Line 2-15, 9-5, 13-22  
Graphics/Text Screen Overlay 2-12, 5-3  
Graphics Zoom and Pan Operation 1-2, **Chapter 8**, 9

## HDS3200 Owner's Manual

- Help 1-7, 1-9, 2-1, 6-2
- HDS3200 Manuals v, 1-2
- HDS3200 Models 1-2
- HDS Extensions Setup Menu 2-13, 10-2
- Hold Scrn 1-9, 2-13, 5-4, 5-5, 8-10, 12-5
- Host Computer Is On Port 2-14, 10-1, 10-2, 10-4, 10-6
- Host Port 2-4, 2-14, 2-15, 3-2, 10-1, 10-4, 12-5
- HP LaserJet II Printer Connections 2-12, 5-3, 13-21
  - See also* Printer Connections
- HP Thinkjet Printer Connections 2-12, 5-3, 13-20
  - See also* Printer Connections
  
- IDS Prism Printer Connections 13-19
  - See also* Printer Connections
- Insert Here 5-2, 9-2
- Insert Mode *See* Replace/Insert Mode
- Inverse Video 12-5, *See* Reverse Video, Screen Display
  
- Joystick Connector 1-3, 1-5
  
- Keyboard 1-3, 1-5 through 1-11, 2-10, 12-5
  - Connection 1-3, 1-4
  - Groups 1-5 through 1-11
  - Illustrations 1-5, 1-6, 1-8, 1-9, 1-10, 2-1, 4-1, 6-2, 8-1
- Keyboard Setup Menu 2-10
- Keyclick Volume 1-11, 2-11, 12-5
  
- LED (Light Emitting Diode) 1-5, 11-2, 12-5
- left arrow 2-1, 2-2, 2-6, 4-2, 8-8, 10-2
- Limit Transmit Rate 3-6, 3-7, 3-8
- Line Feed 1-6, 3-4, 4-2, 12-5
  - See also* New Line
- Lines Displayed 2-7
- Local Echo 3-4, 3-6, 3-8, 12-4
  - See also* Duplex (Full/Half) Mode Processing
- Local Mode Processing 3-4, 12-5
- Local Operation Keypad 1-7, 4-5
- Lock 1-6, 1-11, 2-11, 4-1, 12-5
  
- Maintenance 7-1, **Chapter 11**
- Main Keypad 1-6, 4-5
- Margin Bell 1-11, 2-7
- Message Line 2-15
- Mouse 3-10, 5-2, 5-5, 5-6, **Chapter 7**, 12-5
  - Active Selection 3-10, 7-3
  - Buttons 2-3, 4-1, 4-3, 4-7, 5-5, 5-6, 7-3
  - In Setup Mode 2-3, 3-10, 3-11, 4-7, 7-4
  - In Zoom/Pan Mode 7-5, 8-7
  - Setting Up 3-10, 3-11, 5-6, 7-1, 7-2, 7-3, 11-1
  - Tracking Ratio 4-4, 4-7, 7-3, 7-4, 12-7

Multinational Character Set 3-9, 4-3, **Appendix A**, 13-9, 13-11, 13-12  
Multiple Computer Applications 2-13, 2-14, **Chapter 10**

Network 12-5, *See* Multiple Computer Applications  
New Line 2-7, 3-4, 4-1, 12-5  
*See also Return, Line Feed*  
*Next Scrn* 1-10, 2-13, 5-2, 5-3, 5-5, 8-2  
Numeric Keypad 1-7, 1-11, 2-11, 4-8, 6-1  
Numeric Keypad Mode 1-11, 2-11  
NVM 2-1, 2-2, 2-5, 2-11, 2-12, 3-5, 3-6, 4-2, 4-3, 12-6  
*See also* Reset NVM to Factory Settings

Okidata Microline 92 Printer Connections 2-12, 5-3, 13-18  
*See also* Printer Connections  
OnLine/Local 2-4  
On-screen Calculator 1-7, **Chapter 6**

Pages (of Display Memory) 10-2, 12-7  
Page Number 10-2, 12-6  
Pan Definition Mode 3-5, 4-3, 7-5, **Chapter 8, 9**, 12-6  
Pan Box **Chapter 8, 9**  
Parity 3-4, 3-6, 3-8, 12-6  
Parity Checking of Input 3-4, 3-6, 3-8  
Port 3 Input From 3-10, 5-4, 7-2  
Port Number 2-8, 3-6, 12-6  
Port Pin Assignments 3-3  
Power Cord 1-4, 1-6, 11-1  
*Prev Scrn* 5-2, 8-4  
Print Buffer 2-13, 5-4, 5-5, 9-2, 12-6  
*Print Scrn* 1-8, 2-4, 3-9, 8-10, 12-6, 13-11  
Print Terminator 3-9  
Printed Data Type 3-9, 13-1, 13-11  
Printer  
- Connections *See Chapter 3 and Appendix C*  
- Selecting a Graphics Printer 2-12, 5-2  
- Settings 2-12, 3-8, 3-9, 13-11 through 13-19  
Printing Extent 3-9  
Printer Mode 3-9  
Printer To Host 3-9

**CTRL Q** (Resume Transmission) 2-4, 3-5, 3-7, 3-9, 12-7  
*See also* XON/XOFF Protocol  
Quadrant Mode *See* Graphics Quadrants, **Chapter 9**

RAM Memory 4-3, 12-6  
Recall Settings From NVM (Hard) 2-3, 2-5, 3-6, 12-6  
Receive Speed 3-4, 3-7 *See* Baud Rate  
Remote Mode Processing *See* OnLine/Local  
*Remove* 5-2, 8-2, 8-3, 8-6  
Replace/Insert Mode 2-4



Reset All Windows To Default 2-15, 10-8  
Reset NVM to Factory Defaults 2-3, 2-5  
Reset *See* Recall Settings From NVM, Reset NVM to Factory Defaults  
Reset Terminal (Soft) 2-5, 12-6  
Reset Tabs To Every 8 Columns 2-6  
Return 1-6, 4-1, 4-3  
    *See also* Enter, New Line  
Reverse Video 2-7, 2-16, 12-5  
right arrow 2-1, 2-2, 2-6, 4-2, 8-8, 10-2  
RS-232 Connector 3-1, 3-2, 3-3, 12-6  
RS-423 Interface 3-12, 12-6  
RTS Signal 3-2, 3-7

CTRL S (Stop Transmission) 2-4, 3-6, 3-7, 3-8  
    *See also* XON/XOFF Protocol  
Save Settings into NVM 2-5, 3-6, 12-7  
    *See also* Reset NVM to Factory Defaults  
Scaling Operations **Chapter 9**, 12-7  
Screen Display 2-7, 2-15  
Screen Lines 2-14, 2-15, **Chapter 10**, 12-7  
Screen Saver Feature 1-4, 1-5  
Screen Video 2-7, 10-4  
Scrolling 2-7, 12-7  
    *See also* Display Memory, Pages (of Display Memory)  
Scrolling Region 3-9  
Select Current Window 2-14  
Self Test 11-2, 11-3, 11-4, 12-7, 13-11  
    *See also* Checking Out The Terminal  
Setup 1-4, 1-8, **Chapter 2**  
Setup Mode *See* 1-4, 1-11, 3-6, **Chapter 2** 12-7  
    - Disabling 2-2  
    - Keys 1-9, 2-1  
    - Menus **Chapters 2, 3, 4, 5, 6, and 10**  
    - Settings 2-3 through 2-15, 3-6, 3-7, 3-8  
Shift 1-6, 12-7  
Shift Break 3-2  
Source Origin 2-15, 9-6, 12-7  
Space 1-6  
Status or (Shift Setup) 2-15, 9-5  
Status Line *See also* Message Line  
    - ANSI text 2-15  
    - Graphics 2-15, 9-5, 13-22  
Stop Bits 3-5, 3-7, 3-11, 12-7

Tab Settings (Tab) 1-6, 1-11, 2-6, 4-7, 7-4, 12-7  
    - In Setup Mode 2-3, 2-6

Terminal  
    - Characteristics 1-1 through 1-3, 12-7  
    - Maintenance **Chapter 11**  
    - Models 1-2, 5-1, 13-22 *See* HDS3200 Models  
    - Self Tests 11-3, 11-4  
        *See also* Checking Out The Terminal  
    - Software Version 2-4

## HDS3200 Owner's Manual

- Terminal ID 2-5, 2-6  
Terminal Operating Mode 2-5, 2-6, 2-8, 3-5, 3-6, 3-7, 5-1  
*See also* VT100, VT220, VT52  
Text Graph 1-8, 5-2, 9-1, 12-7  
Times 1 Function 12-7 *See* Draw Function  
Transmit Speed 3-4, 3-6 *See* Baud Rate  
Transparent Mode 2-5, 4-2  
25-line Mode 1-2, 2-7, 2-14, 7-4, 10-5, 10-8
- Unpacking the Terminal 1-3  
up arrow 1-10, 2-2, 8-2, 8-3, 8-5  
User Defined Keys *See* **Chapter 4**, 1-9, 2-6, 2-9, 3-8, 10-6, 10-7, 12-8  
- Factory Definitions 4-4, 4-5, 4-6  
- Locking Definitions 4-4  
- Mouse Buttons 4-3, 4-5, 4-7, 7-5  
- Programming in Setup Mode 4-2, 7-4  
- Setup Menu 2-9  
- Three Sets 4-1, 4-4, 10-6, 10-7  
User Features Command 2-7  
User Preference Setup Menu 2-6
- Value 2-1, 12-8  
Video Output Connection *See* **Appendix F** 13-24  
VT100 Terminal Emulation 2-5, 2-6, 4-6, 5-1, 12-8, 13-23  
VT220 Terminal Emulation 1-2, 2-5, 2-6, 5-1, 10-2, 12-8  
VT52 Terminal Emulation *See* **Appendix E**, 2-5, 2-6, 12-8, 13-23  
- Function Key Assignments 13-23  
Virtual Terminals 10-6
- Warning Bell 1-11  
Window Definition 2-14, **Chapter 10**, 12-8  
Window Video 2-15, 10-4  
Write Onto Page Number 3-9
- XON/XOFF Protocol 1-8, 2-4, 3-1, 3-4, 3-6, 3-8, 5-3, 6-1, 12-8, 13-11  
*See also* Communications Protocol  
CTRL Q (Resume Transmission)  
CTRL S (Stop Transmission)
- Zoom Box **Chapter 8, 9**  
Zoom Definition Mode 2-15, 3-5, 4-3, 7-5, **Chapter 8**, 12-8  
Zoom Factor 2-15, **Chapter 8,9**

# HDS3200 Owner's Manual