

# Peripheral Installation Guide

HP 9000 Series 200/300 Computers

HP Part Number 97005-90000



**Hewlett-Packard Company**

3404 East Harmony Road, Fort Collins, Colorado 80525

## NOTICE

The information contained in this document is subject to change without notice.

HEWLETT-PACKARD MAKES NO WARRANTY OF ANY KIND WITH REGARD TO THIS MANUAL, INCLUDING, BUT NOT LIMITED TO, THE IMPLIED WARRANTIES OF MERCHANTABILITY AND FITNESS FOR A PARTICULAR PURPOSE. Hewlett-Packard shall not be liable for errors contained herein or direct, indirect, special, incidental or consequential damages in connection with the furnishing, performance, or use of this material.

## WARRANTY

A copy of the specific warranty terms applicable to your Hewlett-Packard product and replacement parts can be obtained from your local Sales and Service Office.

Copyright 1985, 1987 Hewlett-Packard Company

This document contains proprietary information which is protected by copyright. All rights are reserved. No part of this document may be photocopied, reproduced or translated to another language without the prior written consent of Hewlett-Packard Company. The information contained in this document is subject to change without notice.

### Restricted Rights Legend

Use, duplication or disclosure by the Government is subject to restrictions as set forth in paragraph (b)(3)(B) of the Rights in Technical Data and Software clause in DAR 7-104.9(a).

Use of this manual and flexible disc(s) or tape cartridge(s) supplied for this pack is restricted to this product only. Additional copies of the programs can be made for security and back-up purposes only. Resale of the programs in their present form or with alterations, is expressly prohibited.

Copyright 1980, 1984, AT&T, Inc.

Copyright 1979, 1980, 1983, The Regents of the University of California.

This software and documentation is based in part on the Fourth Berkeley Software Distribution under license from the Regents of the University of California.

# Printing History

---

New editions of this manual will incorporate all material updated since the previous edition. Update packages may be issued between editions and contain replacement and additional pages to be merged into the manual by the user. Each updated page will be indicated by a revision date at the bottom of the page. A vertical bar in the margin indicates the changes on each page. Note that pages which are rearranged due to changes on a previous page are not considered revised.

The manual printing date and part number indicate its current edition. The printing date changes when a new edition is printed. (Minor corrections and updates which are incorporated at reprint do not cause the date to change.) The manual part number changes when extensive technical changes are incorporated.

July 1985...Edition 1

November 1985...Edition 2

February 1987...Edition 3

July 1987...Update to include HP 98248A Floating-Point Accelerator, HP 98548/49/50A High Resolution Video Boards, and new HP-HIL peripherals.

September 1987...Edition 4. Merged Update and revised for HP-UX 6.0.



# Table of Contents

---

## Step 1: Getting Started

BASIC System Worksheet .....	1-3
Pascal Workstation Worksheet .....	1-5
HP-UX System Worksheet .....	1-7

## Step 2: Adding Backplane Expanders

Installing the HP 98568A Backplane Expander .....	2-2
Installing the HP 98577A VMEbus Expander .....	2-9
Adding VMEbus Cards .....	2-18

## Step 3: Adding RAM

Before Starting the Installation .....	3-2
The Expander .....	3-2
Installing RAM Cards in Series 200 and Model 310/320 Computers .....	3-3
Help with the Memory Configuration Wheels .....	3-4
Some Common Mistakes .....	3-6
Installing RAM Boards in Series 300 Model 330 Computers .....	3-7
Optimizing Model 330 Performance .....	3-9
Installing RAM Boards in Series 300 Model 350 Computers .....	3-11
Identifying Existing RAM Boards .....	3-12
Assigning the Addresses .....	3-14
Installing the RAM Board .....	3-17
In Case of Trouble .....	3-21

## Step 4: Adding Accessory Cards

Installing an HP 98620B DMA Controller Card .....	4-2
Installing the HP 98635A Floating Point Math Card .....	4-4
Installing the HP 98603A BASIC 4.0 ROM Card .....	4-6
Installing an HP 98248A Series 300 Floating-Point Accelerator .....	4-8
Installing the HP 98556A 2D Graphics Accelerator .....	4-12

## Step 5: Adding Interface Cards

Installing the HP 98253A EPROM Programmer Interface .....	5-2
BASIC System Worksheet Entry .....	5-6
Pascal Workstation Worksheet Entry .....	5-6
Installing the HP 98287A Graphics Display Station Interface .....	5-7

BASIC System Worksheet Entry .....	5-13
Pascal Workstation Worksheet Entry .....	5-13
HP-UX System Worksheet Entry .....	5-13
Installing the HP 98546A Display Compatibility Interface .....	5-14
BASIC System Worksheet Entry .....	5-18
Pascal Workstation Worksheet Entry .....	5-18
HP-UX System Worksheet Entry .....	5-18
Installing the HP 98622A GPIO Interface .....	5-19
BASIC System Worksheet Entry .....	5-25
Pascal Workstation Worksheet Entry .....	5-25
HP-UX System Worksheet Entry .....	5-25
Installing the HP 98623A BCD Interface .....	5-26
BASIC System Worksheet Entry .....	5-29
Installing the HP 98624A HP-IB Interface .....	5-30
BASIC System Worksheet Entry .....	5-35
Pascal Workstation Worksheet Entry .....	5-35
HP-UX System Worksheet Entry .....	5-35
Installing the HP 98625A Disc Interface .....	5-36
BASIC System Worksheet Entry .....	5-41
Pascal Workstation Worksheet Entry .....	5-41
HP-UX System Worksheet Entry .....	5-41
Installing the HP 98625B Disc Interface .....	5-42
BASIC System Worksheet Entry .....	5-48
Pascal Workstation Worksheet Entry .....	5-48
HP-UX System Worksheet Entry .....	5-48
Installing the HP 98626A RS-232C Interface .....	5-49
BASIC System Worksheet Entry .....	5-58
Pascal Workstation Worksheet Entry .....	5-58
HP-UX System Worksheet Entry .....	5-58
Installing the HP 98627A Color Output Interface .....	5-59
BASIC System Worksheet Entry .....	5-64
Pascal Workstation Worksheet Entry .....	5-64
HP-UX System Worksheet Entry .....	5-64
Installing the HP 98628A Datacomm Interface .....	5-65
BASIC System Worksheet Entry .....	5-73
Pascal Workstation Worksheet Entry .....	5-74
HP-UX System Worksheet Entry .....	5-74
Installing the HP 98629A and HP 50961A SRM Interfaces .....	5-75
BASIC System Worksheet Entry .....	5-77
Pascal Workstation Worksheet Entry .....	5-77
HP-UX System Worksheet Entry .....	5-77

Installing the HP 98633A Multiprogrammer Interface .....	5-78
BASIC System Worksheet Entry .....	5-82
Installing the HP 98640A Analog Input Card .....	5-83
BASIC System Worksheet Entry .....	5-87
Installing the HP 98642A 4-Channel Multiplexer Interface .....	5-88
HP-UX System Worksheet Entry .....	5-93
Installing the HP 98643A Local Area Network (LAN) Interface .....	5-94
HP-UX System Worksheet Entry .....	5-96
Installing the HP 98644A RS-232C Serial Interface .....	5-97
BASIC System Worksheet Entry .....	5-103
Pascal Workstation Worksheet Entry .....	5-103
HP-UX System Worksheet Entry .....	5-103
Installing the HP 98695A IBM 3270 Coax Interface .....	5-104
BASIC System Worksheet Entry .....	5-108
Pascal Workstation Worksheet Entry .....	5-108
Installing the HP 98562-66530 Human (System) Interface Board .....	5-109
BASIC System Worksheet Entry .....	5-118
Pascal Workstation Worksheet Entry .....	5-119
HP-UX System Worksheet Entry .....	5-119
Installing the HP 98548/49/50A High Resolution Video Boards .....	5-120
HP-UX System Worksheet Entry .....	5-125
Installing the HP 98724A and 98725A Local Graphics Bus Interface .....	5-126
HP-UX System Worksheet Entry .....	5-129
Installing the HP 98265A Small Computer Systems Interface (SCSI) .....	5-130
HP-UX System Worksheet Entry .....	5-139

## **Step 6: Adding Mass Storage Devices**

Installing Model 226/236 Internal Disc Drives .....	6-2
BASIC System Worksheet Entries .....	6-2
Pascal Workstation Worksheet Entries .....	6-3
HP-UX System Worksheet Entries .....	6-3
Installing the HP 7907A Disc Drive .....	6-4
BASIC System Worksheet Entries .....	6-7
Pascal Workstation Worksheet Entries .....	6-8
HP-UX System Worksheet Entries .....	6-9
Installing HP 7911, 7912, and 7914 Disc/Tape Drives .....	6-10
BASIC System Worksheet Entries .....	6-16
Pascal Workstation Worksheet Entries .....	6-17
HP-UX System Worksheet Entries .....	6-18
Installing the HP 7933 and 7935 Disc Drives .....	6-20
Pascal Workstation Worksheet Entries .....	6-24
HP-UX System Worksheet Entries .....	6-24

Installing the HP 7936H and 7937H Disc Drives . . . . .	6-25
BASIC System Worksheet Entries . . . . .	6-29
Pascal Workstation Worksheet Entries . . . . .	6-29
HP-UX System Worksheet Entries . . . . .	6-29
Installing the HP 7941, 7942, 7945 and 7946 Disc and Disc/Tape Drives . . . . .	6-30
BASIC System Worksheet Entries . . . . .	6-33
Pascal Workstation Worksheet Entries . . . . .	6-34
HP-UX System Worksheet Entries . . . . .	6-34
Installing the HP 7957A and 7958A Disc Drives . . . . .	6-35
BASIC System Worksheet Entries . . . . .	6-37
Pascal Workstation Worksheet Entries . . . . .	6-38
HP-UX System Worksheet Entries . . . . .	6-38
Installing the HP 7971A Tape Drive . . . . .	6-39
HP-UX System Worksheet Entries . . . . .	6-42
Installing the HP 7974A Tape Drive . . . . .	6-43
HP-UX System Worksheet Entries . . . . .	6-47
Installing the HP 7978A Tape Drive . . . . .	6-48
HP-UX System Worksheet Entries . . . . .	6-52
Installing the HP 9121 and 9122 Flexible Disc Drives . . . . .	6-53
BASIC System Worksheet Entries . . . . .	6-56
Pascal Workstation Worksheet Entries . . . . .	6-56
HP-UX System Worksheet Entries . . . . .	6-57
Installing the HP 9125S and 9127A Flexible Disc Drives . . . . .	6-58
BASIC System Worksheet Entries . . . . .	6-60
Pascal Workstation Worksheet Entry . . . . .	6-61
HP-UX System Worksheet Entries . . . . .	6-61
Installing the HP 9133D/H/L and 9134D/H/L Disc Drives . . . . .	6-62
BASIC System Worksheet Entries . . . . .	6-66
Pascal Workstation Worksheet Entries . . . . .	6-69
HP-UX System Worksheet Entries . . . . .	6-70
Installing the HP 9144A Tape Drive . . . . .	6-73
BASIC System Worksheet Entries . . . . .	6-76
Pascal Workstation Worksheet Entries . . . . .	6-77
HP-UX System Worksheet Entries . . . . .	6-77
Installing the HP 9153A and 9154A Disc Drives . . . . .	6-78
BASIC System Worksheet Entries . . . . .	6-82
Pascal Workstation Worksheet Entries . . . . .	6-85
HP-UX System Worksheet Entries . . . . .	6-86
Installing the HP 9895A Disc Drive . . . . .	6-89
BASIC System Worksheet Entries . . . . .	6-92
Pascal Workstation Worksheet Entries . . . . .	6-92



HP-UX System Worksheet Entries .....	6-93
Installing HP 98255A EPROM Memory Cards .....	6-94
BASIC System Worksheet Entries .....	6-98
Pascal Workstation Worksheet Entry .....	6-98
Installing the HP 98259A Bubble Memory Card .....	6-99
BASIC System Worksheet Entries .....	6-103
Pascal Workstation Worksheet Entry .....	6-103
Determining Your BASIC Msvs .....	6-105
Rules for Determining Your Msvs .....	6-105
Determining Pascal Unit Numbers .....	6-108
Determining Flexible Disc Drive Unit Numbers .....	6-110
Determining Hard Disc Drive Unit Numbers .....	6-111
Determining Tape Drive Unit Numbers .....	6-116
Determining HP-UX Minor Numbers .....	6-117

### Step 7: Adding Printers

Installing the HP 2225A ThinkJet Printer .....	7-2
BASIC System Worksheet Entries .....	7-5
Pascal Workstation Worksheet Entry .....	7-6
HP-UX System Worksheet Entries .....	7-6
Installing the HP 2227A/B QuietJet Plus and 2228A QuietJet Printers .....	7-7
BASIC System Worksheet Entries .....	7-11
Pascal Workstation Worksheet Entries .....	7-11
HP-UX System Worksheet Entries .....	7-12
Installing the HP 2563A, 2565A and 2566A Printers .....	7-14
BASIC System Worksheet Entries .....	7-17
Pascal Workstation Worksheet Entry .....	7-17
HP-UX System Worksheet Entries .....	7-18
Installing the HP 2601A Printer .....	7-19
BASIC System Worksheet Entry .....	7-22
Pascal Workstation Worksheet Entry .....	7-22
Installing the HP 2602A Printer .....	7-23
BASIC System Worksheet Entries .....	7-26
Pascal Workstation Worksheet Entry .....	7-26
Installing the HP 2608S Printer .....	7-27
HP-UX System Worksheet Entries .....	7-30
Installing the HP 2671A/G Printers .....	7-31
BASIC System Worksheet Entries .....	7-34
Pascal Workstation Worksheet Entry .....	7-35
HP-UX System Worksheet Entries .....	7-35
Installing the HP 2673A Printer .....	7-36
BASIC System Worksheet Entries .....	7-39

Pascal Workstation Worksheet Entry .....	7-39
HP-UX System Worksheet Entries .....	7-40
Installing the HP 2686A/D LaserJet and HP 33440A LaserJet-II Printer ....	7-41
BASIC System Worksheet Entry .....	7-44
Pascal Workstation Worksheet Entry .....	7-44
HP-UX System Worksheet Entries .....	7-45
Installing the HP 2932A and 2934A Printers .....	7-47
BASIC System Worksheet Entries .....	7-51
Pascal Workstation Worksheet Entry .....	7-52
HP-UX System Worksheet Entries .....	7-52
Installing the HP 82905B and 82906A Printers .....	7-53
BASIC System Worksheet Entries .....	7-56
Pascal Workstation Worksheet Entry .....	7-56
HP-UX System Worksheet Entries .....	7-57
Installing the HP 9876A Printer .....	7-58
BASIC System Worksheet Entries .....	7-61
Pascal Workstation Worksheet Entry .....	7-61
HP-UX System Worksheet Entries .....	7-62

### **Step 8: Adding Plotters & Other Graphics Devices**

Installing a Plotter (HP-IB Interface) .....	8-2
BASIC System Worksheet Entries .....	8-7
Pascal Workstation Worksheet Entries .....	8-7
HP-UX System Worksheet Entries .....	8-8
Installing an HP 7510 Color Film Recorder .....	8-9
BASIC System Worksheet Entries .....	8-11
Installing the HP 9111A Graphics Tablet .....	8-12
BASIC System Worksheet Entries .....	8-15
Pascal Workstation Worksheet Entries .....	8-15
HP-UX System Worksheet Entries .....	8-16
Installing the HP 98700 Graphics Display Station .....	8-17
BASIC System Worksheet Entries .....	8-20
Pascal Workstation Worksheet Entries .....	8-21
HP-UX System Worksheet Entries .....	8-21
Installing the HP 13279B Color Monitor .....	8-22
BASIC System Worksheet Entry .....	8-24
Pascal Workstation Worksheet Entry .....	8-24
HP-UX System Worksheet Entry .....	8-24
Installing the HP 98720A Graphics Display Station .....	8-25
HP-UX System Worksheet Entries .....	8-27

## Step 9: Adding Terminals and Displays

Installing HP Terminals .....	9-2
HP-UX System Worksheet Entries .....	9-13

## Step 10: Adding Miscellaneous Peripherals

Installing the HP 35723A HP Touch Bezel .....	10-2
BASIC System Worksheet Entry .....	10-7
Pascal Workstation Worksheet Entry .....	10-7
HP-UX System Worksheet Entries .....	10-8
Installing the HP 37212A 300/1200 Baud Modem .....	10-9
Pascal Workstation Worksheet Entry .....	10-12
HP-UX System Worksheet Entries .....	10-12
Installing the HP 39800/01A Programmable Bar Code Reader .....	10-14
BASIC System Worksheet Entries .....	10-17
Installing the HP 46020/21 Keyboards .....	10-18
BASIC System Worksheet Entry .....	10-20
Pascal Workstation Worksheet Entry .....	10-20
HP-UX System Worksheet Entries .....	10-21
Installing the HP 46060A/B Mouse .....	10-22
BASIC System Worksheet Entry .....	10-24
Pascal Workstation Worksheet Entry .....	10-25
HP-UX System Worksheet Entries .....	10-25
Installing the HP 46080A Extension Module .....	10-26
BASIC System Worksheet Entry .....	10-28
Pascal Workstation Worksheet Entry .....	10-28
HP-UX System Worksheet Entries .....	10-29
Installing the HP 46081A Speaker Module .....	10-30
BASIC System Worksheet Entry .....	10-32
Pascal Workstation Worksheet Entry .....	10-33
HP-UX System Worksheet Entries .....	10-33
Installing the HP 46082A/B Remote Extension Modules .....	10-34
BASIC System Worksheet Entry .....	10-37
Pascal Workstation Worksheet Entry .....	10-38
HP-UX System Worksheet Entries .....	10-38
Installing the HP 46083A Rotary Control Knob .....	10-39
BASIC System Worksheet Entry .....	10-41
Pascal Workstation Worksheet Entry .....	10-41
HP-UX System Worksheet Entries .....	10-42
Installing the HP 46084A ID Module .....	10-43
BASIC System Worksheet Entry .....	10-45
Pascal Workstation Worksheet Entry .....	10-46
HP-UX System Worksheet Entries .....	10-46

Installing the HP 46085A Control Dials Module .....	10-47
BASIC System Worksheet Entry .....	10-49
HP-UX System Worksheet Entries .....	10-50
Installing the HP 46086A Button Box .....	10-51
BASIC System Worksheet Entry .....	10-53
HP-UX System Worksheet Entries .....	10-54
Installing the HP 46087/88A Digitizers and HP 46089A Cursor .....	10-55
BASIC System Worksheet Entry .....	10-57
Pascal Workstation Worksheet Entry .....	10-58
HP-UX System Worksheet Entries .....	10-58
Installing the HP 46094A Quadrature Port .....	10-59
BASIC System Worksheet Entry .....	10-61
Pascal Workstation Worksheet Entry .....	10-61
HP-UX System Worksheet Entries .....	10-62
Installing the HP 6944A Multiprogrammer .....	10-63
BASIC System Worksheet Entry .....	10-65
Installing the HP 92205A/C Hayes Smartmodem 1200 .....	10-66
BASIC System Worksheet Entries .....	10-68
Pascal Workstation Worksheet Entry .....	10-69
HP-UX System Worksheet Entries .....	10-69
Installing the HP 92916A Bar Code Reader .....	10-71
BASIC System Worksheet Entry .....	10-74
Pascal Workstation Worksheet Entry .....	10-75
HP-UX System Worksheet Entries .....	10-75
Installing the HP 9884A Paper Tape Punch .....	10-76
Pascal Workstation Worksheet Entry .....	10-77
Installing the HP 46030A Vectra Keyboard .....	10-78
BASIC System Worksheet Entries .....	10-80
Installing the HP 45911A Graphics Tablet .....	10-81
BASIC System Worksheet Entry .....	10-83
Pascal Workstation Worksheet Entry .....	10-84
HP-UX System Worksheet Entries .....	10-84
Installing the HP 98203C Keyboard .....	10-85
BASIC System Worksheet Entry .....	10-87
Pascal Workstation Worksheet Entry .....	10-87

# Getting Started

---

# 1

## Description

This manual describes how to add many common peripherals and accessories to your HP Series 200 or Series 300 computer system. Installation instructions are provided for:

- Interface and accessory cards
- Disc and tape drives
- Printers
- Plotters and other graphics devices
- HP-HIL devices
- Additional monitors
- Terminals
- Modems
- Miscellaneous peripherals

---

## Support

Each installation procedure in this manual contains a section called “Support” that describes which computers and operating/language systems the product is supported on. Do not attempt to install a peripheral or accessory unless it is supported on your particular combination of computer and operating/language system.

The support information contained in this manual was accurate at the time of printing. However, support status for peripherals and accessories may change rapidly, and peripherals listed as unsupported at the time of this printing may be supported at a later date.

For up-to-date support status on peripherals of interest, contact your HP Sales and Service office.

---

## Before You Begin

Refer to the instructions that came with your computer to:

- Connect the keyboard to your computer.
- Connect the monitor to your computer.

---

## Instructions

This book contains 10 steps, and each step is marked with a tab. Follow the steps in sequence until you run out of things to install, or you run out of steps, whichever comes first.

If you find no instructions in this guide for your particular peripheral, use the installation instructions provided with the peripheral to install it. However, look for “generic” installation instructions (e.g., “Installing Other Disc Drives”) if your peripheral is not explicitly listed.

---

## The Next Step

You have just completed Step 1. Now move on to Step 2.

---

# BASIC System Worksheet

## Interface Cards

Interface Name	Select Code	Driver Name

## Mass Storage Devices

Device Name	Msvs	Driver Name	Interleave Factor

---

## BASIC System Worksheet (Cont.)

### Printers

Device Name	Device Selector

### Plotters/Graphics Devices

Device Name	Device Selector	Display/Plotter Specifier

### Miscellaneous Peripherals

Device Name	Device Selector	Digitizer Specifier	Power Req.



---

# Pascal Workstation Worksheet

## Interface Cards

Interface Name	Select Code	Module Name

## Mass Storage Devices

Device Name	Unit Numbers	Module Name	Interleave Factor

---

## Pascal Workstation Worksheet (Cont.)

### Printer

Device Name	Device Selector
	#6

### Plotters/Graphics Devices

Device Name	Device Selector

### Miscellaneous Peripherals

Device Name	Device Selector	Module Name	Power Req.



---

## HP-UX System Worksheet (Cont.)

### Printers

Device Name	Path Name	File Type	Major Number	Minor Number

### Plotters/Graphics Devices

Device Name	Path Name	File Type	Major Number	Minor Number

---

# HP-UX System Worksheet (Cont.)

## Terminals & Displays

Device Name	Path Name	File Type	Major Number	Minor Number

## Miscellaneous

Device Name	Path Name	File Type	Major Number	Minor Number	Power Req.



# Adding Backplane Expanders

---

# 2

If you are adding either of the products listed below to your Series 300 computer, turn to the indicated page number and follow the instructions. Otherwise, go to Step 3.

<b>Backplane Expander Name</b>	<b>Page Number</b>
HP 98568A Backplane Expander	See page 2-2
HP 98577A VMEbus Expander	See page 2-9

---

# Installing the HP 98568A Backplane Expander

## Description

The HP 98568A Backplane Expander adds 8 additional I/O and Accessory slots to your Series 300 computer.

## Support

You can use the HP 98568A Backplane Expander with Series 300 Model 310, 320, 330, and 350 computers.

Operating/Language system support is as follows:

- **BASIC:** supported on revision 4.0 or later with Model 310 and 320 computers; supported on revision 5.0 or later with Model 330 and 350 computers.
- **Pascal Workstation:** supported on revision 5.0 or later with Model 310 and 320 computers; supported on revision 5.2 or later with Model 330 and 350 computers.
- **HP-UX Operating System:** supported on revision 3.1 or later with Model 310 and 320 computers; supported on revision 3.2 or later with Model 330 and 350 computers.



## HP 98568A Backplane Expander Installation Procedure

1. Turn the computer power off and unplug the power cord from the rear panel.
2. Loosen the two captive screws securing the power supply access door on the computer and remove the access door. You may need a Pozidriv screwdriver to loosen the captive screws.

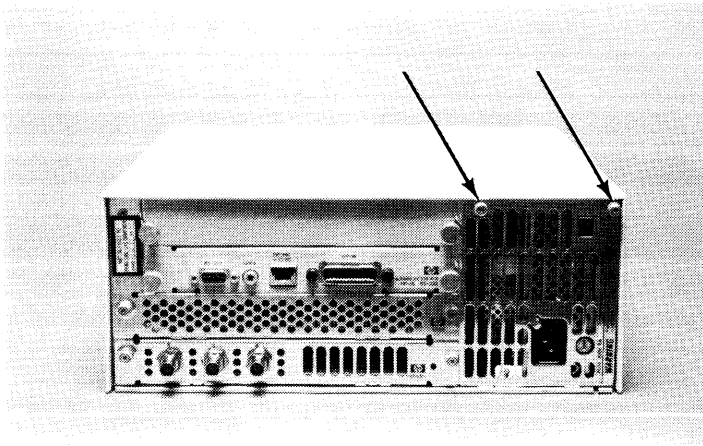

### Access Door Screws

3. Slide the computer top cover toward the rear of the computer. Then spring the sides out and up and lift it off.
4. Install the two flat cables received with the expander into the two connectors on the top edge of the computer's four-slot backplane. Be careful not to bend any of the pins in the connector. Press in until the locking tabs lock across the back of the cable connector.

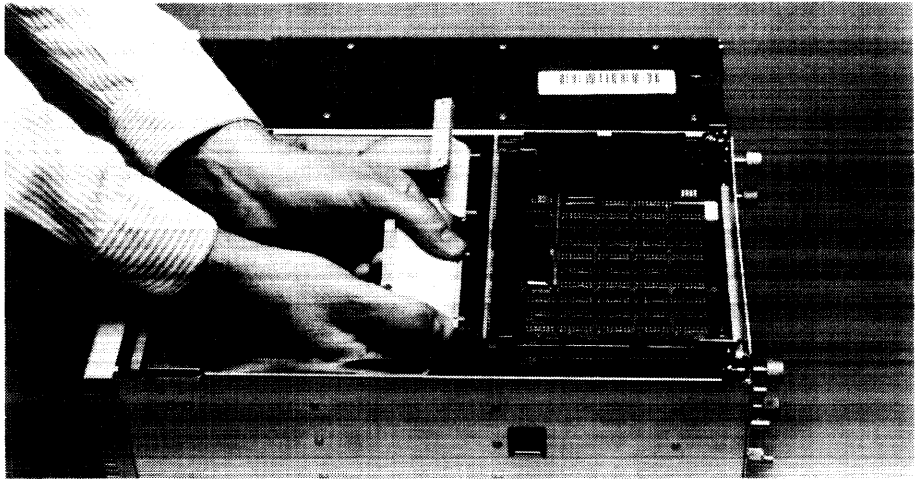

### **Installing the Two Cables**

5. Bend the cables so that the free ends point upward.
6. Loosen the two captive screws securing the expander power supply access door and remove the access door.
7. Slide the computer top cover toward the rear of the computer. Then spring the sides out and up and lift it off.
8. Place the expander upside-down on a flat, solid surface.
9. Locate the two sliding clips on the top of the slotted cover and press them toward each other as far as they will go.

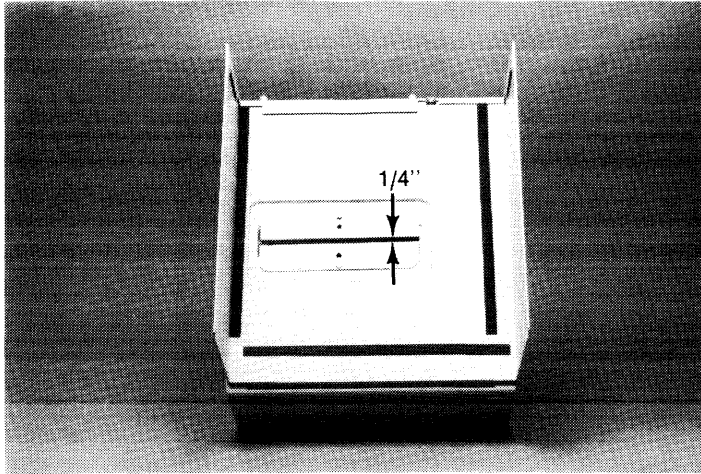

### Sliding Clips

10. Place the slotted cover upside-down on the bottom of the expander, with the front of the cover toward the front of the expander. The slot in the cover should line up with the slot in the expander.
11. Align the top so that it is centered side-to-side.

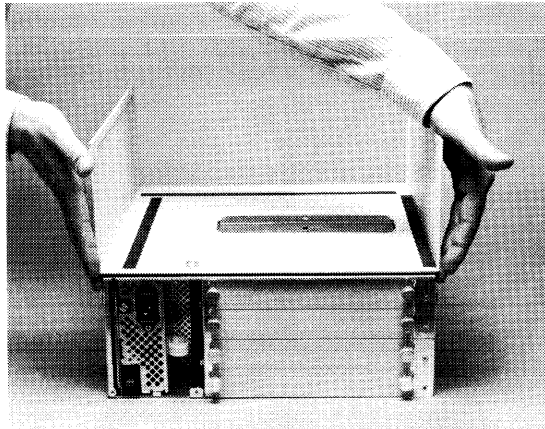

### Aligning the Top from Side-to-Side

- Align the top so that the rear edge of the cover is even with the rear edge of the expander bottom. The indent at the front of the top should fit over the plastic feet on the expander.

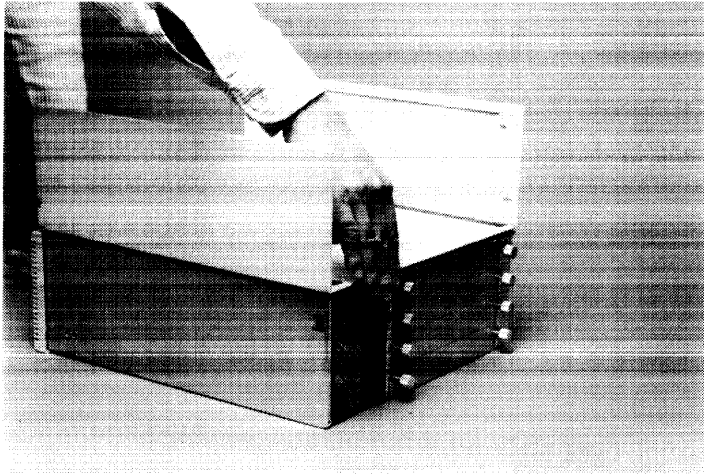

**Aligning the Top from Front-to-Back**

- Press the sliding clips onto the edges of the opening. Press the clips until they “snap” into place.

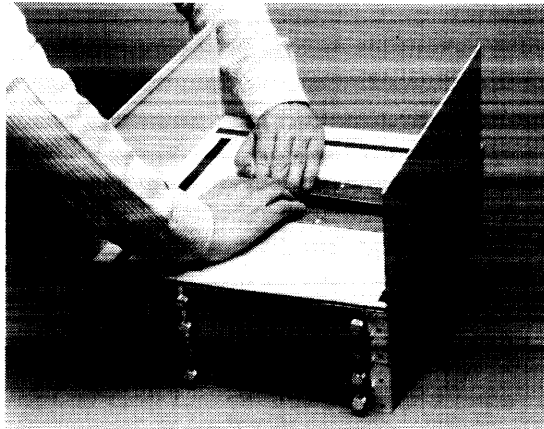

**Pressing the Clips into Place**

---

### NOTE

If the sliding clips are difficult to install, make sure that the top is properly aligned. If so, work on one end of the clips at a time.

---

14. Turn the expander and attached cover over and place it on top of the computer with the cables passing up through the slot in the bottom of the expander.
15. Slide the top cover into place on the computer. Press in on the front edge of the cover with the heels of your hands while pressing in on the rear corners with your elbows.

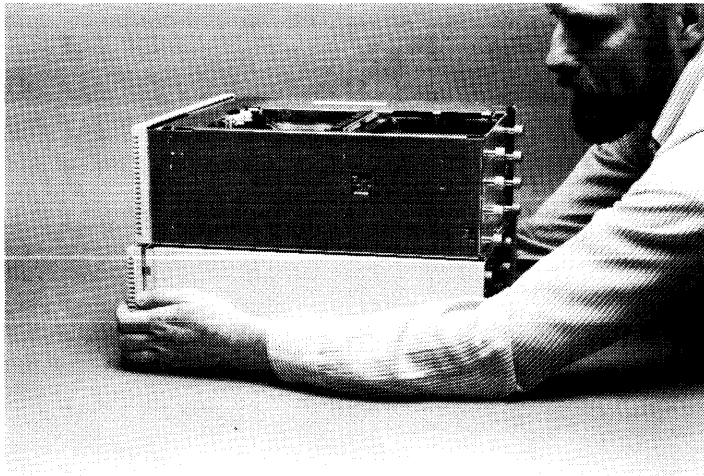

**Installing the Cover on the Computer**

16. Make sure that the bottom, rear corners of the top are seated in their retaining clips. If you can flex the rear corners of the cover away from the computer, they are not seated properly.
17. Install the two cables onto the bottom of the expander backplane. Be careful not to bend any of the pins in the connector. Press in until the locking tabs lock across the back of the cable connector.
18. Install the top cover removed from the computer onto the expander using the method in step 15. Make sure that the bottom, rear corners of the top are seated in their retaining clips.
19. Re-install the power supply access doors on the computer and expander and tighten the captive screws. Make sure that the “feet” on the bottom of the door are installed in their retaining grooves.
20. Refer to chapters 3, 4 and 5 of this manual to install various cards in the expander. When finished installing cards, don't forget to connect the power cords to the computer and expander.

---

## The Next Step

You have completed Step 2. Now move on to Step 3.

---

# Installing the HP 98577A VMEbus Expander

## Description

The HP 98577A Series 300 VMEbus Expander is a VME backplane which conforms to the VITA C.1 specifications for bus protocol and physical format. It consists of a chassis plus some code segments in HP-UX 6.0 and a Driver Development Manual so you can write a custom driver for your application. It holds any four of about 3000 aftermarket VME boards.

## Support

You can use the HP 98577A VMEbus Expander with Series 300 Model 330 and 350 computers.

Operating/Language system support is as follows:

- **BASIC:** not supported.
- **Pascal Workstation:** not supported.
- **HP-UX Operating System:** supported on revision 6.0 or later with Series 300 Model 330/350 computers.

## HP 98577A VMEbus Installation Procedure

1. Turn the computer off and remove the power cord.
2. Loosen the two captive screws securing the power supply access door on the computer and remove the access door. You may need a #1 Pozidriv screwdriver to loosen the captive screws.

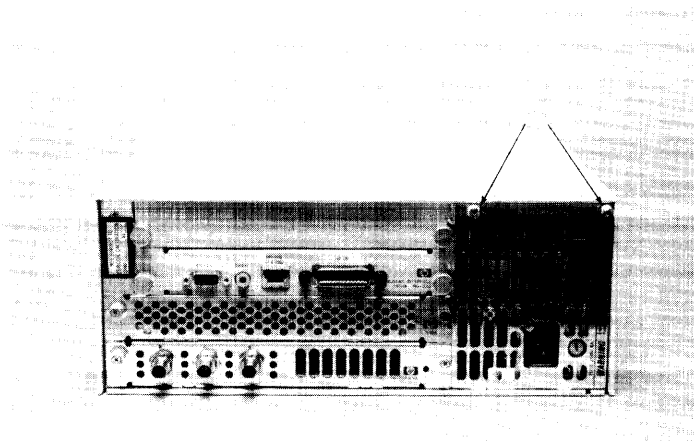

### Power Supply Door Screws

3. Check the Serial Number

---

#### CAN YOU SKIP THIS STEP?

If you have a Model 350 computer, skip to the next step. If you have a Model 330 computer, you may need a new processor board. To determine this, follow the instructions in this step.

---

- a. Find the Serial Number, located on the sheet metal base just inside the power supply access door of the computer. If the first four digits read 2740 or higher, the board will operate correctly with the VMEbus Expander. If they are 2739 or lower, you will need a new processor board. Contact your Sales and Service Office for a free replacement. Refer them to Service Note 98562A-1.



4. Check that the Voltage Select Switch is in the correct position for the power supplied in your area. If you do not know what it should be, make sure that it is set the same as your computer.

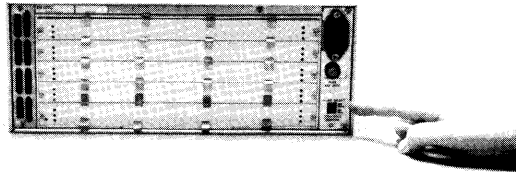

**Voltage Select Switch**

5. Slide the computer top cover toward the rear of the computer. Then spring the sides out and up, and lift it off.
6. Remove the Pozidriv screw securing the Expander cover. It is located on the top edge of the rear panel.

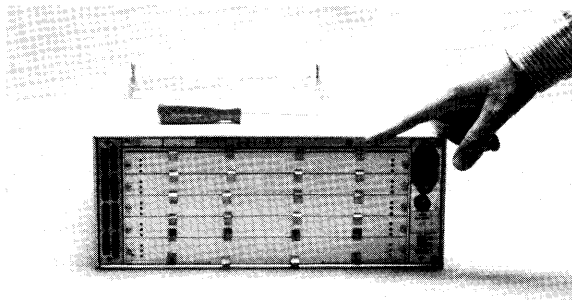

**Locating the Cover Screw**

7. Remove the Expander cover and install it on the computer. Start the front edge first, at a 45° angle.

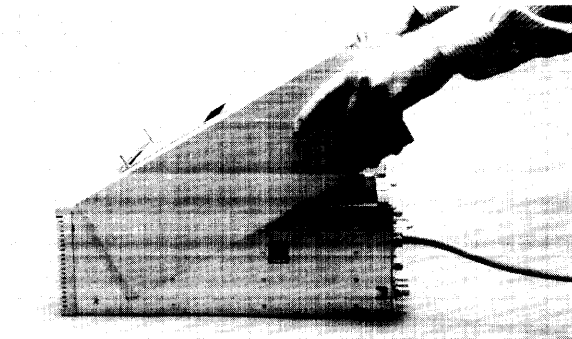

**Installing the Cover**

8. Press the slotted cover down, then slide it forward. Make sure that the bottom, rear corners of the top are seated in their retaining clips.

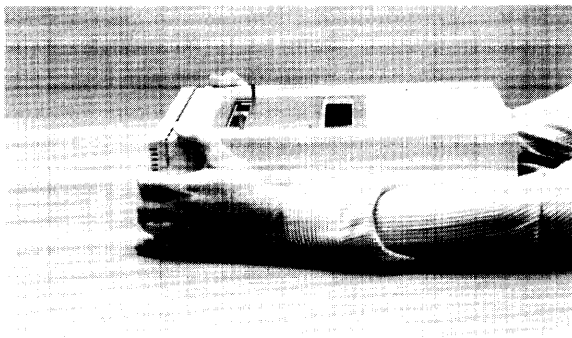

**Seating the Cover**

9. Locate the screw supplied in the bag with the power cord and install it into the front of the computer top.

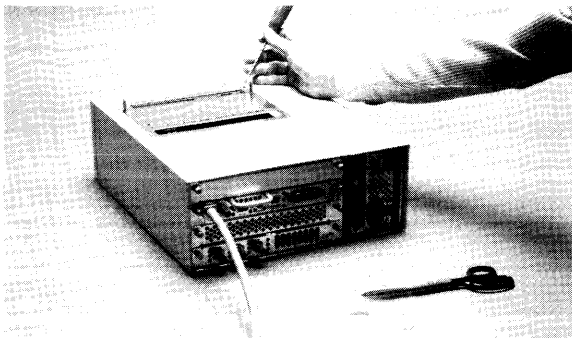

**Installing the Flat-head Screw**

10. Turn the Expander upside-down and locate the protective plastic sleeves on the backplane.
11. Remove the **inner** protective sleeve by sliding it out sideways.

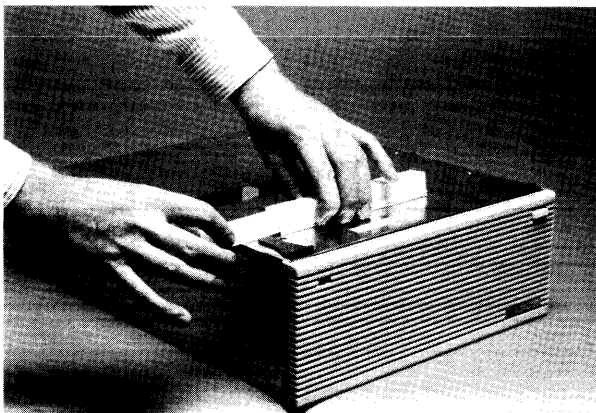

**Removing the Inner Sleeve**

12. Remove the **outer** protective sleeve by pinching it and rolling it forward.

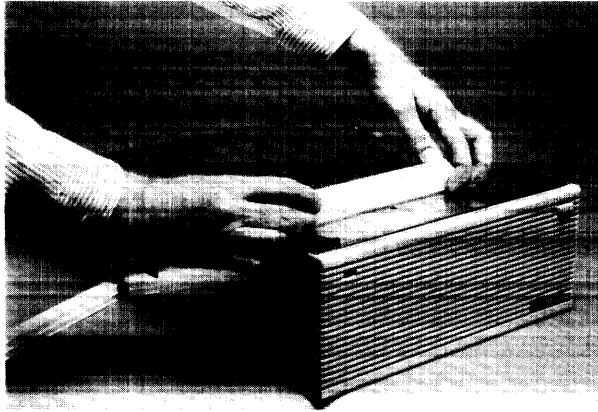

**Removing the Outer Sleeve**

13. Pick the Expander up and turn it right-side-up, holding it by the front and rear panels.



**Lifting the Expander**

14. Lower the Expander onto the computer, making sure that it is lined up front-to-back with your fingers and side-to-side visually.

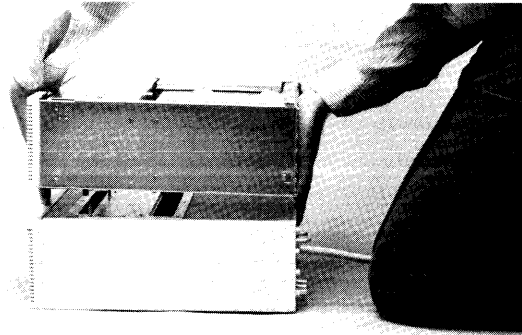

### Aligning the Expander and Computer

15. Press the Expander onto the two guide posts, then **gently** press it onto the connector.
16. Check to see that the connector is mating properly, then press the two together. If excessive force is needed, the alignment is not correct.
17. Now locate the two captive screws which fasten the Expander to the computer. They go through the Expander bottom and into the slotted top cover.

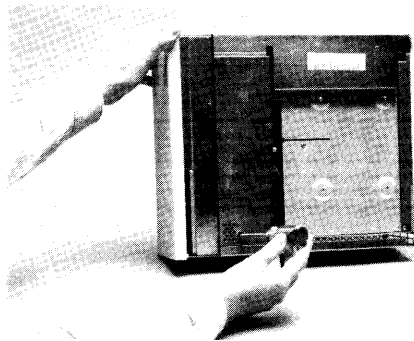

### Connecting Screw Holes

18. Tighten the two screws with a large, flat-blade screwdriver. Make sure they are tight, but don't overtighten them.
19. Install the computer top cover on the Expander. Start the front edge first, at a 45° angle.

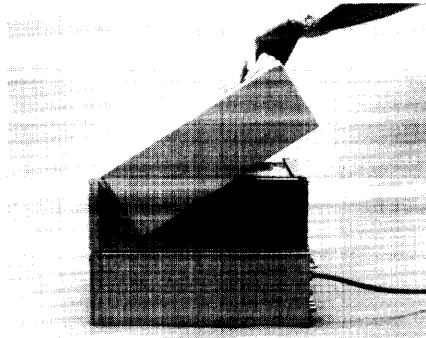

#### **Installing the Cover**

20. Press the cover down, then slide it forward. Make sure that the bottom, rear corners of the top are seated in their retaining clips.

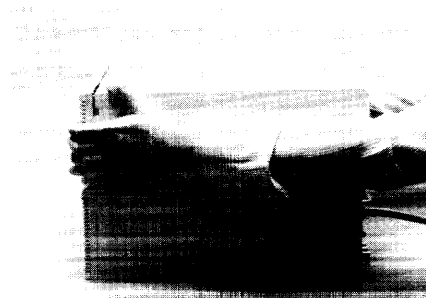

#### **Seating the Cover**

21. Re-install the power supply access doors on the computer and tighten the captive screws. Make sure that the “feet” on the bottom of the door are installed in their retaining slots.
22. Install the rear panel screw removed in step 6 on the Expander.
23. Connect the power cords to the computer and Expander. The combined units are now ready for testing.

## Verification Test

1. With a small, flat-blade screwdriver, loosen the two captive screws on the cover plate of slot 2 (that is, the second slot from the bottom), and remove the cover plate.

---

### NOTE

Do not loosen or remove any screws other than the captive screws on the slot cover plates. Also, do not change the position of the small RFI clips on the plates.

---

2. Turn power on to the Expander (but not to the computer).
3. A red LED located at the rear edge of the card in slot 1 should turn on and remain on.
4. Turn the computer on. The LED in step 3 should now turn off and remain off. (If you boot HP-UX and have the VME driver installed, the LED should come on again).
5. If these two don't happen, try again.

## Adding VMEbus Cards

The VMEbus Expander adheres to the specifications established by the VMEbus International Trade Association (VITA), revision C.1. VMEbus accessories which do not adhere to the VITA C.1 specification are not guaranteed to operate properly, if at all, in the VMEbus Expander.

Refer to the installation information that came with your VMEbus cards to properly install them in the VMEbus Expander.

---

## The Next Step

You have now installed the HP 98577A VMEbus Expander. Now move on to Step 3.



## Adding RAM

---

Follow this procedure if you have one of the following cards to install:

- An HP 98254A (64 Kbyte) RAM card
- An HP 98256A (256 Kbyte) RAM card
- An HP 98257A (1 Mbyte) RAM card
- An HP 98258A (4 Mbyte) parity RAM controller board
- An HP 98258B (4 Mbyte) parity RAM add-on board
- An HP 98258C (12 Mbyte) parity RAM add-on board
- An HP 98264A (8 Mbyte) Error Checking and Correcting (ECC) RAM card
- An HP 98264B (16 Mbyte) Error Checking and Correcting (ECC) RAM card

Otherwise, go to Step 4.

---

### Description

RAM cards add additional program memory to your computer. The maximum amount of RAM you can install in your computer is:

- All Series 200 computers: 7½ Mbytes.
- Series 300 Model 310 and 320 computers: 7½ Mbytes
- Series 300 Model 330 computer: 8 Mbytes
- Series 300 Model 350 computer: 32 Mbytes of parity RAM or 48 Mbytes of ECC RAM or combined ECC and parity RAM.

---

## Support

- HP 98254A: supported on Series 200 Model 216, 220, 226, 236 and 237 computers.
- HP 98256A and HP 98257A: supported on all Series 200 computers and on Series 300 Model 310 and 320 computers.
- HP 98258A: supported on Series 300 Model 330 and 350 computers.
- HP 98258B/C: supported on Series 300 Model 350 computers.
- HP 98264A/B: supported on Series 300 Model 350 computers.

---

## Before Starting the Installation

### The Expander

If your system does not already include an HP 98570A Backplane Expander, you may need to install and configure one in order to use this product. If you already have one, skip down to the next section.

Obviously, if all of the backplane slots in your computer are full, you will need an expander. If you need to install an expander, do not do so until you have turned the computer off in order to install the RAM hardware. Skip the rest of this section.

If you have a Model 350 computer, you will need an expander if either of these statements is true:

- Your video output board consists of two printed-circuit boards
- You have a total of more than four large boards.

If this condition exists, you will need an expander. If you do not know whether your video board contains two printed-circuit boards, check it by loosening the two screws securing it and sliding it out of the computer (make sure that your operating system is shut down and the computer turned off, first).

---

## Installing RAM Cards in Series 200 and Series 300 Model 310 and 320 Computers

This procedure describes how to install RAM cards in Series 200 computers and in Series 300 Model 310 and 320 computers. If you have a Series 300 Model 330 or 350 computer, refer to the following sections.

In this procedure, you will set the switches on each of your RAM cards to a unique setting. No two RAM cards may have their switches set the same way.

1. Follow the directions on one of the Memory Configuration Wheels to set the switches on your RAM cards:
  - If you have a Series 300 Model 310 or 320 computer, follow the procedure on the *Series 300 Memory Configuration Wheel*.
  - If you have a Series 200 computer, follow the procedure on the *Series 200 Memory Configuration Wheel*.

---

### NEED HELP?

Refer to the following section, “Help with the Memory Configuration Wheels.”

---

2. Once you have completed all instructions on the Memory Configuration Wheel, turn the computer on and check the number of bytes displayed on the screen. This number should be approximately equal to the total number of bytes of RAM you have installed in your computer. Count:
  - 1 048 000 bytes for each 1 Mbyte card you installed
  - 256 000 bytes for each 256 Kbyte card you installed
  - 64 000 bytes for each 64 Kbyte card you installed

3. If the number of bytes shown on the screen is:
  - **More than you expected:** don't be concerned—your computer probably contains some built-in RAM.
  - **Slightly less than you expected:** don't be concerned—your computer consumes a few hundred bytes of RAM as overhead.
  - **Significantly less than you expected:** repeat this procedure, and check for an increase in bytes after each card is installed.
4. Replace all cover plates on the back of your computer.

---

## Help with the Memory Configuration Wheels

This section provides advice for using the Memory Configuration Wheels. If you have trouble following a step, look up the step in this section and read the explanation.

Step 2-b (Series 300)

Step 2-b (Series 200)

Unscrew and remove the *painted* cover plates from the back of your computer. If your computer also has an interface card installed (i.e., a painted cover plate with a circuit board attached), remove this also—it may be covering a RAM card. Do not unscrew the *unpainted*, silver cover plates at the bottom of a Series 300 computer.

Once the cover plates are off, you may see some cards inside. Decide which of these cards are RAM cards by looking at the colors of their plastic extractor levers:

**Green** and **violet** extractor levers identify a 1 Mbyte RAM card.

**Red** and **yellow** extractor lever identify a 256 Kbyte RAM card.

**Two red** extractor levers identify a 64 Kbyte RAM card.

Remove all 1 Mbyte, 256 Kbyte and 64 Kbyte RAM cards by pulling their extractor levers toward you and sliding them out. RAM cards may be damaged by static discharge, so be careful not to touch the electrical components on the cards, and don't place them on a charged surface such as a carpet or cloth.

Step 2-d (Series 300)

If your screen remains blank, write down **0** and go on to Step 3.

- Step 2-e (Series 300) The Bytes window is immediately below Step 2 on the wheel. Turn the wheel until the number shown in the Bytes window approximates the number you wrote down in Step 2-d.
- Step 3 (Series 300)  
Step 3 (Series 200) Repeat this step for each 1 Mbyte RAM card you have. Do not go on to Step 4 until you have set the switches on all of your 1 Mbyte RAM cards.
- Step 3-c (Series 300)  
Step 3-b (Series 200) Turn the wheel until the next set of switches comes into view. **Whenever you are told to turn the wheel, always turn the wheel to the next set of switches.—never use a set of switches that is already in view.**
- For example, if you come to this step and a set of switches already appears in the window, you should turn the wheel past this set of switches and on to the next one. If you come to this step and an arrow appears in the window or the window is blank, you should turn the wheel until a set of switches comes into view.
- Step 3-d (Series 300)  
Step 3-c (Series 200) Set the switches on the RAM card to match those shown in the window.
- Step 3-e (Series 300) If you have additional 1 Mbyte RAM cards, begin again at Step 3-b to set the switches on the next 1 Mbyte RAM card. Remember to turn the wheel to the next set of switches when you repeat Step 3-c.
- If you have set the switches on all of your 1 Mbyte RAM cards, make sure your computer is turned off and re-insert all 1 Mbyte RAM cards into your computer. You may insert them into any slot, but be sure you do not use a slot which was previously occupied by an interface card (if you have one).
- Step 4 (Series 200) Repeat this step for each 256 Kbyte RAM card you have. Do not go on to Step 5 until you have set the switches on all of your 256 Kbyte RAM cards.
- Step 4-b (Series 200) See the advice for Step 3-b.
- Step 4-b (Series 300) Check that the number of bytes now shown on the screen has increased over the number you wrote down in Step 2-d.

- Step 4-c (Series 300) Turn the wheel clockwise until the number in the Bytes window approximates the number of bytes you see on the screen. If the number in the Bytes window is already be set correctly, you do not have to turn the wheel.
- Step 4-c (Series 200) See the advice for Step 3-c.
- Step 5-b (Series 200) See the advice for Step 3-b. Be sure you turn the wheel counter clockwise as indicated by the arrows on the edge of the wheel.
- Step 5-c (Series 300) See the advice for Step 3-c. Be sure you turn the wheel counter clockwise as indicated by the arrows on the edge of the wheel.
- Step 5-c (Series 200) See the advice for Step 3-c.
- Step 6-b (Series 200) See the advice for Step 3-b. Note that if an arrow appears in the window instead of a set of switches, you cannot use your remaining 64 Kbyte RAM cards. 64 Kbyte RAM cards can only be used in computers with less than 2 Mbytes of total RAM.
- Step 6-c (Series 200) See the advice for Step 3-c.

## Some Common Mistakes

If something goes wrong, watch out for these common mistakes:

- Whenever you are told to turn the wheel, be sure to turn it, even if a set of switches already appears in the window. Never use a set of switches unless you have just turned the wheel to bring it into view. Remember, no two RAM cards can have the same switch setting.
- When you use the back side of the wheel, don't forget to turn it counter clockwise, rather than clockwise.

---

## The Next Step

You have completed Step 3. Now move on to Step 4.

---

## Installing RAM Boards in Series 300 Model 330 Computers

This procedure describes how to install an HP 98258A RAM board in your Series 300 Model 330 computer. If you have a Series 200 computer, or a Series 300 Model 310 or 320 computer, refer to preceding sections. If you have a Series 300 Model 350 computer, see the following section.

---

### CAUTION

RAM boards can be easily damaged by static electricity. Be careful to handle them only by their edges and make sure you do **not** place them on a static-charged surface, such as a cloth or carpet. If possible, use a static-free workstation or place them on the anti-static envelope they were shipped in.

---

1. Carefully unpack your new RAM board.
2. Place your new RAM board, component-side up, on a static-free surface (e.g., the envelope your new RAM board was shipped in).
3. Set the switches on your new RAM board as shown in figure 3-1.

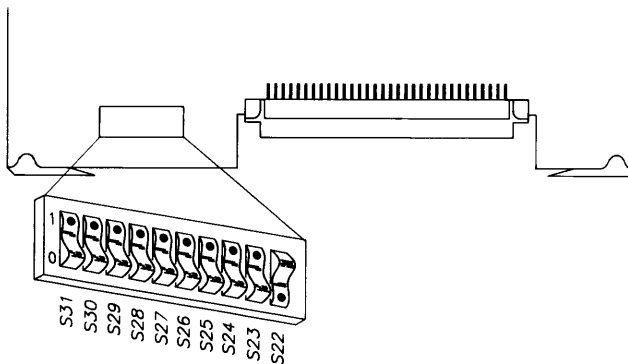

**Figure 3-1. Setting switches on the new HP 98258A RAM board**

4. Remove the cover plates on the back of your computer until you find a vacant slot.
5. Insert the new RAM board, component side up, into the vacant slot. Place the grey and green extractor levers against the board and push firmly until the board is securely seated in the backplane.
6. Replace the cover plates on the back of your computer.
7. Turn your computer on and hold down the space bar a few seconds. Check the display to make sure the amount of RAM in your computer has increased to *approximately* 8 Mbytes (8 338 608 bytes). See figure 3-2. If the memory reported is significantly less, check that the switches for your built-in RAM are set as shown in figure 3-3. Then double-check that your new RAM board's switches are set as shown in figure 3-1.

```
Copyright 1985.  
Hewlett-Packard Company.  
All Rights Reserved.
```

```
BOOTROM Rev. A2  
MC68020 Processor  
MC68881 Coprocessor  
Bit Mapped Display  
Keyboard  
HP-IB  
DMA-CO  
HP98644 at 9  
HP98625 at 14  
HP98643 at 20  
8338633 Bytes
```

**Figure 3-2. Display showing amount of RAM installed**



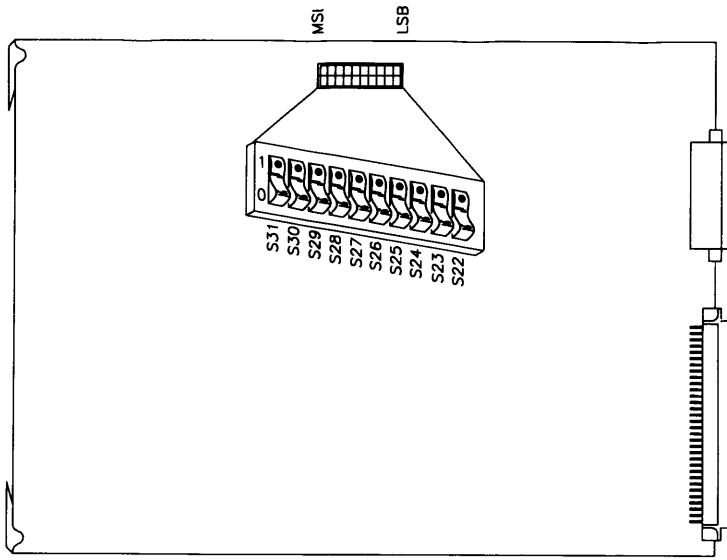

**Figure 3-3. Built-in RAM switch settings**

## Optimizing Model 330 Performance

The BASIC, Pascal and HP-UX operating systems occupy different areas of memory. Because programs occupying built-in RAM run faster than programs occupying add-on RAM, you may want to rearrange memory so that your most important programs occupy the fast, built-in RAM.

Here's what to do:

1. Select a program to use as a benchmark, or choose a commonly-used operating system function.
2. Run and time the benchmark program several times to determine its average execution time under the current RAM configuration.
3. **Turn your computer off.**

4. Remove the HP 98258A add-on RAM board. Reverse the switch settings of your add-on RAM board and your built-in RAM. When done, your built-in RAM should be set to:

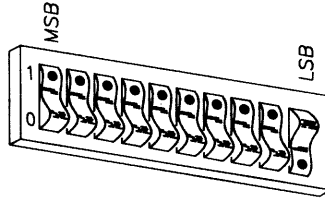

and your add-on RAM board should be set to:

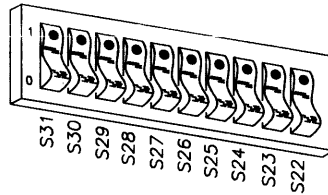

5. Re-insert your add-on RAM board into the computer.
6. Turn your computer on and hold down the space bar a few seconds. Verify that you still have 8 Mbytes of RAM installed by looking at the amount of RAM shown on the display.
7. Run your benchmark program several times to determine its average execute time.
8. Compare the program's performance under each RAM configuration and choose the fastest one.

---

## The Next Step

You have completed Step 3. Now move on to Step 4.

---

## Installing RAM Boards in Series 300 Model 350 Computers

This procedure describes how to install HP 98258A/B/C and 98264A/B boards in your Series 300 Model 350 computer. If you have a Series 200 computer, or a Series 300 Model 310, 320, or 330, refer to the preceding sections.

Before turning the computer off, invoke the power-up display (by doing a Reset).

```
Copyright 1985,  
Hewlett-Packard Company.  
All Rights Reserved.
```

```
B00TROM Rev. A2  
Bit Mapped Display  
MC68020 Processor  
MC68881 Coprocessor  
Keyboard  
HP-IB  
HP98620 DMA-CO  
HP98644 at 9  
HP98625 at 14  
HP98643 at 21  
XXXXXXX Bytes
```



### Power-up Display

Write down the amount of RAM listed: \_\_\_\_\_ Bytes. You will use this figure later to check that the new RAM board is correctly installed.

Now, shut down the operating system following normal HP-UX procedures (refer to your *System Administrator Manual* if you need more information).

Although installing RAM boards in the Model 350 is an easy task, it is broken down into three short pieces for your convenience:

1. Identifying which RAM boards are already in the computer.
2. Assigning the RAM board addresses.
3. Physically installing the new RAM board in the computer.

If you already know which RAM boards your computer contains, skip the section on “Identifying Existing RAM Boards” and go to the section on “Assigning the Addresses”.

If you know that your computer contains about 16 Mbytes of RAM (from the power-up display), go directly to the section titled, “Installing the RAM Board”. It includes all the information you will need to add the RAM board.

## Identifying Existing RAM Boards

In order to properly address a new board, you need to know the sizes of the boards already in the computer. If you already know what size boards are in the computer, put their quantities in this table and skip down to the section titled, “Assigning the Addresses”.

**RAM Board Inventory Table**

<b>Board Size</b>	<b>Quantity</b>
16 Mbyte boards	
8 Mbyte boards	
4 Mbyte boards	

If you do not know what sizes the RAM boards in your computer are, the easiest way to determine this information is to look at the amount of RAM in the power-up display (the figure you wrote down near the beginning of this section) and compare it to the number of boards in the backplane.

Now remove the system bus interface board and look for boards fitting this description:

<b>Extractor Colors (Left-Right)</b>	<b>Configuration</b>	<b>Memory Size</b>
Grey-Green	Single board Two-board pair	4 Mbytes 8 or 16 Mbytes
Blue-Yellow	Two-board pair	8 or 16 Mbytes

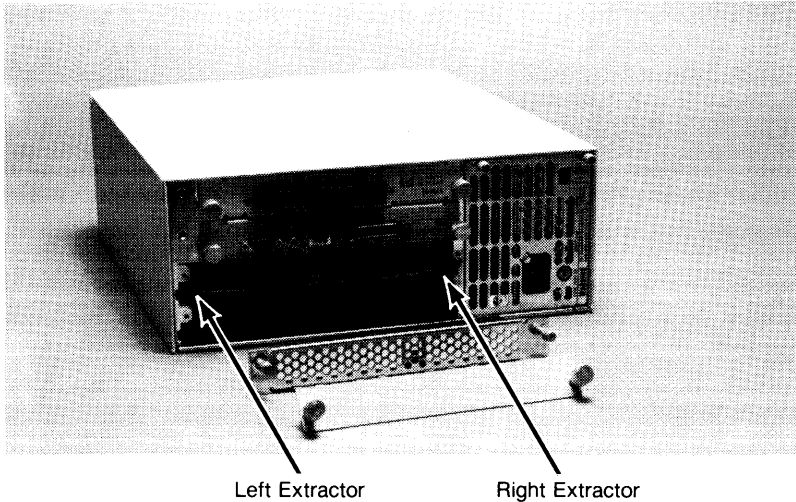

### RAM Memory Board Extractors

If you have a large number of boards and are still unable to determine what board sizes you have, you will have to use the part numbers of the boards. Carefully remove each board from the computer and locate the part number. It is located on the underside of the top board, immediately above the address switches on the bottom board.

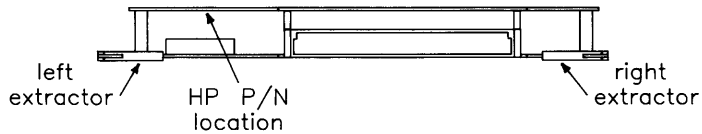

### Part Number Location

Identify the board size with this chart:

Extractor Colors Left-Right	Part Number	Memory Size
Grey-Green	none (Single board)	4 Mbytes
	98258-66521	8 Mbytes
	98258-66522	16 Mbytes
Blue-Yellow	98264-66521	8 Mbytes
	98264-66522	16 Mbytes

Put each board back into the computer when you have determined its size. You may wish to label the boards with their size, as you will need this information later.

When you have determined the sizes of all the RAM boards in the computer, you are ready to assign the address to the boards. If your system contains approximately 16 Mbytes in any combination, go directly to the section titled, "Installing the RAM Board". Otherwise, continue with the next section.

### **Assigning the Addresses**

The general rule to follow when addressing the RAM is that any board must be addressed higher in RAM space than any RAM board of smaller capacity and below any larger RAM. In practice, RAM being added to a computer is addressed below any existing RAM of the same size, in order to avoid having to readdress existing RAM boards. You will have to readdress any smaller RAM boards.

Although that is the general rule, there are some exceptions. For instance, if you have a 16 Mbyte system made up of 4 and 8 Mbyte boards, they can be treated as one 16 Mbyte board. The board to be added can then be addressed as if it were being placed below an existing 16 Mbyte board.

Addressing new RAM boards as well as readdressing smaller existing RAM boards are covered in this procedure.

1. Copy the numbers from the RAM Board Inventory Table in the section on "Identifying Existing RAM Boards" to this Table.

**RAM Board Inventory Table**

<b>Board Size</b>	<b>Quantity</b>
16 Mbyte boards	
8 Mbyte boards	
4 Mbyte boards	

- For each 16 Mbyte board already installed in the computer, cross off four of the 4 Mbyte blocks in this chart. Start with the first block and work down.

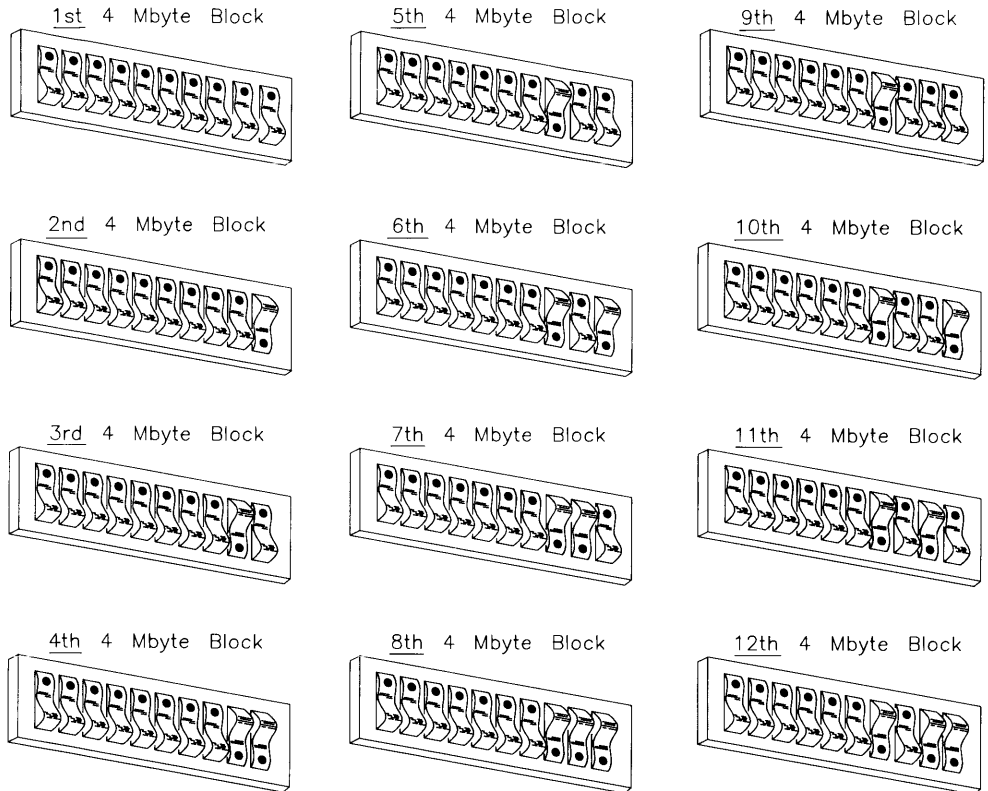

- If you are installing a 16 Mbyte RAM board, write the word “NEW” beside the next **UNUSED** block, and cross off the following **three** blocks.
- For each 8 Mbyte board in the computer, write the number “8” beside the next **UNUSED** block and cross off the following **one** block.
- If you are installing an 8 Mbyte RAM board, write the word “NEW” beside the next **UNUSED** block, and cross off the following **one** block.
- For each 4 Mbyte board in the computer, write the number “4” beside the next **UNUSED** block.
- If you are installing a 4 Mbyte RAM board, write the word “NEW” beside the next **UNUSED** block.

## An Example

If you would like to try out the addressing procedure before actually tackling your situation, run through the following example.

**The Situation:** You are adding a 16 Mbyte board to a computer already containing a 16 Mbyte board, an 8 Mbyte board and a 4 Mbyte board.

Here is how the 4 Mbyte block chart in Step 2 will look when you are finished:

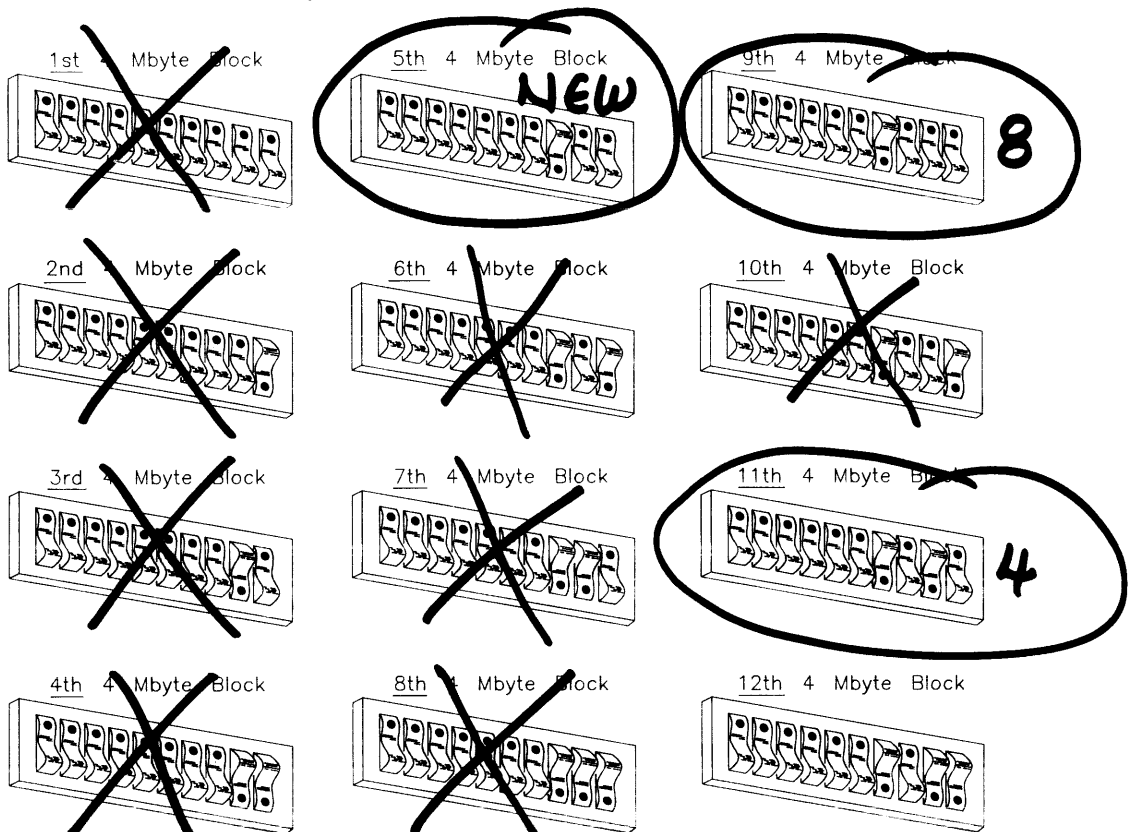

- In Step 2, blocks 1 thru 4 were crossed out.
- In Step 3, the word "NEW" was written by block 5 and blocks 6 thru 8 were crossed out.
- In Step 4, the number "8" was written by block 9 and block 10 was crossed out.
- In Step 6, the number "4" was written by block 11.



## Installing the RAM Board

If you will be installing an expander, go ahead and do so, using the instructions packaged with the expander.

If your computer contains a system bus, there are several configuration restraints.

Both parity and ECC RAM are normally installed in the computer chassis, since we strongly recommend that the RAM boards be connected to the processor board by the system bus for maximum performance. However, both RAM types may be installed in the expander if the resulting performance loss is acceptable to you.

The 4 Mbyte parity RAM board may be installed in any slot. The other RAM boards may be installed in any slot except for these:

- the top slot of either the computer or expander
- if your computer or expander contains DIO accessory slots (these are narrow slots toward the top of the chassis), they can not go in the slot immediately under the DIO slots.

---

### NOTE

You may have to temporarily loosen or remove the board or slot cover immediately above the empty slot in order to install the new RAM board. Make sure to retighten this board after installing the new board.

---

If your video output board consists of two printed circuit boards, it should go in the expander.

The processor board, the RAM boards and the Floating-Point Accelerator (if installed) should all be clustered together in the computer, in order to take advantage of the faster speed of the system bus.

If your computer is full, a good general rule is to move the video board to the expander.

Here is a step-by-step procedure for installing the new RAM board in your computer:

1. Make sure that the computer and expander are turned off and the power cords removed.
2. Loosen the screws holding the system bus connector board and remove it.

---

**CAUTION**

In the following steps, handle the circuit boards as little as possible.  
Handle them by the edges or backplate only.

---

3. Locate an empty system slot in the computer (or in the expander if you have chosen to put the new RAM there) and remove the cover plate from it.
4. If the empty slot is in the computer, check that it is immediately above or below the system bus connector board. If not, rearrange the boards so that it is.
5. Remove the new RAM board from its packaging material and place it on a static-free surface, such as the bag it was shipped in.
6. Locate the RAM address switches.

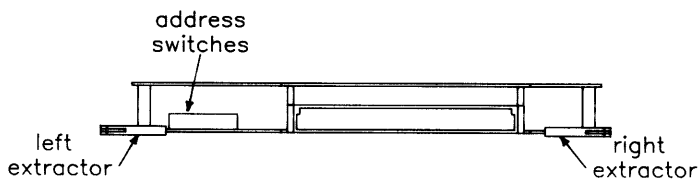

**RAM Board Address Switch Location**

7. If your system contains 16 Mbytes in any combination, set the address switches on the new board according to this diagram and then skip down to step 10:

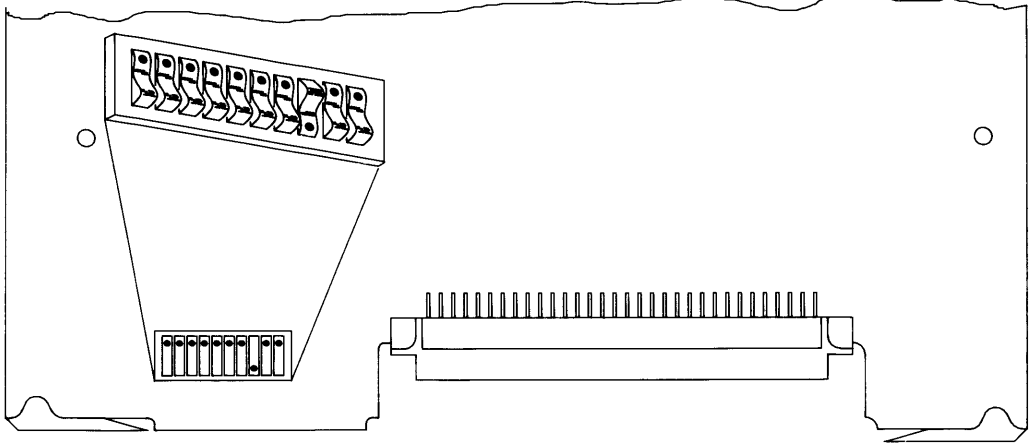

8. If your system contains other than 16 Mbytes, set the address switches on the new RAM board to match the block labelled "NEW".
9. Now change the address switches on all **SMALLER** boards to the ones numbered in the chart. "Smaller" refers to memory size rather than physical size. Note that boards the same size as or larger than the new board need not be changed. Only the smaller boards need new addresses.
10. Pick up the new RAM board by the edges and slide it into the empty slot. Slide the two-connector end in first, with the board with the connectors on the bottom.
11. If you installed the new RAM board in the expander, reinstall the cover plate over the slot and reinstall the system bus connector board removed in step 2. Then skip down to step 13.
12. Locate the new, larger system bus connector board packaged with the new RAM board and **carefully** install it onto the processor board and RAM board(s), and Floating-point Accelerator if installed.

---

#### NOTE

You **MUST** reinstall the system bus connector board to ensure system performance, provide needed air cooling and meet statutory requirements for fire safety and radiated emissions.

---

13. Reinstall the power cords and turn the computer and expander on.
14. Now check the power-up display for the amount of RAM installed.

Copyright 1985,  
Hewlett-Packard Company.  
All Rights Reserved.

BOOTROM Rev. A2  
Bit Mapped Display  
MC68020 Processor  
MC68881 Coprocessor  
Keyboard  
HP-IB  
HP98620 DMA-CO  
HP98644 at 9  
HP98625 at 14  
HP98643 at 21  
XXXXXXX Bytes

#### Power-up Display

Write the amount here \_\_\_\_\_Bytes.

15. If the amount of RAM in step 14 has not increased by approximately the amount of RAM you added, go to the section on **In Case of Trouble**.
16. Boot your HP-UX operating system as usual.

Your new RAM board is now installed.

---

## **In Case of Trouble**

If you do not obtain the correct amount of available memory, first turn the computer off and verify that the cards are plugged in correctly. Then turn it back on and see if the amount of memory is correct. If it still is not, turn the computer off and check the card addressing. If it is correct, set a card aside and continue the process with the remaining cards.

If you still have trouble, verify that you have assigned the addresses correctly. If you have, and no arrangement of cards will increase the amount of memory, put the computer into use with the maximum amount of memory you can obtain. Then replace all the unused cards in their anti-static bags and call your HP Sales and Service office for assistance.

---

## **The Next Step**

You have completed Step 3. Now move on to Step 4.



# 4

## Adding Accessory Cards

---

If you need to install any of the products listed below, turn to the indicated page number and follow the instructions. Otherwise, move on to Step 5.

<b>Card Name</b>	<b>Page Number</b>
HP 98248A Floating Point Accelerator	See page 4-8
HP 98556A 2D Graphics Accelerator	See page 4-12
HP 98603A BASIC 4.0 ROM Card	See page 4-6
HP 98620B DMA Controller Card	See page 4-2
HP 98635A Floating Point Math Card	See page 4-4

---

# Installing an HP 98620B DMA Controller Card

## Description

The HP 98620B Direct Memory Access (DMA) Controller Card provides two DMA channels for I/O transfer. This high speed I/O capability works with GPIO, HP-IB and Disc interfaces to increase the maximum data exchange rate between the computer and its peripherals.

After the computer sets up a direct memory transfer on the DMA Controller Card, the controller handles the transfer without further intervention from the computer. This frees the computer to do other things while the transfer continues automatically at the fastest transfer rate possible.

## Support

You can use the HP 98620B DMA Controller Card with any HP Series 200 computer with boot ROM 3.0 or later, or any Series 300 computer with boot ROM Rev. A or later.

Operating/Language system support is as follows:

- **BASIC:** supported on revision 2.0 (with extensions) or later with Series 200 computers; supported on revision 4.0 or later with Series 300 computers.
- **Pascal Workstation:** supported on revision 2.0 or later with Series 200 computers; supported on revision 3.1 or later with Series 300 computers.
- **HP-UX Operating System:** supported on revision 2.0 or later with Series 200 computers; supported on revision 5.0 or later with Series 300 computers.



## DMA Controller Card Installation Procedure

---

### NOTE

The DMA Controller Card *cannot* be installed in an HP 9888A Backplane Expander. It *can* be installed in an HP 98568A Backplane Expander, however.

---

1. **Turn your computer off.**
2. Remove the *painted* cover plates from the back of your computer until you find an empty slot. Do not remove the silver cover plates on the bottom of a Series 300 computer.
3. Select an empty odd-numbered slot for the DMA Controller Card if one is available; otherwise use an even-numbered slot. (Slots are numbered from the top down, so the top-most slot is number 1, the next slot down is number 2, etc.)
4. Insert the DMA Controller Card into the slot with the component side up. Using your thumbs, push on the extractor levers until the card is firmly seated in the backplane.
5. If you have additional cards to install in the backplane, leave the cover plates off; otherwise replace the cover plates.

### Verification Test

1. Turn your computer on and press the space bar a few times.
2. Check the list of components displayed on the left-hand side of the screen:
  - If the message, **HP98620B**, appears in the list, you have correctly installed the DMA Controller Card.
  - If the message above does not appear, repeat the installation procedure. If the message still does not appear, call your HP Service Representative for assistance.

### The Next Step

If you have another accessory card to install, lift the Step 4 tab and look up the page number of your next card's installation instructions. Otherwise, move on to Step 5.

---

# Installing HP 98635A Floating Point Math Card

## Description

The Floating Point Math Card (HP 98635A) enhances the performance of your computer and supports the proposed IEEE standard for binary floating point numbers. With this card, computational performance can be increased up to three times. Actual performance is highly dependent on the application, language, and operating system.

## Support

You can use the HP 98635A Floating Point Math Card with any HP Series 200 or Series 300 computer.

Operating system support is as follows:

- **BASIC:** supported on revision 3.0 or later with Series 200 computers; supported on revision 4.0 or later with Series 300 computers.
- **Pascal Workstation:** supported on revision 3.0 or later with Series 200 computers; supported on revision 3.1 or later with Series 300 computers.
- **HP\_UX Operating System:** supported on revision 2.1 or later with Series 200 computers; supported on revision 5.0 or later with Series 300 computers.

## Floating Point Math Card Installation Procedure

---

### NOTE

The Floating Point Math Card may be installed in the HP 9888A Bus Expander, but with reduced performance. Installation in an HP 98568A Backplane Expander will not reduce performance.

---

1. **Turn your computer off.**
2. Remove the *painted* cover plates from the back of your computer until you find an empty slot. Do not remove the silver cover plates on the bottom of a Series 300 computer.

3. Select an empty odd-numbered slot for the Floating Point Math Card if one is available; otherwise use an even-numbered slot. (Slots are numbered from the top down, so the top-most slot is number 1, the next slot down is number 2, etc.)
4. Insert the Floating Point Math Card into the slot with the component side up. Using your thumbs, push on the extractor levers until the card is firmly seated in the backplane.
5. If you have additional cards to install in the backplane, leave the cover plates off; otherwise replace the cover plates.

## **Verification Test**

1. Turn your computer on and press the space bar a few times.
2. Check the list of components displayed on the left-hand side of the screen:
  - If the message, **HP98635**, appears in the list, you have correctly installed the Floating Point Math Card.
  - If the message above does not appear, repeat the installation procedure. If the message still does not appear, call your HP Service Representative for assistance.

## **The Next Step**

If you have another accessory card to install, lift the Step 4 tab and look up the page number of your next card's installation instructions. Otherwise, move on to Step 5.

---

# Installing the HP 98603A BASIC 4.0 ROM Card

## Description

The HP 98603A BASIC 4.0 ROM Card contains the following system components:

- The BASIC 4.0 “core” language system.
- All driver binaries except DCOMM and SRM.
- All language extension binaries except KNB2\_0.

## Support

You can use the HP 98603A BASIC 4.0 ROM Card with both Series 200 and Series 300 computers.

## BASIC 4.0 ROM Card Installation Procedure

1. **Turn your computer off.**
2. Remove the *painted* cover plates from the back of your computer until you find an empty slot. Do not remove the silver cover plates on the bottom of a Series 300 computer.
3. Select an empty odd-numbered slot for the BASIC 4.0 ROM Card if one is available; otherwise use an even-numbered slot. (Slots are numbered from the top down, so the top-most slot is number 1, the next slot down is number 2, etc.)
4. Set the switches:
  - If you have a Series 300 computer, set the switches like this:

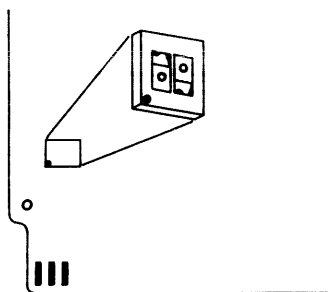

- If you have a Series 200 computer, set the switches like this:

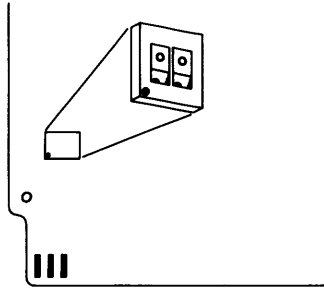

5. Insert the BASIC 4.0 ROM Card into the slot with the component side up. Using your thumbs, push on the extractor levers until the card is firmly seated in the backplane.
6. If you have additional cards to install in the backplane, leave the cover plates off; otherwise replace the cover plates.

## Verification Test

1. Turn your computer on.
2. Look for the following message at the bottom of the screen:

**BASIC Ready 4.0**

- If the message appears, you have correctly installed the BASIC 4.0 ROM Card.
- If the message does not appear, repeat the installation procedure, making sure the switches are set correctly. If the message still does not appear, call your HP Service Representative for assistance.

## The Next Step

If you have another accessory card to install, lift the Step 4 tab and look up the page number of your next card's installation instructions. Otherwise, move on to Step 5.

---

# Installing an HP 98248A Series 300 Floating-Point Accelerator

## Description

The HP 98248A Floating-Point Math board set provides HP Series 300 32-bit computers with high-speed floating-point hardware.

## Support

You can use the HP 98248A Series 300 Floating-Point Accelerator with any 32-bit Series 300 computer except the Model 318 (e.g., Models 330 and 350).

Operating system support is as follows:

- **BASIC:** not supported.
- **Pascal Workstation:** not supported.
- **HP-UX Operating System:** supported on revision 5.5 or later.

## Floating-Point Accelerator Installation Procedure

---

### NOTE

Installing the Floating-Point Accelerator involves two tasks:

- preparing the operating system for the new hardware
- physically installing the hardware.

This procedure describes how to install the hardware *only*. For instructions on preparing the operating system to use the hardware, refer to the installation note that came with the Floating-Point Accelerator.

---

If your system does not already include a backplane expander, you may need to install and configure one in order to use this product. If you already have one, skip the next section.

If you know that you will need to install an expander, go ahead and do so, using the instructions packaged with the expander. Then skip the next section.

### **The Expander**

You will need an expander if either of these statements is true:

1. You have no empty system slots in your computer.
2. Your video output board consists of two printed circuit boards.

If either of these conditions is true, you will need an expander, and the video board must be placed in it. If you do not know whether your video board contains two printed-circuit boards, check it by loosening the two screws securing it and sliding it out of the computer.

### **The System Bus**

The hardware installation process can take either of two paths, depending upon whether your computer has a System Bus. An installation procedure for each is presented here. Go to the correct procedure. For example, the Model 350 has a System Bus, the Model 330 does not.

If you do not know whether your computer has a System Bus, look at the rear panel of the computer. The System Bus is a metal plate covering two or more slots. If your computer has such a plate, refer to the procedure titled, "With a System Bus". Otherwise, refer to the procedure titled, "Without a System Bus".

## **With a System Bus**

1. Make sure that the computer and expander are turned off and the power cords removed.

---

### **CAUTION**

In the following steps, handle the circuit boards as little as possible. Handle them by the edges or backplate only.

---

2. Locate an empty system slot in the computer, either by moving the video board to the expander or by removing the cover plate from an empty slot.
3. Check that the empty slot is next to the System Bus. If it is not, rearrange the boards so that it is.
4. Remove the Floating-Point Accelerator board set from the packaging material and slide it into the empty slot. Slide the two-connector end in first, with the board with the connectors on the bottom.
5. Loosen the screws holding the System Bus and remove it.
6. Locate the new, larger System Bus packaged with the Floating-Point Accelerator and install it onto the Accelerator, processor board and RAM board(s).

---

### **NOTE**

You **MUST** reinstall the System Bus to ensure system performance, provide needed air cooling and meet statutory requirements for fire safety and radiated emissions.

---

7. Reinstall the power cords and turn the computer and expander on.



## Without a System Bus

1. Make sure that the computer and expander are turned off and the power cords removed.

---

### CAUTION

In the following steps, handle the circuit boards as little as possible. Handle them by the edges or backplate only.

---

2. Locate an empty system slot in the computer, either by moving the video board to the expander or by removing the cover plate from an empty slot.
3. Remove the Floating-Point Accelerator board set from the packaging material and slide it into the empty slot. Slide the two-connector end in first, with the board with the connectors on the bottom.
4. Reinstall the slot cover plate removed in step 2.

---

### NOTE

You **MUST** install the slot cover plate to provide needed air cooling and meet statutory requirements for fire safety and radiated emissions.

---

5. Reinstall the power cords and turn the computer and expander on.

## The Next Step

If you have another accessory card to install, lift the Step 4 tab and look up the page number of your card's installation instructions. Otherwise, move on to Step 5.

---

# Installing the HP 98556A 2D Graphics Accelerator

## Description

The HP 98556A 2D Graphics Accelerator is an add-on option for the HP 98549A and HP 98550A Color Video Boards. It resides piggy back on the video board. The board pair fits into one slot in the Series 300 computer or Direct-Connect I/O Expander.

---

### NOTE

If you have an HP 98264A/B ECC RAM card or an HP 98248A Floating-Point Accelerator card mounted in your computer, the HP 98556A 2D Graphics Accelerator card *must* be mounted in the Direct-Connect I/O Expander.

---

## Support

The HP 98556A 2D Graphics Accelerator is supported on Series 300 Model 330 and 350 computers.

Operating/Language system support is as follows:

- **BASIC:** not supported.
- **Pascal Workstation:** not supported.
- **HP-UX Operating System:** supported on revision 6.0 or later.

## HP 98556A 2D Graphics Accelerator Installation Procedure

1. **Play It Safe.**
  - a. Turn your computer off and unplug the power cord.
  - b. Remove the Graphics Accelerator from its envelope, being careful to handle the card only by its non-connector edges. The card may be easily damaged by electrostatic discharge (static zap).
  - c. Place the card on its envelope, or use a static-free workstation, HP part number 9300-0933..
2. Remove the video (RGB) cable from the video board.
3. Remove the video board and place it on a static-free surface.
4. Insert the Graphics Accelerator into the connector on the video board. Make sure it is firmly seated.
5. Turn the board pair so that the video board is facing up and the Graphics Accelerator is facing down. Insert and tighten the three screws that correspond with stand-offs on the Graphics Accelerator. Then turn the assembly over and insert and tighten the fourth screw in the hole corresponding with the stand-off on the video board.
6. Install the board pair into the expander or computer. Make sure it is firmly seated into the connector.
7. Connect the video cable.
8. Connect the power cord to the computer.

---

### The Next Step

If you have another accessory card to install, lift the Step 4 tab and look up the page number of your next card's installation instructions. Otherwise, move on to Step 5.



---

## Select Code Record

Record your interface in the third column of this table, according to the select code used. If you did not change the select code switches, the interface has the factory setting shown in the second column. **No two interfaces may have the same select code.**

Select Code	Interface(s) With This Factory Setting	Your Interface Setting
7	Built-in HP-IB	Built-in HP-IB
8	HP 98624A	
9	Built-in RS-232 <sup>1</sup> , HP 98626A, 98644A	
10	(Unused)	
11	HP 98623A	
12	HP 98622A	
13	HP 98642A	
14	HP 98625A/B, 98265A	
15	(Unused)	
16	(Unused)	
17	(Unused)	
18	HP 98640A	
19	(Unused)	
20	HP 98628A	
21	HP 50961A, 98629A, 98643A	
22	HP 98695A	
23	(Unused)	
24	(Unused)	
25	HP 98287A	
26	(Unused)	
27	HP 98253A	
28	HP 98627A	
29	HP 98627A, 98633A	
30	HP 98259A	
31	HP 98287A (HP-HIL)	

<sup>1</sup> For Model 216, 217, and Series 300 computers (called "Data Communications" on the 216/217).

## Adding Interface Cards

If you need to install any of the products listed below, turn to the indicated page number and follow the instructions. Otherwise, move on to Step 6.

<b>Interface Card Name</b>	<b>Page Number</b>
HP 98253A EPROM Programmer Interface	See page 5-2
HP 98265A Small Computer Systems Interface	See page 5-130
HP 98287A Graphics Display Station Interface	See page 5-7
HP 98546A Display Compatibility Interface	See page 5-14
HP 98548/49/50A High Resolution Video Boards	See page 5-120
HP 98562-66530 Human (System) Interface Board	See page 5-109
HP 98622A GPIO Interface	See page 5-19
HP 98623A BCD Input Card	See page 5-26
HP 98624A HP-IB Interface	See page 5-30
HP 98625A Disc Interface	See page 5-36
HP 98625B Disc Interface	See page 5-42
HP 98626A RS-232C Interface	See page 5-49
HP 98627A Color Output Interface	See page 5-59
HP 98628A Datacomm Interface	See page 5-65
HP 98629A and HP 50961A SRM Interfaces	See page 5-75
HP 98633 Multiprogrammer Interface	See page 5-78
HP 98640A Analog Input Card	See page 5-83
HP 98642A 4-Channel Multiplexer Interface	See page 5-88
HP 98643A LAN Interface	See page 5-94
HP 98644A RS-232C Serial Interface	See page 5-97
HP 98695A IBM 3270 Coax Interface	See page 5-104
HP 98724A/25A Local Graphics Bus Interface	See page 5-126

---

# Installing the HP 98253A EPROM Programmer Interface

## Description

The HP 98253A EPROM Programmer Interface allows you to program EPROM devices that have been loaded onto an HP 98255A EPROM Memory Card.

## Support

You can use the HP 98253A EPROM Programmer Interface with HP Series 200 Model 217, 220, 226, 236, and 237 computers with boot ROM 3.0 or later, and with any Series 300 computer with boot ROM Rev. A or later.

Operating/language system support is as follows:

- **BASIC:** supported on revision 2.1 or later with Series 200 computers; supported on revision 4.0 or later with Series 300 computers.
- **Pascal Workstation:** supported on revision 3.0 or later with Series 200 computers; supported on revision 3.1 or later with Series 300 computers.
- **HP-UX Operating System:** not supported.

## EPROM Programmer Interface Installation Procedure

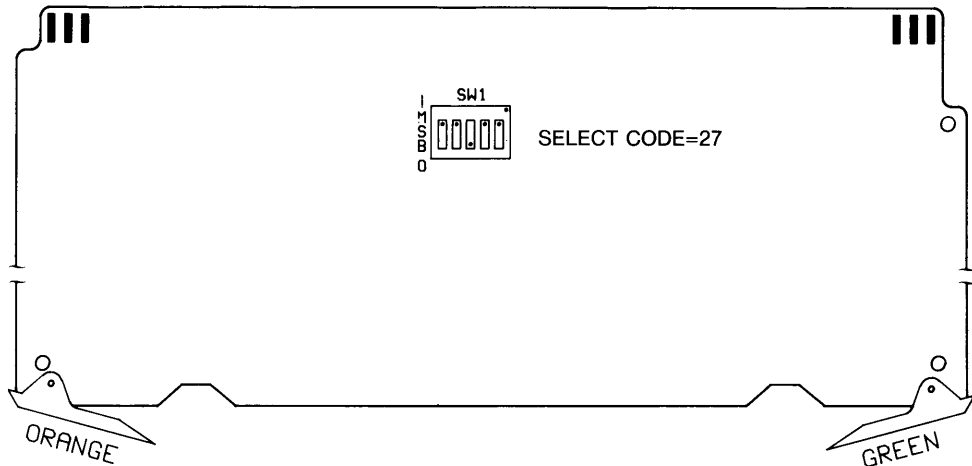

**Figure 5-1. EPROM Programmer Interface select code switches.**

### 1. Play It Safe.

- a. Turn your computer off and unplug the power cord.
- b. Remove the EPROM Programmer Interface from its envelope, being careful to handle the card only by its edges and plastic extractor levers. The card may be damaged by electrostatic discharge (static zap).
- c. Place the card on the envelope.



## 2. Set the Select Code.

---

### CAN YOU SKIP THIS STEP?

If this is the first (or only) EPROM Programmer Interface you are installing, you can skip to step 3. The select code is preset to 27 and need not be changed.

---

- a. Find the set of five switches labeled SW1 on the EPROM Programmer Interface (see Figure 5-1).
- b. Set these switches to one of the four select codes given below, unless you have used them elsewhere. Refer to the manual that came with the interface if you need additional switch settings.

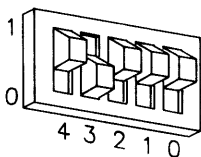

**Select Code 23**

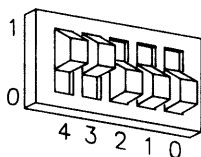

**Select Code 24**

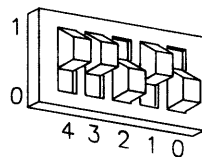

**Select Code 26**

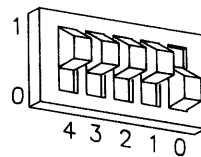

**Select Code 30**

## 3. Insert the Interface.

- a. Remove the *painted* cover plates from the back of your computer until you find an empty slot. **Do not** remove the silver cover plates from the bottom of a Series 300 computer.
- b. Insert the EPROM Programmer Interface, component side up, into the empty slot.
- c. Place the extractor levers flat against the card, and push on the extractor levers with your thumbs until the card is firmly seated in the backplane. You may have to push very hard.
- d. If you have other interface or accessory cards to install, leave the cover plates off; otherwise, replace them.

#### 4. Record the Select Code.

- a. Make a note that select code 27 (or the alternate select code you chose in step 2) has been used and is no longer available. Use the “Select Code Record” form on the Step 5 tab for this purpose.

---

#### NOTE

Installation of HP 98255A EPROM Memory Cards is covered in Step 6, “Adding Mass Storage Devices.”

---

### Verification Test

1. Plug in the power cord and turn your computer on. If you have systems on-line that the computer can boot, press the space bar a few times to suspend the automatic booting process.
2. Check the list of components displayed on the left-hand side of the screen:
  - If the message, **HP98253 at select code**, appears in the list, you have correctly installed the first EPROM Programmer Interface.
  - If the message above does not appear, repeat the installation procedure, making sure that no two interfaces have the same select code and that the card is firmly seated in its slot. If the message still does not appear, call your HP Service Representative for assistance.

---

## The Next Step

You have now installed the EPROM Programmer Interface.

The following “Worksheet Entries” contain information needed to use the EPROM Programmer Interface with various language/operating systems. Refer to the table for the system you’ll be using.

Copy this information to a worksheet (worksheets are found at the end of Step 1) or simply remember to refer here when you need it. **If you changed the select code in step 2-b, write in your new select code instead of 27.**

When finished, you’ll be ready to install your next peripheral or interface.

---

## BASIC System Worksheet Entry

Interface Name	Select Code	Driver Name
HP 98253A	27	EPROM

---

## Pascal Workstation Worksheet Entry

Interface Name	Select Code	Module Name
HP 98253A	27	EDRIVER & EPROMS

---

### NOTE

Before you can access the HP 98253A EPROM Programmer Interface from the Pascal Workstation, you must make a few modifications. See the Special Configurations chapter of the *Pascal Workstation System* manual for details.

---

---

# Installing the HP 98287A Graphics Display Station Interface

## Description

The HP 98287A Graphics Display Station Interface provides a connection between the computer and the HP 98700 Graphics Display Station.

## Support

You can use the HP 98287A Graphics Display Station Interface with any Series 300 computer.

Operating/Language system support is as follows:

- **BASIC:** supported on revision 4.0 or later.
- **Pascal Workstation:** supported on revision 3.1 or later.
- **HP-UX Operating System:** supported on revision 5.0 or later.

## Graphics Display Station Interface Installation Procedure

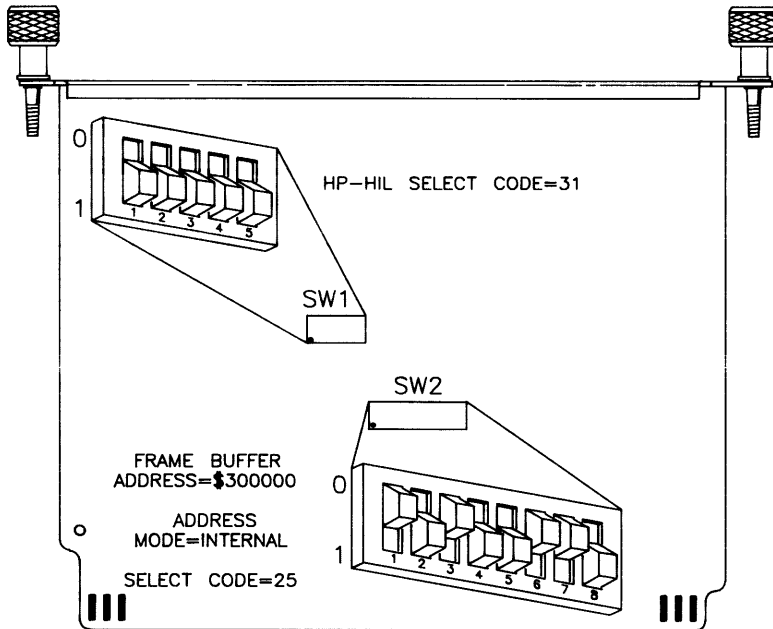

**Figure 5-2. Graphics Display Station Interface switches.**

### 1. Play It Safe.

- a. Turn your computer off and unplug the power cord.
- b. Remove the Graphics Display Station Interface from its envelope, being careful to handle the card only by its edges and metal end plate. The card may be easily damaged by electrostatic discharge (static zap).
- c. Place the card on the envelope.

## 2. Set the HP-HIL Select Code.

---

### NOTE

The Graphics Display Station's HP-HIL Interface is not currently supported by any Series 300 operating system. Therefore, you do not need to change the HP-HIL select code switches (SW1), even if you have two Graphics Display Stations. Leave them set to 31, as shown in Figure 5-2, and go on to step 3.

---

## 3. Set the Frame Buffer Address.

---

### CAN YOU SKIP THIS STEP?

If this is the first (or only) Graphics Display Station Interface you are installing, you can skip to step 4. Your frame buffer address is preset to \$300000 (in hexadecimal), as shown in Figure 5-2, and need not be changed.

---

- a. Find the set of eight switches labeled SW2 on the Graphics Display Station Interface (see Figure 5-2). Switches 1 and 2 in this group determine the frame buffer address.
- b. Set these switches to one of the following values, keeping these restrictions in mind:
  - If you have both a Graphics Display Station *and* a Series 300 bit-mapped display, **do not** use frame buffer address \$200000.
  - If you have a Model 320 computer, **do not** use frame buffer address \$800000 or \$900000.

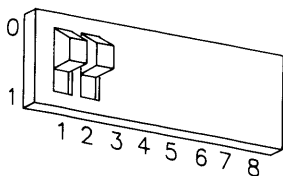

Address \$200000

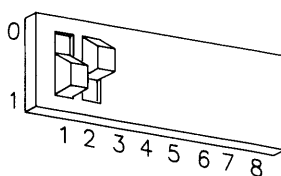

Address \$800000

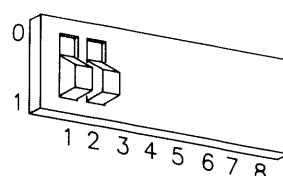

Address \$900000

#### 4. Set the Addressing Mode

- a. Find the set of eight switches labeled SW2 on the Graphics Display Station Interface (see Figure 5-2). Switch 3 in this group determines the addressing mode.
- b. Set switch 3 as follows:
  - If you want to use the Graphics Display Station as the system console, or if it is your *only* bit-mapped system display, set switch 3 to **0**, as shown in Figure 5-2 (see Important! note below). This places the Graphics Display Station at *internal address* \$560000 (in hexadecimal). If you have two Graphics Display Stations, only one of them may be set to internal addressing mode.

---

#### IMPORTANT!

If you use internal addressing mode (switch 3 = 0), you cannot also use a Series 300 bit-mapped display connected to a Model 310 built-in video output, or to an HP 98542/43/44/45A video card. (You *can* use a monitor connected to an HP 98546A Display Compatibility Interface, however.)

You **must** disable your Model 310 built-in video output, and/or remove your HP 98542/43/44/45A video card. See your *Installation Reference* manual for details.

To use both a Graphics Display Station and a Series 300 bit-mapped display, you must use external addressing mode (switch 3 = 1) as indicated below.

---

- To use the Graphics Display Station as a graphics output device *only*, set switch 3 to **1**, which is opposite the setting shown in Figure 5-2. This places the Graphics Display Station at the *external address* (i.e., select code) specified in the next step.

## 5. Set the Graphics Display Station Select Code.

---

### CAN YOU SKIP THIS STEP?

If this is the first (or only) Graphics Display Station you are installing, you can skip to step 6. The select code is preset to 25 and need not be changed.

---

- a. Find the set of eight switches labeled SW2 on the Graphics Display Station Interface. Switches 4 through 8 in this group determine the interface's select code.
- b. Set these switches to one of the four select codes given below, unless you have used them elsewhere. Refer to the installation note that came with the interface if you need additional switch settings.

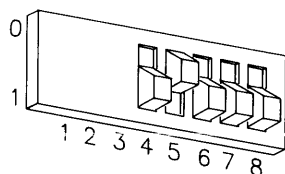

**Select Code 23**

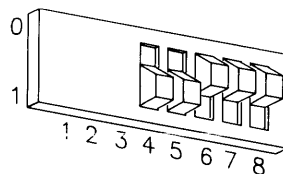

**Select Code 24**

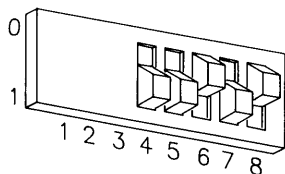

**Select Code 26**

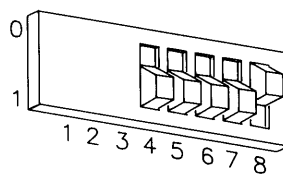

**Select Code 30**

## 6. Insert the Interface.

- a. Remove the *painted* cover plates from the back of your computer until you find an empty *even-numbered* slot. (Slots are numbered from the top down, so the top-most slot is number 1, the next slot down is number 2, etc.) **Do not** remove the silver cover plates from the bottom of a Series 300 computer.
- b. Insert the Graphics Display Station Interface, component side up, into the empty even-numbered slot. Tighten the thumb screws on the metal end plate until the end plate is flush with the back of the computer.



- c. If you changed the select code of the Graphics Display Station Interface in step 5, find this number in the set of select code labels supplied with the interface. Affix this label to the metal end plate.
- d. If you have other interface or accessory cards to install, leave the cover plates off; otherwise, replace them.

#### 7. Record the Select Code.

- a. Make a note that select code 25 (or the alternate select code you chose in step 5) and select code 31 have been used and are no longer available. Use the "Select Code Record" form on the Step 5 tab for this purpose.

---

#### NOTE

Graphics Display Station installation is covered in Step 8, "Adding Plotters and Other Graphics Devices."

---

---

## The Next Step

You have now installed the Graphics Display Station Interface.

The following "Worksheet Entries" contain information needed to use the Graphics Display Station Interface with various language/operating systems. Refer to the table for the system you'll be using. (Note that BASIC has two entries: one if the interface was set to external addressing mode in step 4-b, and another if it was set to internal addressing mode. Choose only one entry.)

Copy this information to a worksheet (worksheets are found at the end of Step 1) or simply remember to refer here when you need it. **If you changed the select code in step 5-b, write in your new select code instead of 25.**

When finished, you'll be ready to install your next peripheral or interface.

---

## BASIC System Worksheet Entry

### External Addressing Mode

Interface Name	Select Code	Driver Name
HP 98287A	25 <sup>1</sup>	_ <sup>2</sup>

### Internal Addressing Mode

Interface Name	Select Code	Driver Name
HP 98287A	1 & 6	CRTB

---

## Pascal Workstation Worksheet Entry

Interface Name	Select Code	Module Name
HP 98287A	25	CRTC & CRTD

---

### NOTE

The modules required for the HP 98287A Graphics Display Station Interface (CRTC and CRTD) are already present on the *BOOT2* disc. No system modifications are required.

---

---

## HP-UX System Worksheet Entry

Interface Name	Select Code
HP 98287A	25

---

<sup>1</sup> If you have no other internal display, also enter **1** here.

<sup>2</sup> If you have no other internal display, enter **CRTB** here.

---

# Installing the HP 98546A Display Compatibility Interface

## Description

The HP 98546A Display Compatibility Interface converts digital display data from Series 300 computers into a composite video signal which is compatible with HP 35721, HP 35731, and HP 35741 monitors. It requires two adjacent slots in the backplane and the lower slot must be an I/O card (i.e., even-numbered) slot.

The interface consists of two cards: a video card with an attached metal end plate, and a graphics card that connects to the video card through a short ribbon cable.

## Support

The HP 98546A Display Compatibility Interface is supported on any Series 300 computer.

Operating/Language system support is as follows:

- **BASIC:** supported on revision 4.0 or later.
- **Pascal Workstation:** supported on revision 3.1 or later.
- **HP-UX Operating System:** supported on revision 5.0 or later, but it must be the only display in the system.

## Display Compatibility Interface Installation Procedure

1. **Play It Safe.**
  - a. Turn your computer off and unplug the power cord.
  - b. Remove the Display Compatibility Interface from its envelope, being careful to handle the card only by its edges and metal end plate. The card may be easily damaged by electrostatic discharge (static zap).
  - c. Place the card on the envelope.

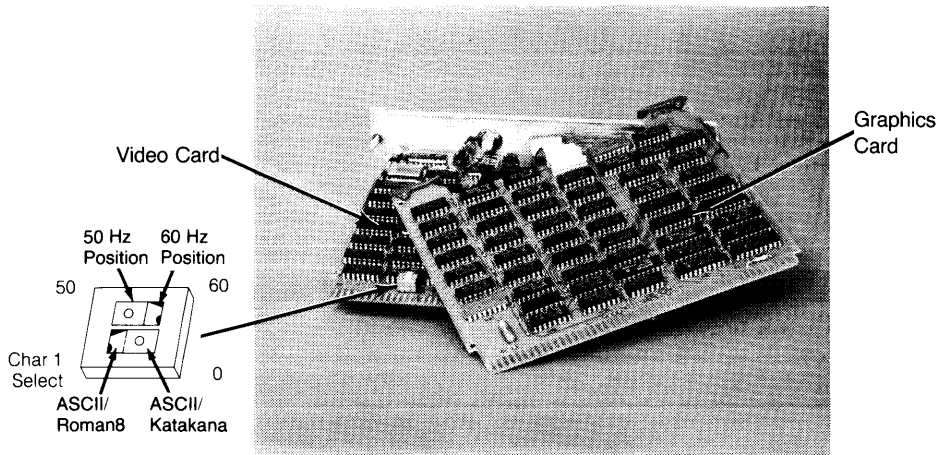

**Figure 5-3. Display Compatibility Interface switches.**

**2. Set the 50/60 Hz Switch.**

---

**CAN YOU SKIP THIS STEP?**

This switch is preset to 60 Hz. If your power frequency is 60 Hz, or if you don't know your power frequency, you can skip to step 3. If you later notice a problem with your screen, come back and change the Hz setting.

---

- a. Find the 50/60 Hz switch on the video card (see Figure 5-3).
- b. Set the 50/60 Hz switch to the desired setting by referring to Figure 5-3.

**3. Set the Character Select Switch.**

---

**CAN YOU SKIP THIS STEP?**

If you are not using Japanese characters, you can skip to step 4. The character select switch is preset to ASCII/Roman 8 and need not be changed.

---

- a. Find the character select switch on the video card (see Figure 5-3).
- b. Set the character select switch to ASCII/Roman 8 or ASCII/Katakana by referring to Figure 5-3.

#### 4. Insert the Interface.

- a. If the graphics and video cards are not already connected together, plug the ribbon cable connector on the graphics card cable into the matching connector on the video card. The connector is designed so you cannot insert it backwards.
- b. Remove the *painted* cover plates from the back of your computer until you find two adjacent empty slots. The bottom slot must be an *even-numbered* slot. (Slots are numbered from the top down, so the top-most slot is number 1, the next slot down is number 2, etc.) **Do not** remove the silver cover plates from the bottom of a Series 300 computer.
- c. Hold the interface with the graphics card above the video card. Make sure the components are facing up.
- d. Keeping the graphics card slightly ahead of the video card, slide the cards into adjacent accessory slots as shown in Figure 5-4.

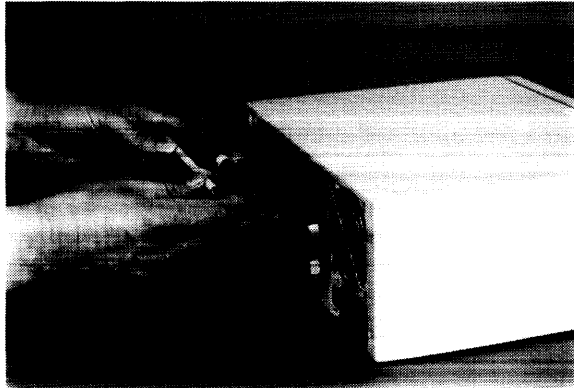

**Figure 5-4. Installing the interface.**

- e. Using your thumbs, press the graphics (top) card into its slot first. When it is securely seated in its slot, its extractor levers will be even with the back of the computer frame.

- f. Place the ribbon cable between the two cards, then tighten the thumb screws on the metal end plate until the end plate is flush with the back of the computer.

---

## The Next Step

You have now installed the Display Compatibility Interface.

The following “Worksheet Entries” contain information needed to use the Display Compatibility Interface with various language/operating systems. Refer to the table for the system you’ll be using.

Copy this information to a worksheet (worksheets are found at the end of Step 1) or simply remember to refer here when you need it.

When finished, you’ll be ready to install your next peripheral or interface.

---

## BASIC System Worksheet Entry

Interface Name	Select Code	Driver Name
HP 98546A	1 or 3	CRTA & CRTB <sup>1</sup>

### BASIC Notes

- If you also have a Series 300 bit-mapped display or an HP 98700 Graphics Display Station set to internal addressing mode, you can execute the following BASIC CONTROL statement to send alpha output to the Display Compatibility Interface:

```
CONTROL CRT,21;1
```

To turn off alpha output to the Display Compatibility Interface, execute:

```
CONTROL CRT,21;0
```

- To use the monitor connected to the Display Compatibility Interface as a graphics device, execute:

```
PLOTTER IS 3
```

---

## Pascal Workstation Worksheet Entry

Interface Name	Select Code	Module Name
HP 98546A	1	CRT & CRTC <sup>2</sup>

---

## HP-UX System Worksheet Entry

Interface Name	Select Code
HP 98546A	-

---

<sup>1</sup> CRTB is needed if using a bit-mapped display.

<sup>2</sup> CRTC is needed if bit-mapped graphics are present.

---

# Installing the HP 98622A GPIO Interface

## Description

HP 98622A General Purpose Input/Output (GPIO) Interface card is used for a wide variety of peripheral requirements. It supports 16-bit bi-directional data exchange. Extended control and status lines are available for applications that require more than one signal from the computer. Several handshake modes are also available to permit interfacing to a variety of equipment.

## Support

You can use the HP 98622A GPIO Interface with any HP Series 200 or Series 300 computer.

Operating/language system support is as follows:

- **BASIC:** supported on revision 1.0 with Series 200 computers; supported on revision 4.0 or later with Series 300 computers.
- **Pascal Workstation:** supported on revision 1.0 or later with Series 200 computers; supported on revision 3.1 or later with Series 300 computers.
- **HP-UX Operating System:** not supported with Series 200 computers; supported on revision 5.0 or later with Series 300 computers.



# GPIO Interface Installation Procedure

The GPIO Interface may be configured in any number of ways depending on the requirements of your application. Abbreviated instructions are provided here; refer to the installation manual that came with the interface if you need more information.

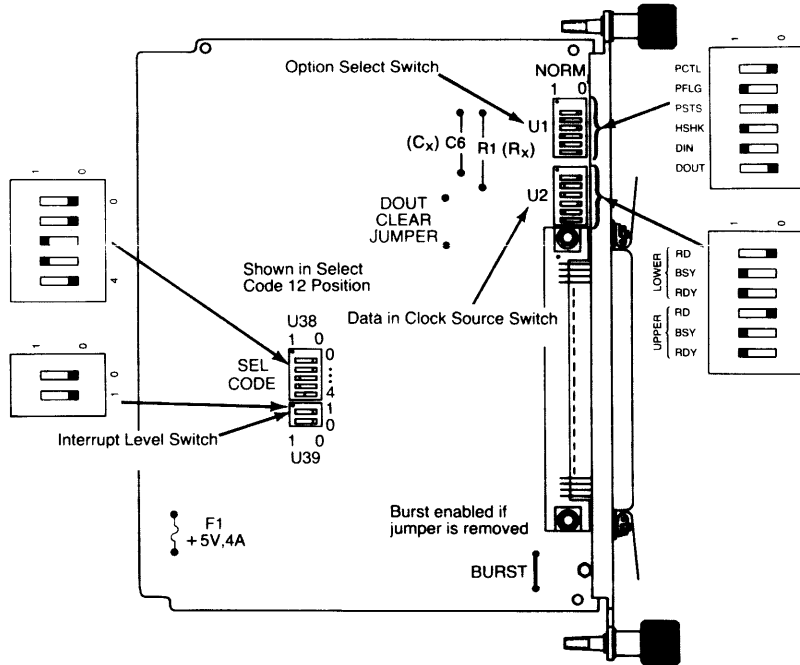

**Figure 5-5. HP 98622A GPIO Switches and Jumpers**

## 1. Play It Safe.

- a. Turn your computer off and unplug the power cord.
- b. Remove the GPIO Interface from its envelope, being careful to handle the card only by its edges and metal end plate. The card may be easily damaged by electrostatic discharge (static zap).
- c. Place the card on the envelope.

## 2. Set the Select Code.

---

### CAN YOU SKIP THIS STEP?

If this is the first (or only) GPIO Interface you are installing, you can skip to step 3. The select code is preset to 12 and need not be changed.

---

- a. Find the set of five switches labeled U38 on the GPIO Interface (see Figure 5-5). This group of switches determines the select code.
- b. Set these switches to one of the four select codes given below, unless you have used them elsewhere. Refer to the installation note that came with the interface if you need additional switch settings.

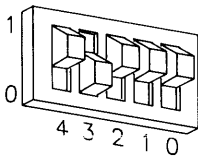

**Select Code 23**

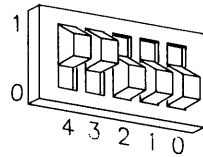

**Select Code 24**

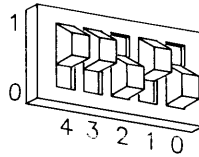

**Select Code 26**

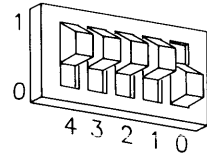

**Select Code 30**

## 3. Set Other Configuration Switches.

- a. Set Interrupt Level switch, labeled U39 on the card, to interrupt level 3 (00) as shown in Figure 5-5 (interrupt level 3 is required for HP-UX). If your application requires a different setting, refer to the following table.

Interrupt Level	Switches	
	1	0
3	0	0
4	0	1
5	1	0
6	1	1

- b. Set the Data-in Clock Source switches (labeled U2). If connecting an HP 9884A Paper Tape Punch to this interface, set these switches as shown in Figure 5-5.

The right-hand 3 switches set the clock source for the data input lines DI0 through DI7. The left-hand 3 switches set the clock source for the data input lines DI8 through DI15. Select only one clock source (logic 0) for each group of input lines. The three clock sources are:

- **RD.** This mode causes the data to be clocked into the input register when the register is read. It accomplishes this by clocking the leading edge of the output enable signal of the register.
  - **BSY.** This mode clocks the data into the data input register by a ready-to-busy transition of the PFLG line. This transition also clears the PCTL line.
  - **RDY.** This mode clocks the data into the data input register by a busy-to-ready transition of the PFLG line.
- c. Set the Option Select switches (labeled U1) by referring to the following table. If connecting an HP 9884A Paper Tape punch to this interface, set all of these switches to **1**.

Switch Position Name	Function	Logic 1 (Switch Open)	Logic 0 (Switch Closed)
DOUT	Invert Data Out	Low = 1 High = 0	Low = 0 High = 1
DIN	Invert Data In	Low = 1 High = 0	Low = 0 High = 1
HSBK	Full/Pulse Handshake	Full	Pulse
PSTS	Invert PSTS	Low = $\overline{OK}$ High = OK	Low = OK High = $\overline{OK}$
PFLG	Invert PFLG	Low = Rdy High = Bsy	Low = Bsy High = Rdy
PCTL	Invert PCTL	Low = set High = Clr	Low = Clr High = Set

- d. Install or remove the jumpers on your HP 98622A card(s) as required by your peripheral.
  - **DOUT CLEAR Jumper.** With the jumper installed, both data output registers are cleared at power up and after an interface reset. With the jumper removed, contents of the register are undefined. The card is shipped without the jumper. If you intend to use the HP 9884A Paper Tape Punch with this interface, the jumper should be in.
  - **BURST Jumper.** With the jumper installed, there is better overall system performance, but slightly slower GPIO performance on high-speed transfers. With the removed, there is slightly degraded overall system performance, but better GPIO performance for transfers greater than 100K transfers/second. The card is shipped with the jumper. If you intend to use the HP 9884A Paper Tape Punch with this interface, the jumper should be removed.
- e. Adjust the PCTL Delay if required. The PCTL line has a built in delay of 250ns. To increase the delay, increase the value of C6 40pF per 100ns of additional delay. To decrease the delay, decrease the value of R1 1.47k ohms per 100ns of decreased delay.

#### 4. Insert the Interface.

- a. Remove the *painted* cover plates from the back of your computer until you find an empty *even-numbered* slot. (Slots are numbered from the top down, so the top-most slot is number 1, the next slot down is number 2, etc.) **Do not** remove the silver cover plates from the bottom of a Series 300 computer.
- b. Insert the GPIO Interface, component side up, into the empty even-numbered slot. Tighten the thumb screws on the metal end plate until the end plate is flush with the back of the computer.
- c. If you changed the select code of the GPIO Interface in step 2, find this number in the set of select code labels supplied with the interface. Affix this label to the metal end plate.
- d. If you have other interface or accessory cards to install, leave the cover plates off; otherwise, replace them.

#### 5. Record the Select Code.

- a. Make a note that select code 12 (or the alternate select code you chose in step 2) has been used and is no longer available. Use the "Select Code Record" form on the Step 5 tab for this purpose.

## Verification Test

1. Plug in the power cord and turn your computer on. If you have systems on-line that the computer can boot, press the space bar a few times to suspend the automatic booting process.
2. Check the list of components displayed on the left-hand side of the screen:
  - If the message, **HP98622**, appears in the list, you have correctly installed the GPIO Interface.
  - If the message above does not appear, repeat the installation procedure, making sure there are no select code conflicts and that the card is firmly seated in an even-numbered slot. If the message still does not appear, call your HP Service Representative for assistance.

---

## The Next Step

You have now installed the GPIO Interface.

The following “Worksheet Entries” contain information needed to use the GPIO Interface with various language/operating systems. Refer to the table for the system you’ll be using.

Copy this information to a worksheet (worksheets are found at the end of Step 1) or simply remember to refer here when you need it. **If you changed the select code in step 2-b, write in your new select code instead of 12.**

When finished, you’ll be ready to install your next peripheral or interface.

---

## BASIC System Worksheet Entry

Interface Name	Select Code	Driver Name
HP 98622A	12	GPIO

---

## Pascal Workstation Worksheet Entry

Interface Name	Select Code	Module Name
HP 98622A	12	GPIO

---

### NOTE

Before you can access the HP 98622A GPIO Interface from the Pascal Workstation, you must make a few modifications. See the Special Configurations chapter of the *Pascal Workstation System* manual for details.

---

---

## HP-UX System Worksheet Entry

Interface Name	Select Code
HP 98622A	12

### HP-UX Notes

- The character-mode major number for the Device I/O Library GPIO Interface driver is 22.
- The minor number for a GPIO Interface at select code 12 is 0x0c0000.
- A typical *mknod* for a GPIO Interface at select code 12 is:

```
# mknod /dev/gpio c 22 0x0c0000
```

The 0c in the minor number represents select code 12 (0c is hexadecimal for 12).

---

# Installing the HP 98623A BCD Interface

## Description

The HP 98623A Binary Coded Decimal (BCD) Interface connects the computer with bit parallel, binary coded decimal devices for data input. It is supplied with an unterminated cable for connection to a wide variety of devices. Up to eight BCD digits, two sign bits (mantissa and exponent), exponent digit, function code digit, and an overload bit can be read. Input format is selectable, allowing two independent instruments to be read from one interface card. Data can also be read as five input bytes of pure binary information. Eight control and/or data output lines are provided.

## Support

You can use the HP 98623A BCD Interface with any HP Series 200 or Series 300 computer.

Operating/language system support is as follows:

- **BASIC:** supported on revision 1.0 or later with Series 200 computers; supported on revision 4.0 or later with Series 300 computers.
- **Pascal Workstation:** not supported.
- **HP-UX Operating System:** not supported.

## BCD Interface Installation Procedure

1. **Play It Safe.**
  - a. Turn your computer off and unplug the power cord.
  - b. Remove the BCD Interface from its envelope, being careful to handle the card only by its edges and metal end plate. The card may be easily damaged by electrostatic discharge (static zap).
  - c. Place the card on the envelope.

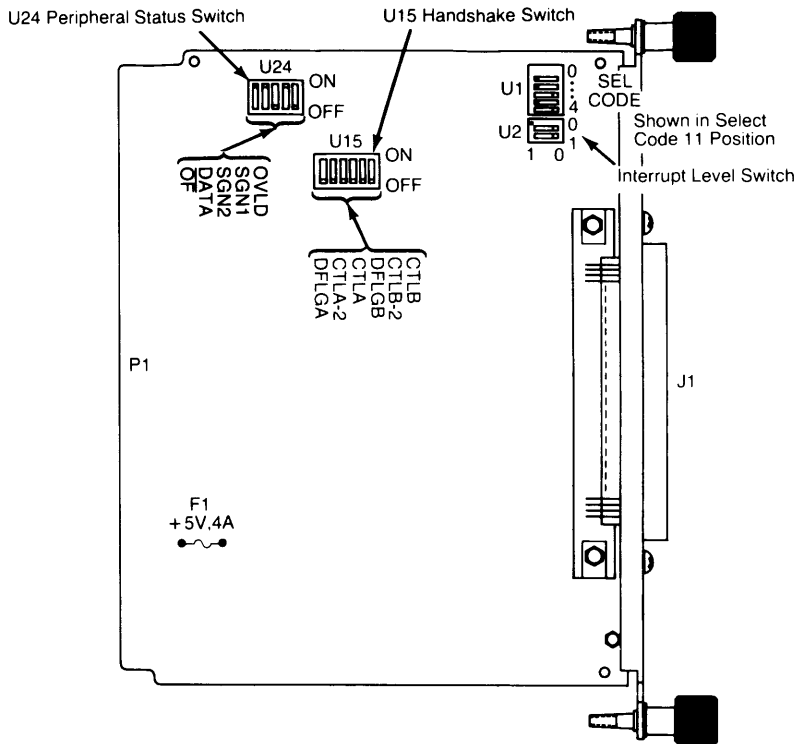

**Figure 5-6. HP 98623A BCD Interface switches.**

**2. Set the Select Code.**

---

**CAN YOU SKIP THIS STEP?**

If this is the first (or only) BCD Interface you are installing, you can skip to step 3. The select code is preset to 11 and need not be changed.

---

- a. Find the set of five switches labeled U1 on the BCD Interface (see Figure 5-6). This group of switches determine the interface's select code.



- b. Set these switches to one of the four select codes given below, unless you have used them elsewhere. Refer to the installation note that came with the interface if you need additional switch settings.

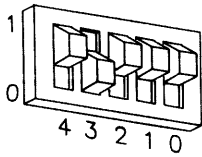

Select Code 23

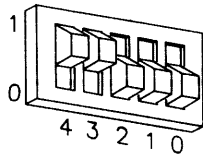

Select Code 24

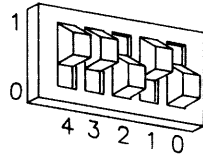

Select Code 26

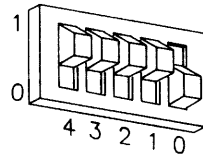

Select Code 30

### 3. Set Other Configuration Switches.

- Set the Interrupt Level switches, labeled U2 on the card, to interrupt level 3 (00) as shown in Figure 5-6.
- The remaining configuration switch settings are dependent on your particular application. Refer to the installation note that came with the BCD interface and to your peripheral documentation for instructions.

### 4. Insert the Interface.

- Remove the *painted* cover plates from the back of your computer until you find an empty *even-numbered* slot. (Slots are numbered from the top down, so the top-most slot is number 1, the next slot down is number 2, etc.) **Do not** remove the silver cover plates from the bottom of a Series 300 computer.
- Insert the BCD Interface, component side up, into the empty even-numbered slot. Tighten the thumb screws on the metal end plate until the end plate is flush with the back of the computer.
- If you changed the select code of the BCD Interface in step 2, find this number in the set of select code labels supplied with the interface. Affix this label to the metal end plate.
- If you have other interface or accessory cards to install, leave the cover plates off; otherwise, replace them.

### 5. Record the Select Code.

- Make a note that select code 11 (or the alternate select code you chose in step 2) has been used and is no longer available. Use the "Select Code Record" form on the Step 5 tab for this purpose.

## Verification Test

1. Plug in the power cord and turn your computer on. If you have systems on-line that the computer can boot, press the space bar a few times to suspend the automatic booting process.
2. Check the list of components displayed on the left-hand side of the screen:
  - If the message, **HP98623**, appears in the list, you have correctly installed the BCD Interface.
  - If the message above does not appear, repeat the installation procedure, making sure there are no select code conflicts and that the card is firmly seated in an even-numbered slot. If the message still does not appear, call your HP Service Representative for assistance.

---

## The Next Step

You have now installed the BCD Interface.

The following “Worksheet Entry” contains information needed to use the BCD Interface with the BASIC Language System.

Copy this information to a worksheet (worksheets are found at the end of Step 1) or simply remember to refer here when you need it. **If you changed the select code in step 2-b, write in your new select code instead of 11.**

When finished, you’ll be ready to install your next peripheral or interface.

---

## BASIC System Worksheet Entry

Interface Name	Select Code	Driver Name
HP 98623A	11	BCD

---

# Installing the HP 98624A HP-IB Interface

## Description

The HP 98624A HP-IB Interface card implements the IEEE 488-1978 Standard Digital Interface for Programmable Instrumentation. The interface can communicate with as many as 14 HP-IB compatible instruments, connected with a maximum of 20 meters of cable (65.6 ft.). It has interrupt capabilities and can carry out DMA transfers via the optional DMA Controller card.

It is a “normal” or “standard” speed HP-IB interface.

## Support

You can use the HP 98624A HP-IB Interface with any HP Series 200 or Series 300 computer.

Operating/language system support is as follows:

- **BASIC:** supported on revision 1.0 or later with Series 200 computers; supported on revision 4.0 or later with Series 300 computers.
- **Pascal Workstation:** supported on revision 1.0 or later with Series 200 computers; supported on revision 3.1 or later with Series 300 computers.
- **HP-UX Operating System:** supported on revision 2.0 or later with Series 200 computers; supported on revision 5.0 or later with Series 300 computers.

## HP-IB Interface Installation Procedure

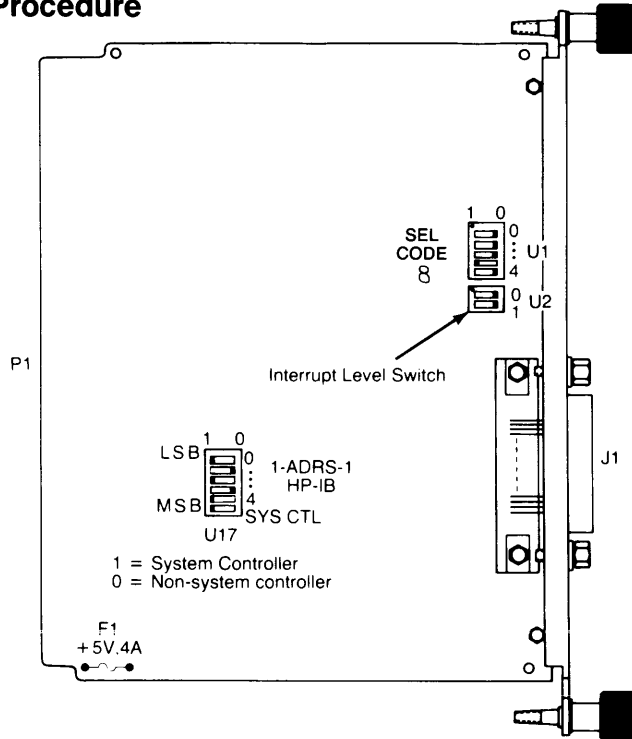

**Figure 5-7. HP 98624A HP-IB Interface switches.**

### 1. Play It Safe.

- Turn your computer off and unplug the power cord.
- Remove the HP-IB Interface from its envelope, being careful to handle the card only by its edges and metal end plate. The card may be easily damaged by electrostatic discharge (static zap).
- Place the card on the envelope.

## 2. Set the Select Code.

---

### CAN YOU SKIP THIS STEP?

If this is the first (or only) HP 98624A HP-IB interface you are installing, you can skip to step 3. The select code is preset to 8 and need not be changed.

---

- a. Find the set of five switches labeled U1 on the HP-IB Interface (see Figure 5-7). This group of switches determine the interface's select code.
- b. Set these switches to one of the four select codes given below, unless you have used them elsewhere. Refer to the installation note that came with the interface if you need additional switch settings.

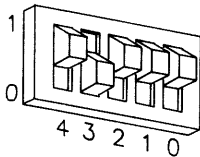

Select Code 23

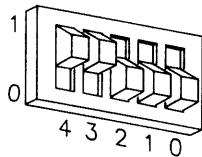

Select Code 24

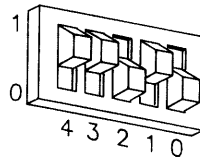

Select Code 26

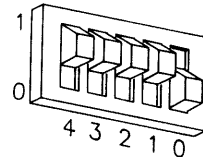

Select Code 30

## 3. Set the Interrupt Level.

---

### CAN YOU SKIP THIS STEP?

The interface is preset to interrupt level 3. Unless you are certain that interrupt level 3 is inappropriate for your application, leave the interrupt level setting alone and skip to step 4.

---

- a. If you need to change the interrupt level, refer to Figure 5-7 and set the switches labeled U2 according to the following table:

Interrupt Level	Switches	
	1	0
3	0	0
4	0	1
5	1	0
6	1	1

#### 4. Set the Address and System Controller Switches.

---

##### CAN YOU SKIP THIS STEP?

Unless you intend to connect two computers together with this interface, you can skip to step 5. The interface is configured to be system controller at address 21 and need not be changed.

---

- a. If connecting two computers together via HP-IB, only one of them may be set to address 21. To change the address of this interface, reset switches 0 thru 4 in the group of switches labeled U17 (see Figure 5-7). As an example, to change the address from the default setting of 21 to a new setting of 20, just change switch 0 in this group to **0** (the opposite of that shown).
- b. If connecting two computers together via HP-IB, only one of them may be set to system controller. To change this interface to non-system controller, move the SYS CTL switch shown in Figure 5-7 to the 0 position (the opposite of that shown).

**Note:** If you will be connecting a disc drive, printer, plotter or other peripheral to this interface, *and* you will be using an HP Series 200/300 operating system, **do not** set this switch to non-system controller.

#### 5. Insert the Interface.

- a. Remove the *painted* cover plates from the back of your computer until you find an empty *even-numbered* slot. (Slots are numbered from the top down, so the top-most slot is number 1, the next slot down is number 2, etc.) **Do not** remove the silver cover plates from the bottom of a Series 300 computer.
- b. Insert the HP-IB Interface, component side up, into the empty even-numbered slot. Tighten the thumb screws on the metal end plate until the end plate is flush with the back of the computer.
- c. If you changed the select code of the HP-IB Interface in step 2, find this number in the set of select code labels supplied with the interface. Affix this label to the metal end plate.
- d. If you have other interface or accessory cards to install, leave the cover plates off; otherwise, replace them.

## 6. Record the Select Code.

- a. Make a note that select code 8 (or the alternate select code you chose in step 2) has been used and is no longer available. Use the “Select Code Record” form on the Step 5 tab for this purpose.

## Verification Test

1. Plug in the power cord and turn your computer on. If you have systems on-line that the computer can boot, press the space bar a few times to suspend the automatic booting process.
2. Check the list of components displayed on the left-hand side of the screen:
  - If the message, **HP98624**, appears in the list, you have correctly installed the HP-IB Interface.
  - If the message above does not appear, repeat the installation procedure, making sure there are no select code conflicts and that the card is firmly seated in an even-numbered slot. If the message still does not appear, call your HP Service Representative for assistance.

---

## The Next Step

You have now installed the HP-IB Interface.

The following “Worksheet Entries” contain information needed to use the HP-IB Interface with various language/operating systems. Refer to the table for the system you’ll be using.

Copy this information to a worksheet (worksheets are found at the end of Step 1) or simply remember to refer here when you need it. **If you changed the select code in step 2-b, write in your new select code instead of 8.**

When finished, you’ll be ready to install your next peripheral or interface.

---

## BASIC System Worksheet Entry

Interface Name	Select Code	Driver Name
IIP 98624A	8	HPIB

---

## Pascal Workstation Worksheet Entry

Interface Name	Select Code	Module Name
HP 98624A	8	HPIB

---

## HP-UX System Worksheet Entry

Interface Name	Select Code
HP 98624A	8



---

# Installing the HP 98625A Disc Interface

---

## NOTE

If you have an HP 98625B Disc Interface, see the next section.

---

### Description

The HP 98625A Disc Interface provides a high-speed HP-IB interface to Command Set 80 (CS/80) discs. The Disc Interface is capable of handling up to four discs on one interface card. A DMA Controller card is required for the Disc Interface to achieve optimum performance.

### Support

You can use the HP 98625A Disc Interface with any HP Series 200 computer with boot ROM 3.0 or later, or with any Series 300 computer with boot ROM Rev A. or later.

Operating/language system support is as follows:

- **BASIC:** supported on revision 2.1 or later with Series 200 computers; supported on revision 4.0 or later with Series 300 computers.
- **Pascal Workstation:** supported on revision 2.0 or later with Series 200 computers; supported on revision 3.1 or later with Series 300 computers.
- **HP-UX Operating System:** supported on revision 2.0 or later with Series 200 computers; supported on revision 5.0 or later with Series 300 computers.

## HP 98625A Disc Interface Installation Procedure

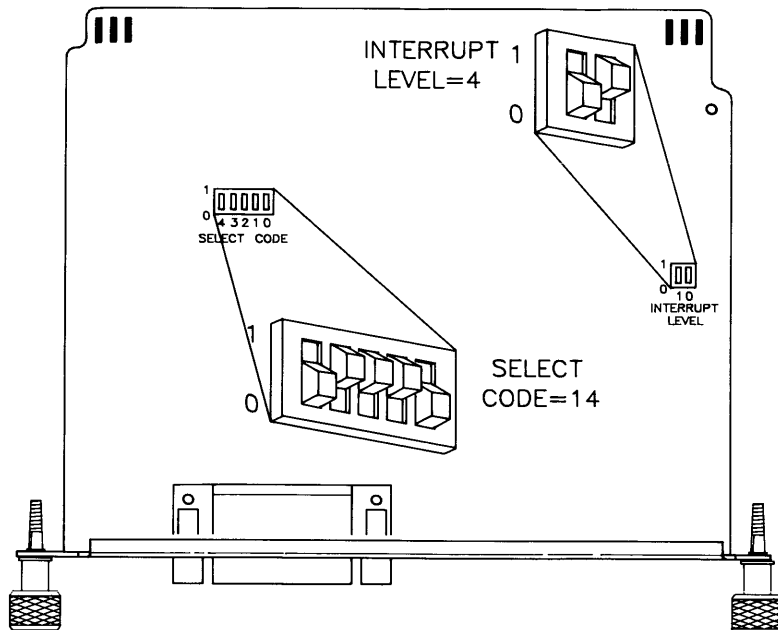

Figure 5-8. HP 98625A Disc Interface switches.

---

### NOTE

The HP 98625A Disc Interface cannot be installed in the HP 9888A bus expander. It can be installed in the HP 98568A Backplane Expander, however.

---

#### 1. Play It Safe.

- a. Turn your computer off and unplug the power cord.
- b. Remove the Disc Interface from its envelope, being careful to handle the card only by its edges and metal end plate. The card may be easily damaged by electrostatic discharge (static zap).
- c. Place the card on the envelope.

## 2. Set the Select Code.

---

### CAN YOU SKIP THIS STEP?

If this is the first (or only) HP 98625 (A or B) Disc Interface you are installing, you can skip to step 3. The select code is preset to 14 and need not be changed.

**However**, if you have the HP 98265A SCSI card, it also is preset to Select Code 14, so you will need to continue with step 2 to change the select code on your HP 98625A Interface.

---

- a. Find the set of five select code switches by referring to Figure 5-8.
- b. Set these switches to one of the four select codes given below, unless you have used them elsewhere. Refer to the installation note that came with the interface if you need additional switch settings.

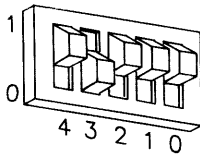

**Select Code 23**

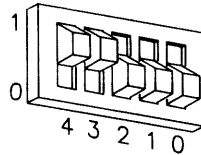

**Select Code 24**

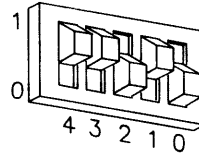

**Select Code 26**

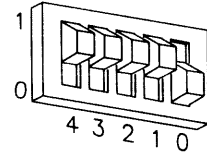

**Select Code 30**

### 3. Set the Interrupt Level.

---

#### CAN YOU SKIP THIS STEP?

If you are not using HP-UX, you can skip to step 4. The interrupt level is preset to 6 and need not be changed. If you will be using HP-UX continue with step 3.

---

- a. Find the Interrupt Level switches by referring to Figure 5-8.
- b. If using HP-UX, set these switches to interrupt level 4 as shown in Figure 5-8. To get interrupt level 4, set the left switch to **0** and the right switch to **1**. **Do not set any other interface to interrupt level 4.**

### 4. Insert the Interface.

- a. Remove the *painted* cover plates from the back of your computer until you find an empty *even-numbered* slot. (Slots are numbered from the top down, so the top-most slot is number 1, the next slot down is number 2, etc.) **Do not** remove the silver cover plates from the bottom of a Series 300 computer.
- b. Insert the Disc Interface, component side up, into the empty even-numbered slot. Tighten the thumb screws on the metal end plate until the end plate is flush with the back of the computer.
- c. If you changed the select code of the Disc Interface in step 2, find this number in the set of select code labels supplied with the interface. Affix this label to the metal end plate.
- d. If you have other interface or accessory cards to install, leave the cover plates off; otherwise, replace them.

### 5. Record the Select Code.

- a. Make a note that select code 14 (or the alternate select code you chose in step 2) has been used and is no longer available. Use the “Select Code Record” form on the Step 5 tab for this purpose.

## Verification Test

1. Plug in the power cord and turn your computer on. If you have systems on-line that the computer can boot, press the space bar a few times to suspend the automatic booting process.
2. Check the list of components displayed on the left-hand side of the screen:
  - If the message, **HP98625**, appears in the list, you have correctly installed the Disc Interface.
  - If the message above does not appear, repeat the installation procedure, making sure there are no select code conflicts and that the card is firmly seated in an even-numbered slot. If the message still does not appear, call your HP Service Representative for assistance.

---

## The Next Step

You have now installed the Disc Interface.

The following “Worksheet Entries” contain information needed to use the Disc Interface with various language/operating systems. Refer to the table for the system you’ll be using.

Copy this information to a worksheet (worksheets are found at the end of Step 1) or simply remember to refer here when you need it. **If you changed the select code in step 2-b, write in your new select code instead of 14.**

When finished, you’ll be ready to install your next peripheral or interface.

---

## BASIC System Worksheet Entry

Interface Name	Select Code	Driver Name
HP 98625A	14	FHPIB

---

## Pascal Workstation Worksheet Entry

Interface Name	Select Code	Module Name
HP 98625A	14	DISC_INTF & DMA

---

### NOTE

Before you can access the HP 98625A Disc Interface from the Pascal Workstation, you must make a few modifications. See the Special Configurations chapter of the *Pascal Workstation System* manual for details.

---

---

## HP-UX System Worksheet Entry

Interface Name	Select Code
HP 98625A	14

---

# Installing the HP 98625B Disc Interface

---

## NOTE

If you have an HP 98625A Disc Interface, see the previous section.

---

### Description

The HP 98625B Disc Interface provides a high-speed HP-IB interface to Command Set 80 (CS/80) discs. The Disc Interface is capable of handling up to four discs on one interface card. A DMA Controller card is required for the Disc Interface to achieve optimum performance.

### Support

You can use the HP 98625B Disc Interface with any HP Series 200 computer with boot ROM 3.0 or later, or with any Series 300 computer with boot ROM Rev A. or later.

Operating/language system support is as follows:

- **BASIC:** supported on revision 2.1 or later with Series 200 computers; supported on revision 4.0 or later with Series 300 computers.
- **Pascal Workstation:** supported on revision 2.0 or later with Series 200 computers; supported on revision 3.1 or later with Series 300 computers.
- **HP-UX Operating System:** supported on revision 2.0 or later with Series 200 computers; supported on revision 5.0 or later with Series 300 computers.

## HP 98625B Disc Interface Installation Procedure

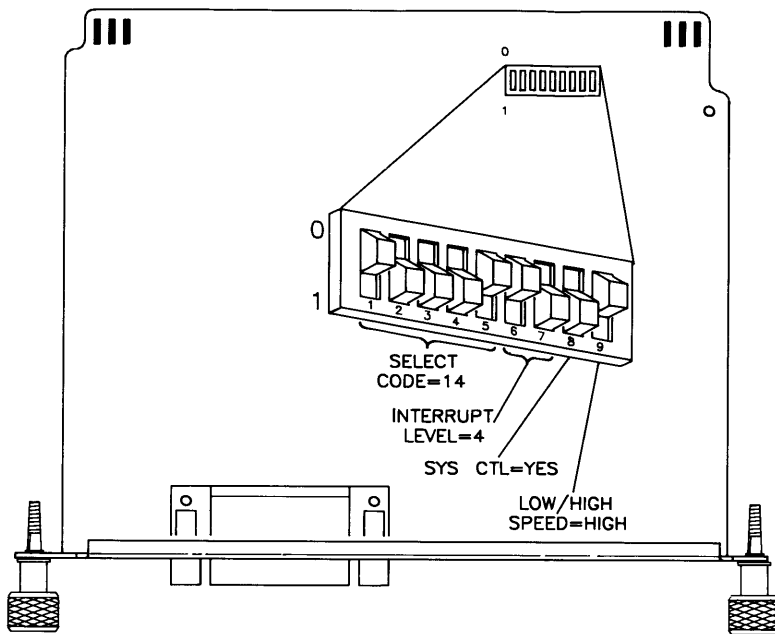

**Figure 5-9. HP 98625B Disc Interface switches.**

---

### NOTE

The HP 98625B Disc Interface cannot be installed in the HP 9888A bus expander. It can be installed in the HP 98568A Backplane Expander, however.

---

#### 1. Play It Safe.

- a. Turn your computer off and unplug the power cord.
- b. Remove the Disc Interface from its envelope, being careful to handle the card only by its edges and metal end plate. The card may be easily damaged by electrostatic discharge (static zap).
- c. Place the card on the envelope.



## 2. Set the Select Code.

---

### CAN YOU SKIP THIS STEP?

If this is the first (or only) HP 98625 (A or B) Disc Interface you are installing, you can skip to step 3. The select code is preset to 14 and need not be changed.

**However**, if you have the HP 98265A SCSI card, it also is preset to Select Code 14, so you will need to continue with step 2 to change the select code on your HP 98625B Interface.

---

- a. Find the set of nine switches by referring to Figure 5-9. Switches 1 through 5 in this group determine the select code.
- b. Set these switches to one of the four select codes given below, unless you have used them elsewhere. Refer to the installation note that came with the interface if you need additional switch settings.

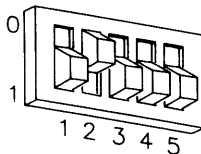

**Select Code 23**

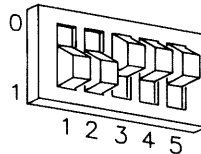

**Select Code 24**

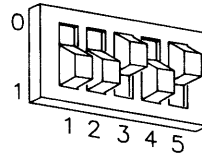

**Select Code 26**

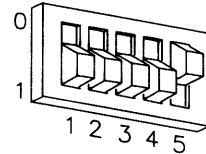

**Select Code 30**

### 3. Set the Interrupt Level.

---

#### CAN YOU SKIP THIS STEP?

If you are not using HP-UX, you can skip to step 4. The interrupt level is preset to 6 and need not be changed. If you will be using HP-UX continue with step 3.

---

- a. Find the set of nine switches by referring to Figure 5-9. Switches 6 and 7 in this group determine the interrupt level.
- b. If using HP-UX, set these switches to interrupt level 4 as shown in Figure 5-9. To get interrupt level 4, set the left switch to **0** and the right switch to **1**. **Do not set any other interface (except for the HP 98629A SRM Interface) to interrupt level 4.**

### 4. Set the System Controller Switch.

---

#### CAN YOU SKIP THIS STEP?

Unless you intend to connect two computers together with this interface, you can skip to step 5. The interface is configured to be system controller and need not be changed.

---

- a. Find the set of nine switches by referring to Figure 5-9. Switch 8 in this group determines the system controller setting.
- b. If connecting two computers together via HP-IB, only one of them may be set to system controller. To change this interface to non-system controller, move the system controller switch shown in Figure 5-9 to the 0 position (the opposite of that shown).

**Note:** If you will be connecting a disc drive, printer, plotter or other peripheral to this interface, *and* you will be using an HP Series 200/300 operating system, **do not** set this switch to non-system controller.

## 5. Set the Low/High Speed Switch.

---

### CAN YOU SKIP THIS STEP?

---

The Low/High Speed switch is preset to **0**, “high speed,” as shown in Figure 5-9. This setting is appropriate for most applications. If you want to change this setting, continue with step 5; otherwise skip to step 6.

---

- a. Find the set of nine switches by referring to Figure 5-9. Switch 9 in this group is the Low/High Speed switch.
- b. Set this switch as follows:
  - To set this switch to “low speed,” set switch 9 to **1**, which is opposite of that shown in Figure 5-9.
  - To set this switch to “high speed,” set switch 9 to **0** as shown in Figure 5-9.

## 6. Insert the Interface.

- a. Remove the *painted* cover plates from the back of your computer until you find an empty *even-numbered* slot. (Slots are numbered from the top down, so the top-most slot is number 1, the next slot down is number 2, etc.) **Do not** remove the silver cover plates from the bottom of a Series 300 computer.
- b. Insert the Disc Interface, component side up, into the empty even-numbered slot. Tighten the thumb screws on the metal end plate until the end plate is flush with the back of the computer.
- c. If you changed the select code of the Disc Interface in step 2, find this number in the set of select code labels supplied with the interface. Affix this label to the metal end plate.
- d. If you have other interface or accessory cards to install, leave the cover plates off; otherwise, replace them.

## 7. Record the Select Code.

- a. Make a note that select code 14 (or the alternate select code you chose in step 2) has been used and is no longer available. Use the “Select Code Record” form on the Step 5 tab for this purpose.

## Verification Test

1. Plug in the power cord and turn your computer on. If you have systems on-line that the computer can boot, press the space bar a few times to suspend the automatic booting process.
2. Check the list of components displayed on the left-hand side of the screen:
  - If the message, **HP98625**, appears in the list, you have correctly installed the Disc Interface.
  - If the message above does not appear, repeat the installation procedure, making sure there are no select code conflicts and that the card is firmly seated in an even-numbered slot. If the message still does not appear, call your HP Service Representative for assistance.

---

## The Next Step

You have now installed the Disc Interface.

The following “Worksheet Entries” contain information needed to use the Disc Interface with various language/operating systems. Refer to the table for the system you’ll be using.

Copy this information to a worksheet (worksheets are found at the end of Step 1) or simply remember to refer here when you need it. **If you changed the select code in step 2-b, write in your new select code instead of 14.**

When finished, you’ll be ready to install your next peripheral or interface.

---

## BASIC System Worksheet Entry

Interface Name	Select Code	Driver Name
HP 98625B	14	FHPIB

---

## Pascal Workstation Worksheet Entry

Interface Name	Select Code	Module Name
HP 98625B	14	DISC_INTF & DMA

---

### NOTE

Before you can access the HP 98625B Disc Interface from the Pascal Workstation, you must make a few modifications. See the Special Configurations chapter of the *Pascal Workstation System* manual for details.

---

---

## HP-UX System Worksheet Entry

Interface Name	Select Code
HP 98625B	14

---

# Installing the HP 98626A RS-232C Interface

## Description

The HP 98626A RS-232C Interface is connected to a terminal, modem, serial peripheral, or computer and supports the RS-232C standard. One interface is required for each device, and each interface must be set to a unique select code.

## Support

You can use the HP 98626A RS-232C Interface with any HP Series 200 or Series 300 computer.

Operating/language system support is as follows:

- **BASIC:** supported on revision 1.0 or later with Series 200 computers; supported on revision 4.0 or later with Series 300 computers.
- **Pascal Workstation:** supported on revision 1.0 or later with Series 200 computers; supported on revision 3.1 or later with Series 300 computers.
- **HP-UX Operating System:** supported on revision 2.0 or later with Series 200 computers; supported on revision 5.0 or later with Series 300 computers.

# HP 98626A RS-232C Interface Installation Procedure

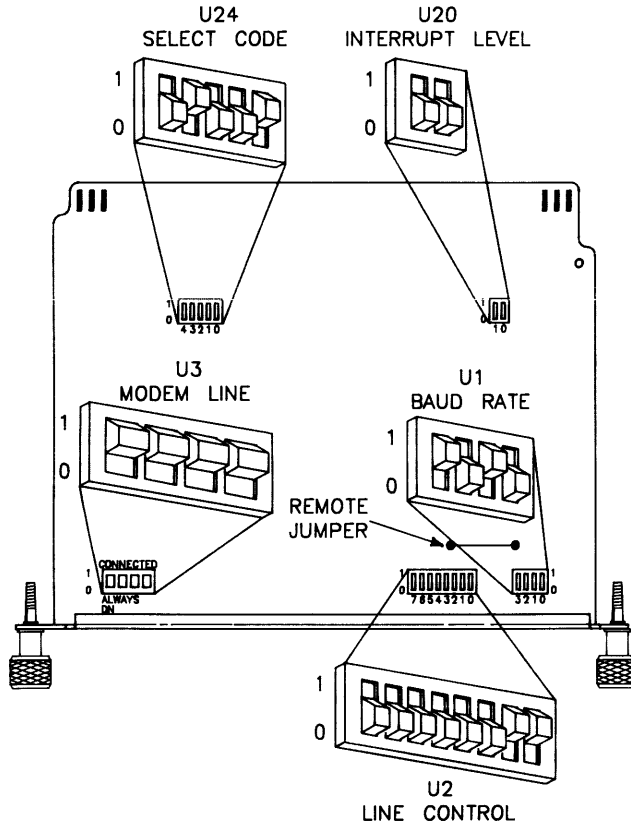

Figure 5-10. HP 98626A RS-232C Serial Interface Switches

## 1. Play It Safe.

- a. Turn your computer off and unplug the power cord.
- b. Remove the RS-232C Interface from its envelope, being careful to handle the card only by its edges and metal end plate. The card may be easily damaged by electrostatic discharge (static zap).
- c. Place the card on the envelope.

## 2. Set the Select Code.

---

### CAN YOU SKIP THIS STEP?

If you have a Series 200 Model 220, 226, 236 or 237 computer, and you have not already installed an HP 98626A or HP 98644A interface, then you can skip to step 3. The select code is preset to 9 and need not be changed.

---

- a. Find the set of five select code switches, labeled U24, by referring to Figure 5-10.
- b. Set these switches to one of the five select codes given below, unless you have used them elsewhere (check the Select Code Record on the Step 5 tab to see which ones you have used). Refer to the installation note that came with the interface if you need additional switch settings.

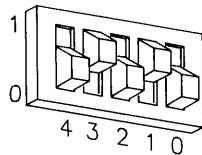

**Select Code 10**

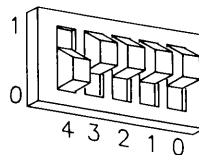

**Select Code 15**

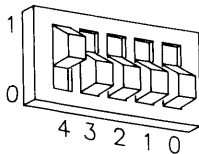

**Select Code 16**

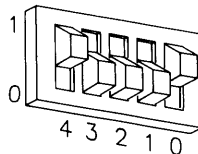

**Select Code 17**

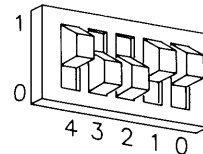

**Select Code 19**



### 3. Set the Interrupt Level.

---

#### CAN YOU SKIP THIS STEP?

If you will be using the BASIC Language System or the Pascal Workstation with this interface, you can skip to step 4. The interrupt level is preset to 3 and need not be changed. If you will be using HP-UX, continue with step 3.

---

- a. Find the two interrupt level switches, labeled U20, by referring to Figure 5-10.
- b. If using HP-UX, set these switches to interrupt level 5 by setting switch 0 to **0** and switch 1 to **1**. The switches will look like this:

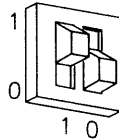

### 4. Set the Baud Rate.

- a. Find the four baud rate switches, labeled U1, by referring to Figure 5-10.
- b. Set the baud rate switches as follows:
  - If connecting an HP 2601A printer, an HP 39800/01A bar code reader, or an HP 92205A/C *Hayes Smartmodem 1200* to this interface, set the baud rate switches to 1200. To get 1200 baud, set switch 3 to **1**, and set switches 2, 1 and 0 to **0**. The switches will look like this:

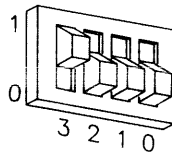

- If connecting a terminal or an HP 2686 *Laserjet* printer to this interface, set the baud rate switches to 9600. To get 9600 baud, set switches 3, 2 and 1 to **1**, and set switch 0 to **0**. The switches will look like this:

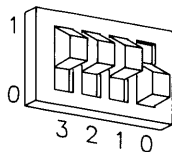

- If connecting any other device to this interface, set the baud rate switches to match the baud rate of the device. See the installation manual that came with the interface for all baud rate settings.

#### 5. Set the Character Length.

---

##### CAN YOU SKIP THIS STEP?

The interface's character length is preset to 8 bits/character. Unless you are certain that this is inappropriate for your application, leave the character length setting alone and skip to step 6.

---

- a. The character length switches, numbers 0 and 1 on the group labeled U2, are preset to 8 bits/character, which is appropriate for most applications. If you know you need to change the character length, refer to the manual that came with the interface for additional settings.

#### 6. Set the Number of Stop Bits.

---

##### CAN YOU SKIP THIS STEP?

The interface is preset to 1 stop bit. Unless you are certain that 1 stop bit is inappropriate for your application, leave the stop bit setting alone and skip to step 7.

---

- a. The stop bits switch, number 2 on the group labeled U2, is preset to 1 stop bit, which is appropriate for most applications. If you know you need to change the number of stop bits to 2, change this switch to its alternate setting.

## 7. Set the Parity Enable Switch.

- a. Find the group of Line Control switches, labeled U2 on the interface, by referring to Figure 5-10. Switch 3 in this group is the parity enable switch.
- b. Set the parity enable switch as follows:
  - If connecting a terminal, an HP 2601A printer or an HP 2686 *Laserjet* printer to this interface, set this switch to “parity disabled.” To disable parity, set switch 3 to **0** like this:

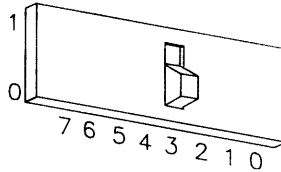

- If connecting an HP 39800/01A bar code reader or an HP 92205A/C *Hayes Smartmodem 1200* to this interface, set this switch to “parity enabled.” To enable parity, set switch 3 to **1** like this:

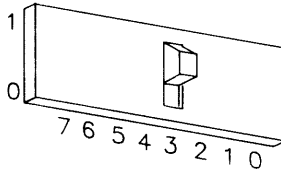

- If connecting any other device to this interface, set this switch to match that of the connected device.

## 8. Set the Parity Type.

- a. Find the Line Control switches, labeled U2 on the interface, by referring to Figure 5-10. Switches 4 and 5 in this group determine the parity type.
- b. Set the parity type switches as follows:
  - If connecting a terminal, HP 2601A printer or HP 2686 *Laserjet* printer to this interface, the parity type does not matter since parity was disabled in step 7. Skip to step 9.
  - If connecting an HP 39800/01A bar code reader, set this switch to “parity is 0.” To set parity to 0, set both switches 4 and 5 to **1** like this:

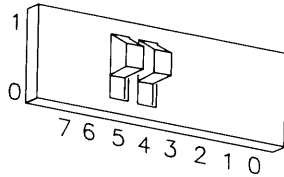

- If connecting an HP 92205A/C *Hayes Smartmodem 1200* to this interface, set the parity type to match the setting on the computer or terminal you are communicating with. See the installation manual that came with the interface for details.

## 9. Set the Handshake Type (Pascal Workstation and HP-UX only).

- a. Find the Line Control switches, labeled U2 on the interface, by referring to Figure 5-10. Switches 6 and 7 in this group determine the handshake type.
- b. Set the handshake type switches to XON/XOFF. To get XON/XOFF, set switch 6 to **1**, and set switch 7 to **0** like this:

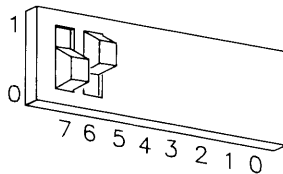

## 10. Set the Modem Line Switches.

- a. Find the Modem Line switches, labeled U3 on the interface, by referring to Figure 5-10.
- b. Set these switches as follows:
  - If connecting a modem, HP 2601A printer, HP 2686A *Laserjet* printer, or *uucp* to this interface, set these switches to the “Connected” position as shown in Figure 5-10.
  - If connecting a terminal or bar code reader, set these switches to the “Always on” position, which is *opposite* that shown in Figure 5-10.

## 11. Set the Remote Jumper.

---

### CAN YOU SKIP THIS STEP?

Unless you want to connect your system console terminal to this interface, you can skip to step 12.

---

- a. Find the remote keyboard jumper by referring to Figure 5-10.
- b. If you are connecting a terminal to this interface and would like the terminal to be the system console, remove the remote keyboard jumper. Otherwise, leave the jumper intact.

## 12. Insert the Interface.

- a. Remove the *painted* cover plates from the back of your computer until you find an empty *even-numbered* slot. (Slots are numbered from the top down, so the top-most slot is number 1, the next slot down is number 2, etc.) **Do not** remove the silver cover plates from the bottom of a Series 300 computer.
- b. Insert the RS-232C Interface, component side up, into the empty even-numbered slot. Tighten the thumb screws on the metal end plate until the end plate is flush with the back of the computer.
- c. If you changed the select code of the RS-232C Interface in step 2, find this number in the set of select code labels supplied with the interface. Affix this label to the metal end plate.
- d. If you have other interface or accessory cards to install, leave the cover plates off; otherwise, replace them.

### 13. Record the Select Code.

- a. Make a note that select code 9 (or the alternate select code you chose in step 2) has been used and is no longer available. Use the “Select Code Record” form on the Step 5 tab for this purpose.

## Verification Test

1. Plug in the power cord and turn your computer on. If you have systems on-line that the computer can boot, press the space bar a few times to suspend the automatic booting process.
2. Check the list of components displayed on the left-hand side of the screen:
  - If the message, **HP98626**, appears in the list, you have correctly installed the HP 98626A RS-232C Interface.
  - If the message above does not appear, repeat the installation procedure, making sure there are no select code conflicts and that the card is firmly seated in an even-numbered slot. If the message still does not appear, call your HP Service Representative for assistance.

---

## The Next Step

You have now installed the RS-232C Interface.

The following “Worksheet Entries” contain information needed to use the RS-232C Interface with various language/operating systems. Refer to the table for the system you’ll be using.

Copy this information to a worksheet (worksheets are found at the end of Step 1) or simply remember to refer here when you need it. **If you changed the select code in step 2-b, write in your new select code instead of 9.**

When finished, you’ll be ready to install your next peripheral or interface.

---

## BASIC System Worksheet Entry

Interface Name	Select Code	Driver Name
HP 98626A	9	SERIAL

---

## Pascal Workstation Worksheet Entry

Interface Name	Select Code	Module Name
HP 98626A	9	RS232

---

### NOTE

Before you can access the HP 98626A RS-232C Interface from the Pascal Workstation, you must make a few modifications. See the Special Configurations chapter of the *Pascal Workstation System* manual for details.

---

---

## HP-UX System Worksheet Entry

Interface Name	Select Code
HP 98626A	9

---

# Installing the HP 98627A Color Output Interface

## Description

The HP 98627A Color Output Interface allows you to connect an external color monitor to your computer.

## Support

You can use the HP 98627A Color Output Interface with any HP Series 200 computer with boot ROM 3.0 or later, or with any Series 300 computer with boot ROM Rev. A or later.

Operating/language system support is as follows:

- **BASIC:** supported on revision 2.1 or later with Series 200 computers; supported on revision 4.0 or later with Series 300 computers.
- **Pascal Workstation:** supported on revision 2.0 or later with Series 200 computers; supported on revision 3.1 or later with Series 300 computers.
- **HP-UX Operating System:** supported on revision 2.0 or later with Series 200 computers; supported on revision 5.1 or later with Series 300 computers.



## Color Output Interface Installation Procedure

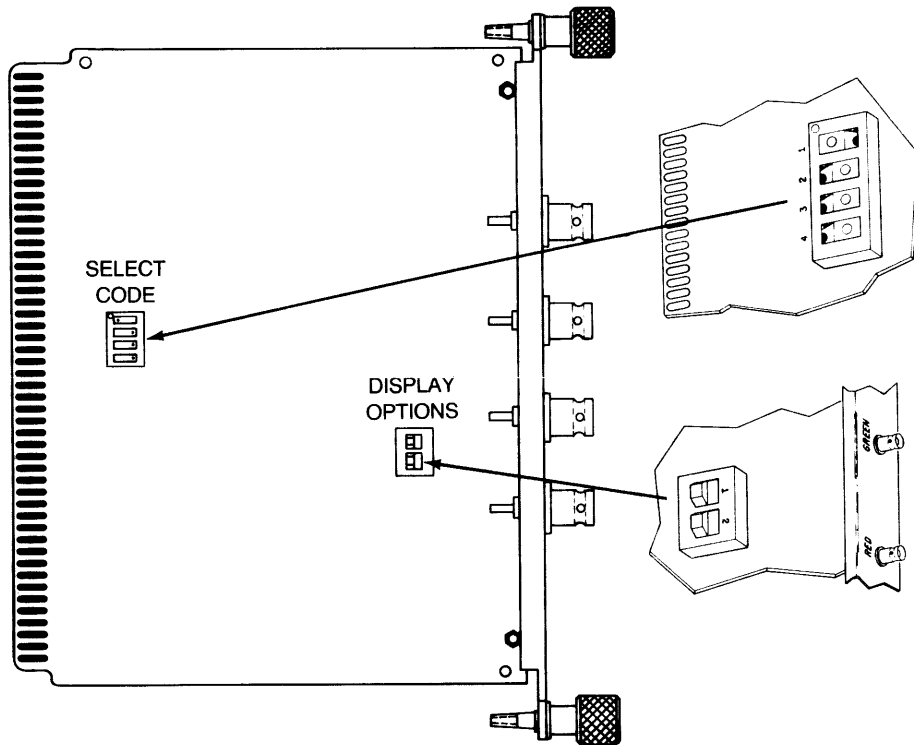

Figure 5-11. HP 98627A Color Video Output Interface Switches

### 1. Play It Safe.

- a. Turn your computer off and unplug the power cord.
- b. Remove the Color Output Interface from its envelope, being careful to handle the card only by its edges and metal end plate. The card may be easily damaged by electrostatic discharge (static zap).
- c. Place the card on the envelope.

## 2. Set the Select Code.

---

### CAN YOU SKIP THIS STEP?

If this is the first (or only) HP 98627A Color Output Interface you are installing, you can skip to step 3. The Color Output Interface is preset to use select codes 28 and 29, and need not be changed.

**Possible Conflict:** The Multiprogrammer Interface is preset to select code 29 and will conflict with the default select code setting of the Color Output Interface. If you have both of these interfaces, change the select code of the Multiprogrammer Interface.

---

- a. Find the set of four select code switches by referring to Figure 5-11.
- b. The select code switches must be set to an even select code and the next odd select code must not be used by another interface. Find an even select code that meets this stipulation.
- c. Refer to the manual that came with the interface to set the select code switches to the value you've chosen.

## 3. Set Option Switch 1.

---

### CAN YOU SKIP THIS STEP?

If you intend to connect an HP 13279B Color Monitor to this interface, you can skip to step 4. Option switch 1 is preset for a combined green and sync signal and need not be changed.

---

- a. Set option switch 1 as follows:
  - If connecting an HP 13279B Color Monitor to this interface, set option switch 1 for combined green and sync signal as shown in Figure 5-11.
  - If connecting some other monitor, set option switch 1 *opposite* of that shown in Figure 5-11 if the monitor provides for a separate sync signal; otherwise set the interface to a combined green and sync signal by setting option switch 1 as shown in Figure 5-11.

#### 4. Set option switch 2.

---

### CAN YOU SKIP THIS STEP?

---

If you intend to connect an HP 13279B Color Monitor to this interface, you can skip to step 5. Option switch 2 is preset to a 24.8 kHz horizontal scan and need not be changed.

---

#### a. Set option switch 2 as follows:

- If connecting an HP 13279B Color Monitor to this interface, set option switch 2 to 24.8 kHz horizontal scan as shown in Figure 5-11.
- If connecting some other monitor, set option switch 2 *opposite* of that shown in Figure 5-11 if the monitor has a 15.75 kHz horizontal scan; set option switch 2 as shown in Figure 5-11 if the monitor has a 24.8 kHz scan.

#### 5. Insert the Interface.

- a. Remove the *painted* cover plates from the back of your computer until you find an empty *even-numbered* slot. (Slots are numbered from the top down, so the top-most slot is number 1, the next slot down is number 2, etc.) **Do not** remove the silver cover plates from the bottom of a Series 300 computer.
- b. Insert the Color Output Interface, component side up, into the empty even-numbered slot. Tighten the thumb screws on the metal end plate until the end plate is flush with the back of the computer.
- c. If you changed the select code of the Color Output Interface in step 2, find this number in the set of select code labels supplied with the interface. Affix this label to the metal end plate.
- d. If you have other interface or accessory cards to install, leave the cover plates off; otherwise, replace them.

#### 6. Record the Select Code.

- a. Make a note that select codes 28 and 29 (or the alternate select codes you chose in step 2) have been used and are no longer available. Use the "Select Code Record" form on the Step 5 tab for this purpose.

## Verification Test

1. Plug in the power cord and turn your computer on. If you have systems on-line that the computer can boot, press the space bar a few times to suspend the automatic booting process.
2. Check the list of components displayed on the left-hand side of the screen:
  - If the message, **HP98627**, appears in the list, you have correctly installed the Color Output Interface.
  - If the message above does not appear, repeat the installation procedure, making sure there are no select code conflicts and that the card is firmly seated in an even-numbered slot. If the message still does not appear, call your HP Service Representative for assistance.

---

## The Next Step

You have now installed the Color Output Interface.

The following “Worksheet Entries” contain information needed to use the Color Output Interface with various language/operating systems. Refer to the table for the system you’ll be using.

Copy this information to a worksheet (worksheets are found at the end of Step 1) or simply remember to refer here when you need it. **If you changed the select code in step 2-b, write in your new select code instead of 28.**

When finished, you’ll be ready to install your next peripheral or interface.

---

## BASIC System Worksheet Entry

Interface Name	Select Code	Driver Name
HP 98627A	28	-

### BASIC Notes

- To send graphics to the monitor connected to the Color Output Interface at select code 28 (the default setting), execute:

```
PLOTTER IS 28, "98627A"
```

---

## Pascal Workstation Worksheet Entry

Interface Name	Select Code	Module Name
HP 98627A	28	-

---

## HP-UX System Worksheet Entry

Interface Name	Select Code
HP 98627A	28

### HP-UX Notes

- The character mode major number for the Color Output Interface is 12.
- A typical *mknod* for a Color Output Interface at select code 28 (the default) is:

```
# mknod /dev/graphics c 12 0x1c0200
```

The `1c` represents select code 28 (1c is hexadecimal for 28).

---

# Installing the HP 98628A Datacomm Interface

## Description

The HP 98628A Datacomm Interface connects to a serial peripheral, terminal, modem or computer and supports the RS-232C datacomm standard. One interface is required for each terminal, and each interface must be set to a unique select code.

## Support

You can use the HP 98628A Datacomm Interface with any HP Series 200 computer with boot ROM 3.0 or later, or with any Series 300 computer with boot ROM Rev. A or later.

Operating/language system support is as follows:

- **BASIC:** supported on revision 2.0 or later with Series 200 computers; supported on revision 4.0 or later with Series 300 computers.
- **Pascal Workstation:** supported on revision 2.0 or later with Series 200 computers; supported on revision 3.1 or later with Series 300 computers.
- **HP-UX Operating System:** supported on revision 2.0 or later with Series 200 computers; supported on revision 5.0 or later with Series 300 computers.

# Datacomm Interface Installation Procedure

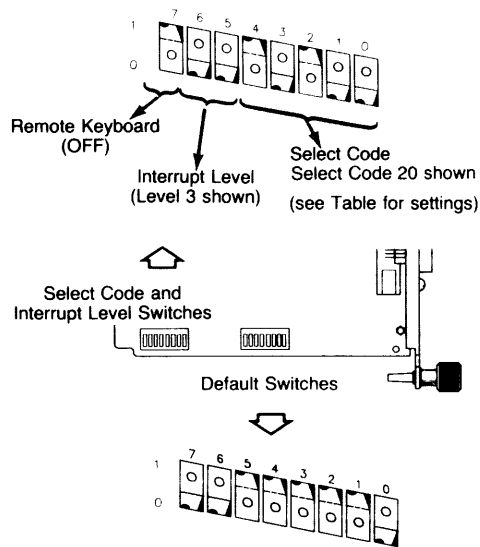

**Figure 5-12. HP 98628A Datacomm Interface Switches**

## 1. Play It Safe.

- a. Turn your computer off and unplug the power cord.
- b. Remove the Datacomm Interface from its envelope, being careful to handle the card only by its edges and metal end plate. The card may be easily damaged by electrostatic discharge (static zap).
- c. Place the card on the envelope.

## 2. Set the Select Code.

---

### CAN YOU SKIP THIS STEP?

If this is the *first* (or only) Datacomm Interface you are installing, you can skip to step 3. The select code is preset to 20 and need not be changed.

---

- a. Find the set of select code and interrupt level switches by referring to Figure 5-12. Switches 0 thru 4 in this group determine the select code.
- b. Set these switches to one of the five select codes given below, unless you have used them elsewhere (check the Select Code Record on the Step 5 tab to see which ones you have used). Refer to the installation note that came with the interface if you need additional switch settings.

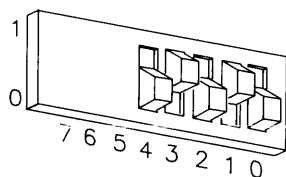

**Select Code 10**

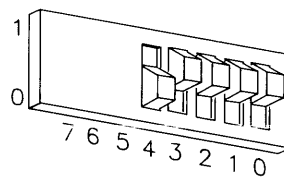

**Select Code 15**

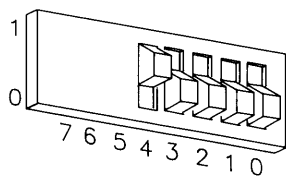

**Select Code 16**

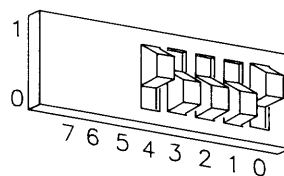

**Select Code 17**

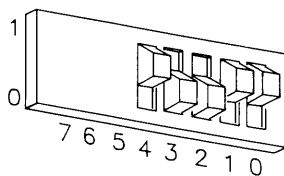

**Select Code 19**



### 3. Set the Interrupt Level.

---

#### CAN YOU SKIP THIS STEP?

The interface is preset to interrupt level 3. Unless you are certain that interrupt level 3 is inappropriate for your application, leave the interrupt level setting alone and skip to step 4.

---

- a. Find the set of select code and interrupt level switches by referring to Figure 5-12. Switches 5 and 6 in this group determine the interrupt level.
- b. If you need to change the interrupt level, set the switches according to the following table:

Interrupt Level	Switches	
	6	5
3	0	0
4	0	1
5	1	0
6	1	1

### 4. Set the Remote Switch.

---

#### CAN YOU SKIP THIS STEP?

If you are **not** connecting your system console to this interface, you can skip to step 5. The Remote switch is preset to “OFF,” which does **not** configure the interface to be the system console.

---

- a. Find the set of select code and interrupt level switches by referring to Figure 5-12. Switch 7 in this group is the Remote switch.

b. Set the Remote switch as follows:

- If you are connecting a terminal to this interface and want the terminal to be the system console, set this switch to **0** (remote), which is *opposite* that shown in Figure 5-12. Be aware that the boot ROM will not recognize this terminal as the system console, even though HP-UX will. No boot ROM messages will appear on the associated terminal; therefore, do not use the HP 98628A as a system console until after HP-UX is installed.
- If you are connecting a terminal to this interface but **do not** want the terminal to be the system console, set this switch to **1** (OFF) as shown in Figure 5-12.

#### 5. Set the Protocol Switch.

---

#### CAN YOU SKIP THIS STEP?

If you will **not** be using this interface for networking with an HP 1000 computer (via the HP DSN/Data Link protocol), then you can skip to step 6. The protocol switch is preset for the Async protocol and need not be changed for most applications.

---

- a. Find the Default switch group by referring to Figure 5-12. Switch 0 in this group is the protocol switch.
- b. Set the protocol switch as follows:
- If you want the Async protocol, used with most connections, set switch 0 to **0** as shown in Figure 5-12.
  - If you want the HP DSN/Data Link protocol, used in networking with an HP 1000 host computer, set switch 0 to **1**, which is *opposite* that shown in Figure 5-12.

## 6. Set the Baud Rate.

- a. Find the Default switch group by referring to Figure 5-12. Switches 1 thru 3 in this group determine the baud rate.
- b. Set the baud rate switches as follows:
  - If connecting an HP 2601A printer or an HP 92205A/C *Hayes Smart-modem 1200* to this interface, set the baud rate switches to 1200. To get 1200 baud, set switch 3 to **1**, and set switches 2 and 1 to **0**. The switches will look like this:

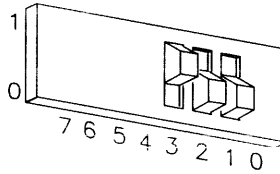

- If connecting a terminal or an HP 2686 *Laserjet* printer to this interface, set the baud rate switches to 9600. To get 9600 baud, set switches 3, 2 and 1 to **1** as shown in Figure 5-12.
- If connecting an HP 39800/01A Bar Code Reader to this interface, set the baud rate switches to 2400. To get 2400 baud, set switches 3 and 1 to **1**, and set switch 2 to **0**. The switches will look like this:

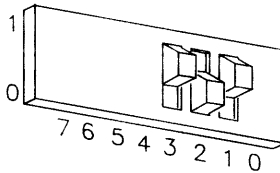

- If connecting any other device to this interface, set the baud rate switches to match the baud rate of the device. See the installation manual that came with the interface for all baud rate settings.

## 7. Set the Hardware Handshake.

- a. Find the Default switch group by referring to Figure 5-12. Switches 4 and 5 in this group determine the hardware handshake.
- b. Set the hardware handshake switches as follows:
  - If connecting an HP 92205A/C Hayes *Smartmodem 1200*, an HP 2334A X.25 Cluster Controller, or *uucp*, set switch 5 to **0** and set switch 4 to **1**. This sets up a full duplex modem connection. The switches will look like this:

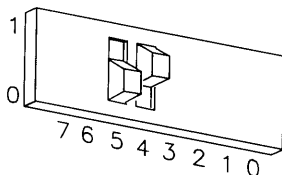

- If connecting an HP 2686 *Laserjet* printer or an HP 2601A printer, set both switches 5 and 4 to **1** as shown in Figure 5-12. This sets up a non-modem connection with the handshake on.
- If connecting a terminal or HP 39800/01A bar code reader, set both switches 4 and 5 to **0**, which is *opposite* that shown in Figure 5-12. This sets up a non-modem connection with the handshake off.

## 8. Set the Parity Type/Character Length.

- a. Find the Default switch group by referring to Figure 5-12. Switches 6 and 7 in this group determine the parity type/character length.
- b. Set the parity type/character length switches as follows:
  - If connecting an HP 92205A/C Hayes *Smartmodem 1200*, set the parity type/character length switches to match the device you are communicating with. Refer to the manual that came with the interface for a list of settings.
  - If connecting a terminal, an HP 2686 *Laserjet* printer, an HP 2601A printer, or an HP 39800/01A bar code reader, set both switches 6 and 7 to **0** as shown in Figure 5-12. This sets up 8 bits/character and no parity.

## 9. Insert the Interface.

- a. Remove the *painted* cover plates from the back of your computer until you find an empty *even-numbered* slot. (Slots are numbered from the top down, so the top-most slot is number 1, the next slot down is number 2, etc.) **Do not** remove the silver cover plates from the bottom of a Series 300 computer.
- b. Insert the Datacomm Interface, component side up, into the empty even-numbered slot. Tighten the thumb screws on the metal end plate until the end plate is flush with the back of the computer.
- c. If you changed the select code of the Datacomm Interface in step 2, find this number in the set of select code labels supplied with the interface. Affix this label to the metal end plate.
- d. If you have other interface or accessory cards to install, leave the cover plates off; otherwise, replace them.

## 10. Record the Select Code.

- a. Make a note that select code 20 (or the alternate select code you chose in step 2) has been used and is no longer available. Use the "Select Code Record" form on the Step 5 tab for this purpose.

## Verification Test

1. Plug in the power cord and turn your computer on. If you have systems on-line that the computer can boot, press the space bar a few times to suspend the automatic booting process.
2. Check the list of components displayed on the left-hand side of the screen:
  - If the message, **HP98628**, appears in the list, you have correctly installed the Datacomm Interface.
  - If the message above does not appear, repeat the installation procedure, making sure there are no select code conflicts and that the card is firmly seated in an even-numbered slot. If the message still does not appear, call your HP Service Representative for assistance.

---

## The Next Step

You have now installed the Datacomm Interface.

The following “Worksheet Entries” contain information needed to use the Datacomm Interface with various language/operating systems. Refer to the table for the system you’ll be using.

Copy this information to a worksheet (worksheets are found at the end of Step 1) or simply remember to refer here when you need it. **If you changed the select code in step 2-b, write in your new select code instead of 20.**

When finished, you’ll be ready to install your next peripheral or interface.

---

## BASIC System Worksheet Entry

Interface Name	Select Code	Driver Name
HP 98628A	20	DCOMM

---

## Pascal Workstation Worksheet Entry

Interface Name	Select Code	Module Name
HP 98628A	20	DATA_COMM

---

### NOTE

Before you can access the HP 98628A Datacomm Interface from the Pascal Workstation, you must make a few modifications. See the Special Configurations chapter of the *Pascal Workstation System* manual for details.

---

---

## HP-UX System Worksheet Entry

Interface Name	Select Code
HP 98628A	20

---

# Installing the HP 98629A and HP 50961A SRM Interfaces

## Description

The HP 98629A Shared Resource Management (SRM) Interface and the HP 50961A SRM Coax Interface provide both protocol management and electrical levels for communication between the computer and the Shared Resource Management (SRM) system. The SRM system allows the computer to share common discs, printers and plotters.

## Support

You can use the HP 98629A SRM Interface and the HP 50961A SRM Coax Interface with any HP Series 200 computer with boot ROM 3.0 or later, or with any Series 300 computer with Boot ROM Rev. A or later.

Operating/language system support is as follows:

- **BASIC:** supported on revision 2.1 or later with Series 200 computers; supported on revision 4.0 or later with Series 300 computers.
- **Pascal Workstation:** supported on revision 2.0 or later with Series 200 computers; supported on revision 3.1 or later with Series 300 computers.
- **HP-UX Operating System:** supported on revision 2.1 or later with Series 200 computers (requires HP 98693A SRM Utilities software); supported on revision 5.0 or later with Series 300 computers.

## SRM Interface Installation Procedure

SRM installation is not documented here. Refer to the manuals that came with your SRM system. However, do perform the verification test and fill out your worksheet after installing the interface. Also record the SRM Interface select code (21) in the "Select Code Record" form on the Step 5 tab.

---

### NOTE

Both the SRM and LAN interfaces are preset to select code 21. If you have both SRM and LAN interfaces, change the setting of the LAN Interface to an unused value.

---



## Verification Test

1. Plug in the power cord and turn your computer on. If you have systems on-line that the computer can boot, press the space bar a few times to suspend the automatic booting process.
2. Check the list of components displayed on the left-hand side of the screen:
  - If the message, **HP98629**, appears in the list, you have correctly installed the SRM Interface.
  - If the message above does not appear, repeat the installation procedure, making sure there are no select code conflicts and that the card is firmly seated in an even-numbered slot. If the message still does not appear, call your HP Service Representative for assistance.

---

## The Next Step

You have now installed the SRM Interface.

The following “Worksheet Entries” contain information needed to use the SRM Interface with various language/operating systems. Refer to the table for the system you’ll be using.

Copy this information to a worksheet (worksheets are found at the end of Step 1) or simply remember to refer here when you need it. **If you changed the select code, write in your new select code instead of 21.**

When finished, you’ll be ready to install your next peripheral or interface.

---

## BASIC System Worksheet Entry

Interface Name	Select Code	Driver Name
HP 98629A	21	DCOMM & SRM

---

## Pascal Workstation Worksheet Entry

Interface Name	Select Code	Module Name
HP 98629A	21	DATA_COMM & SRM

---

### NOTE

Before you can access the HP 98629A or HP 50961A SRM Interface from the Pascal Workstation, you must make a few modifications. See the "Special Configurations" chapter of the *Pascal Workstation System* manual for details.

---

---

## HP-UX System Worksheet Entry

Interface Name	Select Code
HP 98629A	21

### HP-UX Notes

- The SRM Interface is shipped with the same select code (21) as the HP 98643A LAN Interface. If you have both of these interfaces, change the LAN Interface to a different select code. Refer to the manual that came with the LAN Interface for a list of settings.
- A typical *mknod* for an SRM Interface set to select code 21 and node address 0 is:

```
# mknod /dev/srm 13 c 0x000000
```

---

# Installing the HP 98633A Multiprogrammer Interface

## Description

The HP 98633A Multiprogrammer Interface lets you connect the HP 6944A Multiprogrammer.

## Support

You can use the HP 98633A Multiprogrammer Interface with any HP Series 200 computer with boot ROM 3.0 or later. Support of this interface on Series 300 computers was under investigation at the time of printing.

Operating/language system support is as follows:

- **BASIC:** supported on revision 2.1 or later with Series 200 computers.
- **Pascal Workstation:** not supported.
- **HP-UX Operating System:** not supported.

## Multiprogrammer Interface Installation Procedure

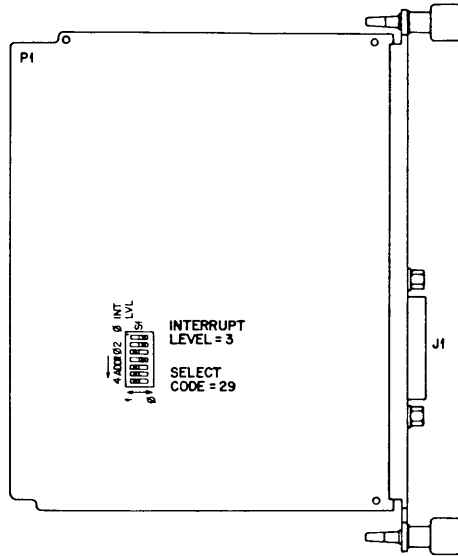

**Figure 5-13. Multiprogrammer Interface Switches**

### 1. Play It Safe.

- a. Turn your computer off and unplug the power cord.
- b. Remove the Multiprogrammer Interface from its envelope, being careful to handle the card only by its edges and metal end plate. The card may be easily damaged by electrostatic discharge (static zap).
- c. Place the card on the envelope.

## 2. Set the Select Code.

---

### CAN YOU SKIP THIS STEP?

If this is the first (or only) HP 98633A Multiprogrammer Interface you are installing, *and* you do not also have an HP 98627A Color Output Interface, then you can skip to step 3. The Multiprogrammer Interface is preset to select code 29 and need not be changed.

---

- a. Find the set of select code and interrupt level switches by referring to Figure 5-13. The lower-most five switches determine the select code.
- b. Set these switches to one of the four select codes given below, unless you have used them elsewhere (check the Select Code Record on the Step 5 tab to see which ones you have used). Refer to the installation note that came with the interface if you need additional switch settings.

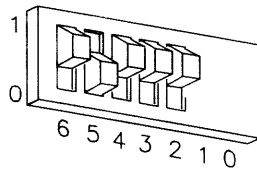

**Select Code 23**

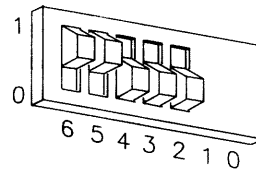

**Select Code 24**

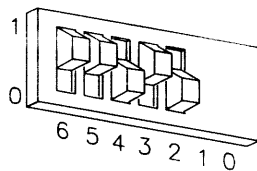

**Select Code 26**

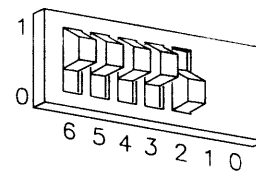

**Select Code 30**

### 3. Set the Interrupt Level.

---

#### CAN YOU SKIP THIS STEP?

---

The interface is preset to interrupt level 3. Unless you are certain that interrupt level 3 is inappropriate for your application, leave the interrupt level setting alone and skip to step 4.

---

- a. Find the set of select code and interrupt level switches by referring to Figure 5-13. The two top-most switches in this group determine the interrupt level.
- b. If you need to change the interrupt level, refer to the manual that came with the interface for a list of settings.

### 4. Insert the Interface.

- a. Remove the *painted* cover plates from the back of your computer until you find an empty *even-numbered* slot. (Slots are numbered from the top down, so the top-most slot is number 1, the next slot down is number 2, etc.) **Do not** remove the silver cover plates from the bottom of a Series 300 computer.
- b. Insert the Multiprogrammer Interface, component side up, into the empty even-numbered slot. Tighten the thumb screws on the metal end plate until the end plate is flush with the back of the computer.
- c. If you changed the select code of the Multiprogrammer Interface in step 2, find this number in the set of select code labels supplied with the interface. Affix this label to the metal end plate.
- d. If you have other interface or accessory cards to install, leave the cover plates off; otherwise, replace them.

### 5. Record the Select Code.

- a. Make a note that select code 29 (or the alternate select code you chose in step 2) has been used and is no longer available. Use the "Select Code Record" form on the Step 5 tab for this purpose.

## Verification Test

1. Plug in the power cord and turn your computer on. If you have systems on-line that the computer can boot, press the space bar a few times to suspend the automatic booting process.
2. Check the list of components displayed on the left-hand side of the screen:
  - If you have boot ROM 4.0 or later, the message, **HP98633**, should appear in the list. If it does, you have correctly installed the Multiprogrammer Interface. If no message appears, repeat the installation procedure, making sure there are no select code conflicts and that the card is firmly seated in an even-numbered slot. If the message still does not appear, call your HP Service Representative for assistance.
  - If you have boot ROM 3.0, no message will appear, as boot ROM 3.0 does not identify the Multiprogrammer Interface. Assume installation is correct.

---

## The Next Step

You have now installed the Multiprogrammer Interface.

The following “Worksheet Entry” contains information needed to use the Multiprogrammer Interface with BASIC.

Copy this information to a worksheet (worksheets are found at the end of Step 1) or simply remember to refer here when you need it. **If you changed the select code in step 2-b, write in your new select code instead of 29.**

When finished, you’ll be ready to install your next peripheral or interface.

---

## BASIC System Worksheet Entry

Interface Name	Select Code	Driver Name
HP 98633A	29	-

---

# Installing the HP 98640A Analog Input Card

## Description

The HP 98640A Analog Input card provides screw terminations for seven analog input voltages and one reference voltage. The terminations are located on the exterior of the end plate.

## Support

You can use the HP 98640A Analog Input Card with any HP Series 200 computer with boot ROM 3.0 or later. Support of this card on Series 300 computers was under investigation at the time of printing.

Operating/language system support is as follows:

- **BASIC:** supported on revision 2.1 or later with Series 200 computers.
- **Pascal Workstation:** support was under investigation at the time of printing.
- **HP-UX Operating System:** not supported.

## Analog Input Card Installation Procedure

1. **Play It Safe.**
  - a. Turn your computer off and unplug the power cord.
  - b. Remove the Analog Input Interface from its envelope, being careful to handle the card only by its edges and extractor levers. The card may be easily damaged by electrostatic discharge (static zap).
  - c. Place the card on the envelope.



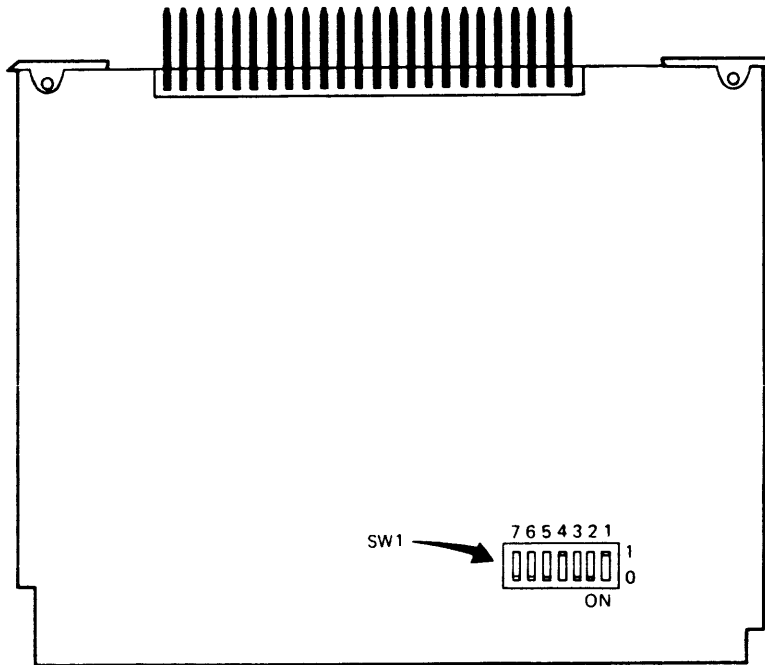

**Figure 5-14. Analog Input Card Switches**

**2. Set the Select Code and Interrupt Level.**

- a. The Analog Input Interface is preset to a select code of 18 and an interrupt level of 3. These settings are appropriate for most applications and need not be changed. If you already have an interface set to select code 18, or if you would like to change the interrupt level, refer to the manual that came with the interface for a list of settings.

**3. Insert the Interface.**

- a. Remove the *painted* cover plates from the back of your computer until you find an empty *even-numbered* slot. (Slots are numbered from the top down, so the top-most slot is number 1, the next slot down is number 2, etc.) **Do not** remove the silver cover plates from the bottom of a Series 300 computer.
- b. Insert the Analog Input Interface, component side up, into the empty even-numbered slot.

- c. Connect the analog inputs to the external screw terminations (see Figure 5-15).

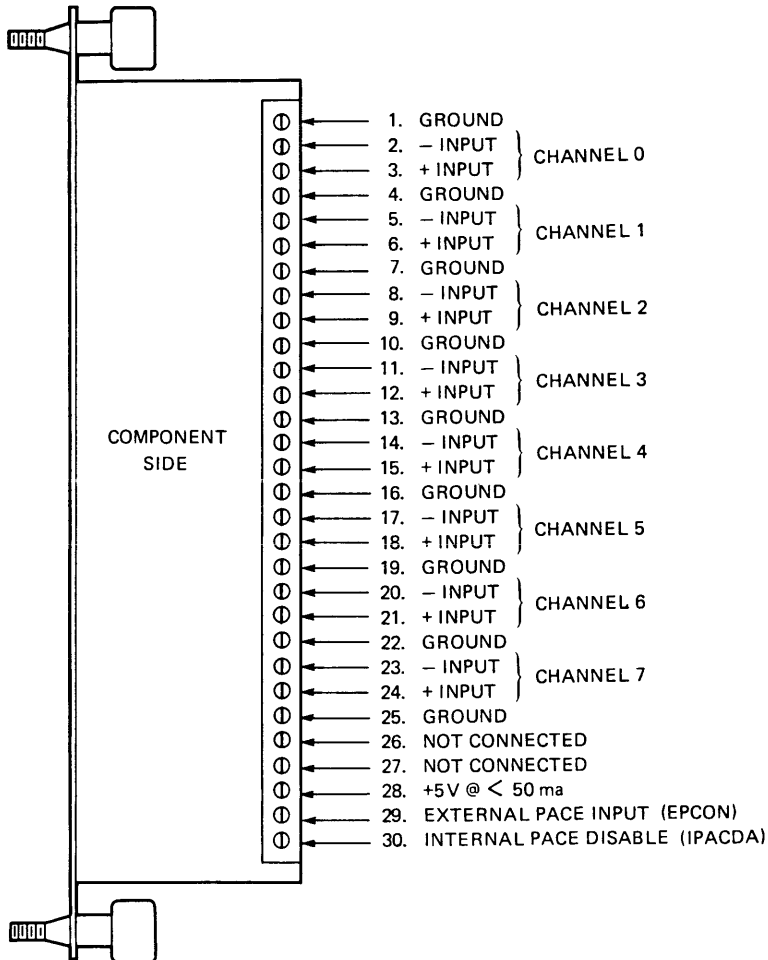

**Figure 5-15. Wire termination inputs.**

- d. If you changed the select code of the Analog Input Interface in step 2, find this number in the set of select code labels supplied with the interface. Affix this label to the metal end plate.

- e. If you have other interface or accessory cards to install, leave the cover plates off; otherwise, replace them.

#### 4. Record the Select Code.

- a. Make a note that select code 18 (or the alternate select code you chose in step 2) has been used and is no longer available. Use the “Select Code Record” form on the Step 5 tab for this purpose.

### Verification Test

1. Plug in the power cord and turn your computer on. If you have systems on-line that the computer can boot, press the space bar a few times to suspend the automatic booting process.
2. Check the list of components displayed on the left-hand side of the screen:
  - If you have boot ROM 4.0 or later, the message, **HP98640**, should appear in the list. If it does, you have correctly installed the Analog Input Interface. If no message appears, repeat the installation procedure, making sure there are no select code conflicts and that the card is firmly seated in an even-numbered slot. If the message still does not appear, call your HP Service Representative for assistance.
  - If you have boot ROM 3.0, no message will appear, as boot ROM 3.0 does not identify the Analog Input Interface. Assume installation is correct.

---

## The Next Step

You have now installed the Analog Input Interface.

The following “Worksheet Entry” contains information needed to use the Analog Input Interface with BASIC.

Copy this information to a worksheet (worksheets are found at the end of Step 1) or simply remember to refer here when you need it. **If you changed the select code in step 2-b, write in your new select code instead of 18.**

When finished, you’ll be ready to install your next peripheral or interface.

---

## BASIC System Worksheet Entry

Interface Name	Select Code	Driver Name
HP 98640A	18	-

---

# Installing the HP 98642A 4-Channel Multiplexer Interface

## Description

The HP 98642A 4-Channel Multiplexer Interface has three direct-connect ports and one port with full modem control. The buffering of this interface makes it suitable for nearly all applications, including graphics terminals.

## Support

You can use the HP 98642A 4-channel Multiplexer Interface with any HP Series 300 computer. Support for Series 200 computers is planned but was not yet authorized at the time of printing.

Operating/language system support is as follows:

- **BASIC:** not supported.
- **Pascal Workstation:** not supported.
- **HP-UX Operating System:** supported on revision 5.0 or later with Series 300 computers.

# HP 98642A 4-Channel Multiplexer Interface Installation Procedure

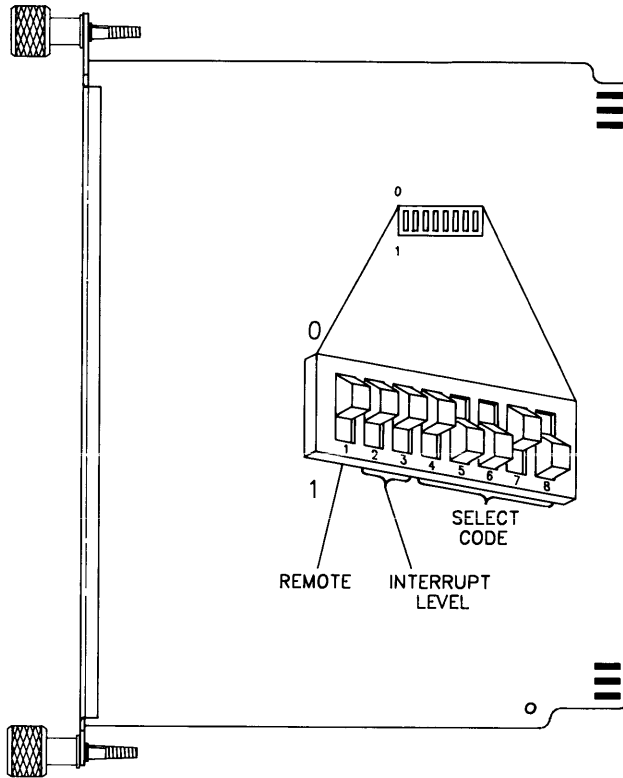

Figure 5-16. HP 98642A 4-Channel Multiplexer Interface switches.

## 1. Play It Safe.

- a. Turn your computer off and unplug the power cord.
- b. Remove the 4-Channel Multiplexer Interface from its envelope, being careful to handle the card only by its edges and metal end plate. The card may be easily damaged by electrostatic discharge (static zap).
- c. Place the card on the envelope.

## 2. Set the Select Code.

---

### CAN YOU SKIP THIS STEP?

If this is the *first* (or only) 4-Channel Multiplexer Interface you are installing, you can skip to step 3. The select code is preset to 13 and need not be changed.

---

- Find the group of eight switches on the interface by referring to Figure 5-16. Switches 4 thru 8 in this group determine the select code.
- Set these switches to one of the five select codes given below, unless you have used them elsewhere (check the Select Code Record on the Step 5 tab to see which ones you have used). Refer to the installation note that came with the interface if you need additional switch settings.

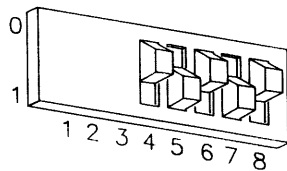

**Select Code 10**

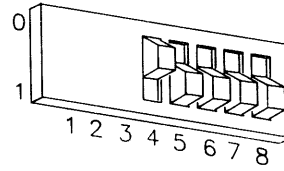

**Select Code 15**

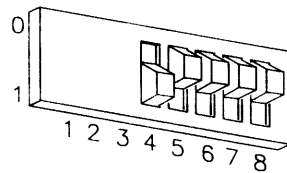

**Select Code 16**

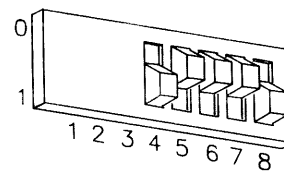

**Select Code 17**

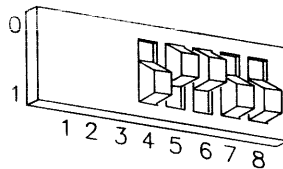

**Select Code 19**

### 3. Set the Interrupt Level.

---

#### CAN YOU SKIP THIS STEP?

The interface is preset to interrupt level 3. Unless you are certain that interrupt level 3 is inappropriate for your application, leave the interrupt level setting alone and skip to step 4.

---

- a. Find the group of eight switches on the interface by referring to Figure 5-16. Switches 2 and 3 in this group determine the interrupt level.
- b. Set the interrupt level to the desired value by referring to the following table:

Interrupt Level	Switches	
	2	3
3	0	0
4	0	1
5	1	0
6	1	1

### 4. Set the Remote Switch.

---

#### CAN YOU SKIP THIS STEP?

If you are **not** connecting your system console to port 1 of this interface, skip to step 5. The Remote switch is preset to “local,” which does **not** configure port 1 to be the system console.

---

- a. Find the group of eight switches on the interface by referring to Figure 5-16. Switch 1 in this group is the Remote switch.



b. Set the Remote switch as follows:

- If you are connecting a terminal to port 1 of this interface and want the terminal on port 1 to be the system console, set this switch to **1** (remote), which is *opposite* that shown in Figure 5-16. Be aware that the boot ROM will not recognize this terminal as the system console, even though HP-UX will. No boot ROM messages will appear on the associated terminal; therefore, do not use the HP 98642A as a system console until after HP-UX is installed.
- If you are connecting a terminal to port 1 of this interface but **do not** want the terminal on port 1 to be the system console, set this switch to **0** (local) as shown in Figure 5-16.

#### 5. **Insert the Interface.**

- a. Remove the *painted* cover plates from the back of your computer until you find an empty *even-numbered* slot. (Slots are numbered from the top down, so the top-most slot is number 1, the next slot down is number 2, etc.) **Do not** remove the silver cover plates from the bottom of a Series 300 computer.
- b. Insert the 4-Channel Multiplexer Interface, component side up, into the empty even-numbered slot. Tighten the thumb screws on the metal end plate until the end plate is flush with the back of the computer.
- c. If you changed the select code of the 4-Channel Multiplexer Interface in step 2, find this number in the set of select code labels supplied with the interface. Affix this label to the metal end plate.
- d. If you have other interface or accessory cards to install, leave the cover plates off; otherwise, replace them.

#### 6. **Record the Select Code.**

- a. Make a note that select code 13 (or the alternate select code you chose in step 2) has been used and is no longer available. Use the "Select Code Record" form on the Step 5 tab for this purpose.

## Verification Test

1. Plug in the power cord and turn your computer on. If you have systems on-line that the computer can boot, press the space bar a few times to suspend the automatic booting process.
2. Check the list of components displayed on the left-hand side of the screen:
  - If the message, **HP98642**, appears in the list, you have correctly installed the HP 98642A 4-Channel Multiplexer Interface.
  - If the message does not appear, repeat the installation procedure, making sure there are no select code conflicts and that the card is firmly seated in an even-numbered slot. If the message still does not appear, call your HP Service Representative for assistance.

---

## The Next Step

You have now installed the HP 98642A 4-Channel Multiplexer Interface.

The following “Worksheet Entry” contains information needed to use the 4-Channel Multiplexer Interface with HP-UX.

Copy this information to a worksheet (worksheets are found at the end of Step 1) or simply remember to refer here when you need it. **If you changed the select code in step 2-b, write in your new select code instead of 13.**

When finished, you’ll be ready to install your next peripheral or interface.

---

## HP-UX System Worksheet Entry

Interface Name	Select Code
HP 98642A	13

---

# Installing the HP 98643A Local Area Network (LAN) Interface

## Description

The HP 98643A Local Area Network (LAN) Interface is used to connect a computer to a local area network.

## Support

You can use the HP 98643A LAN Interface with any HP Series 300 computer. Support for Series 200 computers, excluding the Model 216, is planned but had not yet been authorized at the time of printing.

Operating/language system support is as follows:

- **BASIC:** not supported.
- **Pascal Workstation:** not supported.
- **HP-UX Operating System:** supported on revision 5.0 or later with Series 300 computers.

## HP 98643A LAN Interface Installation Procedure

LAN installation is not documented here. Refer to the manuals that came with your LAN system. However, do perform the verification test and fill out your worksheet after installing the interface. Also record the LAN Interface select code on the “Select Code Record” form on the Step 5 tab.

---

### NOTE

Both the LAN and SRM interfaces are preset to select code 21. If you have both LAN and SRM interfaces, change the select code of the LAN Interface to an unused value.

---

## Verification Test

1. Plug in the power cord and turn your computer on. If you have systems on-line that the computer can boot, press the space bar a few times to suspend the automatic booting process.
2. Check the list of components displayed on the left-hand side of the screen:
  - If the message, **HP98643**, appears in the list, you have correctly installed the HP 98643A LAN Interface.
  - If the message does not appear, repeat the installation procedure, making sure there are no select code conflicts and that the card is firmly seated in an even-numbered slot. If the message still does not appear, call your HP Service Representative for assistance.

---

## The Next Step

You have now installed the HP 98643A LAN Interface.

The following “Worksheet Entry” contains information needed to use the LAN Interface with HP-UX.

Copy this information to a worksheet (worksheets are found at the end of Step 1) or simply remember to refer here when you need it. **If you changed the select code, write in your new select code instead of 21.**

When finished, you'll be ready to install your next peripheral or interface.

---

## HP-UX System Worksheet Entry

Interface Name	Select Code
HP 98643A	21

### HP-UX Notes

- The character-mode major number for an IEEE-802 network is 18. The character-mode major number for an Ethernet<sup>TM</sup> is 19.
- A typical *mknod* for a LAN Interface at select code 21 on an IEEE-802 (major number 18) Local Area Network is:

```
# mknod /dev/lan 18 c 0x150000
```

The 15 in the minor number represents the select code (15 is the hexadecimal value for 21).

---

<sup>1</sup> Ethernet<sup>TM</sup> is a trademark of the Xerox Corporation.

---

# Installing the HP 98644A RS-232C Serial Interface

## Description

The HP 98644A RS-232C Serial Interface is connects a terminal, modem, serial peripheral, or computer that supports the RS-232C standard. One interface is required for each device, and each interface must be set to a unique select code.

## Support

You can use the HP 98644A RS-232C Serial Interface with any HP Series 200 computer with boot ROM 3.0 or later, or with any Series 300 computer with boot ROM Rev. A or later.

Operating/language system support is as follows:

- **BASIC:** supported on revision 3.0 or later with Series 200 computers; supported on revision 4.0 or later with Series 300 computers. Earlier revisions can access this interface if it is set to emulate the HP 98626A RS-232C Interface (see installation instructions below).
- **Pascal Workstation:** Supported on revision 3.0 or later with Series 200 computers; supported on revision 3.1 or later with Series 300 computers. Earlier revisions can access this interface if it is set to emulate the HP 98626A RS-232C Interface (see installation instructions below).
- **HP-UX Operating System:** supported on revision 2.1 or later with Series 200 computers; supported on revision 5.0 or later with Series 300 computers.

## HP 98644A RS-232C Serial Interface Installation Procedure

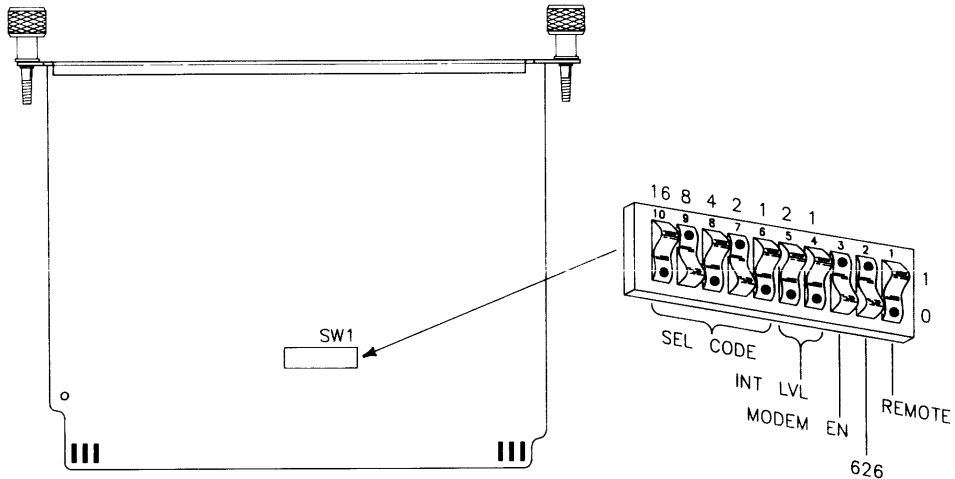

**Figure 5-17. HP 98644A RS-232C Serial Interface switches.**

### 1. Play It Safe.

- a. Turn your computer off and unplug the power cord.
- b. Remove the RS-232 Serial Interface from its envelope, being careful to handle the card only by its edges and metal end plate. The card may be easily damaged by electrostatic discharge (static zap).
- c. Place the card on the envelope.

## 2. Set the Select Code.

---

### CAN YOU SKIP THIS STEP?

If you have a Series 200 Model 220, 226, 236 or 237 computer, *and* you have not already installed an HP 98626A or HP 98644A interface, then you can skip to step 3. The select code is preset to 9 and need not be changed.

---

- a. Find the group of switches labeled SW1 by referring to Figure 5-17. Switches 6 thru 10 in this group determine the select code.
- b. Set these switches to one of the five select codes given below, unless you have used them elsewhere (check the Select Code Record on the Step 5 tab to see which ones you have used). Refer to the installation note that came with the interface if you need additional switch settings.

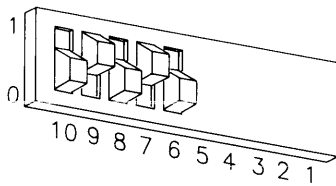

**Select Code 10**

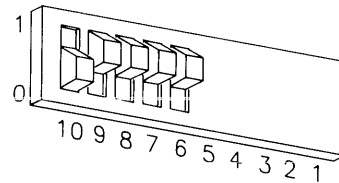

**Select Code 15**

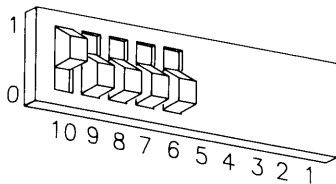

**Select Code 16**

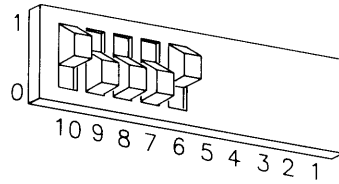

**Select Code 17**

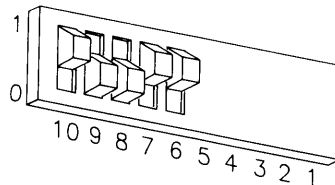

**Select Code 19**



### 3. Set the Interrupt Level.

---

#### CAN YOU SKIP THIS STEP?

---

The interface is preset to interrupt level 3. Unless you are certain that interrupt level 3 is inappropriate for your application, leave the interrupt level setting alone and skip to step 4.

---

- a. Find the group of switches labeled SW1 by referring to Figure 5-17. Switches 4 and 5 in this group determine the interrupt level.
- b. Set the interrupt level to the desired value by referring to the following table:

Interrupt Level	Switches	
	5	4
3	0	0
4	0	1
5	1	0
6	1	1

### 4. Set the MODEM ENable Switch.

- a. Find the group of switches labeled SW1 by referring to Figure 5-17. Switch 3 in this group is the MODEM ENable switch.
- b. Set the MODEM ENable switch as follows:
  - If you intend to connect an HP 2601A printer, an HP 2686A *Laserjet* printer, an HP 92205A/C Hayes *Smartmodem*, or a *uucp*, set this switch to **1** as shown in Figure 5-17.
  - If you intend to connect a terminal or the HP 39800/01A bar code reader, set this switch to **0**, which is *opposite* that shown in Figure 5-17.

### 5. Set the 626 Switch.

- a. Find the group of switches labeled SW1 by referring to Figure 5-17. Switch 2 in this group is the 626 switch.
- b. Set the 626 switch to **1** as shown in Figure 5-17.

## 6. Set the REMOTE Switch.

- a. Find the group of switches labeled SW1 by referring to Figure 5-17. Switch 1 in this group is the Remote switch.
- b. Set the Remote switch as follows:
  - If you are connecting a terminal to this interface and want this terminal to be the system console, set this switch to **1**, which is *opposite* that shown in Figure 5-17.
  - If you are connecting a terminal to this interface but **do not** want this terminal to be the system console, or if you are connecting any other device, set this switch to **0** as shown in Figure 5-17.

## 7. Insert the Interface.

- a. Remove the *painted* cover plates from the back of your computer until you find an empty *even-numbered* slot. (Slots are numbered from the top down, so the top-most slot is number 1, the next slot down is number 2, etc.) **Do not** remove the silver cover plates from the bottom of a Series 300 computer.
- b. Insert the RS-232 Serial Interface, component side up, into the empty even-numbered slot. Tighten the thumb screws on the metal end plate until the end plate is flush with the back of the computer.
- c. If you changed the select code of the RS-232 Serial Interface in step 2, find this number in the set of select code labels supplied with the interface. Affix this label to the metal end plate.
- d. If you have other interface or accessory cards to install, leave the cover plates off; otherwise, replace them.

## 8. Record the Select Code.

- a. Make a note that select code 9 (or the alternate select code you chose in step 2) has been used and is no longer available. Use the “Select Code Record” form on the Step 5 tab for this purpose.

## Verification Test

1. Plug in the power cord and turn your computer on. If you have systems on-line that the computer can boot, press the space bar a few times to suspend the automatic booting process.
2. Check the list of components displayed on the left-hand side of the screen:
  - If you have boot ROM 4.0 or later, the message, **HP98644**, should appear in the list. If it does, you have correctly installed the HP 98644A RS-232 Serial Interface. If no message appears, repeat the installation procedure, making sure there are no select code conflicts and that the card is firmly seated in an even-numbered slot. If the message still does not appear, call your HP Service Representative for assistance.
  - If you have boot ROM 3.0, no message will appear, as boot ROM 3.0 does not identify the HP 98644A RS-232 Serial Interface. Assume installation is correct.

---

## The Next Step

You have now installed the HP 98644A RS-232 Serial Interface.

The following “Worksheet Entries” contain information needed to use the RS-232 Serial Interface with various language/operating systems. Refer to the table for the system you’ll be using.

Copy this information to a worksheet (worksheets are found at the end of Step 1) or simply remember to refer here when you need it. **If you changed the select code in step 2-b, write in your new select code instead of 9.**

When finished, you’ll be ready to install your next peripheral or interface.

---

## BASIC System Worksheet Entry

Interface Name	Select Code	Driver Name
HP 98644A	9	SERIAL

---

## Pascal Workstation Worksheet Entry

Interface Name	Select Code	Module Name
HP 98644A	9	RS232

---

### NOTE

Before you can access the HP 98644A RS-232 Serial Interface from the Pascal Workstation, you must make a few modifications. See the Special Configurations chapter of the *Pascal Workstation System* manual for details.

---

---

## HP-UX System Worksheet Entry

Interface Name	Select Code
HP 98644A	9

---

# Installing the HP 98695A IBM 3270 Coax Interface

## Description

The HP 98695A 3270 Coax Interface allows you to connect your computer to an IBM 3270 controller over a type A coax. It contains a high speed microprocessor and an 8K byte buffer. It can respond to the 3270 controller as either a 3278 or 3279 Display Station.

## Support

You can use the HP 98695A 3270 Coax Interface with the following Series 200 computers:

- Model 216 computers with display enhancements. See your *Model 216 Installation Guide* for details.
- Model 220 computers with display enhancements.
- Model 236 computers with boot ROM 3.0 or later.

You can use this interface with any Series 300 computer.

Operating/language system support is as follows:

- **BASIC:** supported on revision 2.0 or later with Series 200 computers; supported on revision 4.0 or later with Series 300 computers. Low-level user I/O programming is required.
- **Pascal Workstation:** supported on revision 1.0 or later with Series 200 computers; supported on revision 3.1 or later with Series 300 computers. Low-level user I/O programming is required.
- **HP-UX Operating System:** not supported.

## HP 98695A 3270 Coax Interface Installation Procedure

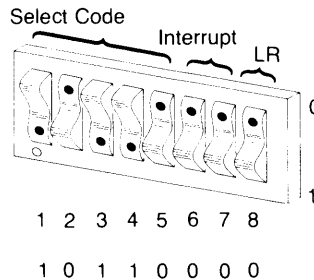

**Figure 5-18. HP 98695A 3270 Coax Interface Switches**

### 1. Play It Safe.

- Turn your computer off and unplug the power cord.
- Remove the 3270 Coax Interface from its envelope, being careful to handle the card only by its edges and metal end plate. The card may be easily damaged by electrostatic discharge (static zap).
- Place the card on the envelope.

### 2. Set the Select Code.

---

#### CAN YOU SKIP THIS STEP?

If this is the *first* (or only) 3270 Coax Interface you are installing, you can skip to step 3. The select code is preset to 22 and need not be changed.

---

- Find the group of switches shown in Figure 5-18. Switches 1 thru 5 in this group determine the select code.

- b. Set these switches to one of the four select codes given below, unless you have used them elsewhere (check the Select Code Record on the Step 5 tab to see which ones you have used). Refer to the installation note that came with the interface if you need additional switch settings.

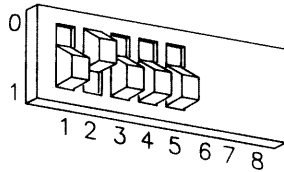

**Select Code 23**

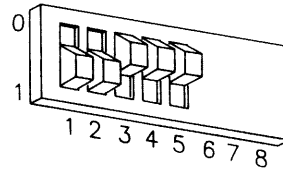

**Select Code 24**

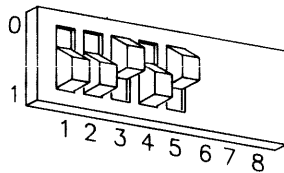

**Select Code 26**

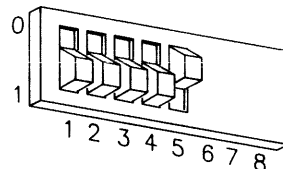

**Select Code 30**

### 3. Set the Remaining Switches.

- a. The remaining switches should all be set to 0 as shown in Figure 5-18.

### 4. Insert the Interface.

- a. Remove the *painted* cover plates from the back of your computer until you find an empty *even-numbered* slot. (Slots are numbered from the top down, so the top-most slot is number 1, the next slot down is number 2, etc.) **Do not** remove the silver cover plates from the bottom of a Series 300 computer.
- b. Insert the 3270 Coax Interface, component side up, into the empty even-numbered slot. Tighten the thumb screws on the metal end plate until the end plate is flush with the back of the computer.
- c. If you changed the select code of the 3270 Coax Interface in step 2, find this number in the set of select code labels supplied with the interface. Affix this label to the metal end plate.
- d. Connect the coaxial cable from the interface to the 3274/6 controller.
- e. If you have other interface or accessory cards to install, leave the cover plates off; otherwise, replace them.

## 5. Record the Select Code.

- a. Make a note that select code 22 (or the alternate select code you chose in step 2) has been used and is no longer available. Use the “Select Code Record” form on the Step 5 tab for this purpose.

## Verification Test

1. Plug in the power cord and turn your computer on. If you have systems on-line that the computer can boot, press the space bar a few times to suspend the automatic booting process.
2. Check the list of components displayed on the left-hand side of the screen:
  - If the message, **HP98695**, appears in the list, you have correctly installed the 3270 Coax Interface.
  - If the message above does not appear, repeat the installation procedure, making sure there are no select code conflicts and that the card is firmly seated in an even-numbered slot. If the message still does not appear, call your HP Service Representative for assistance.



---

## The Next Step

You have now installed the 3270 Coax Interface.

The following “Worksheet Entries” contain information needed to use the 3270 Coax Interface with various language/operating systems. Refer to the table for the system you’ll be using.

Copy this information to a worksheet (worksheets are found at the end of Step 1) or simply remember to refer here when you need it. **If you changed the select code in step 2-b, write in your new select code instead of 22.**

When finished, you’ll be ready to install your next peripheral or interface.

---

### BASIC System Worksheet Entry

Interface Name	Select Code	Driver Name
HP 98695A	22	-

---

### Pascal Workstation Worksheet Entry

Interface Name	Select Code	Module Name
HP 98695A	22	-

---

# Installing the HP 98562-66530 Human (System) Interface Board

## Description

The HP 98562-66530 Human Interface board (also called the System Interface board) includes an RS-232C Serial interface, an HP-HIL interface, a standard-speed HP-IB interface, a DMA controller, and a Local Area Network (LAN) interface. You can also get an optional Disc interface in addition to those mentioned above.

## Support

You can use the Human (System) Interface board with Series 300 Model 330 and 350 computers.

Operating/language system support is as follows:

- **BASIC:** supported on revision 5.0 or later (except for the LAN interface, which is not supported).
- **Pascal Workstation:** supported on revision 3.2 or later (except for the LAN interface, which is not supported).
- **HP-UX Operating System:** supported on revision 5.2 or later.

# Human (System) Interface Board Installation Procedure

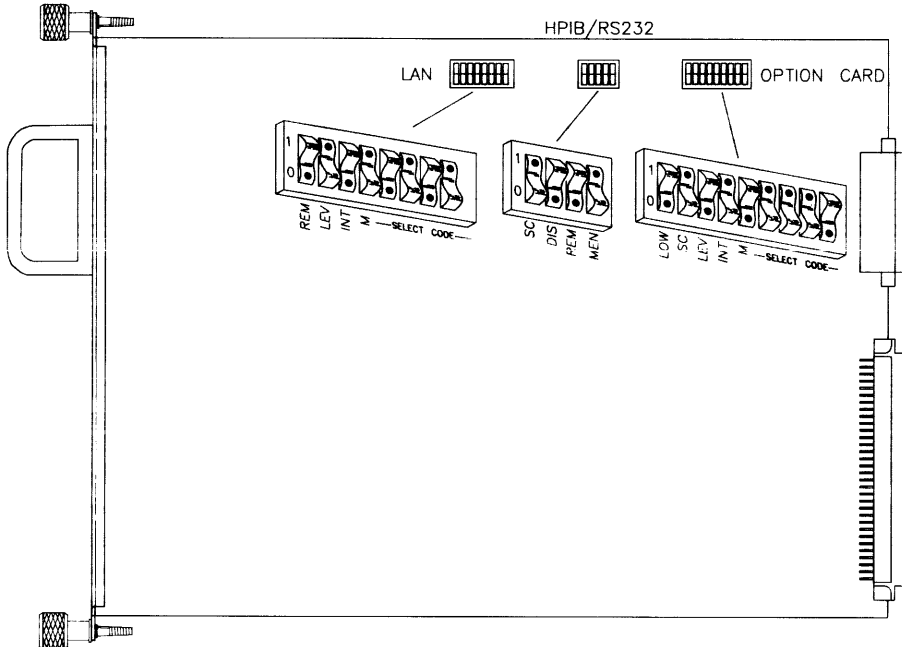

**Figure 5-19. Human (System) Interface board switches**

## 1. Play It Safe.

- a. Turn your computer off and unplug the power cord.
- b. Remove the Human (System) Interface board from the back of your computer by loosening the two thumb screws and pulling on the handle. Be careful to handle the card only by its edges and metal end plate, as the card may be easily damaged by electrostatic discharge (static zap).
- c. Place the card on a static-free surface.
- d. **Do not** disconnect the option card or its cable.

## Configure the HP-IB Interface

### 2. Set the HP-IB System Controller Switch.

---

#### CAN YOU SKIP THIS STEP?

Unless you intend to connect two computers together with this interface, you can skip to step 3. The interface is configured to be system controller and need not be changed.

---

- a. Find the group of four switches labeled **HPIB/RS232**. The switch labeled **SC** in this group is the System Controller switch (see figure 5-19).
- b. If connecting two computers together via HP-IB, only one of them may be set to system controller. To change this interface to non-system controller, move the System Controller switch to the **0** position (the opposite of that shown in figure 5-19).

**Note:** If you will be connecting a disc drive, printer, plotter or other peripheral to this interface, *and* you will be using an HP Series 200/300 operating system, **do not** set this switch to non-system controller.

## Configure the RS-232C Serial Interface

### 3. Set the RS-232 Disable Switch.

---

#### CAN YOU SKIP THIS STEP?

The interface is shipped from the factory with the RS-232C Serial interface *enabled* (meaning you can use the interface). If you intend to use this RS-232C interface, skip to step 4. If you do not intend to use this RS-232C interface, and are using another interface at select code 9, continue with this step. Once disabled, this interface will not be recognized by the boot ROM and will not occupy select code 9.

---

- a. Find the group of four switches labeled **HPIB/RS232**. The switch labeled **DIS** in this group is the RS-232 Disable switch (see figure 5-19).
- b. To disable the RS-232C Serial interface, move the **DIS** switch to the **1** position (the opposite of that shown in Figure 5-19).

If you later want to enable the RS-232C Serial interface, move the switch back to the **0** position as shown in figure 5-19.

#### 4. Set the RS-232 Remote Terminal Enable Switch.

---

### CAN YOU SKIP THIS STEP?

The interface is shipped from the factory with the remote terminal enable switch set to local mode. If you intend to connect a terminal to the RS-232C interface, and want this terminal to be the system console, continue with this step. Otherwise, skip to step 5.

---

- a. Find the group of four switches labeled **HPIB/RS232**. The switch labeled **REM** in this group is the Remote Terminal Enable switch (see figure 5-19).
- b. Set the **REM** switch as follows:
  - If you are connecting a terminal to this interface and want this terminal to be the system console, set this switch to **1**, which is the *opposite* of that shown in Figure 5-19.
  - If you are connecting a terminal to this interface but **do not** want this terminal to be the system console, or if you are connecting any other device, set this switch to **0** as shown in Figure 5-19.

#### 5. Set the Modem Lines Enable Switch.

- a. Find the group of four switches labeled **HPIB/RS232**. The switch labeled **MEN** in this group is the Modem Lines Enable switch (see figure 5-19).
- b. Set the **MEN** switch as follows:
  - If you intend to connect an HP 2601A printer, an HP 2686A *Laserjet* printer, an HP 92205A/C Hayes *Smartmodem*, or a *uucp*, set this switch to **1** as shown in Figure 5-19.
  - If you intend to connect a terminal or the HP 39800/01A bar code reader, set this switch to **0**, which is the *opposite* of that shown in Figure 5-19.

## Configure the LAN Interface

### 6. Set the LAN Select Code

---

#### CAN YOU SKIP THIS STEP?

If you also have an SRM interface installed in your computer (at select code 21), you must change the select code of the LAN interface to an unused value; continue with this step. Otherwise, skip to step 7. The select code is preset to 21 and need not be changed.

---

- a. Find the group of eight switches labeled **LAN**. The five switches labeled **M** (for Most-significant bit) and **SELECT CODE** in this group are the LAN Select Code switches (see figure 5-19).
- b. Set the LAN Select Code switches to one of the four select codes given below, unless you have used them elsewhere.

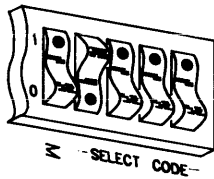

Select Code 23

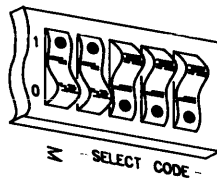

Select Code 24

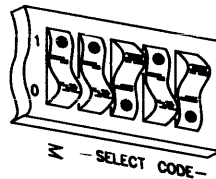

Select Code 26

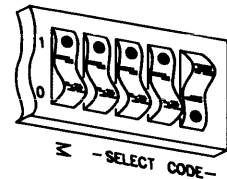

Select Code 30

### 7. Set the LAN Interrupt Level.

---

#### CAN YOU SKIP THIS STEP?

The LAN interface is preset to interrupt level 5, the setting required by HP-UX. Unless you are certain that interrupt level 5 is inappropriate for your application, leave the interrupt level setting alone and skip to step 8.

---

- a. Find the group of eight switches labeled **LAN**. The two switches labeled **INT** and **LEV** in this group are the LAN Interrupt Level switches (see figure 5-19).
- b. Set the LAN Interrupt Level switches according to the following table:

<b>Interrupt Level</b>	<b>LEV</b>	<b>INT</b>
3	0	0
4	0	1
5	1	0
6	1	1

**8. Set the Local/Remote Switch.**

---

**YOU CAN SKIP THIS STEP!**

The interface is shipped from the factory with the remote/local switch set to local mode (0). We recommend that you leave this setting alone.

---

**Configure the Optional Disc Interface (If Present)**

**9. Set the Disc Interface Select Code.**

---

**CAN YOU SKIP THIS STEP?**

If this is your first (or only) Disc interface, you can skip to step 10. The select code is preset to 14 and need not be changed. (Note: this built-in Disc interface is equivalent to an HP 98625B interface card.)

---

- a. Find the group of nine switches labeled **OPTION CARD**. The five switches labeled **M** (for Most-significant bit) and **SELECT CODE** in this group are the Select Code switches (see figure 5-19).

- b. Set the Select Code switches to one of the four select codes given below, unless you have used them elsewhere.

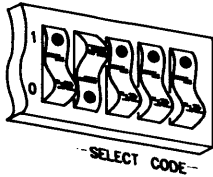

Select Code 23

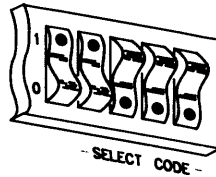

Select Code 24

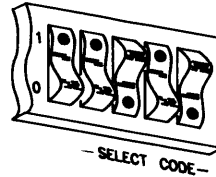

Select Code 26

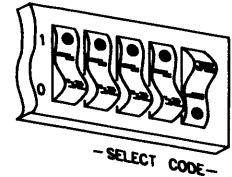

Select Code 30

10. Set the Disc Interface Interrupt Level.

---

### CAN YOU SKIP THIS STEP?

If you are using HP-UX, you can skip to step 11. The interrupt level is preset to 4 and need not be changed. **Do not set any other interface (except for the HP 98629A SRM interface) to interrupt level 4.**

If you will *not* be using HP-UX and want to change the interrupt level, continue with this step.

---

- a. Find the group of nine switches labeled **OPTION CARD**. The two switches labeled **INT** and **LEV** in this group are the Interrupt Level switches.
- b. Set the Interrupt Level switches according to the following table:

Interrupt Level	LEV	INT
3	0	0
4	0	1
5	1	0
6	1	1



## 11. Set the Optional Disc Interface System Controller Switch.

---

### CAN YOU SKIP THIS STEP?

Unless you intend to connect two computers together with this interface, you can skip to step 12. The interface is configured to be system controller and need not be changed.

---

- a. Find the group of nine switches labeled **OPTION CARD**. The switch labeled **SC** in this group is the System Controller switch (see figure 5-19).
- b. If connecting two computers, only one of them may be set to system controller. To change this interface to non-system controller, change the System Controller switch to **0** (the opposite of that shown in figure 5-19).

**Note:** If you will be connecting a disc drive or other peripheral to this interface, *and* you will be using an HP Series 200/300 operating system, **do not** set this switch to non-system controller.

## 12. Set the Optional Disc Interface Low/High Speed Switch.

---

### CAN YOU SKIP THIS STEP?

The Low/High Speed switch is preset to **0**, “high speed,” as shown in Figure 5-19. This setting is appropriate for most applications. If you want to change this setting, continue with step 12; otherwise skip to step 13.

---

- a. Find the set of nine switches labeled **OPTION CARD**. The switch labeled **LOW** in this group is the Low/High Speed switch (see figure 5-19).
- b. Set this switch as follows:
  - To set this switch to “low speed,” set the **LOW** switch to **1**, which is opposite of that shown in Figure 5-19.
  - To set this switch to “high speed,” set the **LOW** switch to **0** as shown in Figure 5-19.

### 13. Insert the Interface.

- a. Re-insert the Human (System) Interface board into the slot you removed it from and tighten the thumb screws to secure it.

### 14. Record the Select Codes.

- a. Make a note that the following select codes have been used and are no longer available:
  - **7** - the built-in, standard-speed HP-IB interface.
  - **9** - the built-in RS-232 Serial interface (unless you disabled the interface in step 3).
  - **21** - the built-in LAN interface (unless you changed the select code in step 6).
  - **14** - the optional Disc interface (unless you changed the select code in step 9 or did not purchase this option).

Use the “Select Code Record” form on the Step 5 tab for this purpose.

## Verification Test

1. Plug in the power cord. Turn your computer on and hold down the space bar a few seconds.
2. Check the list of components displayed on the left-hand side of the screen:
  - If the message, **HPIB**, appears in the list, you have correctly installed the built-in, standard-speed HP-IB interface.
  - If the message, **HP98644 at 9**, appears in the list, you have correctly installed the built-in RS-232C Serial interface, and the interface is enabled.
  - If the message, **HP98643 at 21**, appears in the list, you have correctly installed the built-in LAN interface. (Note: **21** will be replaced by another number if you changed the select code.)
  - If the message, **HP98625 at 14**, appears in the list, you have correctly installed the optional Disc interface. (Note: **14** will be replaced by another number if you changed the select code.)

If any of these messages does not appear, make sure there are no select code conflicts and that the board is firmly seated in the slot. If you still have problems, call your HP Service Representative for assistance.

---

## The Next Step

You have now installed the Human (System) Interface board.

The following “Worksheet Entries” contain information needed to use the interfaces with various language/operating systems. Refer to the table for your system.

Copy this information to a worksheet (worksheets are found at the end of Step 1) or simply remember to refer here when you need it. **If you changed the select code of any of the interfaces, write in your new select code instead of the one listed.**

When finished, you’ll be ready to install your next peripheral or interface.

---

## BASIC System Worksheet Entry

Interface Name	Select Code	Driver Name
Built-in HP-IB	7	HPIB
Built-in RS-232C (HP 98644) <sup>1</sup>	9	SERIAL
Built-in Disc (HP 98625B) <sup>2</sup>	14	FHPIB

---

<sup>1</sup> Do not make this entry if you disabled the RS-232C interface in step 3.

<sup>2</sup> Do not make this entry if you did not purchase the optional Disc interface.

---

## Pascal Workstation Worksheet Entry

Interface Name	Select Code	Module Name
Built-in HP-IB	7	HPIB
Built-in RS-232C (HP 98644) <sup>1</sup>	9	RS232
Built-in Disc (HP 98625B) <sup>2</sup>	14	DISC_INTF & DMA

---

## HP-UX System Worksheet Entry

Interface Name	Select Code
Built-in HP-IB	7
Built-in RS-232C (HP 98644) <sup>1</sup>	9
Built-in LAN (HP 98643)	21
Built-in Disc (HP 98625B) <sup>2</sup>	14

---

<sup>1</sup> Do not make this entry if you disabled the RS-232C interface in step 3.

<sup>2</sup> Do not make this entry if you did not purchase the optional Disc interface.

---

# Installing the HP 98548/49/50A High Resolution Video Boards

## Description

The HP 98548/49/50A High Resolution Video boards output video from the host computer to the following set of HP High Resolution Monitors:

- HP 98548A board for High Resolution (1024×768 pixel) Monochrome Monitors.
- HP 98549A board for High Resolution (1024×768 pixel) Color Monitors.
- HP 98550A board for High Resolution (1280×1024 pixel) Color Monitors.

## Support

The HP 98548/49/50A High Resolution Video Boards are supported on Series 300 computers. See your HP Sales Representative for further information.

Operating/Language system support is as follows:

- **BASIC:** not supported.
- **Pascal Workstation:** not supported.
- **HP-UX Operating System:** supported on revision 5.5 or later.

# High Resolution Video Board Installation Procedure

## 1. Play It Safe

- a. Turn your computer OFF and unplug the power cord.
- b. Remove the High Resolution Video Board from its envelope, being careful to handle the card only by its edges. The card may be easily damaged by electrostatic discharge (static zap).
- c. Place the card on the envelope.

## 2. If you are upgrading a computer which has video furnished by a combination processor/video board, continue with this step. Otherwise, skip to step 3.

- a. Turn the monitor power OFF and disconnect the existing monitor and video cable.
- b. Remove the top wide slot cover plate from the back of the computer (see Figure 5-20).

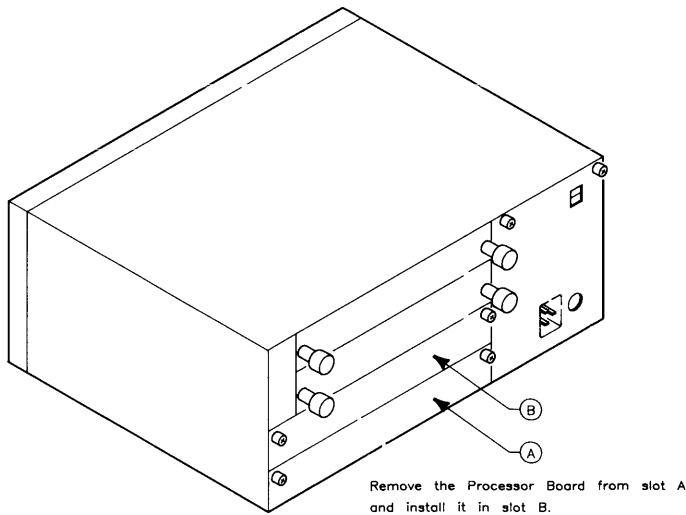

**Figure 5-20. Processor Board Placement**

- c. Loosen the two captive screws securing the processor board. You may need a Pozidriv screwdriver to loosen them.
- d. Slide the processor board out of the backplane and place it on a static-free surface. The bag which the new video board is packaged in is a good place.
- e. Locate the Display Disable switch (see Figure 5-21).

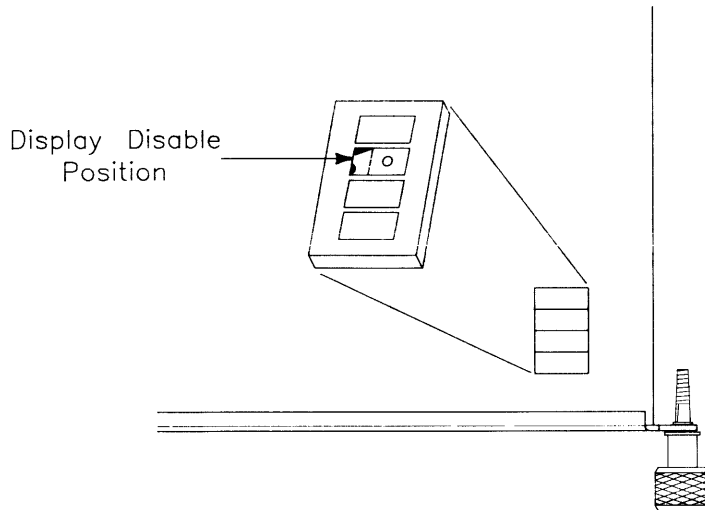

**Figure 5-21. Display Disable Switch**

- f. Set the switch to the Display Disable position.
- g. If there is a grounding clip on the top edge of the processor board back plate, remove it.
- h. Re-install the processor board in the **upper wide** backplane slot and tighten the captive fasteners.
- i. Now continue with Step 4 in the Installation Procedure.

3. **Follow these steps to install a video board in a computer which either has an existing video board or does not have video:**
  - a. Turn the monitor OFF and disconnect the existing monitor and video cables (if any).
  - b. Remove the existing video board or empty slot cover plate from the bottom wide slot on the back of the computer (see Figure 5-22). You may need a Pozidriv screwdriver to loosen it.

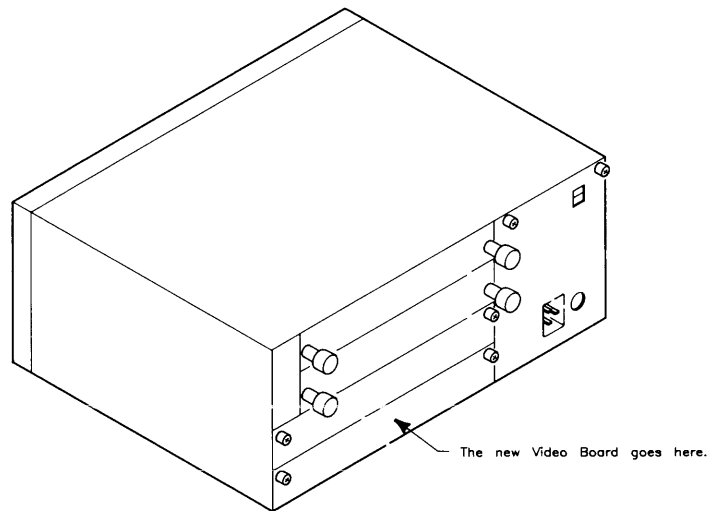
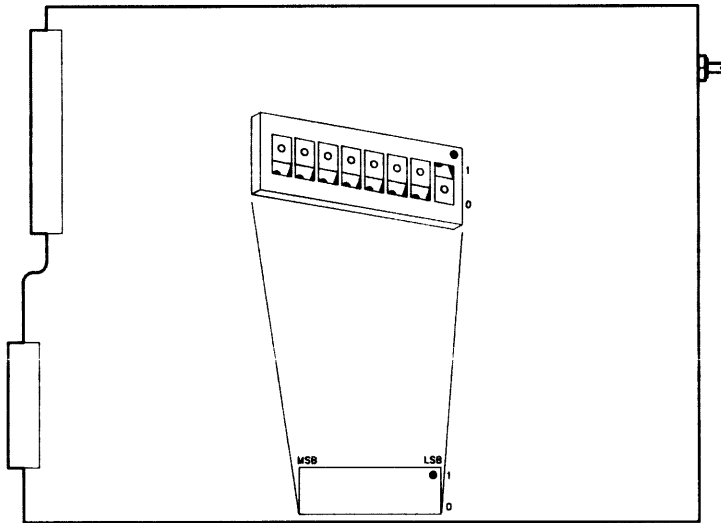

**Figure 5-22. Video Board Placement**



#### 4. Complete the Installation Procedure

- a. Set the video board's eight configuration switches as shown in Figure 5-23.



**Figure 5-23. Video Board Configuration Switches**

- b. Press the video board into the connector and tighten the captive fasteners. You may need a Pozidriv screwdriver.
- c. Connect the included video cable or cable set to the new video board and to the new monitor.
- d. Connect the power cord to the monitor and turn the power ON.
- e. Re-connect the power cord to the computer and turn the power ON.

---

## The Next Step

You have now installed the HP 98548/49/50A High Resolution Video Board.

The following “Worksheet Entry” contains information needed to use the High Resolution Video Board with the HP-UX operating system.

Copy this information to a worksheet (worksheets are found at the end of Step 1) or simply remember to refer here when you need it.

When finished, you’ll be ready to install your next peripheral or interface.

---

## HP-UX System Worksheet Entry

Interface Name	Select Code
HP 98548/49/50A	-

---

# Installing the HP 98724A and 98725A Local Graphics Bus Interface

## Description

The HP 98724A/25A Local Graphics Bus (LGB) interface card provides a connection between the HP 98720 Graphics Display Station and the computer.

## Support

The HP 98724A LGB interface card is supported on Series 300 Model 320 computers. The HP 98725A LGB interface card is supported on Series 300 Model 330 and 350 computers.

Operating/Language system support is as follows:

- **BASIC:** not supported.
- **Pascal Workstation:** not supported.
- **HP-UX Operating System:** The HP 98724A is supported on revision 5.18 or later and the HP 98725A is supported on revision 5.2 or later.

## HP 98724A/25A Installation Procedure

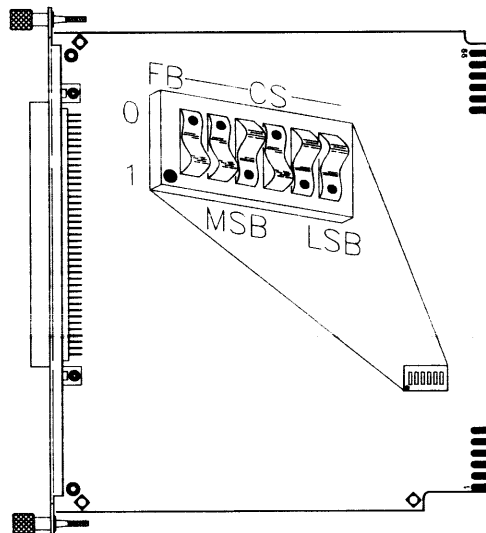
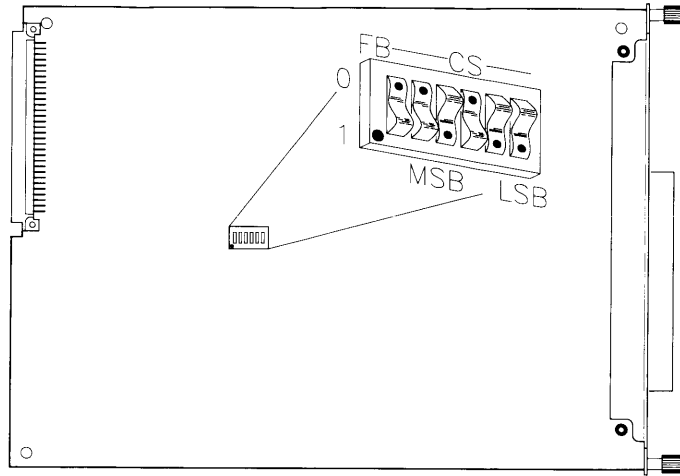

Figure 5-24. HP 98724A LGB Interface Switches



**Figure 5-25. HP 98725A LGB Interface Switches**

**1. Play It Safe.**

- a. Turn your computer off and unplug the power cord.
- b. Remove the HP 98724A/25A from its envelope, being careful to handle the card by its edges and metal end plate. The card may be easily damaged by electrostatic discharge (static zap).
- c. Place the card on the envelope.

**2. Set the Frame Buffer Address and Select Code.**

---

**CAN YOU SKIP THIS STEP?**

If this is the first (or only) LGB card you are installing and you want to use the Graphics Display Station as the system console, you can skip to step 3. Your LGB interface card has been preset to an internal addressing mode (as shown in Figures 5-24 and 5-25).

If you have two Graphics Display Stations, only one of them may be set to internal addressing mode, so you should follow the directions in step 2 when installing the second LGB card.

---

- a. Find the set of six switches labeled SW1 on the HP 98724A/25A interface card (see Figures 5-24 and 5-25). The switch labeled FB determines the Frame Buffer address, and the other five switches labeled CS (for Control Space) determine the interface's select code.
- b. To use the Graphics Display Station as a graphics output device *only*, you need to set the switches to an external addressing mode. Set these switches to one of the three select codes given below, unless you have used them elsewhere. Refer to the installation note that came with the interface if you need additional switch settings.

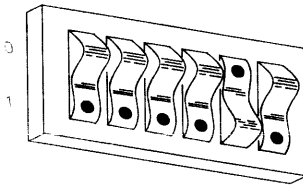

**Select Code 26-27**

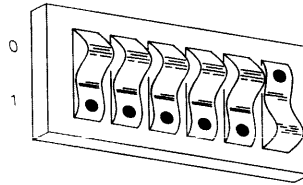

**Select Code 28-29**

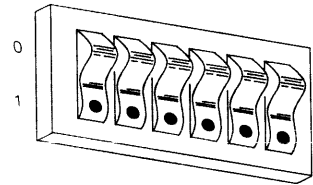

**Select Code 30-31**

### 3. Insert the LGB Interface Card.

- a. Insert the HP 98724A/25A, component side up, into an empty I/O slot in your computer. Tighten the thumb screws on the metal end plate until the end plate is flush with the back of the computer.
- b. If you have other interface or accessory cards to install, leave the cover plates off; otherwise replace them.

### 4. Record the Select Code.

- a. If you set the select code in step 2, record it on the "Select Code Record" form on the Step 5 tab so that you will know in the future that it has been used and is no longer available. If you did not change the switches from their original settings, you need not worry about a select code, since the internal code for the system console is used.

---

#### **NOTE**

Installation of the HP 98720 Graphics Display Station is covered in Step 8, "Adding Plotters and Other Graphics Devices."

---

---

## The Next Step

You have now installed the HP 98724A/25A local Graphics Bus Interface.

The following “Worksheet Entries” contain information needed to use the Graphics Display Station Interface with HP-UX.

Copy this information to a worksheet (worksheets are found at the end of Step 1) or simply remember to refer here when you need it.

When finished, you’ll be ready to install your next peripheral or interface.

---

## HP-UX System Worksheet Entry

Interface Name	Select Code <sup>1</sup>
HP 98724A/25A	-

---

<sup>1</sup> If you changed the select code from the default setting, write it in here.

---

# Installing the HP 98265A Small Computer Systems Interface (SCSI)

## Description

The HP 98265A SCSI Card allows you to transfer data to and from disc drives at high-speed transfer rates.

## Support

The HP 98265A is supported on Series 300 Model 330 and 350 computers.

Operating/Language system support is as follows:

- **BASIC:** not supported.
- **Pascal Workstation:** not supported.
- **HP-UX Operating System:** supported on revision 6.0 or later.

## HP 98265A SCSI Installation Procedure

1. Play It Safe.
  - a. Turn your computer off and unplug the power cord.
  - b. Remove the SCSI Interface from its envelope, being careful to handle the card only by its edges and metal end plate. The card may be easily damaged by electrostatic discharge (static zap).
  - c. Place the card on the envelope.

2. Locate the System Interface Board.

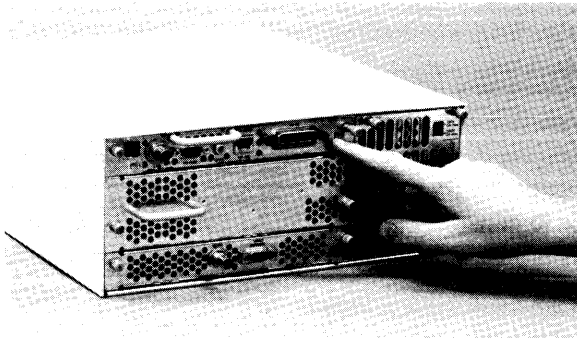

**System Interface Board**

3. Loosen the screws on the System Interface Board and slide it out far enough to expose the large connector.

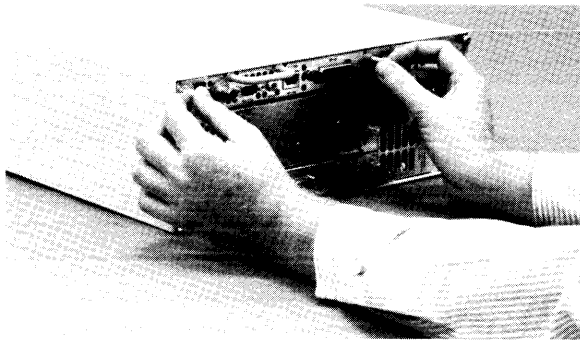

**Slide out System Interface Board**



4. Slide the left-hand flange out and rotate it down.

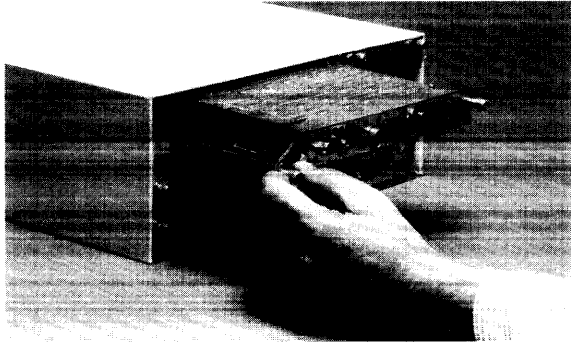

#### **Left-hand Flange**

5. Remove existing interface card.

---

#### **CAN YOU SKIP THIS STEP?**

If there is no interface card currently mounted on the System Interface Board, skip to step 6.

---

- a. Remove the existing cable by pulling it away from the interface card.

- b. Remove the four Pozidriv screws securing the interface card to the System Interface Board.

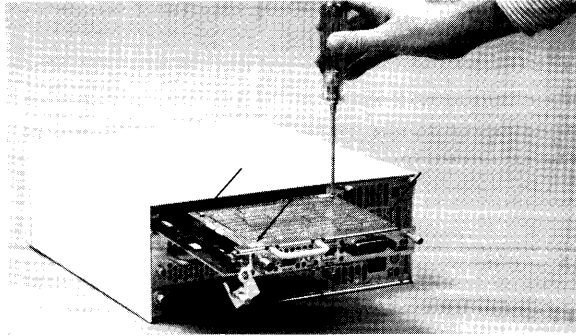

#### **Pozidriv Screws**

- c. Gently pull the interface card straight up and remove it from the System Interface Board.

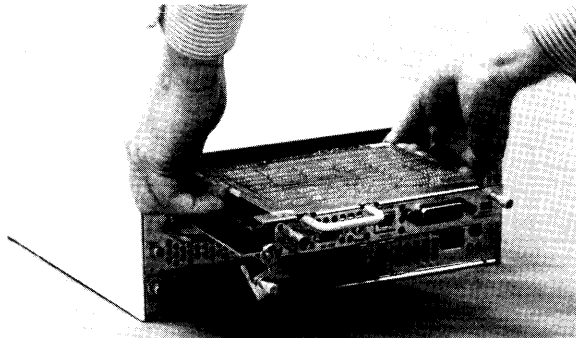

#### **Removing the Existing Interface Card**

- d. Wrap the interface card in static-free material and set it and the cable aside.

6. Hold the SCSI card with the component side down and with the cable connector to the left.

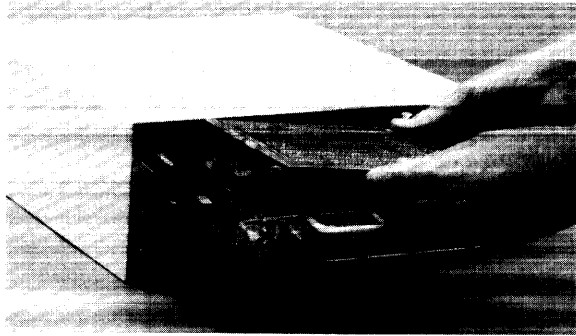

#### **Position the SCSI Card**

7. Press the connector on the SCSI card into the connector on the System Interface Board.

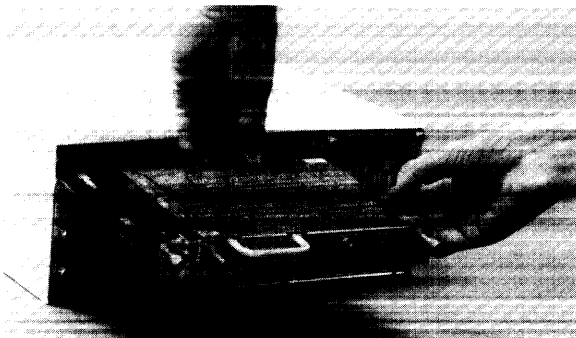

#### **Joining the Connectors**

8. Fasten the card to the board with the four screws provided.

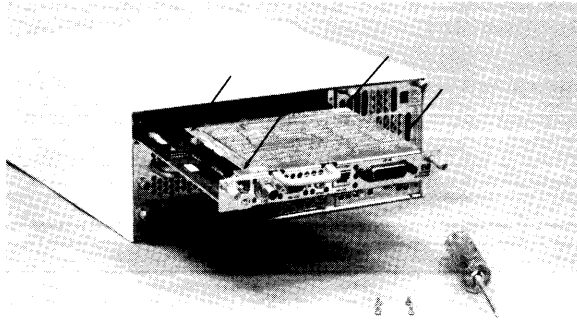

### **Locating the Four Screws**

9. Attach the cable.

a. Locate the interface end of the cable.

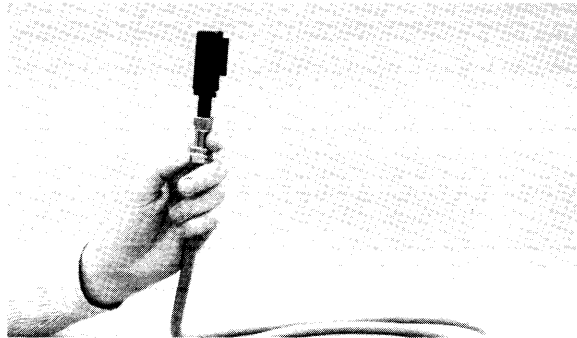

### **Interface End of Cable**

- b. Slide the connector onto the socket on the interface card.

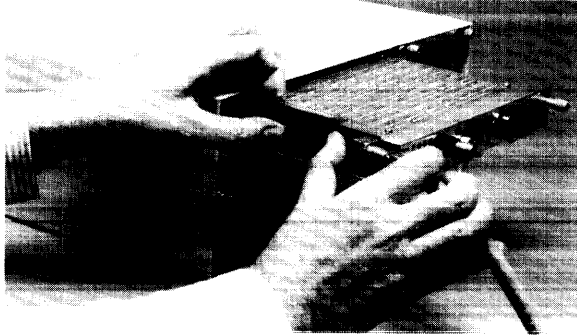

**Connecting Cable to Interface Card**

- c. Press the cable into the cable clamp.

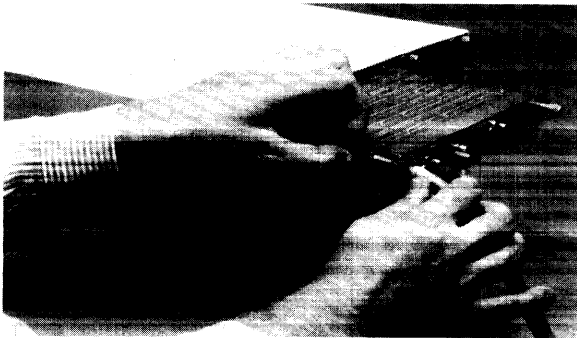

**Cable Clamp**

d. Rotate the left-hand flange up and slide it into place.

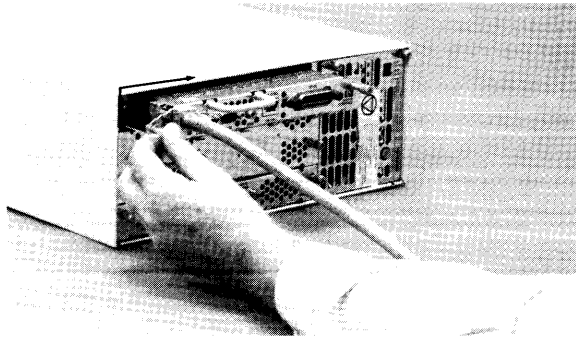

**Sliding Left-hand Flange Into Place**

10. Slide the System Interface Board into the computer and tighten the two screws.

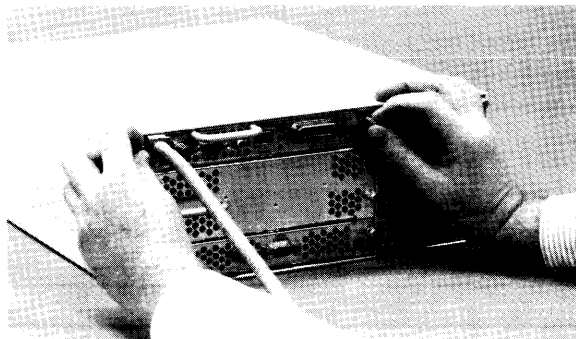

**Fasten Two Screws**

---

## The Next Step

You have now installed the SCSI interface.

The following “Worksheet Entry” contains information needed to use the SCSI interface with HP-UX.

Copy this information to a worksheet (worksheets are found at the end of Step 1) or simply remember to refer here when you need it.

When finished, you’ll be ready to install your next peripheral or interface.

### HP-UX Notes

To connect a SCSI-compatible disc drive to the SCSI interface:

1. Turn your computer and disc drive off, if they are not already off.
2. Make sure the disc drive is a single-ended SCSI disc drive.
3. Attach the cable coming from the SCSI interface to one of the two connectors on the disc drive (it doesn’t matter which one). Press fully in.
4. Place the terminator (supplied with the SCSI interface card) fully on the other connector on the disc drive.
5. Select a bus address not currently used by any other device on the bus.
6. Turn on the power to the disc drive **BEFORE** turning the power on to the computer.

Once you have set up your SCSI disc drive(s) and properly connected the drives to the computer, you are ready to access the driver using HP-UX. Remember that the terminator must be attached to the second connector on the disc drive (step d above).

The following worksheet entry contains information needed to use your SCSI disc drive.

---

## HP-UX System Worksheet Entry

Interface Name	Select Code
HP 98265A	14

- The select code for the SCSI interface card is set by the select code switches found on the System Interface Board. The default setting (set at the factory) is **14**.

---

### NOTE

Both the SCSI and the HP 98625A/B interfaces are preset to select code 14. If you have both SCSI and HP 98625A/B interfaces, change the select code of the HP 98625A/B Interface to an unused value.

---

- The block-mode major number for SCSI interface is **7**.
- The character-mode major number for the SCSI interface is **47**.
- The minor number for a SCSI interface at select code 14 is  $0x0e0n00$ , where  $n$  is the number that identifies the address of the disc drive.

For instance, suppose you are using an HP 7959S disc drive:

Device Name	Path Name	File Type	Major Number	Minor <sup>1</sup> Number	Interleave Factor
HP 7959S	<i>dev/dsk/0s0</i>	b	7	0x0e0n00	1
HP 7959S	<i>dev/rdisk/0s0</i>	c	47	0x0e0n00	1

---

<sup>1</sup>  $n$  is a number that identifies the address. Replace  $n$  with a 0 if the address was set to 0, use 2 if the address was set to 2, and so on.





---

# HP-UX Mass Storage Device File Record

## Disc Drives

Device Name	Block Path Name	Raw Path Name
	<i>/dev/dsk/0s0</i>	<i>/dsk/rdsk/0s0</i>
	<i>/dev/dsk/1s0</i>	<i>/dsk/rdsk/1s0</i>
	<i>/dev/dsk/2s0</i>	<i>/dsk/rdsk/2s0</i>
	<i>/dev/dsk/3s0</i>	<i>/dsk/rdsk/3s0</i>
	<i>/dev/dsk/4s0</i>	<i>/dsk/rdsk/4s0</i>
	<i>/dev/dsk/5s0</i>	<i>/dsk/rdsk/5s0</i>
	<i>/dev/dsk/6s0</i>	<i>/dsk/rdsk/6s0</i>
	<i>/dev/dsk/7s0</i>	<i>/dsk/rdsk/7s0</i>
	<i>/dev/dsk/8s0</i>	<i>/dsk/rdsk/8s0</i>
	<i>/dev/dsk/9s0</i>	<i>/dsk/rdsk/9s0</i>
	<i>/dev/dsk/10s0</i>	<i>/dsk/rdsk/10s0</i>
	<i>/dev/dsk/11s0</i>	<i>/dsk/rdsk/11s0</i>
	<i>/dev/dsk/12s0</i>	<i>/dsk/rdsk/12s0</i>

## Cartridge Tape Drives

Device Name	Block Path Name	Raw Path Name
	<i>/dev/ct/0s0</i>	<i>/dev/rct/0s0</i>
	<i>/dev/ct/1s0</i>	<i>/dev/rct/1s0</i>
	<i>/dev/ct/2s0</i>	<i>/dev/rct/2s0</i>
	<i>/dev/ct/3s0</i>	<i>/dev/rct/3s0</i>

## Mag. Tape Drives

Device Name	Block Path Name <sup>1</sup>	Raw Path Name
	<i>/dev/mt/0s0</i>	<i>/dev/rmt/0s0</i>
	<i>/dev/mt/1s0</i>	<i>/dev/rmt/1s0</i>

---

<sup>1</sup> Currently unsupported, but reserved.

# Adding Mass Storage Devices

If you need to install any of the products listed below, turn to the indicated page number and follow the instructions.<sup>1</sup> Otherwise, move on to Step 7.

Device Name	Page Number
Model 226/236 Internal Disc Drives	See page 6-2
HP 7907A Disc Drive	See page 6-4
HP 7911, 7912, 7914 Disc/Tape Drives	See page 6-10
HP 7933 and 7935 Disc Drives	See page 6-20
HP 7936H and 7937H Disc Drives	See page 6-25
HP 7941, 7942, 7945, 7946 Disc/Tape Drives	See page 6-30
HP 7957A and 7958A Disc Drives	See page 6-35
HP 7971A Tape Drive	See page 6-39
HP 7974A Tape Drive	See page 6-43
HP 7978A Tape Drive	See page 6-48
HP 9121 and 9122 Flexible Disc Drives	See page 6-53
HP 9125S and 9127A Flexible Disc Drives	See page 6-58
HP 9133 and 9134 Disc Drives	See page 6-62
HP 9144A Tape Drive	See page 6-73
HP 9153A and 9154A Disc Drives	See page 6-78
HP 9895A Disc Drive	See page 6-89
HP 98255A EPROM Memory Card	See page 6-94
HP 98259A Bubble Memory Card	See page 6-99
Determining Your BASIC Msvs	See page 6-105
Determining Pascal Unit Numbers	See page 6-108
Determining HP-UX Minor Numbers	See page 6-117

<sup>1</sup> The "Worksheet Entries" in this section assume you will set your mass storage device's HP-IB address to 0, 2 or 3, and that you will connect it to an interface that is set to its preset select code (7 for built-in HP-IB, 14 for HP 98625 Disc, or 8 for HP 98624 HP-IB). If you use a different HP-IB address and/or select code, refer to "Msvs/Unit Number/Minor Number" section to determine your BASIC msvs (mass storage volume specifier), Pascal unit number or HP-UX minor number.

---

## Installing Model 226/236 Internal Disc Drives

### Description

The Series 200 Model 226 has one built-in disc drive; the Series 200 Model 236 computer has two built-in disc drives. No additional set up is required for these drives, but you will need information on how to access them with your language/operating system. Refer to the instructions below.

---

### The Next Step

The following “Worksheet Entries” contain information needed to use the internal disc drives with various language/operating systems. Refer to the entries for the system you’ll be using (BASIC, Pascal or HP-UX).

Copy this information to a worksheet (worksheets are found at the end of Step 1) or remember to refer here when you need it.

When finished, you’ll be ready to install your next peripheral.

---

### BASIC System Worksheet Entries

Device Name	Msvs	Driver Name	Interleave Factor
Right Drive (Model 226/236)	“:4”	—	0
Left Drive (Model 236)	“:4,1”		0

---

## Pascal Workstation Worksheet Entries

This section contains two tables of information. Choose the one that fits your situation, depending on whether you will or will not boot (load) the Pascal Workstation from an internal drive.

### If You Will Boot from an Internal Drive...

Device Name	Unit Numbers	Module Name	Interleave Factor
Right Drive (Model 226/236)	#3:	...	0
Left Drive (Model 236)	#4:	—	0

### If You Will Not Boot from an Internal Drive...

Device Name	Unit Numbers	Module Name	Interleave Factor
Right Drive (Model 226/236)	#7:	—	0
Left Drive (Model 236)	#8:	—	0

---

## HP-UX System Worksheet Entries

Device Name	Path <sup>1</sup> Name	File Type	Major Number	Minor Number	Interleave Factor
Right Drive (Model 226/236)	/dev/dsk/#s0	b	1	0x000000	0
Right Drive (Model 226/236)	/dev/rdisk/#s0	c	6	0x000000	0
Left Drive (Model 236)	/dev/dsk/#s0	b	1	0x000001	0
Left Drive (Model 236)	/dev/rdisk/#s0	c	6	0x000001	0

<sup>1</sup> # is a number that identifies the disc drive (e.g., 0 for the root disc, 1 for the next disc installed, etc.). Replace # with any unique number, and use the same number in both the /dev/dsk and /dev/rdisk entries (e.g., /dev/dsk/1s0 and /dev/rdisk/1s0). Record the numbers on the Step 6 tab.

---

# Installing the HP 7907A Disc Drive

## Description

The HP 7907A is a Command Set 80 (CS/80) device containing a 20.5 Mbyte fixed disc and a 20.5 Mbyte removable cartridge disc. It connects to Series 200/300 computers via an HP-IB or Disc interface.

## Support

The HP 7907A disc drive is supported on Series 200 Model 217, 220, 226, 236 and 237 computers with boot ROM 3.0 or later, and on all Series 300 computers with boot ROM Rev. A or later.

Operating/Language system support is as follows:

- **BASIC:** supported on revision 3.0 or later with Series 200 computers; supported on revision 4.0 or later with Series 300 computers.
- **Pascal Workstation:** supported on revision 3.0 or later with Series 200 computers; supported on revision 3.1 or later with Series 300 computers.
- **HP-UX Operating System:** supported on revision 2.1 or later with Series 200 computers; supported on revision 5.0 or later with Series 300 computers.

## Before You Begin

Before you connect your disc drive to your computer, refer to the manual(s) that came with the disc drive to:

- Unpack the disc drive.
- Check that your proposed site for the HP 7907A meets environmental requirements.
- Check the voltage setting.
- Check the fuse.

## HP 7907A Disc Drive Installation Procedure

### 1. Play It Safe.

- a. Turn your computer and disc drive off, if they are not already off.

### 2. Select Your Interface.

- a. Select one of the following interfaces, listed in order of preference for optimum disc performance:

- HP 98625 Disc Interface
- Built-in HP-IB Interface

### 3. Set the Address.

- a. On the back of the disc drive, find the set of four switches labeled “HP-IB ADDRESS.”
- b. Set the HP-IB address:
  - If there is only *one* other disc or tape drive (besides this HP 7907A) already connected to the interface, set the “HP-IB ADDRESS” switches to 2 as shown below, unless address 2 has been used elsewhere.

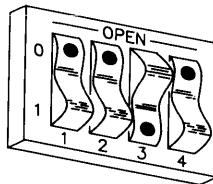

**Address 2**

- If there are *two* other disc or tape drives (besides this HP 7907A) already connected to the interface, set the “HP-IB ADDRESS” switches to 3 as shown below, unless address 3 has been used elsewhere. Refer to the manual that came with your disc drive if you need additional switch settings.

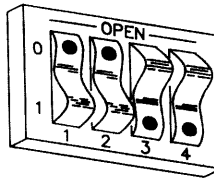

### Address 3

#### 4. Connect the HP 7907A to Your Computer.

- a. Find the HP-IB cable provided with the disc drive.
- b. Connect one end of the HP-IB cable to the HP-IB socket on the back of the HP 7907A. Tighten the thumb screws to secure the connection.
- c. Connect the other end of the HP-IB cable to the interface.

---

#### NOTE

If the interface already has several cables connected to it, connect your HP 7907A cable to one of the other devices on the interface.

---

#### 5. Connect the Power Cord.

- a. Connect the female end of the power cord to the “AC LINE” socket on the back of the disc drive, and connect the other end to your power outlet.

#### 6. Record the Address.

- a. Make a note that address 0 (or the alternate address you chose in step 3) has been used and is no longer available on the interface you selected. Use the “Address Record” form on the Step 6 tab for this purpose.



---

## The Next Step

You have now installed your HP 7907A Disc Drive.

The following “Worksheet Entries” contain information needed to use your disc drives with various language/operating systems. Refer to the entries for the system you’ll be using (BASIC, Pascal or HP-UX).

Copy this information to a worksheet (worksheets are found at the end of Step 1) or remember to refer here when you need it.

When finished, you’ll be ready to install your next peripheral.

---

## BASIC System Worksheet Entries

### HP 7907A Connected to HP 98625 Disc Interface (Select Code 14)

Device Name	Msvs <sup>1</sup>	Driver Name	Interleave Factor
HP 7907A - Fixed Disc	“:,140 $n$ ”	CS80	1
HP 7907A - Removable Disc	“:,140 $n$ ,1”	CS80	1

### HP 7907A Connected to Built-in HP-IB Interface (Select Code 7)

Device Name	Msvs <sup>1</sup>	Driver Name	Interleave Factor
HP 7907A - Fixed Disc	“:,70 $n$ ”	CS80	1
HP 7907A - Removable Disc	“:,70 $n$ ,1”	CS80	1

---

<sup>1</sup>  $n$  is a number that identifies the address (set in step 3 of the Installation Procedure). Replace  $n$  with a 0 if the address was set to 0, use 2 if the address was set to 2, and so on.

---

## Pascal Workstation Worksheet Entries

---

### NOTE

The Pascal Workstation, as shipped, will not be able to access all of the storage capacity of your HP 7907A removable disc. To correct this situation, refer to the "Special Configurations" section of the *Pascal Workstation System* manual.

---

Device Name	Unit Numbers <sup>1</sup>	Module Name <sup>2</sup>	Interleave Factor
HP 7907A - Fixed Disc	#11: thru #30:	DISCHPIB & CS80	1
HP 7907A - Removable Disc	<i>See Note Above</i>	DISCHPIB & CS80	1

---

<sup>1</sup> If you have more than one hard disc drive, the unit number assignments for your HP 7907A may be different from those shown. Refer to the section, "Determining Pascal Unit Numbers," found at the end of this chapter, after you have installed *all* of your discs.

<sup>2</sup> If you are using a high-speed disc interface, include the DISC\_INTF module. If your computer also includes DMA, you also need the DMA module.

## HP 9895A Disc Drive Installation Procedure

### 1. Play It Safe.

- a. Turn your computer and disc drive off, if they are not already off.

### 2. Select Your Interface.

- a. Use either the built-in HP-IB interface or an HP 98624A HP-IB Interface.

### 3. Set the Address.

- a. Remove the front panel of the disc drive by pulling outward on the lower outside corners of each drive access opening.
- b. Find the device address switch. This is a small wheel located along the bottom of the front of the drive.
- c. Set the device address switch:
  - If there is only *one* other disc or tape drive (besides this HP 9895A) already connected to the interface, set the device address switch to 2, unless address 2 has already been used.
  - If there are only *two* other disc or tape drives (besides this HP 9895A) already connected to the interface, set the device address switch to 3, unless address 3 has already been used. If it has, choose any unused address.

#### 4. **Connect the Disc Drive to Your Computer.**

- a. Find the HP-IB cable provided with the disc drive.
- b. Connect one end of the HP-IB cable to the HP-IB socket on the back of the disc drive. Tighten the thumb screws to secure the connection.
- c. Connect the other end of the HP-IB cable to the interface.

---

#### **NOTE**

If the interface already has several cables connected to it, connect your HP 9895A cable to one of the other devices on the interface.

---

#### 5. **Connect the Power Cord.**

- a. Connect the female end of the power cord to the “LINE” socket on the back of the disc drive, and connect the other end to your power outlet.

#### 6. **Record the Address.**

- a. Make a note that address 0 (or the alternate address you chose in step 3) has been used and is no longer available on the interface you selected. Use the “Address Record” form on the Step 6 tab for this purpose.

---

## **The Next Step**

You have now installed your HP 9895A Disc Drive.

The following “Worksheet Entries” contain information needed to use your disc drive with various language/operating systems. Refer to the entries for the system you’ll be using (BASIC, Pascal or HP-UX).

Copy this information to a worksheet (worksheets are found at the end of Step 1) or remember to refer here when you need it.

When finished, you’ll be ready to install your next peripheral.

---

## BASIC System Worksheet Entries

### HP 9895A Connected to Built-in HP-IB Interface (Select Code 7)

Device Name	Msvs <sup>1</sup>	Driver Name	Interleave Factor
HP 9895A Master - Left	“:,70 $n$ ”	DISC	4
HP 9895A Master - Right	“:,70 $n$ ,1”	DISC	4
HP 9895A Slave - Left	“:,70 $n$ ,2”	DISC	4
HP 9895A Slave - Right	“:,70 $n$ ,3”	DISC	4

### HP 9895A Connected to HP 98624 HP-IB Interface (Select Code 8)

Device Name	Msvs <sup>1</sup>	Driver Name	Interleave Factor
HP 9895A Master - Left	“:,80 $n$ ”	DISC	4
HP 9895A Master - Right	“:,80 $n$ ,1”	DISC	4
HP 9895A Slave - Left	“:,80 $n$ ,2”	DISC	4
HP 9895A Slave - Right	“:,80 $n$ ,3”	DISC	4

---

## Pascal Workstation Worksheet Entries

Device Name	Unit Numbers <sup>2</sup>	Module Name	Interleave Factor
HP 9895A - Left	#3:	DISCHPIB & AMIGO	2
HP 9895A - Right	#4:	DISCHPIB & AMIGO	2

<sup>1</sup>  $n$  is a number that identifies the address (set in step 3 of the Installation Procedure). Replace  $n$  with a 0 if the address was set to 0, use 2 if the address was set to 2, and so on.

<sup>2</sup> If you have more than one flexible disc drive, the unit number assignments for your HP 9895A may be different. Refer to the section, “Determining Pascal Unit Numbers,” found at the end of this chapter, after you have installed *all* of your discs.

# HP-UX System Worksheet Entries

## HP 9895A Connected to Built-in HP-IB Interface (Select Code 7)

Device Name	Path <sup>1</sup> Name	File Type	Major Number	Minor <sup>2</sup> Number	Interleave Factor
HP 9895A - Left	<i>/dev/dsk/#s0</i>	b	2	0x070n00	2
HP 9895A - Left	<i>/dev/rdisk/#s0</i>	c	11	0x070n00	2
HP 9895A - Right	<i>/dev/dsk/#s0</i>	b	2	0x070n10	2
HP 9895A - Right	<i>/dev/rdisk/#s0</i>	c	11	0x070n10	2

## HP 9895A Connected to HP 98624 HP-IB Interface (Select Code 8)

Device Name	Path <sup>1</sup> Name	File Type	Major Number	Minor <sup>2</sup> Number	Interleave Factor
HP 9895A - Left	<i>/dev/dsk/#s0</i>	b	2	0x080n00	2
HP 9895A - Left	<i>/dev/rdisk/#s0</i>	c	11	0x080n00	2
HP 9895A - Right	<i>/dev/dsk/#s0</i>	b	2	0x080n10	2
HP 9895A - Right	<i>/dev/rdisk/#s0</i>	c	11	0x080n10	2

<sup>1</sup> # is a number that identifies the disc drive (e.g., 0 for the root disc, 1 for the next disc installed, etc.). Replace # with any unique number, and use the same number in both the */dev/dsk* and */dev/rdisk* entries (e.g., */dev/dsk/1s0* and */dev/rdisk/1s0*). Record the numbers on the Step 6 tab.

<sup>2</sup> n is a number that identifies the address (set in step 3 of the Installation Procedure). Replace n with a 0 if the address was set to 0, use 2 if the address was set to 2, and so on.

---

# Installing HP 98255A EPROM Memory Cards

## Description

The HP98255A EPROM Memory Card allows you to install Erasable Programmable Read Only Memory chips in your computer.

## Support

The HP 98255A EPROM Memory Card is supported on all Series 200 computers with boot ROM 3.0 or later, and on all Series 300 computers with boot ROM Rev. A or later.

Operating/Language system support is as follows:

- **BASIC:** supported on revision 2.1 or later with Series 200 computers; supported on revision 4.0 or later with Series 300 computers.
- **Pascal Workstation:** supported on revision 3.0 or later with Series 200 computers; supported on revision 3.1 or later with Series 300 computers.
- **HP-UX Operating System:** not supported.

## EPROM Memory Card Installation Procedure

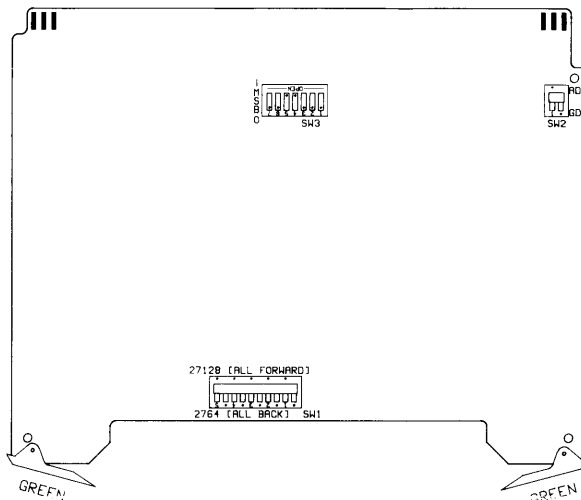

**Figure 6-1. EPROM Memory Card Switches**

### 1. Play It Safe.

- a. Turn your computer off and unplug the power cord.
- b. Remove the EPROM Memory Card from its envelope, being careful to handle the card only by its edges and plastic extractor levers. The card may be damaged by electrostatic discharge (static zap).
- c. Place the card on the envelope.



## 2. Set the EPROM-type Switches.

- a. Find the EPROM-type switches, labeled SW1 on the card, by referring to Figure 6-1.
- b. Set the switches as follows:
  - If you have all 2764-type EPROMs, set the switches to the “all back” position (see Figure 6-1).
  - If you have all 27128-type EPROMs, set the switches to the “all forward” position (see Figure 6-1).

---

### NOTE

You can use only one type of EPROM on each card.

---

## 3. Set the EPROM Address Switches.

- a. Find the EPROM address switches, labeled SW3 on the card, by referring to Figure 6-1.
- b. Set the switches as follows:
  - If you are using the Pascal Workstation, refer to the “Non-Disc Mass Storage” chapter of the *Pascal Workstation System* manual for recommended EPROM address settings. Also keep in mind that the least significant bit switch (labeled 1 in Figure 6-1) must be set to 0 if 27128-type devices are used.
  - If you are using the BASIC Language System, refer to the “EPROM Programming” chapter of the *BASIC Interfacing Techniques* manual for recommended EPROM address settings. Also keep in mind that the least significant bit switch (labeled 1 in Figure 6-1) must be set to 0 if 27128-type devices are used.

## 4. Set the EPROM DTACK Switch.

- a. Find the EPROM DTACK switch, labeled SW2 on the card, by referring to Figure 6-1.
- b. Set the switch to “AD” as shown in Figure 6-1. Both BASIC and the Pascal Workstation require EPROMs to be addressed in the ROM space, which requires auto DTACK (AD).

## 5. Load the EPROMs.

- a. Load the EPROMs into the sockets of the memory cards. Refer to the *98255 EPROM Memory Installation* manual for details.

## 6. Insert the EPROM Memory Card.

- a. Remove the *painted* cover plates from the back of your computer until you find an empty slot near the EPROM Programmer Interface. Use an odd-numbered slot, if possible (slots are numbered from the top down, so the top slot is slot number 1, the next slot down is slot number 2, etc.). **Do not** remove the *silver* cover plates from the bottom of a Series 300 computer.
- b. Insert the EPROM Memory Card, component side up, into the empty slot.
- c. Place the extractor levers flat against the card, and push on the extractor levers with your thumbs until the card is firmly seated in the backplane. You may have to push very hard.
- d. Plug the EPROM Programmer Interface Card's cable into the EPROM Memory Card.

---

## The Next Step

You have now installed your HP 98255A EPROM Memory Card.

The following “Worksheet Entries” contain information needed to use your EPROM Memory Card with various language/operating systems. Refer to the entries for the system you'll be using (BASIC or Pascal).

Copy this information to a worksheet (worksheets are found at the end of Step 1) or remember to refer here when you need it.

When finished, you'll be ready to install your next peripheral.

---

## BASIC System Worksheet Entries

Device Name	Msvs	Driver Name	Interleave Factor
HP 98255, lowest address	“:EPROM”	EPROM	-
HP 98255, 2nd lowest addr.	“:EPROM,0,1”	EPROM	-
HP 98255, 3rd lowest addr.	“:EPROM,0,2”	EPROM	-

---

## Pascal Workstation Worksheet Entry

Device Name	Unit Numbers	Module Name	Interleave Factor
HP 98255	#42:	EPROMS	-

---

### NOTE

Before you can access an EPROM Memory Card from the Pascal Workstation, you must make a few modifications. Refer to the “Special Configurations” and “Non-Disc Mass Storage” chapters of the *Pascal Workstation System* manual for details.

---

---

# Installing the HP 98259A Bubble Memory Card

## Description

The HP 98259A Bubble Memory Card acts like a disc drive. It can store data, programs, operating systems, or perform any other normal mass storage function.

## Support

The HP 98259A Bubble Memory Card is supported on all Series 200 computers with boot ROM 3.0 or later, and on all Series 300 computers with boot ROM Rev. A or later.

Operating/Language system support is as follows:

- **BASIC:** supported on revision 2.1 or later with Series 200 computers; supported on revision 4.0 or later with Series 300 computers.
- **Pascal Workstation:** supported on revision 3.0 or later with Series 200 computers; supported on revision 3.1 or later with Series 300 computers.
- **HP-UX Operating System:** not supported.

---

# HP-UX System Worksheet Entries

## HP 7907A Connected to HP 98625 Disc Interface (Select Code 14)

Device Name	Path <sup>1</sup> Name	File Type	Major Number	Minor <sup>2</sup> Number	Interleave Factor
HP 7907A - Fixed Disc	<i>/dev/dsk/#s0</i>	b	0	0x0e0n00	1
HP 7907A - Fixed Disc	<i>/dev/rdisk/#s0</i>	c	4	0x0e0n00	1
HP 7907A - Removable Disc	<i>/dev/dsk/#s0</i>	b	0	0x0e0n10	1
HP 7907A - Removable Disc	<i>/dev/rdisk/#s0</i>	c	4	0x0e0n10	1

## HP 7907A Connected to Built-in HP-IB Interface (Select Code 7)

Device Name	Path <sup>1</sup> Name	File Type	Major Number	Minor <sup>2</sup> Number	Interleave Factor
HP 7907A - Fixed Disc	<i>/dev/dsk/#s0</i>	b	0	0x070n00	1
HP 7907A - Fixed Disc	<i>/dev/rdisk/#s0</i>	c	4	0x070n00	1
HP 7907A - Removable Disc	<i>/dev/dsk/#s0</i>	b	0	0x070n10	1
HP 7907A - Removable Disc	<i>/dev/rdisk/#s0</i>	c	4	0x070n10	1

---

<sup>1</sup> # is a number that identifies the disc drive (e.g., 0 for the root disc, 1 for the next disc installed, etc.). Replace # with any unique number, and use the same number in both the */dev/dsk* and */dev/rdisk* entries (e.g., */dev/dsk/1s0* and */dev/rdisk/1s0*). Record the numbers on the Step 6 tab.

<sup>2</sup> n is a number that identifies the address (set in step 3 of the Installation Procedure). Replace n with a 0 if the address was set to 0, use 2 if the address was set to 2, and so on.

## Bubble Memory Card Installation Procedure

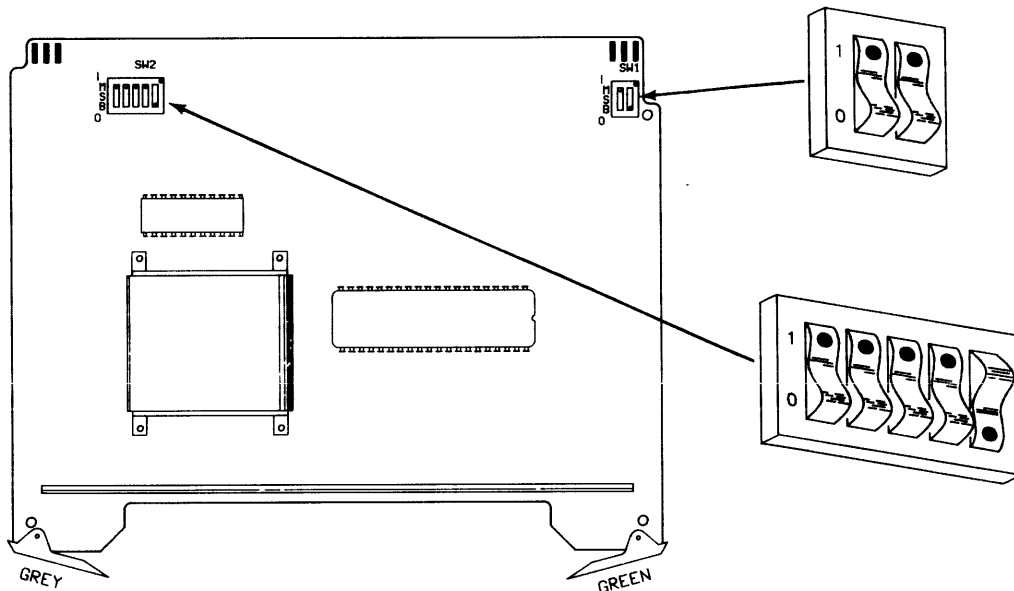

**Figure 6-2. Bubble Memory Card Switches**

### 1. Play It Safe.

- a. Turn your computer off and unplug the power cord.
- b. Remove the Bubble Memory Card from its envelope, being careful to handle the card only by its edges and plastic extractor levers. The card may be damaged by electrostatic discharge (static zap).
- c. Place the card on the envelope.

## 2. Set the Select Code.

---

### CAN YOU SKIP THIS STEP?

If this is the first (or only) HP 98259A Bubble Memory Card you are installing, you can skip to step 3. The select code is preset to 30 and need not be changed.

---

- a. Find the set of five select code switches, labeled SW2 on the card, by referring to Figure 6-2.
- b. Set these switches to one of the three select codes given below, unless you have used them elsewhere. Refer to the manual that came with the card if you need additional switch settings.

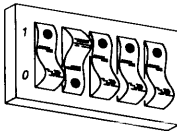

**Select Code 23**

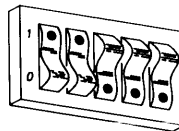

**Select Code 24**

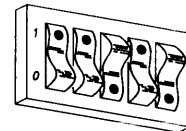

**Select Code 26**

## 3. Set the Interrupt Level.

- a. Find the interrupt level switches, labeled SW1 on the card, by referring to Figure 6-2.
- b. Set the interrupt level as follows:
  - If this is the first (or only) Bubble Memory Card you are installing, set the interrupt level to 6 as shown in Figure 6-2.
  - If this is the second Bubble Memory Card you are installing, set the interrupt level to 5 like this:

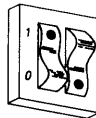

**Interrupt Level 5**

#### 4. Insert the Bubble Memory Card.

- a. Remove the *painted* cover plates from the back of your computer until you find an empty slot. Use an odd-numbered slot, if possible (slots are numbered from the top down, so the top slot is slot number 1, the next slot down is slot number 2, etc.). **Do not** remove the *silver* cover plates from the bottom of a Series 300 computer.
- b. Insert the Bubble Memory Card, component side up, into the empty slot.
- c. Place the extractor levers flat against the card, and push on the extractor levers with your thumbs until the card is firmly seated in the backplane. You may have to push very hard.

#### 5. Record the Select Code.

- a. Make a note that select code 30 (or the alternate select code you chose in step 2) has been used and is no longer available. Use the “Select Code Record” form on the Step 5 tab for this purpose.

---

## The Next Step

You have now installed your HP 98259A Bubble Memory Card.

The following “Worksheet Entries” contain information needed to use your Bubble Memory Card with various language/operating systems. Refer to the entries for the system you’ll be using (BASIC or Pascal).

Copy this information to a worksheet (worksheets are found at the end of Step 1) or remember to refer here when you need it. **If you changed the select code in step 2, write in your new select code instead of 30.**

When finished, you’ll be ready to install your next peripheral.



---

## BASIC System Worksheet Entries

Device Name	Msvs	Driver Name	Interleave Factor
HP 98259	“:,30”	BUBBLE	-

---

## Pascal Workstation Worksheet Entry

Device Name	Unit Numbers	Module Name	Interleave Factor
HP 98259	#42:	BUBBLE	-

---

### NOTE

Before you can access a BUBBLE Memory Card from the Pascal Workstation, you must make a few modifications. Refer to the “Special Configurations” and “Non-Disc Mass Storage” chapters of the *Pascal Workstation System* manual for details.

---



---

## Determining Your BASIC Msvs

In BASIC, every mass storage device is assigned a unique name, called the mass storage volume specifier (Msvs). The Msvs is used to distinguish which drive or volume you want to access. In this section, you will determine the Msvs for each of your mass storage devices.

The form of the Msvs is:

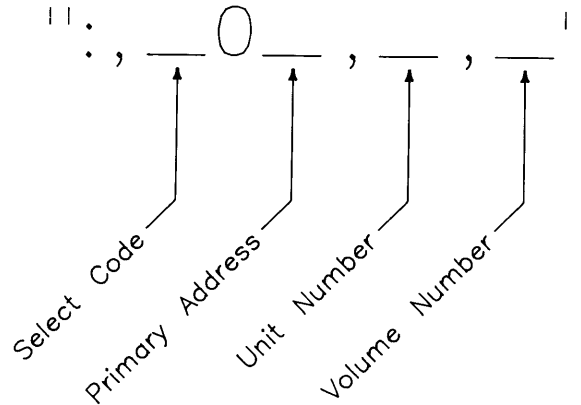

To determine the Msvs for each of your mass storage devices, just fill in the blanks of this form with information from your BASIC System Worksheet. Write each Msvs in the **Msvs** column of your worksheet. (EPROMs are an exception; see the EPROM Memory Card section).

### Rules for Determining Your Msvs

1. Always be sure to include the initial comma, and don't forget the **0** between the select code and the primary address.
2. If the unit number *and* the volume number are either 0 or blank, you may omit both the unit number and the volume number and the commas that precede them.
3. If the volume number is 0 or blank, you may omit the volume number and the comma that precedes it.

A few examples will make this clear:

### Example 1

Suppose your disc has the following characteristics:

Select Code	Primary Address	Unit Number	Volume Number
7	0	0	0

Then, filling in the form, you arrive at the following Msvs:

**”:,700,0,0”**

Notice, however, that both the unit number and the volume number are blank. Therefore, by rule #2, you can omit the unit number and volume number, and use this shortened version of the Msvs:

**”:,700”**

### Example 2

Suppose your disc has the following characteristics:

Select Code	Primary Address	Unit Number	Volume Number
14	2	1	6

Then, filling in the form, you arrive at the following Msvs:

**”:,1402,1,6”**

**Example 3**

Suppose your disc has the following characteristics:

Select Code	Primary Address	Unit Number	Volume Number
8	3	0	

Then, filling in the form, you arrive at the following Msvs:

**”:,803,0”**

Notice that because the Volume Number entry is blank, the volume number and the comma that precedes it are omitted in the Msvs above (see rule #3). In addition, since the unit number is 0, by rule #2 you could further shorten the Msvs to:

**”:,803”**

---

## Determining Pascal Unit Numbers

Follow this procedure to determine which unit numbers the Pascal Workstation has *initially* assigned to your disc. Be aware, however, that unit number assignments may change if you change your system configuration, or if you begin booting the Pascal Workstation from a different disc. See the section “Verifying Unit Numbers” in the *Pascal User’s Guide* to confirm the unit numbers you determine here, *after* you have initialized your discs.

Three procedures are provided:

- Determining Flexible Disc Drive Unit Numbers
- Determining Hard Disc Drive Unit Numbers
- Determining Tape Drive Unit Numbers

**Table 6-1.**

<b>Product Number</b>	<b>Number of Volumes</b>
7907 (fixed)	20
7907 (removable)	20
7911	27
7912	30
7914	30
7933	30
7935	30
7936	30
7937	30
7941	23
7942	23
7945	30
7946	30
7957	30
7958	30
9133/34D <sup>1</sup>	14
9133/34D Opt. 001 <sup>1</sup>	16
9133/34H <sup>1</sup>	19
9133/34H Opt. 001 <sup>1</sup>	22
9133/34L <sup>1</sup>	30
9133/34L Opt. 001 <sup>1</sup>	30
9153A <sup>1</sup>	9
9154A <sup>1</sup>	9

---

<sup>1</sup> If you set the configuration switch to partition the disc into multiple volumes, the number of volumes may vary.

---

# Installing HP 7911, 7912, and 7914 Disc/Tape Drives

---

## IMPORTANT!

These disc/tape drives will be installed by HP Customer Engineers. Installation cost is included in the purchase price of the unit.

---

### Description

These disc/tape drives are Command Set 80 (CS/80) devices.

### Support

The HP 7911P/R, HP 7912P/R, HP 7914CT and HP 7914P/R are supported on all Series 200 computers with boot ROM 3.0 or later, and on Series 300 computers with boot ROM Rev. A or later.

Operating/Language system support is as follows:

- **BASIC:** The HP 7911 and HP 7912 are supported on revision 2.0 or later with Series 200 computers, and are supported on revision 4.0 or later with Series 300 computers. The HP 7914 is supported on revision 3.0 or later with Series 200 computers, and is supported by revision 4.0 or later with Series 300 computers.
- **Pascal Workstation:** The HP 7911 and HP 7912 are supported on revision 2.0 or later with Series 200 computers, and are supported on revision 3.1 or later with Series 300 computers. The HP 7914 is supported on revision 3.0 or later with Series 200 computers, and is supported by revision 3.1 or later with Series 300 computers.
- **HP-UX Operating System:** supported on revision 2.0 or later with Series 200 computers; supported on revision 5.0 or later with Series 300 computers.

### Before You Begin

Your HP Customer Engineer will unpack and install your disc/tape drive for you. The following procedure describes how to connect your disc/tape drive to your Series 200/300 computer.



## Determining Flexible Disc Drive Unit Numbers

---

### NOTE

For Model 226 and 236 internal drive unit numbers, see the worksheet entries in the “Installing Model 226/236 Internal Disc Drives” section.

---

### If You Have Only One (Dual or Single) Flexible Disc Drive Unit

1. In the Unit Numbers column of the *left-hand* flexible disc drive (the only drive in single drive units), write **#3:**.
2. If you have a dual drive unit, in the Unit Numbers column of the *right-hand* flexible disc drive, write **#4:**.

### If You Have More Than One (Dual or Single) Flexible Disc Drive Unit

1. Look over your worksheet and identify all of your flexible disc drives. Decide which *one* of them you will initially use to boot the Pascal Workstation. That is, when you load the Pascal Workstation boot disc into your computer for the first time, which of these drives will you use? This drive is called the **boot device**.

---

### NOTE

If you choose one of the drives in a dual flexible disc drive unit (e.g., HP 9121, HP 9122) as your boot device, choose the *left-hand* disc drive.

---

2. In the Unit Numbers column for the boot device, write **#3:**. If the boot device is the left-hand drive in a dual flexible disc drive unit, write **#4:** in the Unit Numbers column for the right-hand drive in the unit.
3. Of your remaining flexible disc drive units, find the one connected to the interface with the *highest* select code. If more than one unit is connected to this select code, find the one that has the *highest* primary address.

For example, if unit 1 is connected to the interface at select code 7, and unit 2 is connected to the interface at select code 14, you would choose unit 2.

As another example, if unit 1 is connected to select code 7, unit 2 is connected to select code 14 at primary address 2, and unit 3 is connected to select code 14 at primary address 3, you would choose unit 3.

4. In the Unit Numbers column for the *left-hand* drive of this flexible disc drive unit (the only drive is a single flexible disc drive unit), write **#7:**. If you have a dual flexible disc drive unit, write **#8:** in the Unit Numbers column for the *right-hand* drive.
5. If you have another flexible disc drive unit, write **#9:** in the Unit Numbers column for the *left-hand* drive (the only drive if the unit contains a single flexible disc drive), and write **#10:** in the Unit Numbers column for the *right-hand* drive.

---

#### NOTE

The Pascal Workstation cannot access more than three separate flexible disc drive units without some modifications. If you have more than three separate units containing flexible disc drives, see the Special Configurations chapter of the *Pascal Workstation System* manual.

---

## Determining Hard Disc Drive Unit Numbers

### If You Have Only One Hard Disc

1. Look up the number of units into which the device is divided in Table 6-1. If the device does not appear in the table, calculate the number of units like this:
  - a. Round the storage capacity of the disc down to the nearest whole Mbyte.
  - b. The number in step a is the number of units into which the device is divided *if* this number is less than or equal to 30. If the number is greater than 30, then the device is divided into 30 units.
2. Starting at unit **#11:**, count off the number of units as determined in step 1. These are the unit numbers assigned to the device.

For example, if in step 1 you determined the device is divided into 14 units, then the device will be assigned unit numbers #11: thru #24:. If the device is divided into 30 units, then the device will be assigned unit numbers #11: thru #40:.

3. Write the range of unit numbers on the Unit Numbers line for the device. For example, you would write **#11: thru #24:** for the first example above, and **#11: thru #40:** in the second example. Be sure to include the # and :, as these symbols are part of the unit number.

### **If You Have Only One Hard Disc on Each Interface...**

1. Look on your worksheet and find the hard disc that is connected to the interface with the *highest* select code. For example, if hard disc 1 is connected to an interface with select code 7 and hard disc 2 is connected to an interface with select code 14, you would choose hard disc 2.
2. Look up the number of units into which the hard disc is divided in Table 6-1. If the hard disc does not appear in the table, calculate the number of units like this:
  - a. Round the storage capacity of the disc down to the nearest whole Mbyte.
  - b. The number in step a is the number of units into which the hard disc is divided *if* this number is less than or equal to 30. If the number is greater than 30, then the hard disc is divided into 30 units.
3. Starting at unit #11:, count off the number of units as determined in step 2. These are the unit numbers assigned to this hard disc.

For example, if in step 2 you determined the hard disc is divided into 14 units, then it will be assigned unit numbers #11: thru #24:. If the hard disc is divided into 30 units, then it will be assigned unit numbers #11: thru #40:.

4. Write the range of unit numbers on the Unit Numbers line for the hard disc. For example, you would write **#11: thru #24:** for the first example above, and **#11: thru #40:** for the second example. Be sure to include the # and : as these symbols are part of the unit number.

---

#### **NOTE**

If this first disc was assigned unit numbers #11: thru #40:, there are no unit numbers left for your remaining hard disc(s). See the Special Configurations chapter of the *Pascal Workstation System* manual for instructions.

---

5. Next, find the hard disc that is connected to the interface with the *next highest* select code.
6. Look up the number of units into which this hard disc is divided in Table 6-1. If the hard disc does not appear in the table, calculate the number of units as described in steps 2a-b.
7. Starting with the *next unused* unit number, count off the number of units as determined in step 6.
  - If you stopped counting at or before unit number #40:, these are the unit numbers assigned to the hard disc. Write them on your worksheet.
  - If you counted past unit #40:, you have run out of unit numbers. Only those unit numbers from #40: on down have been assigned to this hard disc, and part of the storage capacity of the hard disc is inaccessible. See the Special Configurations chapter of the *Pascal Workstation System* manual and the manual that came with the hard disc for instructions.

**Examples:** If your first hard disc received unit numbers #11: thru #24:, and your second hard disc is divided into 10 units, then this second hard disc will receive unit numbers #25: thru #34:.

If your first hard disc received unit numbers #11: thru #24:, and your second hard disc is divided into 20 units, then this second hard disc will receive unit numbers #25: thru #40:. In this case, 4 of the 20 units would not receive unit numbers, and the storage space allocated to these 4 units would not be accessible.

8. If you have not exceeded unit number #40:, repeat steps 5 through 7 for your remaining hard discs.

### **If You Have More Than One Hard Disc on An Interface...**

1. Look on your worksheet and find the highest select code containing a hard disc. For example, if hard disc 1 is connected to an interface with select code 7 and hard discs 2 and 3 are connected to an interface with select code 14, then the highest select code containing a hard disc is 14.
2. Find all hard discs on this highest select code (e.g., discs 2 and 3 in the example above).

3. Of the discs you found in step 2, select the one with the highest priority:
  - If this select code contains more than one hard disc (as in the example above), look on your worksheet and determine which hard disc has the *highest* primary address. This is the disc with the highest priority. For example, if disc 2 has primary address 0 and disc 3 has primary address 2, you would select disc 3.
  - If this select code contains only one hard disc, then select that disc and go on to step 4.
4. Look up the number of units into which this hard disc is divided in Table 6-1. If the hard disc does not appear in the table, calculate the number of units like this:
  - a. Round the storage capacity of the disc down to the nearest whole Mbyte.
  - b. The number in step a is the number of units into which the hard disc is divided *if* this number is less than or equal to 30. If the number is greater than 30, then the hard disc is divided into 30 units.
5. Starting at unit #11:, count off the number of units as determined in step 4. These are the unit numbers assigned to this hard disc.

For example, if in step 4 you determined the hard disc is divided into 14 units, then it will be assigned unit numbers #11: thru #24:. If the hard disc is divided into 30 units, then it will be assigned unit numbers #11: thru #40:.
6. Write the range of unit numbers on the Unit Numbers line for the hard disc. For example, you would write **#11: thru #24:** for the first example above, and **#11: thru #40:** for the second example. Be sure to include the # and : as these symbols are part of the unit number.

---

#### NOTE

If this first disc was assigned unit numbers #11: thru #40:, there are no unit numbers left for your remaining hard disc(s). See the Special Configurations chapter(of the *Pascal Workstation System* manual for instructions.

---

7. Select the next highest priority disc:
  - If there are additional hard discs on this same select code, select the hard disc with the *next highest* primary address.
  - If there are no other hard discs on this select code, select the hard disc on the next highest select code that has the highest primary address.
8. Look up the number of units into which this hard disc is divided in Table 6-1. If the hard disc does not appear in the table, calculate the number of units as described in steps 4a-b.
9. Starting with the *next unused* unit number, count off the number of units as determined in step 8.
  - If you stopped counting at or before unit #40:, these are the unit numbers assigned to the hard disc. Write them on your worksheet.
  - If you counted past unit #40:, you have run out of unit numbers. Only those unit numbers from #40: on down have been assigned to your hard disc, and part of the storage capacity of the hard disc is inaccessible. See the Special Configurations chapter of the *Pascal Workstation System* manual and the manual that came with the hard disc for instructions.

**Examples:** If your first hard disc received unit numbers #11: thru #24:, and your second hard disc is divided into 10 units, then this second hard disc will receive unit numbers #25: thru #34:.

If your first hard disc received unit numbers #11: thru #24:, and your second hard disc is divided into 20 units, then this second hard disc will receive unit numbers #25: thru #40:. In this case, 4 of the 20 units would not receive unit numbers, and the storage space allocated to these 4 units would not be accessible.
10. If you have not exceeded unit number #40:, repeat steps 7 through 9 for your remaining hard discs.

## Determining Tape Drive Unit Numbers

1. Look over your worksheet and identify all of your tape drives. Find the one connected to the interface with the *highest* select code. If more than one tape drive is connected to this select code, find the one that has the *highest* primary address.

For example, if tape drive 1 is connected to the interface at select code 7, and tape drive 2 is connected to the interface at select code 14, you would choose tape drive 2.

As another example, if tape drive 1 is connected to select code 14 at primary address 2, and tape drive 2 is connected to select code 14 at primary address 3, you would choose tape drive 2.

2. In the Unit Numbers column for this tape drive, write **#41**.
3. If you have another tape drive, write **#42** in its Unit Numbers column.

---

## Determining HP-UX Minor Numbers

If you **did not** use:

- An address of 0, 2 or 3 for your mass storage device, and/or
- The preset select code for your HP 98625 (preset select code 14) Disc Interface or HP 98624 HP-IB Interface (preset select code 8),

then the minor numbers given in the “HP-UX System Worksheet Entries” are incorrect.

To determine your correct minor number, follow this procedure:

1. Choose any worksheet entry table for your device as an example to work from.
2. **If Your Select Code Is Different:** The first two digits to the right of the 0x in the minor number indicate the select code of the interface the device is connected to. Change these two digits to *your* select code value (in hexadecimal). For example:
  - If your select code is 25, and the example minor number is 0x**07**0010, change the 07 to **19**, giving the new minor number 0x**19**0010. (Note: 19 is the hexadecimal value for 25).
  - If your select code is 10, and the example minor number is 0x**0e**0200, change the 0e to **0a**, giving the new minor number 0x**0a**0200. (Note: 0a is the hexadecimal value for 10).
3. **If Your Address Is Different:** The next two digits following the select code digits indicate the address of the device. Change these two digits to *your* address value (in hexadecimal). For example:
  - If your address is 5, and the example minor number is 0x**07****00**10, change the 00 to **05**, giving the new minor number 0x**07****05**10.
  - If your address is 7, and the example minor number is 0x**0e****02**00, change the 02 to **07**, giving the new minor number 0x**0e****07**00.
4. Change the minor number in each worksheet entry given for your device.





## HP 7911, 7912 and 7914 Installation Procedure

---

### CAUTION

Do not attempt to operate the unit until it is moved to the installation site and the spindle and actuator are unlocked. Do not apply any sudden mechanical shocks to the unit.

---

#### 1. Play It Safe.

- a. Make arrangements with your HP Customer Engineer to have your disc/tape drive unpacked and installed.
- b. Turn your computer and disc drive off, if they are not already off.

#### 2. Select Your Disc's Interface.

- a. Select one of the following interfaces, listed in order of preference for optimum disc performance:
  - HP 98625 Disc Interface
  - Built-in HP-IB Interface

#### 3. Select Your Tape's Interface. (Dual Controller Only).

---

### CAN YOU SKIP THIS STEP?

If you have dual controllers, continue with step 3; otherwise skip to step 4.

---

#### a. HP-UX Recommendations:

- If you selected an HP 98625 Disc Interface for your disc, use the built-in HP-IB Interface for your tape.
- If you selected the built-in HP-IB interface for your disc, use an HP 98624A HP-IB Interface for your tape (if available).
- Otherwise, use your built-in HP-IB interface for both disc and tape.

b. **BASIC and Pascal Workstation Recommendations:**

- Connect the tape drive to the HP 98625 Disc Interface or to the built-in HP-IB interface.

4. **Set the Disc Address.**

- a. On the back of the disc drive, find the set of three switches labeled “HP-IB DISC.”
- b. Set the HP-IB address:
  - If there is only *one* other disc or tape drive (besides this HP 7911/12/14) already connected to the interface, set the “HP-IB DISC” switches to 2 as shown below, unless address 2 has been used elsewhere.

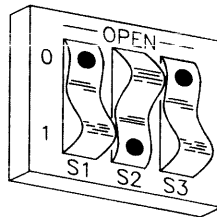

**Address 2**

- If there are *two* other disc or tape drives (besides this HP 7911/12/14) already connected to the interface, set the “HP-IB DISC switches to 3 as shown below, unless address 2 has been used elsewhere. Refer to the manual that came with your disc drive if you need additional switch settings.

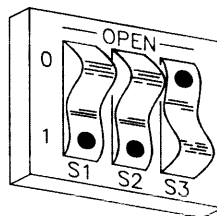

**Address 3**

## 5. Set the Tape Address (Dual Controller Only).

---

### CAN YOU SKIP THIS STEP?

If you do not have dual controllers, skip to step 6; otherwise continue with step 5.

---

- a. On the back of the disc drive, find the set of three switches labeled “HP-IB TAPE.”
- b. Set the HP-IB tape address, making sure that you do not set it to the same address used by the 7911/12/14 disc drive if both disc and tape share the same interface:
  - If this is the first (or only) disc or tape drive you are connecting to the interface, set the “HP-IB TAPE” switches to 0 as shown below, unless address 0 has been used elsewhere.

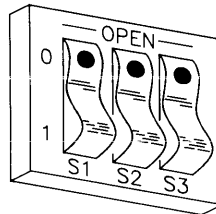

**Address 0**

- If there is only *one* other disc or tape drive (besides this HP 7911/12/14 tape) already connected to the interface, set the “HP-IB TAPE” switches to 2 as shown below, unless address 2 has been used elsewhere.

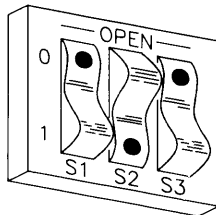

**Address 2**

- If there are *two* other disc or tape drives (besides this HP 7911/12/14 tape) already connected to the interface, set the “HP-IB TAPE” switches to 3 as shown below, unless address 3 has been used elsewhere. Refer to the manual that came with your disc/tape drive for additional switch settings.

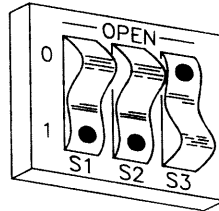

**Address 3**

**6. Connect the Disc to Your Computer.**

- a. Find the HP-IB cable provided with the disc/tape drive.
- b. Connect one end of the HP-IB cable to the HP-IB socket to the right of the “HP-IB DISC” address switches. Tighten the thumb screws to secure the connection.
- c. Connect the other end of the HP-IB cable to the interface.

---

**NOTE**

If the interface already has several cables connected to it, connect your HP 7911/12/14 cable to one of the other devices on the interface.

---

## 7. Connect the Tape to Your Computer (Dual Controller Only).

---

### CAN YOU SKIP THIS STEP?

If you do not have dual controllers, skip to step 8; otherwise, continue with step 7.

---

- a. Find the additional HP-IB cable provided with the disc/tape drive.
- b. Connect one end of the HP-IB cable to the HP-IB socket to the right of the “HP-IB TAPE” address switches. Tighten the thumb screws to secure the connection.
- c. Connect the other end of the HP-IB cable to the interface.

---

### NOTE

If the interface already has several cables connected to it, connect your HP 7911/12/14 cable to one of the other devices on the interface.

---

## 8. Connect the Power Cord.

- a. Connect the female end of the power cord to the “AC LINE” socket on the back of the disc drive, and connect the other end to your power outlet.
- b. Position the drive in its operating location and lower the leveling feet until the casters carry no weight. Ensure that there is at least three inches of clearance behind the drive.

## 9. Record the Address.

- a. Make a note that the address(es) used for your disc/tape drive are no longer available on the interface(es) you selected. Use the “Address Record” form on the Step 6 tab for this purpose.

---

## The Next Step

You have now installed your HP 7911/12/14 Disc/Tape Drive.

The following “Worksheet Entries” contain information needed to use your disc/tape drive with various language/operating systems. Refer to the entries for the system you’ll be using (BASIC, Pascal or HP-UX).

Copy this information to a worksheet (worksheets are found at the end of Step 1) or remember to refer here when you need it.

When finished, you’ll be ready to install your next peripheral.

---

## BASIC System Worksheet Entries

---

### NOTE

If you have a dual controller device, refer to the separate tape controller tables, at the end of this section, for your tape msvs.

---

#### Single-Controller HP 7911/12/14 Connected to HP 98625 Disc Interface (Select Code 14)

Device Name	Msvs <sup>1</sup>	Driver Name	Interleave Factor
HP 7911/12/14 - Disc	“:,140 $n$ ”	CS80	1
HP 7911/12/14 - Tape	“:,140 $n$ ,1”	CS80	1

#### Single-Controller HP 7911/12/14 Connected to Built-in HP-IB Interface (Select Code 7)

Device Name	Msvs <sup>1</sup>	Driver Name	Interleave Factor
HP 7911/12/14 - Disc	“:,70 $n$ ”	CS80	1
HP 7911/12/14 - Tape	“:,70 $n$ ,1”	CS80	1

---

<sup>1</sup>  $n$  is a number that identifies the address (set in step 4 of the Installation Procedure). Replace  $n$  with a 0 if the address was set to 0, use 2 if the address was set to 2, and so on.

---

## BASIC System Worksheet Entries (Cont.)

Separate Tape Controller Connected to HP 98625 Disc Interface (Select Code 14)

Device Name	Msvs <sup>1</sup>	Driver Name	Interleave Factor
HP 7911/12/14 - Tape	“:,140 $n$ ”	CS80	1

Separate Tape Controller Connected to Built-in HP-IB Interface (Select Code 7)

Device Name	Msvs <sup>1</sup>	Driver Name	Interleave Factor
HP 7911/12/14 - Tape	“:,70 $n$ ”	CS80	1

---

## Pascal Workstation Worksheet Entries

Device Name	Unit Numbers <sup>2</sup>	Module Name <sup>3</sup>	Interleave Factor
HP 7911 - Disc	#11: thru #37:	DISCHPIB & CS80	1
HP 7911 - Tape	#41:	DISCHPIB & CS80	1
HP 7912/14 - Disc	#11: thru #40:	DISCHPIB & CS80	1
HP 7912/14 - Tape	#41:	DISCHPIB & CS80	1

<sup>1</sup>  $n$  is a number that identifies the address (set in step 5 of the Installation Procedure). Replace  $n$  with a 0 if the address was set to 0, use 2 if the address was set to 2, and so on.

<sup>2</sup> If you have more than one hard disc drive, the unit number assignments for your HP 7911/12/14 may be different. Refer to the section, “Determining Pascal Unit Numbers,” found at the end of this chapter, after you have installed *all* of your discs.

<sup>3</sup> If you are using a high-speed disc interface, include the DISC\_INTF module. If your computer also includes DMA, you also need the DMA module.



---

# HP-UX System Worksheet Entries

---

## NOTE

If you have a dual controller device, refer to the separate tape controller tables for your tape minor number.

---

### HP 7911/12/14 Connected to HP 98625 Disc Interface (Select Code 14)

Device Name	Path <sup>1</sup> Name	File Type	Major Number	Minor <sup>2</sup> Number	Interleave Factor
HP 7911/12/14 - Disc	<i>/dev/dsk/#s0</i>	b	0	0x0e0n00	1
HP 7911/12/14 - Disc	<i>/dev/rdisk/#s0</i>	c	4	0x0e0n00	1
HP 7911/12/14 - Tape	<i>/dev/ct/#s0</i>	b	0	0x0e0n10	1
HP 7911/12/14 - Tape	<i>/dev/rct/#s0</i>	c	4	0x0e0n10	1

### HP 7911/12/14 Connected to Built-in HP-IB Interface (Select Code 7)

Device Name	Path <sup>1</sup> Name	File Type	Major Number	Minor <sup>2</sup> Number	Interleave Factor
HP 7911/12/14 - Disc	<i>/dev/dsk/#s0</i>	b	0	0x070n00	1
HP 7911/12/14 - Disc	<i>/dev/rdisk/#s0</i>	c	4	0x070n00	1
HP 7911/12/14 - Tape	<i>/dev/ct/#s0</i>	b	0	0x070n10	1
HP 7911/12/14 - Tape	<i>/dev/rct/#s0</i>	c	4	0x070n10	1

---

<sup>1</sup> Replace # with any unique number, and use the same number in both the */dev/dsk* and */dev/rdisk* entries (e.g., */dev/dsk/1s0* and */dev/rdisk/1s0*). Record the numbers on the Step 6 tab.

<sup>2</sup> *n* is a number that identifies the address (set in step 4 of the Installation Procedure). Replace *n* with a 0 if the address was set to 0, use 2 if the address was set to 2, and so on.

---

## HP-UX System Worksheet Entries (Cont.)

### Separate Tape Controller Connected to Built-in HP-IB Interface (Select Code 7)

Device Name	Path <sup>1</sup> Name	File Type	Major Number	Minor <sup>2</sup> Number	Interleave Factor
HP 7911/12/14 - Tape	<i>/dev/ct/#s0</i>	b	0	0x070n00	1
HP 7911/12/14 - Tape	<i>/dev/rct/#s0</i>	c	4	0x070n00	1

### Separate Tape Controller Connected to HP 98624 HP-IB Interface (Select Code 8)

Device Name	Path <sup>1</sup> Name	File Type	Major Number	Minor <sup>2</sup> Number	Interleave Factor
HP 7911/12/14 - Tape	<i>/dev/ct/s#0</i>	b	0	0x080n00	1
HP 7911/12/14 - Tape	<i>/dev/rct/#s0</i>	c	4	0x080n00	1

---

<sup>1</sup> # is a number that identifies the tape drive. Replace # with any unique number, and use the same number in both the */dev/ct* and */dev/rct* entries (e.g., */dev/ct/1s0* and */dev/rct/1s0*). Record the numbers on the Step 6 tab.

<sup>2</sup> n is a number that identifies the address (set in step 5 of the Installation Procedure). Replace n with a 0 if the address was set to 0, use 2 if the address was set to 2, and so on.

---

# Installing the HP 7933 and 7935 Disc Drives

---

## IMPORTANT!

These disc/tape units are to be installed by HP Customer Engineers. The installation cost is included in the purchase price of the unit.

---

### Description

These disc drives are Command Set 80 (CS/80) devices.

### Support

The HP 7933 and HP 7935 are supported on Series 200 Model 220, 226, 236 and 237 computers with boot ROM 3.0 or later, and on all Series 300 computers with boot ROM Rev. A or later.

Operating/Language system support is as follows:

- **BASIC:** Not supported.
- **Pascal Workstation:** supported on revision 3.0 or later with Series 200 computers; supported on revision 3.1 or later with Series 300 computers.
- **HP-UX Operating System:** supported on revision 2.0 or later with Series 200 computers; supported on revision 5.0 or later with Series 300 computers.

### Before You Begin

Your HP Customer Engineer will unpack and install your disc drive for you. The following procedure describes how to connect your disc drive to your Series 200/300 computer.

## HP 7933 and 7935 Installation Procedure

---

### CAUTION

Do not attempt to operate the unit until it is moved to the installation site and the spindle and actuator are unlocked.

Do not apply any sudden mechanical shocks to the unit.

---

#### 1. Play It Safe.

- a. Make arrangements with your HP Customer Engineer to have your disc drive unpacked and installed.
- b. Turn your computer and disc drive off, if they are not already off.

#### 2. Select Your Interface.

- a. Select one of the following interfaces, listed in order of preference for optimum disc performance:
  - HP 98625 Disc Interface
  - Built-in HP-IB Interface

### 3. Set the Address.

- a. On the back of the disc drive, find the set of three switches labeled “HP-IB PRIMARY PORT.”
- b. Set the HP-IB address:
  - If there is only *one* other disc or tape drive (besides this HP 7933/35) already connected to the interface, set the “HP-IB PRIMARY PORT” switches to 2 as shown below, unless address 2 has been used elsewhere.

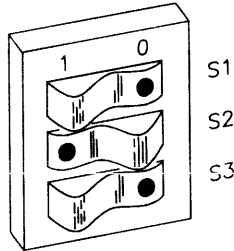

**Address 2**

- If there are *two* other disc or tape drives (besides this HP 7933/35) already connected to the interface, set the “HP-IB PRIMARY PORT” switches on your HP 7933/35 to 3 like this:

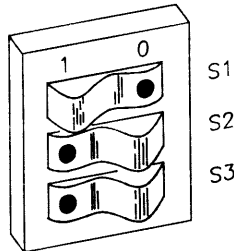

**Address 3**

#### 4. **Connect the Disc to Your Computer.**

- a. Find the HP-IB cable provided with the disc drive.
- b. Connect one end of the HP-IB cable to the HP-IB socket on the back of the disc drive. Tighten the thumb screws to secure the connection.
- c. Connect the other end of the HP-IB cable to the interface.

---

#### **NOTE**

If the interface already has several cables connected to it, connect your HP 7933/35 cable to one of the other devices on the interface.

---

#### 5. **Connect the Power Cord.**

- a. Connect the female end of the power cord to the power socket on the back of the disc drive, and connect the other end to your power outlet.

#### 6. **Record the Address.**

- a. Make a note that address 0 (or the alternate address you chose in step 3) has been used and is no longer available on the interface you selected. Use the “Address Record” form on the Step 6 tab for this purpose.

---

## **The Next Step**

You have now installed your HP 7933/35 Disc Drive.

The following “Worksheet Entries” contain information needed to use your disc drive with various language/operating systems. Refer to the entries for the system you’ll be using (Pascal or HP-UX).

Copy this information to a worksheet (worksheets are found at the end of Step 1) or remember to refer here when you need it.

When finished, you’ll be ready to install your next peripheral.

---

## Pascal Workstation Worksheet Entries

Device Name	Unit Numbers <sup>1</sup>	Module Name <sup>2</sup>	Interleave Factor
HP 7933/35	#11: thru #40:	DISCHPIB & CS80	1

---

## HP-UX System Worksheet Entries

### HP 7933/35 Connected to HP 98625 Disc Interface (Select Code 14)

Device Name	Path <sup>3</sup> Name	File Type	Major Number	Minor <sup>4</sup> Number	Interleave Factor
HP 7933/35	<i>/dev/dsk/#s0</i>	b	0	0x0e0n00	1
HP 7933/35	<i>/dev/rdisk/#s0</i>	c	4	0x0e0n00	1

### HP 7933/35 Connected to Built-in HP-IB Interface (Select Code 7)

Device Name	Path <sup>3</sup> Name	File Type	Major Number	Minor <sup>4</sup> Number	Interleave Factor
HP 7933/35	<i>/dev/dsk/#s0</i>	b	0	0x070n00	1
HP 7933/35	<i>/dev/rdisk/#s0</i>	c	4	0x070n00	1

<sup>1</sup> If you have more than one hard disc drive, the unit number assignments for your HP 7933/35 may be different. Refer to the section, "Determining Pascal Unit Numbers," found at the end of this chapter, after you have installed *all* of your discs.

<sup>2</sup> If you are using a high-speed disc interface, include the DISC\_INTF module. If your computer also includes DMA, you also need the DMA module.

<sup>3</sup> # is a number that identifies the disc drive (e.g., 0 for the root disc, 1 for the next disc installed, etc.). Replace # with any unique number, and use the same number in both the */dev/dsk* and */dev/rdisk* entries (e.g., */dev/dsk/1s0* and */dev/rdisk/1s0*). Record the numbers on the Step 6 tab.

<sup>4</sup> n is a number that identifies the address (set in step 3 of the Installation Procedure). Replace n with a 0 if the address was set to 0, use 2 if the address was set to 2, and so on.

---

# Installing the HP 7936H and 7937H Disc Drives

---

## IMPORTANT!

These HP 7936H and 7937H disc drives are to be installed by an HP Customer Engineer. The installation cost is included in the purchase price of the unit.

---

### Description

These disc drives are Command Set (CS/80) devices.

### Support

The HP 7936H and 7937H are supported on all Series 300 computers with boot ROM Rev. A or later.

Operating/Language system support is as follows:

- **BASIC:** supported on revision 4.0 or later with Series 300 computers.
- **Pascal Workstation:** supported on revision 3.1 or later with Series 300 computers.
- **HP-UX Operating System:** supported on revision 5.1 or later with Series 300 computers.

### Before You Begin

Your HP Customer Engineer will unpack and install your disc drive for you. The following procedure describes how to connect your disc drive to your Series 300 computer.



## HP 7936H and 7937H Installation Procedure

---

### CAUTION

Do not attempt to operate the unit until it is moved to the installation site and the spindle and actuator are unlocked.

Do not apply any sudden mechanical shocks to the unit.

---

#### 1. Play It Safe.

- a. Make arrangements with your HP Customer Engineer to have your disc drive unpacked and installed.
- b. Turn your computer and disc drive off, if they are not already off.

#### 2. Select Your Interface.

- a. The HP 7936H and 7937H disc drives are supported only on a high-speed HP-IB interface such as the HP 98625A/B Disc Interface.

#### 3. Set the Address.

- a. On the back of the disc drive, find the set of four switches in the upper left-hand corner.
- b. Set the HP-IB address:
  - If this is the first or only disc or tape drive connected to the interface, set the switches to 0 as shown below.

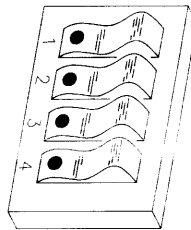

**Address 0**

- If there is only *one* other disc or tape drive (besides this HP 7936H or 7937H) already connected to the interface, set the switches to 2 as shown below, unless address 2 has been used elsewhere.

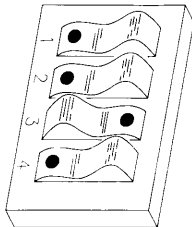

**Address 2**

- If there are *two* other disc or tape drives (besides this HP 7936H or 7937H) already connected to the interface, set the switches to 3 as shown below, unless address 3 has been used elsewhere.

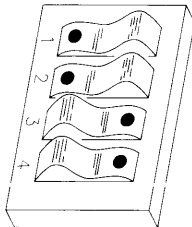

**Address 3**

#### 4. Connect the Disc Drive Your Computer.

- a. Find the HP-IB cable provided with the disc drive.
- b. Connect one end of the HP-IB cable to the HP-IB socket on the back of the disc drive. Tighten the thumb screws to secure the connection.
- c. Connect the other end of the HP-IB cable to the interface.

---

#### **NOTE**

If the interface already has several cables connected to it, connect your HP 7936H or 7937H cable to one of the other devices on the interface.

---

**5. Connect the Power Cord.**

- a. Connect the female end of the power cord to the power socket on the back of the disc drive, and connect the other end to your power outlet.

**6. Record the Address.**

- a. Make a note that address 0 (or the alternate address you chose in step 3) has been used and is no longer available on the interface you selected. Use the “Address Record” form on the Step 6 tab for this purpose.

---

## **The Next Step**

You have now installed you HP 7936H or 7937H Disc Drive.

The following “Worksheet Entries” contain information needed to use your disc drive with various language/operating systems. Refer to the entries for the system you’ll be using.

Copy this information to a worksheet (Worksheets are found at the end of Step 1) or remember to refer here when you need it.

When finished, you’ll be ready to install your next peripheral.

---

## BASIC System Worksheet Entries

HP 7936/37H Connected to HP 98625 Disc Interface

Device Name	Msvs <sup>1</sup>	Driver Name	Interleave Factor
HP 7936/37H	“,140n”	CS80	1

---

## Pascal Workstation Worksheet Entries

Device Name	Unit Numbers <sup>2</sup>	Module Name <sup>3</sup>	Interleave Factor
HP 7937/37H	#11: thru #40:	DISCHPIB & CS80	1

---

## HP-UX System Worksheet Entries

HP 7936/37H Connected to HP 98625 Disc Interface (Select Code 14)

Device Name	Path <sup>4</sup> Name	File Type	Major Number	Minor <sup>1</sup> Number	Interleave Factor
HP 7936/37H	/dev/dsk/#s0	b	0	0x0e0n00	1
HP 7936/37H	/dev/rdisk/#s0	c	4	0x0e0n00	1

<sup>1</sup> n is number that identifies the address (set in step 3 of the Installation Procedure). Replace n with a 1 if the address was set to 1, use 4 if the address was set to 4, and so on.

<sup>2</sup> If you have more than one hard disc drive, the unit number assignments for your HP 7936H/7937H may be different. Refer to the section, “Determining Pascal Unit Numbers,” found at the end of this chapter, after you have installed *all* of your discs.

<sup>3</sup> If you are using a high-speed disc interface, include the DISC\_INTF module. If your computer also includes DMA, you also need the DMA module.

<sup>4</sup> # is a number that identifies the disc drive (e.g. 0 for the root, for the next disc installed, etc.). Replace # with any unique number, and use the same number in both the /dev/dsk and /dev/rdisk entries (e.g. /dev/dsk/1s0 and /dev/rdisk/1s0). Record the numbers on the Step 6 tab.

---

# Installing the HP 7941, 7942, 7945 and 7946 Disc and Disc/Tape Drives

## Description

The HP 7941 and HP 7945 are Command Set 80 (CS/80) discs. The HP 7942 and HP 7946 contain a cartridge tape drive in addition to the disc drive.

## Support

The HP 7941, 7942, 7945 and 7946 are supported on all Series 200 computers with boot ROM 3.0 or later, and on all Series 300 computers with boot ROM Rev. A or later.

Operating/Language system support is as follows:

- **BASIC:** supported on revision 3.0 or later with Series 200 computers; supported on revision 4.0 or later with Series 300 computers.
- **Pascal Workstation:** supported on revision 3.0 or later with Series 200 computers; supported on revision 3.1 or later with Series 300 computers.
- **HP-UX Operating System:** the HP 7941 and HP 7945 are supported on revision 2.0 or later with Series 200 computers; supported on revision 5.0 or later with Series 300 computers. The HP 7942 and HP 7946 are supported on revision 2.1 or later with Series 200 computers; supported on revision 5.0 or later with Series 300 computers.

## Before You Begin

The following procedure describes how to connect your HP 7941, 7942, 7945 and 7946 to your Series 200/300 computer. Before you do this, however, refer to the manual(s) that came with the drive to:

- Unpack the drive.
- Check the voltage selector switch.
- Check the fuse value.

## HP 7941, 7942, 7945 and 7946 Installation Procedure

### 1. Play It Safe.

- a. Turn your computer and disc drive off, if they are not already off.

### 2. Select Your Interface.

- a. Select one of the following interfaces, listed in order of preference for optimum disc performance:

- HP 98625 Disc Interface
- Built-in HP-IB Interface

### 3. Set the Address.

- a. On the back of the disc drive, find the set of four switches labeled “ADDRESS.”
- b. Set the HP-IB address:
  - If there is only *one* other disc or tape drive (besides this HP 7941/42/45/46) already connected to the interface, set the “ADDRESS” switches to 2 as shown below, unless address 2 has been used elsewhere.

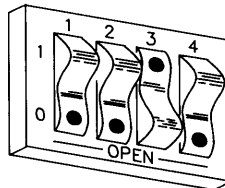

**Address 2**

- If there are *two* other disc or tape drives (besides this HP 7941/42/45/46) already connected to the interface, set the “ADDRESS” switches to 3 as shown below, unless address 3 has been used elsewhere.

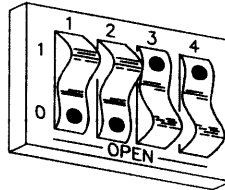

**Address 3**

**4. Connect the Disc Drive to Your Computer.**

- Find the HP-IB cable provided with the disc drive.
- Connect one end of the HP-IB cable to the HP-IB socket on the back of the disc drive. Tighten the thumb screws to secure the connection.
- Connect the other end of the HP-IB cable to the interface.

---

**NOTE**

If the interface already has several cables connected to it, connect your HP 7941/42/45/46 cable to one of the other devices on the interface.

---

**5. Connect the Power Cord.**

- Connect the female end of the power cord to the power socket on the back of the disc drive, and connect the other end to your power outlet.

**6. Record the Address.**

- Make a note that address 0 (or the alternate address you chose in step 3) has been used and is no longer available on the interface you selected. Use the “Address Record” form on the Step 6 tab for this purpose.

---

## The Next Step

You have now installed your HP 7941/42/45/46 Disc Drive.

The following “Worksheet Entries” contain information needed to use your disc drive with various language/operating systems. Refer to the entries for the system you’ll be using (BASIC, Pascal or HP-UX).

Copy this information to a worksheet (worksheets are found at the end of Step 1) or remember to refer here when you need it.

When finished, you’ll be ready to install your next peripheral.

---

## BASIC System Worksheet Entries

### HP 7941/42/45/46 Connected to HP 98625 Disc Interface (Select Code 14)

Device Name	Msvs <sup>1</sup>	Driver Name	Interleave Factor
HP 7941/42/45/46 - Disc	“:,140 $n$ ”	CS80	1
HP 7942/46 - Tape	“:,140 $n$ ,1”	CS80	1

### HP 7941/42/45/46 Connected to Built-in HP-IB Interface (Select Code 7)

Device Name	Msvs <sup>1</sup>	Driver Name	Interleave Factor
HP 7941/42/45/46 - Disc	“:,70 $n$ ”	CS80	1
HP 7942/46 - Tape	“:,70 $n$ ,1”	CS80	1

---

<sup>1</sup>  $n$  is a number that identifies the address (set in step 3 of the Installation Procedure). Replace  $n$  with a 0 if the address was set to 0, use 2 if the address was set to 2, and so on.



## Pascal Workstation Worksheet Entries

Device Name	Unit Numbers <sup>1</sup>	Module Name <sup>2</sup>	Interleave Factor
HP 7941/42 - Disc	#11: thru #33:	DISCHPIB & CS80	1
HP 7945/46 - Disc	#11: thru #40:	DISCHPIB & CS80	1
HP 7942/46 - Tape	#41:	DISCHPIB & CS80	1

## HP-UX System Worksheet Entries

HP 7941/42/45/46 Connected to HP 98625 Disc Interface (Select Code 14)

Device Name	Path <sup>3</sup> Name	File Type	Major Number	Minor <sup>4</sup> Number	Interleave Factor
HP 7941/42/45/46 - Disc	<i>/dev/dsk/#s0</i>	b	0	0x0e0n00	1
HP 7941/42/45/46 - Disc	<i>/dev/rdisk/#s0</i>	c	4	0x0e0n00	1
HP 7942/46 - Tape	<i>/dev/ct/#s0</i>	b	0	0x0e0n10	1
HP 7942/46 - Tape	<i>/dev/rct/#s0</i>	c	4	0x0e0n10	1

HP 7941/42/45/46 Connected to Built-in HP-IB Interface (Select Code 7)

Device Name	Path <sup>3</sup> Name	File Type	Major Number	Minor <sup>4</sup> Number	Interleave Factor
HP 7941/42/45/46 - Disc	<i>/dev/dsk/#s0</i>	b	0	0x070n00	1
HP 7941/42/45/46 - Disc	<i>/dev/rdisk/#s0</i>	c	4	0x070n00	1
HP 7942/46 - Tape	<i>/dev/ct/#s0</i>	b	0	0x070n10	1
HP 7942/46 - Tape	<i>/dev/rct/#s0</i>	c	4	0x070n10	1

- <sup>1</sup> If you have more than one hard disc drive, the unit number assignments for your HP 7941/42/45/46 may be different. If you have more than one tape drive, the unit number assignment for your HP 7942/46 tape drive may be different. Refer to the section, "Determining Pascal Unit Numbers," found at the end of this chapter, after you have installed all of your disc and tape drives.
- <sup>2</sup> If you are using a high-speed disc interface, include the DISC\_INTF module. If your computer also includes DMA, you also need the DMA module.
- <sup>3</sup> # is a number that identifies the disc drive (e.g., 0 for the root disc, 1 for the next disc installed, etc.). Replace # with any unique number, and use the same number in both the */dev/dsk* and */dev/rdisk* entries (e.g., */dev/dsk/1s0* and */dev/rdisk/1s0*). Record the numbers on the Step 6 tab.
- <sup>4</sup> n is a number that identifies the address (set in step 3 of the Installation Procedure). Replace n with a 0 if the address was set to 0, use 2 if the address was set to 2, and so on.

---

# Installing the HP 7957A and 7958A Disc Drives

## Description

These disc drives are Command Set (CS/80) devices.

## Support

The HP 7957A and 7958A are supported on Series 200 Model 226 and 236 computers with boot ROM 3.0 or later, and on all Series 300 computers with boot ROM Rev. A or later.

Operating/Language system support is as follows:

- **BASIC:** supported on revision 5.0 or later with both Series 200 and Series 300 computers.
- **Pascal Workstation:** Not supported on Series 200 computers; supported on revision 3.2 or later with Series 300 computers.
- **HP-UX Operating System:** Supported on revision 5.1 or later with both Series 200 and Series 300 computers.

## Before You Begin

The following procedure describes how to connect your HP 7957A and 7958A to your Series 200/300 computer. Before you do this however, refer to the manual(s) the came with the drive to:

- Unpack the drive.
- Check the voltage selector switch.
- Check the fuse value.

## HP 7957A and 7958A Installation Procedure

### 1. Play It Safe.

- a. Turn your computer and disc drive off, if they are not already off.

### 2. Select Your Interface.

- a. Select one of the following interfaces, listed in order of preference for optimum disc performance:
  - HP 98625 Disc Interface
  - Built-in HP-IB Interface

### 3. Set the Address.

- a. On the back of the 7957A/7958A disc drive, find the address wheel labeled “ADDRESS” in the upper left corner.
- b. Set the HP-IB address:
  - If this is the first disc or tape drive you are installing on the interface, set the address wheel to 0, unless address 0 has been used elsewhere.
  - If there is only *one* other disc or tape drive (besides this 7957A/7958A) already connected to the interface, set the address wheel to 2, unless address 2 has been used elsewhere.
  - If there are *two* other disc or tape drives (besides this 7957A/7958A) already connected to the interface, set the address wheel to 3, unless address 3 has been used elsewhere. If it has, choose any unused address.

### 4. Connect the Disc Drive to Your Computer.

- a. Find the HP-IB cable provided with the disc drive.
- b. Connect one end of the HP-IB cable to the HP-IB socket on the back of the disc drive. Tighten the thumb screws to secure the connection.
- c. Connect the other end of the HP-IB cable to the interface.

---

#### NOTE

If the interface already has several cables connected to it, connect your 7957A/7958A cable to one of the other devices on the interface.

---

## 5. Connect the Power Cord.

- a. Connect the female end of the power cord to the power socket on the back of the disc drive, and connect the other end to your power outlet.

## 6. Record the Address.

- a. Make a note that address 0 (or the alternate address you chose in step 3) has been used and is no longer available on the interface you selected. Use the “Address Record” form on the Step 6 tab for this purpose.

---

## The Next Step

You have now installed your 7957A/7958A Disc Drive.

The following “Worksheet Entries” contain information needed to use your disc drive with various language/operating systems. Refer to the entries for the system you’ll be using (BASIC, Pascal or HP-UX).

Copy this information to a worksheet (worksheets are found at the end of Step 1) or remember to refer here when you need it.

When finished, you’ll be ready to install your next peripheral.

---

## BASIC System Worksheet Entries

### HP 7957A/7958A Connected to HP 98625 Disc Interface (Select Code 14)

Device Name	Msvs <sup>1</sup>	Driver Name	Interleave Factor
HP 7957A/7958A	“:,140 $n$ ”	CS80	1

### HP 7957A/7958A Connected to Built-In HP-IB Interface (Select Code 7)

Device Name	Msvs <sup>1</sup>	Driver Name	Interleave Factor
HP 7957A/7958A	“:,70 $n$ ”	CS80	1

<sup>1</sup>  $n$  is a number that identifies the address (set in step 3 of the Installation Procedure). Replace  $n$  with a 1 if the address was set to 1, use 4 if the address was set to 4, and so on.

---

## Pascal Workstation Worksheet Entries

Device Name	Unit <sup>1</sup> Numbers	Module <sup>2</sup> Name	Interleave Factor
HP 7957A/7958A	#11: thru #40:	DISCHPIB & CS80	1

---

## HP-UX System Worksheet Entries

HP7957A/7958A Connected to HP 98625 Disc Interface (Select Code 14)

Device Name	Path <sup>3</sup> Name	File Type	Major Number	Minor <sup>4</sup> Number	Interleave Factor
HP 7957A/7958A	/dev/dsk/#s0	b	0	0x0e0n00	1
HP 7957A/7958A	/dev/rdisk/#s0	c	4	0x0e0n00	1

HP 7957A/7958A Connected to Built-in HP-IB Interface (Select Code 7)

Device Name	Path <sup>3</sup> Name	File Type	Major Number	Minor <sup>4</sup> Number	Interleave Factor
HP 7957A/7958A	/dev/dsk/#s0	b	0	0x070n00	1
HP 7957A/7958A	/dev/rdisk/#s0	c	4	0x070n00	1

<sup>1</sup> If you have more than one hard disc drive, the unit number assignments for your HP 7957A/7958A may be different. Refer to the section, "Determining Pascal Unit Numbers," found at the end of this chapter, after you have installed *all* of your discs.

<sup>2</sup> If you are using a high-speed disc interface, include the DISC\_INTF module. If your computer also includes DMA, you also need the DMA module.

<sup>3</sup> # is a number that identifies the disc drive (e.g. 0 for the root, 1 for the next disc intalled, etc.). Replace # with any unique number, and use the same number in both the /dev/dsk and /dev/rdisk entries (e.g. /dev/dsk/1s0 and /dev/rdisk/1s0). Record the numbers on the Step 6 tab.

<sup>4</sup> n is a number that identifies the address (set in step 3 of the Installation Procedure). Replace n with a 1 if the address was set to 1, use 4 if the address was set to 4, and so on.

---

# Installing the HP 7971A Tape Drive

---

## IMPORTANT!

The HP 7971A Tape Drive is to be installed by an HP Customer Engineer. The installation cost is included in the purchase price of the unit.

---

### Description

The HP 7971A is a 45 ips 1/2-inch 9-track open-reel tape drive supplied in an upright cabinet. It supports 1600 cpi Phase Encoded (PE) format. The HP 7971A operates in start/stop mode.

### Support

The HP 7971A is supported on Series 200 Model 220, 226, 236 and 237 computers.

Operating/Language system support is as follows:

- **BASIC:** not supported.
- **Pascal Workstation:** not supported.
- **HP-UX Operating System:** supported on revision 2.0 or later with Series 200 computers.

### Before You Begin

Your HP Customer Engineer will unpack and install your tape drive for you. The following procedure describes how to connect your tape drive to your Series 200 computer.

## HP 7971A Tape Drive Installation Procedure

---

### CAUTION

Do not attempt to operate the unit until your HP Customer Engineer has installed the unit for you.

---

#### 1. Play It Safe.

- a. Make arrangements with your HP Customer Engineer to have your tape drive installed.
- b. Turn your computer and tape drive off, if they are not already off.

#### 2. Select Your Interface.

- a. Use either the built-in HP-IB interface or an HP 98624 HP-IB Interface.

#### 3. Set the Address.

- a. On the back of the 7971A tape drive, find the address wheel located to the right of the HP-IB connector.
- b. Set the HP-IB address:
  - If this is the first disc or tape drive you are installing on the interface, set the address wheel to 0, unless address 0 has been used elsewhere.
  - If there is only *one* other disc or tape drive (besides this HP 7971A) already connected to the interface, set the address wheel to 2, unless address 2 has been used elsewhere.
  - If there are *two* other disc or tape drives (besides this HP 7971A) already connected to the interface, set the address wheel to 3, unless address 3 has been used elsewhere. If it has, choose any unused address.

#### 4. **Connect the Tape Drive to Your Computer.**

- a. Find the HP-IB cable provided with the tape drive.
- b. Connect one end of the HP-IB cable to the HP-IB socket on the back of the tape drive. Tighten the thumb screws to secure the connection.
- c. Connect the other end of the HP-IB cable to the interface.

---

#### **NOTE**

If the interface already has several cables connected to it, connect your HP 7971A cable to one of the other devices on the interface.

---

#### 5. **Connect the Power Cord.**

- a. Connect the female end of the power cord to the power socket on the back of the tape drive, and connect the other end to your power outlet.

#### 6. **Record the Address.**

- a. Make a note that address 0 (or the alternate address you chose in step 3) has been used and is no longer available on the interface you selected. Use the “Address Record” form on the Step 6 tab for this purpose.

---

## **The Next Step**

You have now installed your HP 7971A Tape Drive.

The following “Worksheet Entries” contain information needed to use your tape drive with HP-UX.

Copy this information to a worksheet (worksheets are found at the end of Step 1) or remember to refer here when you need it.

When finished, you'll be ready to install your next peripheral.



---

## HP-UX System Worksheet Entries

### HP 7971A Connected to Built-IN HP-IB Interface (Select Code 7)

Device Name	Path <sup>1</sup> Name	File Type	Major Number	Minor <sup>2</sup> Number
HP 7971A, Berkeley, no rewind	<i>/dev/rmt/#s0</i>	c	5	0x070n43
HP 7971A, Berkeley, autorewind	<i>/dev/rmt/#s0</i>	c	5	0x070n42
HP 7971A, AT&T, no rewind	<i>/dev/rmt/#s0</i>	c	5	0x070n41
HP 7971A, AT&T, autorewind	<i>/dev/rmt/#s0</i>	c	5	0x070n40

### HP 7971A Connected to HP 98624 HP-IB Interface (Select Code 8)

Device Name	Path <sup>1</sup> Name	File Type	Major Number	Minor <sup>2</sup> Number
HP 7971A, Berkeley, no rewind	<i>/dev/rmt/#s0</i>	c	5	0x080n43
HP 7971A, Berkeley, autorewind	<i>/dev/rmt/#s0</i>	c	5	0x080n42
HP 7971A, AT&T, no rewind	<i>/dev/rmt/#s0</i>	c	5	0x080n41
HP 7971A, AT&T, autorewind	<i>/dev/rmt/#s0</i>	c	5	0x080n40

---

<sup>1</sup> # is a number that identifies the magnetic tape drive. Replace # with any unique number (e.g., */dev/rmt/0s0* for the first mag tape). Record the numbers on the Step 6 tab.

<sup>2</sup> n is a number that identifies the address (set in step 3 of the Installation Procedure). Replace n with a 0 if the address was set to 0, use 2 if the address was set to 2, and so on.

---

# Installing the HP 7974A Tape Drive

---

## IMPORTANT!

The HP 7974A Tape Drive is to be installed by an HP Customer Engineer. The installation cost is included in the purchase price of the unit.

---

### Description

The HP 7974A is a 100/50 ips 1/2-inch 9-track open-reel tape drive supplied in an upright cabinet. It supports 1600 cpi Phase Encoded (PE) format and optionally 800 cpi NRZI format. The HP 7974A operates in either start/stop (50 ips) or streaming (100 ips) mode depending on whether data is available on the bus.

### Support

The HP 7974A is supported on Series 200 Model 217, 220, 226, 236 and 237 computers and on all Series 300 computers.

Operating/Language system support is as follows:

- **BASIC:** not supported.
- **Pascal Workstation:** not supported.
- **HP-UX Operating System:** supported on revision 5.1 or later with Series 200 computers; supported on revision 5.0 or later with Series 300 computers.

### Before You Begin

Your HP Customer Engineer will unpack and install your tape drive for you. The following procedure describes how to connect your tape drive to your Series 200/300 computer.

## HP 7974A Tape Drive Installation Procedure

---

### CAUTION

Do not attempt to operate the unit until your HP Customer Engineer has installed the unit for you.

---

#### 1. Play It Safe.

- a. Make arrangements with your HP Customer Engineer to have your tape drive installed.
- b. Turn your computer off, if it is not already off.
- c. Turn your HP 7974A Tape Drive on.

#### 2. Select Your Interface.

- a. Select one of the following interfaces, listed in order of preference for optimum tape performance:
  - HP 98625 Disc Interface
  - Built-in HP-IB Interface

### 3. Set the Address.

- a. Press the OFFLINE RESET button until the ONLINE indicator light turns off.
- b. Press the ADDRESS button to display the current address.
- c. Set the address:
  - If the HP 7974A is the first disc or tape drive you are connecting to the interface, press the UNITS button until **0** appears in the display, unless address 0 has been used elsewhere.
  - If there is only *one* other disc or tape drive (besides this HP 7974A) already connected to the interface, press the UNITS button until **2** appears in the display, unless address 2 has been used elsewhere.
  - If there are *two* other disc or tape drives (besides this HP 7974A) already connected to the interface, press the UNITS button until **3** appears in the display, unless address 3 has been used elsewhere. If it has, choose any unused address.
- d. Press the Enter button to assign the new address.
- e. Press the ADDRESS button to exit the address select mode.

### 4. Connect the Tape Drive to Your Computer.

- a. Find the HP-IB cable provided with the tape drive.
- b. Connect one end of the HP-IB cable to the HP-IB socket on the inside of the cabinet at the top. Tighten the thumb screws to secure the connection.
- c. Connect the other end of the HP-IB cable to the interface.

---

#### NOTE

If the interface already has several cables connected to it, connect your HP 7974A cable to one of the other devices on the interface.

---

## 5. Record the Address.

- a. Make a note that address 0 (or the alternate address you chose in step 3) has been used and is no longer available on the interface you selected. Use the “Address Record” form on the Step 6 tab for this purpose.

---

## The Next Step

You have now installed your HP 7974A Tape Drive.

The following “Worksheet Entries” contain information needed to use your tape drive with HP-UX.

Copy this information to a worksheet (worksheets are found at the end of Step 1) or remember to refer here when you need it.

When finished, you’ll be ready to install your next peripheral.

---

# HP-UX System Worksheet Entries

## HP 7974A Connected to HP 98625 Disc Interface (Select Code 14)

Device Name	Path <sup>1</sup> Name	File Type	Major Number	Minor <sup>2</sup> Number
HP 7974A, 800 cpi, Berkeley, no rewind	/dev/rmt/#s0	c	9	0x0e0n03
HP 7974A, 800 cpi, Berkeley, autorewind	/dev/rmt/#s0	c	9	0x0e0n02
HP 7974A, 800 cpi, AT&T, no rewind	/dev/rmt/#s0	c	9	0x0e0n01
HP 7974A, 800 cpi, AT&T, autorewind	/dev/rmt/#s0	c	9	0x0e0n00
HP 7974A, 1600 cpi, Berkeley, no rewind	/dev/rmt/#s0	c	9	0x0e0n43
HP 7974A, 1600 cpi, Berkeley, autorewind	/dev/rmt/#s0	c	9	0x0e0n42
HP 7974A, 1600 cpi, AT&T, no rewind	/dev/rmt/#s0	c	9	0x0e0n41
HP 7974A, 1600 cpi, AT&T, autorewind	/dev/rmt/#s0	c	9	0x0e0n40

## HP 7974A Connected to Built-in HP-IB Interface (Select Code 7)

Device Name	Path <sup>1</sup> Name	File Type	Major Number	Minor <sup>2</sup> Number
HP 7974A, 800 cpi, Berkeley, no rewind	/dev/rmt/#s0	c	9	0x070n03
HP 7974A, 800 cpi, Berkeley, autorewind	/dev/rmt/#s0	c	9	0x070n02
HP 7974A, 800 cpi, AT&T, no rewind	/dev/rmt/#s0	c	9	0x070n01
HP 7974A, 800 cpi, AT&T, autorewind	/dev/rmt/#s0	c	9	0x070n00
HP 7974A, 1600 cpi, Berkeley, no rewind	/dev/rmt/#s0	c	9	0x070n43
HP 7974A, 1600 cpi, Berkeley, autorewind	/dev/rmt/#s0	c	9	0x070n42
HP 7974A, 1600 cpi, AT&T, no rewind	/dev/rmt/#s0	c	9	0x070n41
HP 7974A, 1600 cpi, AT&T, autorewind	/dev/rmt/#s0	c	9	0x070n40

<sup>1</sup> # is a number that identifies the magnetic tape drive. Replace # with any unique number (e.g., /dev/rmt/0s0 for the first mag tape). Record the numbers on the Step 6 tab.

<sup>2</sup> n is a number that identifies the address (set in step 3 of the Installation Procedure). Replace n with a 0 if the address was set to 0, use 2 if the address was set to 2, and so on.

---

# Installing the HP 7978A Tape Drive

---

## IMPORTANT!

The HP 7978A Tape Drive is to be installed by an HP Customer Engineer. The installation cost is included in the purchase price of the unit.

---

### Description

The HP 7978A is a 75 ips 1/2-inch 9-track open-reel tape drive supplied in an upright cabinet. It supports 1600 cpi Phase Encoded (PE) format and 6250 cpi Group Code Recording (GCR) format. The HP 7978A operates only in streaming mode.

### Support

The HP 7978A is supported on Series 200 Model 226 and 236 computers and on all Series 300 computers.

Operating/Language system support is as follows:

- **BASIC:** not supported.
- **Pascal Workstation:** not supported.
- **HP-UX Operating System:** supported on revision 5.1 or later with Series 200 computers; supported on revision 5.0 or later with Series 300 computers.

### Before You Begin

Your HP Customer Engineer will unpack and install your tape drive for you. The following procedure describes how to connect your tape drive to your Series 200/300 computer.

## HP 7978A Tape Drive Installation Procedure

---

### CAUTION

Do not attempt to operate the unit until your HP Customer Engineer has installed the unit for you.

---

#### 1. Play It Safe.

- a. Make arrangements with your HP Customer Engineer to have your tape drive installed.
- b. Turn your computer off, if it is not already off.
- c. Turn your HP 7978A Tape Drive on.

#### 2. Select Your Interface.

- a. Select one of the following interfaces, listed in order of preference for optimum tape performance:
  - HP 98625 Disc Interface
  - Built-in HP-IB Interface



### 3. Set the Address.

- a. Press the OFFLINE button until the OFFLINE indicator light turns on.
- b. Press the TEST ADDRESS button *twice* to make the ADDRESS indicator light turn on.
- c. Press the ENTER button. The current address will be displayed to the right of the ENTER button.
- d. Set the address:
  - If the HP 7978A is the first disc or tape drive you are connecting to the interface, press the TEST ADDRESS button until **0** appears in the display, unless address 0 has already been used.
  - If there is only *one* other disc or tape drive (besides this HP 7978A) already connected to the interface, press the TEST ADDRESS button until **2** appears in the display, unless address 2 has already been used.
  - If there are *two* other disc or tape drives (besides this HP 7978A) already connected to the interface, press the TEST ADDRESS button until **3** appears in the display, unless address 3 has already been used. If it has, choose any unused address.
- e. Press the ENTER button to assign the new address.
- f. Press the ONLINE button to turn on the ONLINE indicator light.

#### 4. **Connect the Tape Drive to Your Computer.**

- a. Find the HP-IB cable provided with the tape drive.
- b. Connect one end of the HP-IB cable to the HP-IB socket on the back of the tape drive. Tighten the thumb screws to secure the connection.
- c. Connect the other end of the HP-IB cable to the interface.

---

#### **NOTE**

If the interface already has several cables connected to it, connect your HP 7978A cable to one of the other devices on the interface.

---

#### 5. **Record the Address.**

- a. Make a note that address 0 (or the alternate address you chose in step 3) has been used and is no longer available on the interface you selected. Use the “Address Record” form on the Step 6 tab for this purpose.

---

## **The Next Step**

You have now installed your HP 7978A Tape Drive.

The following “Worksheet Entries” contain information needed to use your disc drive with HP-UX.

Copy this information to a worksheet (worksheets are found at the end of Step 1) or remember to refer here when you need it.

When finished, you’ll be ready to install your next peripheral.

# HP-UX System Worksheet Entries

## HP 7978A Connected to HP 98625 Disc Interface (Select Code 14)

Device Name	Path <sup>1</sup> Name	File Type	Major Number	Minor <sup>2</sup> Number
HP 7978A, 6250 cpi, Berkeley, no rewind	<i>/dev/rmt/#s0</i>	c	9	0x0e0n83
HP 7978A, 6250 cpi, Berkeley, autorewind	<i>/dev/rmt/#s0</i>	c	9	0x0e0n82
HP 7978A, 6250 cpi, AT&T, no rewind	<i>/dev/rmt/#s0</i>	c	9	0x0e0n81
HP 7978A, 6250 cpi, AT&T, autorewind	<i>/dev/rmt/#s0</i>	c	9	0x0e0n80
HP 7978A, 1600 cpi, Berkeley, no rewind	<i>/dev/rmt/#s0</i>	c	9	0x0e0n43
HP 7978A, 1600 cpi, Berkeley, autorewind	<i>/dev/rmt/#s0</i>	c	9	0x0e0n42
HP 7978A, 1600 cpi, AT&T, no rewind	<i>/dev/rmt/#s0</i>	c	9	0x0e0n41
HP 7978A, 1600 cpi, AT&T, autorewind	<i>/dev/rmt/#s0</i>	c	9	0x0e0n40

## HP 7978A Connected to Built-in HP-IB Interface (Select Code 7)

Device Name	Path <sup>1</sup> Name	File Type	Major Number	Minor <sup>2</sup> Number
HP 7978A, 6250 cpi, Berkeley, no rewind	<i>/dev/rmt/#s0</i>	c	9	0x070n83
HP 7978A, 6250 cpi, Berkeley, autorewind	<i>/dev/rmt/#s0</i>	c	9	0x070n82
HP 7978A, 6250 cpi, AT&T, no rewind	<i>/dev/rmt/#s0</i>	c	9	0x070n81
HP 7978A, 6250 cpi, AT&T, autorewind	<i>/dev/rmt/#s0</i>	c	9	0x070n80
HP 7978A, 1600 cpi, Berkeley, no rewind	<i>/dev/rmt/#s0</i>	c	9	0x070n43
HP 7978A, 1600 cpi, Berkeley, autorewind	<i>/dev/rmt/#s0</i>	c	9	0x070n42
HP 7978A, 1600 cpi, AT&T, no rewind	<i>/dev/rmt/#s0</i>	c	9	0x070n41
HP 7978A, 1600 cpi, AT&T, autorewind	<i>/dev/rmt/#s0</i>	c	9	0x070n40

<sup>1</sup> # is a number that identifies the magnetic tape drive. Replace # with any unique number (e.g., /dev/rmt/0s0 for the first mag tape). Record the numbers on the Step 6 tab.

<sup>2</sup> n is a number that identifies the address (set in step 3 of the Installation Procedure). Replace n with a 0 if the address was set to 0, use 2 if the address was set to 2, and so on.

---

# Installing the HP 9121 and 9122 Flexible Disc Drives

## Description

The HP 9121 records data on a single-sided 3½-inch disc and the HP 9122 records data on double-sided or single-sided 3½-inch discs. The HP 9121S and HP 9122S have a single disc drive, while the HP 9121D and the HP 9122D have two disc drives in the unit.

## Support

The HP 9121 and 9122 are supported on all Series 200 computers with boot ROM 3.0 or later, and on all Series 300 computers with boot ROM Rev. A or later.

Operating/Language system support is as follows:

- **BASIC:** The HP 9121 is supported on revision 2.0 or later with Series 200 computers; supported on revision 4.0 or later with Series 300 computers. The HP 9122 is supported on revision 3.0 or later with Series 200 computers; supported on revision 4.0 or later with Series 300 computers.
- **Pascal Workstation:** The HP 9121 is supported on revision 2.0 or later with Series 200 computers; supported on revision 3.1 or later with Series 300 computers. The HP 9122 is supported on revision 3.0 or later with Series 200 computers; supported on revision 3.1 or later with Series 300 computers.
- **HP-UX Operating System:** the HP 9121 is supported on revision 2.0 or later with Series 200 computers; supported on revision 5.0 or later with Series 300 computers. The HP 9122 is supported on revision 2.2L or later with Series 200 computers (excluding 2.3); supported on revision 5.0 or later with Series 300 computers.

## Before You Begin

The following procedure describes how to connect your HP 9121 and 9122 to your Series 200/300 computer. Before you do this, however, refer to the manual(s) that came with the drive to:

- Unpack the drive.
- Check the voltage switch setting.
- Check the fuse value.

## HP 9121 and 9122 Installation Procedure

### 1. Play It Safe.

- a. Turn your computer and disc drive off, if they are not already off.

### 2. Select Your Interface.

- a. Use either the built-in HP-IB interface or an HP 98624A HP-IB Interface.

### 3. Set the Address.

- a. On the back of the disc drive, find the set of four switches labeled “ADDRESS.”
- b. Set the HP-IB address:
  - If there is only *one* other disc or tape drive (besides this HP 9121/22) already connected to the interface, set the “ADDRESS” switches to 2 as shown below, unless address 2 has already been used.

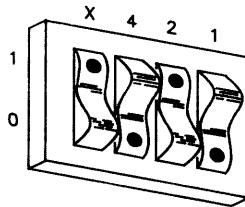

**Address 2**

- If there are *two* other disc or tape drives (besides this HP 9121/22) already connected to the interface, set the “ADDRESS” switches to 3 as shown below, unless address 3 has already been used. Refer to the manual that came with your disc drive for additional switch settings.

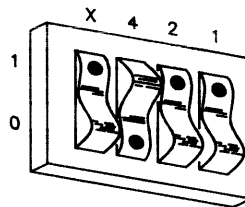

**Address 3**

#### 4. **Connect the Disc Drive to Your Computer.**

- a. Find the HP-IB cable provided with the disc drive.
- b. Connect one end of the HP-IB cable to the HP-IB socket on the back of the disc drive. Tighten the thumb screws to secure the connection.
- c. Connect the other end of the HP-IB cable to the interface.

---

#### **NOTE**

If the interface already has several cables connected to it, connect your HP 9121/22 cable to one of the other devices on the interface.

---

#### 5. **Connect the Power Cord.**

- a. Connect the female end of the power cord to the “AC LINE” socket on the back of the disc drive, and connect the other end to your power outlet.

#### 6. **Record the Address.**

- a. Make a note that address 0 (or the alternate address you chose in step 3) has been used and is no longer available on the interface you selected. Use the “Address Record” form on the Step 6 tab for this purpose.

---

## **The Next Step**

You have now installed your HP 9121/22 Disc Drive.

The following “Worksheet Entries” contain information needed to use your disc drive with various language/operating systems. Refer to the entries for the system you’ll be using (BASIC, Pascal or HP-UX).

Copy this information to a worksheet (worksheets are found at the end of Step 1) or remember to refer here when you need it.

When finished, you’ll be ready to install your next peripheral.

---

## BASIC System Worksheet Entries

### HP 9121/22 Connected to Built-in HP-IB Interface (Select Code 7)

Device Name	Msvs <sup>1</sup>	Driver Name	Interleave Factor
HP 9121 - Left	“:,70 $n$ ”	DISC	2
HP 9121D - Right	“:,70 $n$ ,1”	DISC	2
HP 9122 - Left	“:,70 $n$ ”	CS80	2
HP 9122D - Right	“:,70 $n$ ,1”	CS80	2

### HP 9121/22 Connected to HP 98624 HP-IB Interface (Select Code 8)

Device Name	Msvs <sup>1</sup>	Driver Name	Interleave Factor
HP 9121 - Left	“:,80 $n$ ”	DISC	2
HP 9121D - Right	“:,80 $n$ ,1”	DISC	2
HP 9122 - Left	“:,80 $n$ ”	CS80	2
HP 9122D - Right	“:,80 $n$ ,1”	CS80	2

---

## Pascal Workstation Worksheet Entries

Device Name	Unit Numbers <sup>2</sup>	Module Name	Interleave Factor
HP 9121 - Left	#3:	DISCHPIB & AMIGO	2
HP 9121D - Right	#4:	DISCHPIB & AMIGO	2
HP 9122 - Left	#3:	DISCHPIB & CS80	2
HP 9122D - Right	#4:	DISCHPIB & CS80	2

<sup>1</sup>  $n$  is a number that identifies the address (set in step 3 of the Installation Procedure). Replace  $n$  with a 0 if the address was set to 0, use 2 if the address was set to 2, and so on.

<sup>2</sup> If you have more than one flexible disc drive, the unit number assignments for your HP 9121/22 may be different. Refer to the section, “Determining Pascal Unit Numbers,” found at the end of this chapter, after you have installed *all* of your discs.

# HP-UX System Worksheet Entries

## HP 9121/22 Connected to Built-in HP-IB Interface (Select Code 7)

Device Name	Path <sup>1</sup> Name	File Type	Major Number	Minor <sup>2</sup> Number	Interleave Factor
HP 9121 - Left	<i>/dev/dsk/#s0</i>	b	2	0x070n00	2
HP 9121 - Left	<i>/dev/rdisk/#s0</i>	c	11	0x070n00	2
HP 9121D - Right	<i>/dev/dsk/#s0</i>	b	2	0x070n10	2
HP 9121D - Right	<i>/dev/rdisk/#s0</i>	c	11	0x070n10	2
HP 9122 - Left	<i>/dev/dsk/#s0</i>	b	0	0x070n00	2
HP 9122 - Left	<i>/dev/rdisk/#s0</i>	c	4	0x070n00	2
HP 9122D - Right	<i>/dev/dsk/#s0</i>	b	0	0x070n10	2
HP 9122D - Right	<i>/dev/rdisk/#s0</i>	c	4	0x070n10	2

## HP 9121/22 Connected to HP 98624 HP-IB Interface (Select Code 8)

Device Name	Path <sup>1</sup> Name	File Type	Major Number	Minor <sup>2</sup> Number	Interleave Factor
HP 9121 - Left	<i>/dev/dsk/#s0</i>	b	2	0x080n00	2
HP 9121 - Left	<i>/dev/rdisk/#s0</i>	c	11	0x080n00	2
HP 9121D - Right	<i>/dev/dsk/#s0</i>	b	2	0x080n10	2
HP 9121D - Right	<i>/dev/rdisk/#s0</i>	c	11	0x080n10	2
HP 9122 - Left	<i>/dev/dsk/#s0</i>	b	0	0x080n00	2
HP 9122 - Left	<i>/dev/rdisk/#s0</i>	c	4	0x080n00	2
HP 9122D - Right	<i>/dev/dsk/#s0</i>	b	0	0x080n10	2
HP 9122D - Right	<i>/dev/rdisk/#s0</i>	c	4	0x080n10	2

<sup>1</sup> # is a number that identifies the disc drive (e.g., 0 for the root disc, 1 for the next disc installed, etc.). Replace # with any unique number, and use the same number in both the */dev/dsk* and */dev/rdisk* entries (e.g., */dev/dsk/1s0* and */dev/rdisk/1s0*). Record the numbers on the Step 6 tab.

<sup>2</sup> n is a number that identifies the address (set in step 3 of the Installation Procedure). Replace n with a 0 if the address was set to 0, use 2 if the address was set to 2, and so on.



---

# Installing the HP 9125S and 9127A Flexible Disc Drives

## Description

The HP 9125S and 9127A are single 5¼-inch flexible disc drives.

## Support

- The HP 9125S is supported on all Series 200 computers with boot ROM 3.0 or later, and on all Series 300 computers with boot ROM Rev. A or later.
- The HP 9127A is supported on Series 200 Model 216, 220, 226, 236, and 237 computers with boot ROM 3.0 or later, and on all Series 300 computers with boot ROM Rev. A or later.

Operating/Language system support is as follows:

- **BASIC:** The HP 9125S is supported on revision 3.0 or later with Series 200 computers; supported on revision 4.0 or later with Series 300 computers. The HP 9127A is supported on revision 4.0 or later with Series 200 computers; supported on revision 4.0 or later with Series 300 computers.
- **Pascal Workstation:** The HP 9125S is supported on revision 3.0 or later with Series 200 computers; supported on revision 3.1 or later with Series 300 computers. The HP 9127A is supported on revision 3.1 or later with both Series 200 and Series 300 computers.
- **HP-UX Operating System:** The HP 9125S is supported on revision 5.1 or later with Series 200 computers; supported on revision 5.0 or later with Series 300 computers. The HP 9127A is supported on revision 5.1 or later with Series 200 computers; supported on revision 5.0 or later with Series 300 computers.

## Before You Begin

The following procedure describes how to connect your HP 9125S and HP 9127A to your Series 200/300 computer. Before you do this, however, refer to the manual(s) that came with the drive to:

- Unpack the drive.
- Check the voltage switch setting.
- Check the fuse value.

## HP 9125S and 9127A Installation Procedure

### 1. Play It Safe.

- a. Turn your computer and disc drive off, if they are not already off.

### 2. Select Your Interface.

- a. Use either the built-in HP-IB interface or an HHP 98624A HP-IB Interface.

### 3. Set the Address.

- a. On the back of the disc drive, find the HP-IB address wheel, labeled “ADDRESS.”
- b. Set the HP-IB address:
  - If this is the first disc or tape drive you are connecting to this interface, set the “ADDRESS” wheel to 0, unless address 0 has already been used.
  - If there is only *one* other disc or tape drive (besides this HP 9125S or 9127A) already connected to the interface, set the “ADDRESS” wheel to 2, unless address 2 has already been used.
  - If there are *two* other disc or tape drives (besides this HP 9125S or 9127A) already connected to the interface, set the “ADDRESS” wheel to 3, unless address 3 has already been used. If it has, choose any unused address.

### 4. Connect the Disc Drive to Your Computer.

- a. Find the HP-IB cable provided with the disc drive.
- b. Connect one end of the HP-IB cable to the HP-IB socket on the back of the disc drive. Tighten the thumb screws to secure the connection.
- c. Connect the other end of the HP-IB cable to the interface.

---

#### NOTE

If the interface already has several cables connected to it, connect your HP 9125/27 cable to one of the other devices on the interface.

---

## 5. Connect the Power Cord.

- a. Connect the female end of the power cord to the “AC LINE” socket on the back of the disc drive, and connect the other end to your power outlet.

## 6. Record the Address.

- a. Make a note that address 0 (or the alternate address you chose in step 3) has been used and is no longer available on the interface you selected. Use the “Address Record” form on the Step 6 tab for this purpose.

---

## The Next Step

You have now installed your HP 9125S/27A Disc Drive.

The following “Worksheet Entries” contain information needed to use your disc drive with various language/operating systems. Refer to the entries for the system you’ll be using (BASIC, Pascal or HP-UX).

Copy this information to a worksheet (worksheets are found at the end of Step 1) or remember to refer here when you need it.

When finished, you’ll be ready to install your next peripheral.

---

## BASIC System Worksheet Entries

### HP 9125S/27A Connected to Built-in HP-IB Interface (Select Code 7)

Device Name	Msvs <sup>1</sup>	Driver Name	Interleave Factor
HP 9125S/27A	“:70n”	CS80	2

### HP 9125S/27A Connected to HP 98624 HP-IB Interface (Select Code 8)

Device Name	Msvs <sup>1</sup>	Driver Name	Interleave Factor
HP 9125S/27A	“:,80n”	CS80	2

<sup>1</sup> *n* is a number that identifies the address (set in step 3 of the Installation Procedure). Replace *n* with a 0 if the address was set to 0, use 2 if the address was set to 2, and so on.

---

## Pascal Workstation Worksheet Entry

Device Name	Unit Numbers <sup>1</sup>	Module Name <sup>2</sup>	Interleave Factor
HP 9125S/27A	#3:	DISCHPIB & CS80	2

---

## HP-UX System Worksheet Entries

### HP 9125S/27A Connected to Built-in HP-IB Interface (Select Code 7)

Device Name	Path <sup>3</sup> Name	File Type	Major Number	Minor <sup>4</sup> Number	Interleave Factor
HP 9125S/27A	/dev/dsk/#s0	b	0	0x070n00	2
HP 9125S/27A	/dev/rdisk/#s0	c	4	0x070n00	2

### HP 9125S/27A Connected to HP 98624 HP-IB Interface (Select Code 8)

Device Name	Path <sup>3</sup> Name	File Type	Major Number	Minor <sup>4</sup> Number	Interleave Factor
HP 9125S/27A	/dev/dsk/#s0	b	0	0x080n00	2
HP 9125S/27A	/dev/rdisk/#s0	c	4	0x080n00	2

<sup>1</sup> If you have more than one flexible disc drive, the unit number assignment for your HP 9125S/27A may be different. Refer to the section, "Determining Pascal Unit Numbers," found at the end of this chapter, after you have installed *all* of your discs.

<sup>2</sup> You also need the DMA module if you you have DMA.

<sup>3</sup> # is a number that identifies the disc drive (e.g., 0 for the root disc, 1 for the next disc installed, etc.). Replace # with any unique number, and use the same number in both the /dev/dsk and /dev/rdisk entries (e.g., /dev/dsk/1s0 and /dev/rdisk/1s0). Record the numbers on the Step 6 tab.

<sup>4</sup> n is a number that identifies the address (set in step 3 of the Installation Procedure). Replace n with a 0 if the address was set to 0, use 2 if the address was set to 2, and so on.

---

# Installing the HP 9133D/H/L and 9134D/H/L Disc Drives

## Description

The HP 9133D/H/L contains a Winchester (hard) disc drive and a 3½-inch double-sided flexible disc drive. The HP 9134D/H/L contains a Winchester (hard) disc drive only.

## Support

The HP 9133D/H/L and HP 9134D/H/L are supported on all Series 200 computers with boot ROM 3.0 or later, and on all Series 300 computers with boot ROM Rev. A or later.

Operating/Language system support is as follows:

- **BASIC:** supported on revision 3.0 or later with Series 200 computers; supported on revision 4.0 or later with Series 300 computers.
- **Pascal Workstation:** supported on revision 3.0 or later with Series 200 computers; supported on revision 3.1 or later with Series 300 computers.
- **HP-UX Operating System:** supported on revision 2.0 or later with Series 200 computers; supported on revision 5.0 or later with Series 300 computers.

## Before You Begin

The following procedure describes how to connect your HP 9133D/H/L and HP 9134D/H/L to your Series 200/300 computer. Before you do this, however, refer to the manual(s) that came with the drive to:

- Unpack the drive.
- Check the voltage switch setting.
- Check the fuse value.

## HP 9133D/H/L and 9134D/H/L Installation Procedure

### 1. Play It Safe.

- a. Turn your computer and disc drive off, if they are not already off.

### 2. Select Your Interface.

- a. Select one of the following interfaces, listed in order of preference for optimum disc performance:
  - HP 98625 Disc Interface
  - Built-in HP-IB Interface or HP 98624A HP-IB Interface

### 3. Set the Address.

- a. On the back of the disc drive, find the HP-IB address wheel, labeled “ADDRESS.”
- b. Set the HP-IB address:
  - If there is only *one* other disc or tape drive (besides this HP 9133/34) already connected to the interface, set the “ADDRESS” wheel to 2, unless address 2 has already been used.
  - If there are *two* other disc or tape drives (besides this HP 9133/34) already connected to the interface, set the “ADDRESS” wheel on your HP 9133/34 to 3, unless address 3 has already been used. If it has, choose any unused address.

#### 4. Set the Configuration Switch.

---

##### CAN YOU SKIP THIS STEP?

The configuration switch partitions the disc into multiple volumes, making the disc act like several smaller disc drives. The switch is preset for a single volume. If you want multiple volumes on your disc (this is particularly advantageous with BASIC), continue with step 4. If you are satisfied with one volume (as is usually the case with the Pascal Workstation and HP-UX), skip to step 5.

---

- a. Find the configuration switch, labeled “CONFIGURATION,” on the back of the disc drive.
- b. Refer to the manual that came with your disc drive for a list of configuration switch settings.
- c. Decide how you would like your hard disc partitioned and set the configuration switch accordingly. Make this decision carefully, for you cannot change this setting without re-initializing the disc. Some factors to consider:
  - If you will be storing primarily large files on your disc, partition your disc into a few large volumes.
  - If you will be storing primarily small files on your disc, partition the disc into several small volumes.
  - If you will store both large and small files on the disc, then create both small and large volumes, or choose a good median volume size.
  - If storing more than one system on your disc (e.g., BASIC and the Pascal Workstation), or if you want to create different volume types on your disc, partition the disc according to the storage requirements of each system or volume.

---

### CAUTION

Files may be lost if you change the configuration switch after initializing the disc. Only change the configuration switch immediately before you initialize, or re-initialize, the disc.

---

#### 5. Connect the Disc Drive to Your Computer.

- a. Find the HP-IB cable provided with the disc drive.
- b. Connect one end of the HP-IB cable to the HP-IB socket on the back of the disc drive. Tighten the thumb screws to secure the connection.
- c. Connect the other end of the HP-IB cable to the interface.

---

### NOTE

If the interface already has several cables connected to it, connect your HP 9133/34 cable to one of the other devices on the interface.

---

#### 6. Connect the Power Cord.

- a. Connect the female end of the power cord to the power socket on the back of the disc drive, and connect the other end to your power outlet.

#### 7. Record the Address.

- a. Make a note that address 0 (or the alternate address you chose in step 3) has been used and is no longer available on the interface you selected. Use the “Address Record” form on the Step 6 tab for this purpose.



---

## The Next Step

You have now installed your HP 9133/34 Disc Drive.

The following “Worksheet Entries” contain information needed to use your disc drive with various language/operating systems. Refer to the entries for the system you’ll be using (BASIC, Pascal or HP-UX).

Copy this information to a worksheet (worksheets are found at the end of Step 1) or remember to refer here when you need it.

When finished, you’ll be ready to install your next peripheral.

---

## BASIC System Worksheet Entries

---

### NOTE

In this table, refer only to the entries for the number of volumes you selected. If you have one volume (default configuration), only the “1st vol.” entry applies to your disc.

---

### HP 9133/34 Connected to HP 98625 Disc Interface (Select Code 14)

Device Name	Msvs <sup>1</sup>	Driver Name	Interleave Factor
HP 9133/34 - Hard, 1st vol.	“:,140 $n$ ”	CS80	3
HP 9133/34 - Hard, 2nd vol.	“:,140 $n$ ,0,1”	CS80	3
HP 9133/34 - Hard, 3rd vol.	“:,140 $n$ ,0,2”	CS80	3
HP 9133/34 - Hard, 4th vol.	“:,140 $n$ ,0,3”	CS80	3
HP 9133/34 - Hard, 5th vol.	“:,140 $n$ ,0,4”	CS80	3
HP 9133/34 - Hard, 6th vol.	“:,140 $n$ ,0,5”	CS80	3
HP 9133/34 - Hard, 7th vol.	“:,140 $n$ ,0,6”	CS80	3
HP 9133/34 - Hard, 8th vol.	“:,140 $n$ ,0,7”	CS80	3
HP 9133 - Flexible	“:,140 $n$ ,1”	CS80	2

<sup>1</sup>  $n$  is a number that identifies the address (set in step 3 of the Installation Procedure). Replace  $n$  with a 0 if the address was set to 0, use 2 if the address was set to 2, and so on.

---

## BASIC System Worksheet Entries (Cont.)

---

### NOTE

In this table, refer only to the entries for the number of volumes you selected. For example, if you have one volume (default configuration), only the "1st vol." entry applies to your disc. If you partitioned your disc into three volumes, only the "1st vol." thru "3rd vol." entries apply.

---

### HP 9133/34 Connected to Built-in HP-IB Interface (Select Code 7)

Device Name	Msvs <sup>1</sup>	Driver Name	Interleave Factor <sup>2</sup>
HP 9133/34 - Hard, 1st vol.	“,70 $n$ ”	CS80	7
HP 9133/34 - Hard, 2nd vol.	“,70 $n$ ,0,1”	CS80	7
HP 9133/34 - Hard, 3rd vol.	“,70 $n$ ,0,2”	CS80	7
HP 9133/34 - Hard, 4th vol.	“,70 $n$ ,0,3”	CS80	7
HP 9133/34 - Hard, 5th vol.	“,70 $n$ ,0,4”	CS80	7
HP 9133/34 - Hard, 6th vol.	“,70 $n$ ,0,5”	CS80	7
HP 9133/34 - Hard, 7th vol.	“,70 $n$ ,0,6”	CS80	7
HP 9133/34 - Hard, 8th vol.	“,70 $n$ ,0,7”	CS80	7
HP 9133 - Flexible	“,70 $n$ ,1”	CS80	2

---

<sup>1</sup>  $n$  is a number that identifies the address (set in step 3 of the Installation Procedure). Replace  $n$  with a 0 if the address was set to 0, use 2 if the address was set to 2, and so on.

<sup>2</sup> For an HP 98620B DMA Card, the recommended interleave factor for the hard disc is 4 instead of 7.

---

## BASIC System Worksheet Entries (Cont.)

---

### NOTE

In this table, refer only to the entries for the number of volumes you selected. For example, if you have one volume (default configuration), only the "1st vol." entry applies to your disc. If you partitioned your disc into three volumes, only the "1st vol." thru "3rd vol." entries apply.

---

### HP 9133/34 Connected to HP 98624 HP-IB Interface (Select Code 8)

Device Name	Msvs <sup>1</sup>	Driver Name	Interleave Factor <sup>2</sup>
HP 9133/34 - Hard, 1st vol.	":,80n"	CS80	7
HP 9133/34 - Hard, 2nd vol.	":,80n,0,1"	CS80	7
HP 9133/34 - Hard, 3rd vol.	":,80n,0,2"	CS80	7
HP 9133/34 - Hard, 4th vol.	":,80n,0,3"	CS80	7
HP 9133/34 - Hard, 5th vol.	":,80n,0,4"	CS80	7
HP 9133/34 - Hard, 6th vol.	":,80n,0,5"	CS80	7
HP 9133/34 - Hard, 7th vol.	":,80n,0,6"	CS80	7
HP 9133/34 - Hard, 8th vol.	":,80n,0,7"	CS80	7
HP 9133 - Flexible	":,80n,1"	CS80	2

---

<sup>1</sup> *n* is a number that identifies the address (set in step 3 of the Installation Procedure). Replace *n* with a 0 if the address was set to 0, use 2 if the address was set to 2, and so on.

<sup>2</sup> For an HP 98620B DMA Card, the recommended interleave factor for the hard disc is 4 instead of 7.

## Pascal Workstation Worksheet Entries

Separate entries are provided for each version of the HP 9133 and HP 9134 (D, H or L), and for the standard format or Option 001. To find out which version you have, look at the back panel of the disc drive. To find out if you have option 001, look at the back panel under "Fixed Disc Format." Formats are as follows:

- **14.8 Mbyte:** HP 9133/34D standard format.
- **16.6 Mbyte:** HP 9133/34D option 001 format.
- **19.9 Mbyte:** HP 9133/34H standard format.
- **22.3 Mbyte:** HP 9133/34H option 001 format.
- **39.9 Mbyte:** HP 9133/34L standard format.
- **44.7 Mbyte:** HP 9133/34L option 001 format.

Device Name	Unit <sup>1</sup> Numbers	Module <sup>2</sup> Name	Interleave <sup>3</sup> Factor
HP 9133/34D - Hard, std.	#11: thru #24:	DISCHPIB & CS80	7
HP 9133/34D - Hard, opt. 001	#11: thru #26:	DISCHPIB & CS80	7
HP 9133D - Flexible	#3:	DISCHPIB & CS80	2
HP 9133/34H - Hard, std.	#11: thru #29:	DISCHPIB & CS80	6
HP 9133/34H - Hard, opt. 001	#11: thru #32:	DISCHPIB & CS80	6
HP 9133H - Flexible	#3:	DISCHPIB & CS80	2
HP 9133/34L - Hard, std.	#11: thru #40:	DISCHPIB & CS80	6
HP 9133/34L - Hard, opt. 001	#11: thru #40:	DISCHPIB & CS80	6
HP 9133L - Flexible	#3:	DISCHPIB & CS80	2

<sup>1</sup> If you have more than one hard disc drive, or if you partitioned your disc into multiple volumes in step 4, the unit number assignments for your HP 9133/34 may be different. Refer to the section, "Determining Pascal Unit Numbers," found at the end of this chapter, after you have installed *all* of your discs.

If you have more than one flexible disc drive, the unit number assignment for your HP 9133 may be different. Refer to the section, "Determining Pascal Unit Numbers", found at the end of this chapter, after you have *all* of your discs.

<sup>2</sup> If you are using a high-speed disc interface, include the DISC\_INTF module. If your computer also includes DMA, you also need the DMA module.

<sup>3</sup> For an HP 98620B DMA card, the recommended interleave factor for the hard disc is 4 on a built-in or HP 98624A HP-IB Interface, 3 on an HP 98625 Disc Interface.

# HP-UX System Worksheet Entries

## NOTE

In this table, refer only to the entries for the number of volumes you selected. If you have one volume (default configuration), only the "1st vol." entry applies to your disc.

### HP 9133/34 Connected to HP 98625 Disc Interface (Select Code 14)

Device Name	Path <sup>1</sup> Name	File Type	Major Number	Minor <sup>2</sup> Number	Interleave Factor
HP 9133/34 - Hard, 1st vol.	/dev/dsk/#s0	b	0	0x0e0n00	3
HP 9133/34 - Hard, 1st vol.	/dev/rdisk/#s0	c	4	0x0e0n00	3
HP 9133/34 - Hard, 2nd vol.	/dev/dsk/#s0	b	0	0x0e0n01	3
HP 9133/34 - Hard, 2nd vol.	/dev/rdisk/#s0	c	4	0x0e0n01	3
HP 9133/34 - Hard, 3rd vol.	/dev/dsk/#s0	b	0	0x0e0n02	3
HP 9133/34 - Hard, 3rd vol.	/dev/rdisk/#s0	c	4	0x0e0n02	3
HP 9133/34 - Hard, 4th vol.	/dev/dsk/#s0	b	0	0x0e0n03	3
HP 9133/34 - Hard, 4th vol.	/dev/rdisk/#s0	c	4	0x0e0n03	3
HP 9133/34 - Hard, 5th vol.	/dev/dsk/#s0	b	0	0x0e0n04	3
HP 9133/34 - Hard, 5th vol.	/dev/rdisk/#s0	c	4	0x0e0n04	3
HP 9133/34 - Hard, 6th vol.	/dev/dsk/#s0	b	0	0x0e0n05	3
HP 9133/34 - Hard, 6th vol.	/dev/rdisk/#s0	c	4	0x0e0n05	3
HP 9133/34 - Hard, 7th vol.	/dev/dsk/#s0	b	0	0x0e0n06	3
HP 9133/34 - Hard, 7th vol.	/dev/rdisk/#s0	c	4	0x0e0n06	3
HP 9133/34 - Hard, 8th vol.	/dev/dsk/#s0	b	0	0x0e0n07	3
HP 9133/34 - Hard, 8th vol.	/dev/rdisk/#s0	c	4	0x0e0n07	3
HP 9133 - Flexible	/dev/dsk/#s0	b	0	0x0e0n10	2
HP 9133 - Flexible	/dev/rdisk/#s0	c	4	0x0e0n10	2

<sup>1</sup> # is a number that identifies the disc drive (e.g., 0 for the root disc, 1 for the next disc installed, etc.). Replace # with any unique number, and use the same number in both the /dev/dsk and /dev/rdisk entries (e.g., /dev/dsk/1s0 and /dev/rdisk/1s0). Record the numbers on the Step 6 tab.

<sup>2</sup> n is a number that identifies the address (set in step 3 of the Installation Procedure). Replace n with a 0 if the address was set to 0, use 2 if the address was set to 2, and so on.

## HP-UX System Worksheet Entries (Cont.)

### NOTE

In this table, refer only to the entries for the number of volumes you selected. If you have one volume (default configuration), only the "1st vol." entry applies to your disc.

### HP 9133/34 Connected to Built-in HP-IB Interface (Select Code 7)

Device Name	Path <sup>1</sup> Name	File Type	Major Number	Minor <sup>2</sup> Number	Interleave <sup>3</sup> Factor
HP 9133/34 - Hard, 1st vol.	/dev/dsk/#s0	b	0	0x070n00	7
HP 9133/34 - Hard, 1st vol.	/dev/rdisk/#s0	c	4	0x070n00	7
HP 9133/34 - Hard, 2nd vol.	/dev/dsk/#s0	b	0	0x070n01	7
HP 9133/34 - Hard, 2nd vol.	/dev/rdisk/#s0	c	4	0x070n01	7
HP 9133/34 - Hard, 3rd vol.	/dev/dsk/#s0	b	0	0x070n02	7
HP 9133/34 - Hard, 3rd vol.	/dev/rdisk/#s0	c	4	0x070n02	7
HP 9133/34 - Hard, 4th vol.	/dev/dsk/#s0	b	0	0x070n03	7
HP 9133/34 - Hard, 4th vol.	/dev/rdisk/#s0	c	4	0x070n03	7
HP 9133/34 - Hard, 5th vol.	/dev/dsk/#s0	b	0	0x070n04	7
HP 9133/34 - Hard, 5th vol.	/dev/rdisk/#s0	c	4	0x070n04	7
HP 9133/34 - Hard, 6th vol.	/dev/dsk/#s0	b	0	0x070n05	7
HP 9133/34 - Hard, 6th vol.	/dev/rdisk/#s0	c	4	0x070n05	7
HP 9133/34 - Hard, 7th vol.	/dev/dsk/#s0	b	0	0x070n06	7
HP 9133/34 - Hard, 7th vol.	/dev/rdisk/#s0	c	4	0x070n06	7
HP 9133/34 - Hard, 8th vol.	/dev/dsk/#s0	b	0	0x070n07	7
HP 9133/34 - Hard, 8th vol.	/dev/rdisk/#s0	c	4	0x070n07	7
HP 9133 - Flexible	/dev/dsk/#s0	b	0	0x070n10	2
HP 9133 - Flexible	/dev/rdisk/#s0	c	4	0x070n10	2

<sup>1</sup> # is a number that identifies the disc drive (e.g., 0 for the root disc, 1 for the next disc installed, etc.). Replace # with any unique number, and use the same number in both the /dev/dsk and /dev/rdisk entries (e.g., /dev/dsk/1s0 and /dev/rdisk/1s0). Record the numbers on the Step 6 tab.

<sup>2</sup> n is a number that identifies the address (set in step 3 of the Installation Procedure). Replace n with a 0 if the address was set to 0, use 2 if the address was set to 2, and so on.

<sup>3</sup> For an HP 98620B DMA Card, the recommended interleave factor for the hard disc is 4 instead of 7.

# HP-UX System Worksheet Entries (Cont.)

## NOTE

In this table, refer only to the entries for the number of volumes you selected. If you have one volume (default configuration), only the "1st vol." entry applies to your disc.

### HP 9133/34 Connected to HP 98624 HP-IB Interface (Select Code 8)

Device Name	Path <sup>1</sup> Name	File Type	Major Number	Minor <sup>2</sup> Number	Interleave <sup>3</sup> Factor
HP 9133/34 - Hard, 1st vol.	/dev/dsk/#s0	b	0	0x080n00	7
HP 9133/34 - Hard, 1st vol.	/dev/rdisk/#s0	c	4	0x080n00	7
HP 9133/34 - Hard, 2nd vol.	/dev/dsk/#s0	b	0	0x080n01	7
HP 9133/34 - Hard, 2nd vol.	/dev/rdisk/#s0	c	4	0x080n01	7
HP 9133/34 - Hard, 3rd vol.	/dev/dsk/#s0	b	0	0x080n02	7
HP 9133/34 - Hard, 3rd vol.	/dev/rdisk/#s0	c	4	0x080n02	7
HP 9133/34 - Hard, 4th vol.	/dev/dsk/#s0	b	0	0x080n03	7
HP 9133/34 - Hard, 4th vol.	/dev/rdisk/#s0	c	4	0x080n03	7
HP 9133/34 - Hard, 5th vol.	/dev/dsk/#s0	b	0	0x080n04	7
HP 9133/34 - Hard, 5th vol.	/dev/rdisk/#s0	c	4	0x080n04	7
HP 9133/34 - Hard, 6th vol.	/dev/dsk/#s0	b	0	0x080n05	7
HP 9133/34 - Hard, 6th vol.	/dev/rdisk/#s0	c	4	0x080n05	7
HP 9133/34 - Hard, 7th vol.	/dev/dsk/#s0	b	0	0x080n06	7
HP 9133/34 - Hard, 7th vol.	/dev/rdisk/#s0	c	4	0x080n06	7
HP 9133/34 - Hard, 8th vol.	/dev/dsk/#s0	b	0	0x080n07	7
HP 9133/34 - Hard, 8th vol.	/dev/rdisk/#s0	c	4	0x080n07	7
HP 9133 - Flexible	/dev/dsk/#s0	b	0	0x080n10	2
HP 9133 - Flexible	/dev/rdisk/#s0	c	4	0x080010	2

<sup>1</sup> # is a number that identifies the disc drive (e.g., 0 for the root disc, 1 for the next disc installed, etc.). Replace # with any unique number, and use the same number in both the /dev/dsk and /dev/rdisk entries (e.g., /dev/dsk/1s0 and /dev/rdisk/1s0). Record the numbers on the Step 6 tab.

<sup>2</sup> n is a number that identifies the address (set in step 3 of the Installation Procedure). Replace n with a 0 if the address was set to 0, use 2 if the address was set to 2, and so on.

<sup>3</sup> For an HP 98620B DMA Card, the recommended interleave factor for the hard disc is 4 instead of 7.

---

# Installing the HP 9144A Tape Drive

## Description

The HP 9144A Tape Drive uses 1/4-inch tape cartridges. Two formatted storage capacities are available using the 88140SC (16.7 megabyte) or the 88140LC (67.0 megabyte) cartridges. The tape drive provides read-after-write capability for data verification as well as data recovery and auto-sparing, and it is compatible with existing 1/4-inch cartridges built into other HP mass storage devices.

## Support

The HP 9144A is supported on all Series 200 computers with boot ROM 3.0 or later, and on all Series 300 computers with boot ROM Rev. A or later.

Operating/Language system support is as follows:

- **BASIC:** supported on revision 2.1 or later with Series 200 computers; supported on revision 4.0 or later with Series 300 computers.
- **Pascal Workstation:** supported on revision 2.1 or later with Series 200 computers; supported on revision 3.1 or later with Series 300 computers.
- **HP-UX Operating System:** supported on revision 2.0 or later with Series 200 computers; supported on revision 5.0 or later with Series 300 computers

## Before You Begin

The following procedure describes how to connect your HP 9144A to your Series 200/300 computer. Before you do this, however, refer to the manual(s) that came with the tape drive to:

- Unpack the drive.
- Check the voltage select switch.



## HP 9144A Tape Drive Installation Procedure

### 1. Play It Safe.

- a. Turn your computer and tape drive off, if they are not already off.

### 2. Select Your Interface.

#### a. HP-UX Recommendations:

- If you selected an HP 98625 Disc Interface for your system disc(s), use the built-in HP-IB Interface for your HP 9144A tape drive.
- If you selected the built-in HP-IB interface for your system disc(s), use an HP 98624A HP-IB Interface for your HP 9144A tape drive (if available).
- Otherwise, use your built in HP-IB interface for both disc and tape drives.

#### b. BASIC and Pascal Workstation Recommendations:

- Connect the tape drive to either the HP 98625 Disc Interface or to the built-in HP-IB interface.

### 3. Set the Address.

- a. On the back of the tape drive, find the set of four switches labeled "ADDRESS."
- b. Set the HP-IB address:
  - If there is only *one* other disc or tape drive (besides this HP 9144A) already connected to the interface, set the "ADDRESS" switches to 2 as shown below, unless address 2 has already been used.

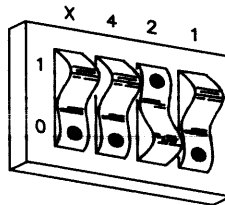

**Address 2**

- If there are *two* other disc or tape drives (besides this HP 9144A) already connected to the interface, set the “ADDRESS” switches to 3 as shown below, unless address 3 has already been used. Refer to the manual that came with your tape drive for additional switch settings.

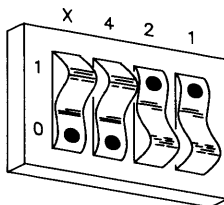

**Address 3**

**4. Connect the Tape Drive to Your Computer.**

- a. Find the HP-IB cable provided with the tape drive.
- b. Connect one end of the HP-IB cable to the HP-IB socket on the back of the tape drive. Tighten the thumb screws to secure the connection.
- c. Connect the other end of the HP-IB cable to the interface.

---

**NOTE**

If the interface already has several cables connected to it, connect your HP 9144A cable to one of the other devices on the interface.

---

**5. Connect the Power Cord.**

- a. Connect the female end of the power cord to the power socket on the back of the tape drive, and connect the other end to your power outlet.

**6. Record the Address.**

- a. Make a note that address 0 (or the alternate address you chose in step 3) has been used and is no longer available on the interface you selected. Use the “Address Record” form on the Step 6 tab for this purpose.

---

## The Next Step

You have now installed your HP 9144A Tape Drive.

The following “Worksheet Entries” contain information needed to use your tape drive with various language/operating systems. Refer to the entries for the system you’ll be using (BASIC, Pascal or HP-UX).

Copy this information to a worksheet (worksheets are found at the end of Step 1) or remember to refer here when you need it.

When finished, you’ll be ready to install your next peripheral.

---

## BASIC System Worksheet Entries

### HP 9144A Connected to HP 98625 Disc Interface (Select Code 14)

Device Name	Msvs <sup>1</sup>	Driver Name	Interleave Factor
HP 9144A	“:,140 $n$ ”	CS80	1

### HP 9144A Connected to Built-in HP-IB Interface (Select Code 7)

Device Name	Msvs <sup>1</sup>	Driver Name	Interleave Factor
HP 9144A	“:,70 $n$ ”	CS80	1

---

<sup>1</sup>  $n$  is a number that identifies the address (set in step 3 of the Installation Procedure). Replace  $n$  with a 0 if the address was set to 0, use 2 if the address was set to 2, and so on.

---

## Pascal Workstation Worksheet Entries

Device Name	Unit Numbers <sup>1</sup>	Module Name	Interleave Factor
HP 9144A	#41:	DISCHPIB & CS80	1

---

## HP-UX System Worksheet Entries

### HP 9144A Connected to Built-in HP-IB Interface (Select Code 7)

Device Name	Path <sup>2</sup> Name	File Type	Major Number	Minor <sup>3</sup> Number	Interleave Factor
HP 9144A	<i>/dev/ct/#s0</i>	b	0	0x070n00	1
HP 9144A	<i>/dev/rct/#s0</i>	c	4	0x070n00	1

### HP 9144A Connected to HP 98624 HP-IB Interface (Select Code 8)

Device Name	Path <sup>2</sup> Name	File Type	Major Number	Minor <sup>3</sup> Number	Interleave Factor
HP 9144A	<i>/dev/ct/#s0</i>	b	0	0x080n00	1
HP 9144A	<i>/dev/rct/#s0</i>	c	4	0x080n00	1

---

<sup>1</sup> If you have more than one tape drive, the unit number assignment for your HP 9144A may be different. Refer to the section, "Determining Pascal Unit Numbers," found at the end of this chapter, after you have installed *all* of your disc and tape drives.

<sup>2</sup> # is a number that identifies the tape drive. Replace # with any unique number, and use the same number in both the */dev/ct* and */dev/rct* entries (e.g., */dev/ct/1s0* and */dev/rct/1s0*). Record the numbers on the Step 6 tab.

<sup>3</sup> *n* is a number that identifies the address (set in step 3 of the Installation Procedure). Replace *n* with a 0 if the address was set to 0, use 2 if the address was set to 2, and so on.

---

# Installing the HP 9153A and 9154A Disc Drives

## Description

The HP 9153A contains a Winchester (hard) disc drive and a 3<sup>1</sup>/<sub>2</sub>-inch double-sided flexible disc drive. The HP 9154A contains a Winchester (hard) disc drive only.

## Support

The HP 9153A and HP 9154A are supported on Series 200 Model 217, 220, 226, 236 and 237 computers with boot ROM 3.0 or later, and on all Series 300 computers with boot ROM Rev. A or later.

Operating/Language system support is as follows:

- **BASIC:** supported on revision 3.0 or later with Series 200 computers; supported on revision 4.0 or later with Series 300 computers.
- **Pascal Workstation:** supported on revision 3.0 or later with Series 200 computers; supported on revision 3.1 or later with Series 300 computers.
- **HP-UX Operating System:** supported on revision 2.0 or later with Series 200 computers; supported on revision 5.0 or later with Series 300 computers.

## Before You Begin

The following procedure describes how to connect your HP 9153A and HP 9154A to your Series 200/300 computer. Before you do this, however, refer to the manual(s) that came with the drive to:

- Unpack the drive.
- Check the voltage switch setting.
- Check the fuse value.

## HP 9153A and 9154A Installation Procedure

### 1. Play It Safe.

- a. Turn your computer and disc drive off, if they are not already off.

### 2. Select Your Interface.

- a. Select one of the following interfaces, listed in order of preference for optimum disc performance:
  - HP 98625 Disc Interface
  - Built-in HP-IB Interface or HP 98624A HP-IB Interface

### 3. Set the Address.

- a. On the back of the disc drive, find the HP-IB address wheel, labeled “ADDRESS.”
- b. Set the HP-IB address:
  - If this is the first (or only) disc or tape drive you intend to connect to the interface, set the “ADDRESS” wheel to 0, unless address 0 has already been used.
  - If there is only *one* other disc or tape drive (besides this HP 9153/54) already connected to the interface, set the “ADDRESS” wheel to 2, unless address 2 has already been used.
  - If there are *two* other disc or tape drives (besides this HP 9153/54) already connected to the interface, set the “ADDRESS” wheel to 3, unless address 3 has already been used. If it has, choose any unused address.

#### 4. Set the Configuration Switch.

---

### CAN YOU SKIP THIS STEP?

---

The configuration switch partitions the disc into multiple volumes, making the disc act like several smaller disc drives. The switch is preset for a single volume. If you want multiple volumes on your disc (this is particularly advantageous with BASIC), continue with step 4. If you are satisfied with one volume (as is usually the case with the Pascal Workstation and HP-UX), skip to step 5.

---

- a. Find the HP-IB Module in the lower-left corner of the back of the disc drive (Note: the HP-IB module contains the HP-IB connector).
- b. Remove the two screws holding the module in place.
- c. Remove the HP-IB module by pulling the flange at the bottom straight out of the disc drive.
- d. Refer to the manual that came with your disc drive for a list of configuration switch settings.
- e. Decide how you would like your hard disc partitioned and set the configuration switch accordingly. Make this decision carefully, for you cannot change this setting without re-initializing the disc. Some factors to consider:
  - If you will be storing primarily large files on your disc, partition your disc into a few large volumes.
  - If you will be storing primarily small files on your disc, partition the disc into several small volumes.
  - If you will store both large and small files on the disc, choose a good median volume size.
  - If storing more than one system on your disc (e.g., BASIC and the Pascal Workstation), or if you want to create different volume types on your disc, partition the disc according to the storage requirements of each system or volume.
- f. Replace the HP-IB module in your disc drive.

---

### CAUTION

Files may be lost if you change the configuration switch after initializing the disc. Only change the configuration switch immediately before you initialize, or re-initialize, the disc.

---

#### 5. **Connect the Disc Drive to Your Computer.**

- a. Find the HP-IB cable provided with the disc drive.
- b. Connect one end of the HP-IB cable to the HP-IB socket on the back of the disc drive. Tighten the thumb screws to secure the connection.
- c. Connect the other end of the HP-IB cable to the interface.

---

### NOTE

If the interface already has several cables connected to it, connect your HP 9153/54 cable to one of the other devices on the interface.

---

#### 6. **Connect the Power Cord.**

- a. Connect the female end of the power cord to the “AC line” socket on the back of the disc drive, and connect the other end to your power outlet.

#### 7. **Record the Address.**

- a. Make a note that address 0 (or the alternate address you chose in step 3) has been used and is no longer available on the interface you selected. Use the “Address Record” form on the Step 6 tab for this purpose.



---

## The Next Step

You have now installed your HP 9153/54 Disc Drive.

The following “Worksheet Entries” contain information needed to use your disc drive with various language/operating systems. Refer to the entries for the system you’ll be using (BASIC, Pascal or HP-UX).

Copy this information to a worksheet (worksheets are found at the end of Step 1) or remember to refer here when you need it.

When finished, you’ll be ready to install your next peripheral.

---

## BASIC System Worksheet Entries

---

### NOTE

In this table, refer only to the entries for the number of volumes you selected. If you have one volume (default configuration), only the “1st vol.” entry applies to your disc.

---

### HP 9153/54 Connected to HP 98625 Disc Interface (Select Code 14)

Device Name	Msvs <sup>1</sup>	Driver Name	Interleave Factor
HP 9153/54 - Hard, 1st vol.	“:,140 $n$ ”	CS80	1
HP 9153/54 - Hard, 2nd vol.	“:,140 $n$ ,0,1”	CS80	1
HP 9153/54 - Hard, 3rd vol.	“:,140 $n$ ,0,2”	CS80	1
HP 9153/54 - Hard, 4th vol.	“:,140 $n$ ,0,3”	CS80	1
HP 9153/54 - Hard, 5th vol.	“:,140 $n$ ,0,4”	CS80	1
HP 9153/54 - Hard, 6th vol.	“:,140 $n$ ,0,5”	CS80	1
HP 9153/54 - Hard, 7th vol.	“:,140 $n$ ,0,6”	CS80	1
HP 9153/54 - Hard, 8th vol.	“:,140 $n$ ,0,7”	CS80	1
HP 9153 - Flexible	“:,140 $n$ ,1”	CS80	2

<sup>1</sup>  $n$  is a number that identifies the address (set in step 3 of the Installation Procedure). Replace  $n$  with a 0 if the address was set to 0, use 2 if the address was set to 2, and so on.

---

## BASIC System Worksheet Entries (Cont.)

---

### NOTE

In this table, refer only to the entries for the number of volumes you selected. If you have one volume (default configuration), only the "1st vol." entry applies to your disc.

---

### HP 9153/54 Connected to Built-in HP-IB Interface (Select Code 7)

Device Name	Msvs <sup>1</sup>	Driver Name	Interleave Factor <sup>2</sup>
HP 9153/54 - Hard, 1st vol.	“:,70 <i>n</i> ”	CS80	7
HP 9153/54 - Hard, 2nd vol.	“:,70 <i>n</i> ,0,1”	CS80	7
HP 9153/54 - Hard, 3rd vol.	“:,70 <i>n</i> ,0,2”	CS80	7
HP 9153/54 - Hard, 4th vol.	“:,70 <i>n</i> ,0,3”	CS80	7
HP 9153/54 - Hard, 5th vol.	“:,70 <i>n</i> ,0,4”	CS80	7
HP 9153/54 - Hard, 6th vol.	“:,70 <i>n</i> ,0,5”	CS80	7
HP 9153/54 - Hard, 7th vol.	“:,70 <i>n</i> ,0,6”	CS80	7
HP 9153/54 - Hard, 8th vol.	“:,70 <i>n</i> ,0,7”	CS80	7
HP 9153 - Flexible	“:,70 <i>n</i> ,1”	CS80	2

---

<sup>1</sup> *n* is a number that identifies the address (set in step 3 of the Installation Procedure). Replace *n* with a 0 if the address was set to 0, use 2 if the address was set to 2, and so on.

<sup>2</sup> For an HP 98620B DMA card, the recommended interleave factor for the hard disc is 3 instead of 7.

---

## BASIC System Worksheet Entries (Cont.)

---

### NOTE

In this table, refer only to the entries for the number of volumes you selected. If you have one volume (default configuration), only the "1st vol." entry applies to your disc.

---

### HP 9153/54 Connected to HP 98624 HP-IB Interface (Select Code 8)

Device Name	Msvs <sup>1</sup>	Driver Name	Interleave Factor <sup>2</sup>
HP 9153/54 - Hard, 1st vol.	“:,80 <i>n</i> ”	CS80	7
HP 9153/54 - Hard, 2nd vol.	“:,80 <i>n</i> ,0,1”	CS80	7
HP 9153/54 - Hard, 3rd vol.	“:,80 <i>n</i> ,0,2”	CS80	7
HP 9153/54 - Hard, 4th vol.	“:,80 <i>n</i> ,0,3”	CS80	7
HP 9153/54 - Hard, 5th vol.	“:,80 <i>n</i> ,0,4”	CS80	7
HP 9153/54 - Hard, 6th vol.	“:,80 <i>n</i> ,0,5”	CS80	7
HP 9153/54 - Hard, 7th vol.	“:,80 <i>n</i> ,0,6”	CS80	7
HP 9153/54 - Hard, 8th vol.	“:,80 <i>n</i> ,0,7”	CS80	7
HP 9153 - Flexible	“:,80 <i>n</i> ,1”	CS80	2

---

<sup>1</sup> *n* is a number that identifies the address (set in step 3 of the Installation Procedure). Replace *n* with a 0 if the address was set to 0, use 2 if the address was set to 2, and so on.

<sup>2</sup> For an HP 98620B DMA card, the recommended interleave factor for the hard disc is 4 instead of 7.

---

## Pascal Workstation Worksheet Entries

Device Name	Unit Numbers <sup>1</sup>	Module Name <sup>2</sup>	Interleave Factor <sup>3</sup>
HP 9153/54 - Hard	#11: thru #19:	DISCHPIB & CS80	7
HP 9153 - Flexible	#3:	DISCHPIB & CS80	2

---

<sup>1</sup> If you have more than one hard disc drive, or if you partitioned your disc into multiple volumes in step 4, the unit number assignments for your HP 9153/54 may be different. Refer to the section, "Determining Pascal Unit Numbers," found at the end of this chapter, after you have installed *all* of your discs.

If you have more than one flexible disc drive, the unit number assignment for your HP 9153 may be different. Refer to the section, "Determining Pascal Unit Numbers," found at the end of this chapter, after you have installed *all* of your discs.

<sup>3</sup> For an HP 98620B DMA Controller Card, the recommended interleave factor for the hard disc is 2 on a built-in or HP 98624A HP-IB Interface, 1 on an HP 98625 Disc Interface.

<sup>3</sup> If you are using a high-speed disc interface, include the DISC\_INTF module. If your computer also includes DMA, you also need the DMA module.

# HP-UX System Worksheet Entries

## NOTE

In this table, refer only to the entries for the number of volumes you selected. If you have one volume (default configuration), only the "1st vol." entry applies to your disc.

### HP 9153/54 Connected to HP 98625 Disc Interface (Select Code 14)

Device Name	Path <sup>1</sup> Name	File Type	Major Number	Minor <sup>2</sup> Number	Interleave Factor
HP 9153/54 - Hard, 1st vol.	<i>/dev/dsk/#s0</i>	b	0	0x0e0n00	1
HP 9153/54 - Hard, 1st vol.	<i>/dev/rdisk/#s0</i>	c	4	0x0e0n00	1
HP 9153/54 - Hard, 2nd vol.	<i>/dev/dsk/#s0</i>	b	0	0x0e0n01	1
HP 9153/54 - Hard, 2nd vol.	<i>/dev/rdisk/#s0</i>	c	4	0x0e0n01	1
HP 9153/54 - Hard, 3rd vol.	<i>/dev/dsk/#s0</i>	b	0	0x0e0n02	1
HP 9153/54 - Hard, 3rd vol.	<i>/dev/rdisk/#s0</i>	c	4	0x0e0n02	1
HP 9153/54 - Hard, 4th vol.	<i>/dev/dsk/#s0</i>	b	0	0x0e0n03	1
HP 9153/54 - Hard, 4th vol.	<i>/dev/rdisk/#s0</i>	c	4	0x0e0n03	1
HP 9153/54 - Hard, 5th vol.	<i>/dev/dsk/#s0</i>	b	0	0x0e0n04	1
HP 9153/54 - Hard, 5th vol.	<i>/dev/rdisk/#s0</i>	c	4	0x0e0n04	1
HP 9153/54 - Hard, 6th vol.	<i>/dev/dsk/#s0</i>	b	0	0x0e0n05	1
HP 9153/54 - Hard, 6th vol.	<i>/dev/rdisk/#s0</i>	c	4	0x0e0n05	1
HP 9153/54 - Hard, 7th vol.	<i>/dev/dsk/#s0</i>	b	0	0x0e0n06	1
HP 9153/54 - Hard, 7th vol.	<i>/dev/rdisk/#s0</i>	c	4	0x0e0n06	1
HP 9153/54 - Hard, 8th vol.	<i>/dev/dsk/#s0</i>	b	0	0x0e0n07	1
HP 9153/54 - Hard, 8th vol.	<i>/dev/rdisk/#s0</i>	c	4	0x0e0n07	1
HP 9153 - Flexible	<i>/dev/dsk/#s0</i>	b	0	0x0e0n10	2
HP 9153 - Flexible	<i>/dev/rdisk/#s0</i>	c	4	0x0e0n10	2

<sup>1</sup> # is a number that identifies the disc drive (e.g., 0 for the root disc, 1 for the next disc installed, etc.). Replace # with any unique number, and use the same number in both the */dev/dsk* and */dev/rdisk* entries (e.g., */dev/dsk/1s0* and */dev/rdisk/1s0*). Record the numbers on the Step 6 tab.

<sup>2</sup> n is a number that identifies the address (set in step 3 of the Installation Procedure). Replace n with a 0 if the address was set to 0, use 2 if the address was set to 2, and so on.

# HP-UX System Worksheet Entries (Cont.)

## NOTE

In this table, refer only to the entries for the number of volumes you selected. If you have one volume (default configuration), only the "1st vol." entry applies to your disc.

### HP 9153/54 Connected to Built-in HP-IB Interface (Select Code 7)

Device Name	Path <sup>1</sup> Name	File Type	Major Number	Minor <sup>2</sup> Number	Interleave <sup>3</sup> Factor
HP 9153/54 - Hard, 1st vol.	/dev/dsk/#s0	b	0	0x070n00	3
HP 9153/54 - Hard, 1st vol.	/dev/rdisk/#s0	c	4	0x070n00	3
HP 9153/54 - Hard, 2nd vol.	/dev/dsk/#s0	b	0	0x070n01	3
HP 9153/54 - Hard, 2nd vol.	/dev/rdisk/#s0	c	4	0x070n01	3
HP 9153/54 - Hard, 3rd vol.	/dev/dsk/#s0	b	0	0x070n02	3
HP 9153/54 - Hard, 3rd vol.	/dev/rdisk/#s0	c	4	0x070n02	3
HP 9153/54 - Hard, 4th vol.	/dev/dsk/#s0	b	0	0x070n03	3
HP 9153/54 - Hard, 4th vol.	/dev/rdisk/#s0	c	4	0x070n03	3
HP 9153/54 - Hard, 5th vol.	/dev/dsk/#s0	b	0	0x070n04	3
HP 9153/54 - Hard, 5th vol.	/dev/rdisk/#s0	c	4	0x070n04	3
HP 9153/54 - Hard, 6th vol.	/dev/dsk/#s0	b	0	0x070n05	3
HP 9153/54 - Hard, 6th vol.	/dev/rdisk/#s0	c	4	0x070n05	3
HP 9153/54 - Hard, 7th vol.	/dev/dsk/#s0	b	0	0x070n06	3
HP 9153/54 - Hard, 7th vol.	/dev/rdisk/#s0	c	4	0x070n06	3
HP 9153/54 - Hard, 8th vol.	/dev/dsk/#s0	b	0	0x070n07	3
HP 9153/54 - Hard, 8th vol.	/dev/rdisk/#s0	c	4	0x070n07	3
HP 9153 - Flexible	/dev/dsk/#s0	b	0	0x070n10	2
HP 9153 - Flexible	/dev/rdisk/#s0	c	4	0x070n10	2

<sup>1</sup> # is a number that identifies the disc drive (e.g., 0 for the root disc, 1 for the next disc installed, etc.). Replace # with any unique number, and use the same number in both the /dev/dsk and /dev/rdisk entries (e.g., /dev/dsk/1s0 and /dev/rdisk/1s0). Record the numbers on the Step 6 tab.

<sup>2</sup> n is a number that identifies the address (set in step 3 of the Installation Procedure). Replace n with a 0 if the address was set to 0, use 2 if the address was set to 2, and so on.

<sup>3</sup> For an HP 98620B DMA card, the interleave factor for the hard disc is 2 instead of 3.

## HP-UX System Worksheet Entries (Cont.)

### NOTE

In this table, refer only to the entries for the number of volumes you selected. If you have one volume (default configuration), only the "1st vol." entry applies to your disc.

### HP 9153/54 Connected to HP 98624 HP-IB Interface (Select Code 8)

Device Name	Path <sup>1</sup> Name	File Type	Major Number	Minor <sup>2</sup> Number	Interleave <sup>3</sup> Factor
HP 9153/54 - Hard, 1st vol.	/dev/dsk/#s0	b	0	0x080n00	3
HP 9153/54 - Hard, 1st vol.	/dev/rdisk/#s0	c	4	0x080n00	3
HP 9153/54 - Hard, 2nd vol.	/dev/dsk/#s0	b	0	0x080n01	3
HP 9153/54 - Hard, 2nd vol.	/dev/rdisk/#s0	c	4	0x080n01	3
HP 9153/54 - Hard, 3rd vol.	/dev/dsk/#s0	b	0	0x080n02	3
HP 9153/54 - Hard, 3rd vol.	/dev/rdisk/#s0	c	4	0x080n02	3
HP 9153/54 - Hard, 4th vol.	/dev/dsk/#s0	b	0	0x080n03	3
HP 9153/54 - Hard, 4th vol.	/dev/rdisk/#s0	c	4	0x080n03	3
HP 9153/54 - Hard, 5th vol.	/dev/dsk/#s0	b	0	0x080n04	3
HP 9153/54 - Hard, 5th vol.	/dev/rdisk/#s0	c	4	0x080n04	3
HP 9153/54 - Hard, 6th vol.	/dev/dsk/#s0	b	0	0x080n05	3
HP 9153/54 - Hard, 6th vol.	/dev/rdisk/#s0	c	4	0x080n05	3
HP 9153/54 - Hard, 7th vol.	/dev/dsk/#s0	b	0	0x080n06	3
HP 9153/54 - Hard, 7th vol.	/dev/rdisk/#s0	c	4	0x080n06	3
HP 9153/54 - Hard, 8th vol.	/dev/dsk/#s0	b	0	0x080n07	3
HP 9153/54 - Hard, 8th vol.	/dev/rdisk/#s0	c	4	0x080n07	3
HP 9153 - Flexible	/dev/dsk/#s0	b	0	0x080n10	2
HP 9153 - Flexible	/dev/rdisk/#s0	c	4	0x080n10	2

<sup>1</sup> # is a number that identifies the disc drive (e.g., 0 for the root disc, 1 for the next disc installed, etc.). Replace # with any unique number, and use the same number in both the /dev/dsk and /dev/rdisk entries (e.g., /dev/dsk/1s0 and /dev/rdisk/1s0). Record the numbers on the Step 6 tab.

<sup>2</sup> n is a number that identifies the address (set in step 3 of the Installation Procedure). Replace n with a 0 if the address was set to 0, use 2 if the address was set to 2, and so on.

<sup>3</sup> For an HP 98620B DMA card, the interleave factor for the hard disc is 2 instead of 3.

---

# Installing the HP 9895A Disc Drive

## Description

The HP 9895A is an 8-inch, double- or single-sided, double-density, flexible disc drive.

## Support

The HP 9895A disc drive is supported on all Series 200 computers with boot ROM 3.0 or later. Support for Series 300 computers was planned but not yet authorized at time of printing.

Operating/Language system support is as follows:

- **BASIC:** supported on revision 2.0 or later with Series 200 computers.
- **Pascal Workstation:** supported on revision 1.0 or later with Series 200 computers.
- **HP-UX Operating System:** supported on revision 2.0 or later with Series 200 computers.

## Before You Begin

The following procedure describes how to connect your HP 9895A disc drive to your Series 200 computer. Before you do this, however, refer to the manual(s) that came with the drive to:

- Unpack the drive.
- Check the voltage switch setting.
- Check the line frequency.
- Check the fuse value.



# Adding Printers

---

If you need to install any of the products listed below, turn to the indicated page number and follow the instructions. Otherwise, move on to Step 8.

<b>Printer Name</b>	<b>Page Number</b>
HP 2225A <i>ThinkJet</i> Printer	See page 7-2
HP 2227A/B <i>QuietJet Plus</i> and 2228A <i>QuietJet</i> printers	See page 7-7
HP 2563A, 2565A and 2666A Printers	See page 7-14
HP 2601A Daisywheel Printer	See page 7-19
HP 2602A Daisywheel Printer	See page 7-23
HP 2608S Dot-matrix Printer	See page 7-27
HP 2671A/G Thermal Printer	See page 7-31
HP 2673A Thermal Printer	See page 7-36
HP 2686A/D <i>LaserJet</i> and HP 33440A <i>LaserJet-II</i> Printers	See page 7-41
HP 2932A and HP 2934A Printers	See page 7-47
HP 82905B and HP 82906A Printers	See page 7-53
HP 9876A Thermal Printer	See page 7-58

---

# Installing the HP 2225A ThinkJet Printer

## Description

The HP 2225A *ThinkJet* printer connects to the computer through the HP-IB interface.

## Support

The HP 2225A *ThinkJet* printer is supported on all Series 200 and Series 300 computers.

Operating/Language system support is as follows:

- **BASIC:** supported on revision 2.0 or later with Series 200 computers; supported on revision 4.0 or later with Series 300 computers.
- **Pascal Workstation:** supported on revision 3.0 or later with Series 200 computers; supported on revision 3.1 or later with Series 300 computers.
- **HP-UX Operating System:** supported on revision 2.0 or later with Series 200 computers; supported on revision 5.0 or later with Series 300 computers.

## Before You Begin

The following procedure describes how to connect your HP 2225A *ThinkJet* printer to your Series 200/300 computer. Before you do this, however, refer to the manual(s) that came with your printer to:

- Unpack the printer.
- Check the line voltage.

## ThinkJet Printer Installation Procedure

### 1. Play It Safe.

- a. Turn your computer and printer off, if they are not already off.

### 2. Select Your Interface.

- a. Use either the built-in HP-IB interface or an IIP 98624A HP-IB Interface. If using HP-UX, avoid placing the *ThinkJet* on the same interface used by your disc or tape drives, if possible. If using the Pascal Workstation, select the built-in HP-IB interface.

### 3. Set the Address.

---

#### CAN YOU SKIP THIS STEP?

If this is the first (or only) printer you are connecting to the interface, you can skip to step 4. The address is preset to 1 and need not be changed—*unless* you have changed the address of some other device on the interface to 1. The Pascal Workstation *expects* to find the printer at address 1.

---

- a. Find the set of switches to the left of the HP-IB connector. Switches A1 through A5 in this group determine the address.
- b. Set the address switches to 4 as shown below, unless address 4 has been used elsewhere. Refer to the manual that came with the printer if you need additional switch settings.

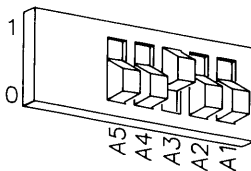

**Address 4**

#### 4. **Connect the Printer to the Computer.**

- a. Get an HP-IB cable.
- b. Connect one end of the HP-IB cable to the HP-IB connector on the back of the printer. Tighten the thumb screws to secure the connection.
- c. Connect the other end of the HP-IB cable to the interface.

---

#### **NOTE**

If the interface already has several cables connected to it, connect the printer's cable to one of the other devices on the interface.

---

#### 5. **Connect the Power Cord.**

- a. Connect the female end of the power cord to the power socket on the back of the printer, and connect the other end to your power outlet.

#### 6. **Record the Address.**

- a. Make a note that address 1 (or the alternate address you chose in step 3) has been used and is no longer available on the interface you selected. Use the "Address Record" form on the Step 6 tab for this purpose.

### **Final Preparations**

Refer to your printer's manual(s) to:

- Load the print head cartridge.
- Load the paper.
- Perform the printer's self-test.

---

## The Next Step

You have now installed your HP 2225A *ThinkJet* Printer.

The following “Worksheet Entries” contain information needed to use your printer with various language/operating systems. Refer to the entries for the system you’ll be using (BASIC, Pascal or HP-UX).

Copy this information to a worksheet (worksheets are found at the end of Step 1) or remember to refer here when you need it.

When finished, you’ll be ready to install your next peripheral.

---

## BASIC System Worksheet Entries

### HP 2225A ThinkJet Connected to Built-in HP-IB Interface (Select Code 7)

Device Name	Device Selector <sup>1</sup>
HP 2225A <i>ThinkJet</i>	70 $n$

### HP 2225A ThinkJet Connected to HP 98624A HP-IB Interface (Select Code 8)

Device Name	Device Selector <sup>1</sup>
HP 2225A <i>ThinkJet</i>	80 $n$

---

<sup>1</sup>  $n$  is a number that identifies the address (set in step 3 of the Installation Procedure). Replace  $n$  with a 1 if the address was set to 1, use 4 if the address was set to 4, and so on.

---

## Pascal Workstation Worksheet Entry

---

### NOTE

The Pascal Workstation expects to find the printer on the built-in HP-IB interface at address 1. If you did not set up your printer this way, you must make some modifications to the Pascal Workstation. See the "Special Configurations" section of the *Pascal Workstation System* manual for details.

---

Device Name	Unit Number
HP 2225A <i>ThinkJet</i>	#6:

---

## HP-UX System Worksheet Entries

### HP 2225A ThinkJet Connected to Built-in HP-IB Interface (Select Code 7)

Device Name	Path Name	File Type	Major No.	Minor No. <sup>1</sup>
HP 2225A <i>ThinkJet</i>	/dev/lp2225	c	7	0x070n00
HP 2225A <i>ThinkJet</i>	/dev/rlp2225	c	21	0x070n00

### HP 2225A ThinkJet Connected to HP 98624 HP-IB Interface (Select Code 8)

Device Name	Path Name	File Type	Major No.	Minor No. <sup>1</sup>
HP 2225A <i>ThinkJet</i>	/dev/lp2225	c	7	0x080n00
HP 2225A <i>ThinkJet</i>	/dev/rlp2225	c	21	0x080n00

---

<sup>1</sup> *n* is a number that identifies the address (set in step 3 of the Installation Procedure). Replace *n* with a 1 if the address was set to 1, use 4 if the address was set to 4, and so on.

---

# Installing the HP 2227A/B QuietJet Plus and 2228A QuietJet Printers

## Description

The HP 2227A *QuietJet Plus* and 2228A *QuietJet* printers both connect to the computer through an RS-232C interface. The HP 2227B *QuietJetPlus* printer connects to the computer through an HP-IB interface.

## Support

The HP2227A/B and 2228A are supported on all Series 300 computers.

Operating/Language system support is as follows:

- **BASIC:** HP 2227A/B and 2228B are supported on revision 5.0 or later with Series 300 computers.
- **Pascal Workstation:** HP 2227B is supported on revision 3.2 or later with Series 300 computers (HP-IB interface only).
- **HP-UX Operating System:** HP 2227A/B and HP 2228A are supported on revision 5.1 or later with Series 300 computers.

## Before You Begin

The following procedure describes how to connect your HP 2227A/B QuietJet Plus or 2228A QuietJet printer to your Series 300 computer. Before you do this, however, refer to the manual(s) that came with your printer to:

- Unpack the printer.
- Connect the Power Module 1.

## HP 2227A/B and 2228A Installation Procedure

### 1. Play It Safe.

- a. Turn your computer and printer off, if they are not already off.

### 2. Select Your Interface.

- If you have an **HP 2227A or 2228A** printer: use only an RS-232C interface. Use any one of the following RS-232C interfaces:
  - The built-in RS-232 interface in a Series 300 computer.
  - HP 98626A RS-232C Interface.
  - HP 98628A Datacomm Interface.
  - HP 98644A RS-232C Serial Interface.
- If you have an **HP 2227B** printer: use either the built-in HP-IB interface or an HP 98624A HP-IB interface. If using HP-UX, avoid placing the printer on the same interface used by your disc or tape drives, if possible. If using the Pascal Workstation, select the built-in HP-IB interface.

### 3. Set the Address.

---

#### CAN YOU SKIP THIS STEP?

Skip to step 4 if your printer is an HP 2227A or 2228A (RS-232C interface).

For the HP 2227B printer (HP-IB interface), if this is the first (or only) printer you are connecting to the interface, skip to step 4. The address should be preset to 1 and shouldn't need to be changed - *unless* you have changed the address of some other device on the interface to 1. The Pascal Workstation *expects* to find the printer at address 1.

---

- a. Find the two banks of switches located inside the front cover.



- b. Refer to the manual that came with the printer to set the address to one that is currently unused.
- c. Record the address on the “Address Record” form on the Step 6 tab.

#### 4. Connect Printer to Computer

- If you have an **HP 2227A or 2228A** printer (RS-232C interface):
  - a. Select your cable(s). Following are *some* of the possible cabling combinations you can use. Combinations other than those listed may also work.
    - **Series 300 Built-in Interface:** connect an HP 40242G to the printer if an HP 98561-61604 cable is connected to the interface; or connect an HP 40242G cable directly between the printer and the interface.
    - **HP 98626A Interface:** connect an HP 17255D cable to the printer if an HP 5061-4215 DTE cable is connected to the interface; or connect an HP 40242M cable to the printer if an HP 5061-4216 DCE cable is connected to the interface (HP-UX and Pascal only).
    - **HP 98628A Interface:** connect an HP 17255D cable to the printer if an HP 5061-4215 DTE cable is connected to the interface; or connect an HP 40242M cable to the printer if an HP 5061-4216 DCE cable is connected to the interface.
    - **HP 98644A Interface:** connect an HP 40242G cable directly between the printer and the interface.
  - b. Connect one (male) end of the printer’s cable to the connector on the printer. Lock the connection in place with the screws.
  - c. If your interface connection requires one or more additional cables, connect the remaining cable(s) to the interface.

- If you have an **HP 2227B** printer HP-IB (interface):
  - a. Get an HP-IB cable.
  - b. Connect one end of the HP-IB cable to the HP-IB connector on the back of the printer. Tighten the thumb screws to secure the connection.
  - c. Connect the other end of the HP-IB cable to the interface.

---

**NOTE**

If the interface already has several cables connected to it, connect the printer's cable to one of the other devices on the interface.

---

**5. Connect the Power Cord.**

- a. Connect the female end of the power cord to the power socket on the back of the printer, and connect the other end to your power outlet.

## **Final Preparations**

Refer to your printer manual(s) to:

- Prime and install the print cartridge.
- Load and adjust paper.
- Run the printer's self-test.

---

## **The Next Step**

You have now installed your HP 2227A, 2227B or 2228A printer.

The following "Worksheet Entries" contain information needed to use your printer with various language/operating systems. Refer to the entries for the system you'll be using (BASIC, Pascal, or HP-UX).

Copy this information to a worksheet (worksheets are found at the end of Step 1) or remember to refer here when you need it.

When finished, you'll be ready to install your next peripheral.

---

## BASIC System Worksheet Entries

### HP 2227A or 2228A Connected to RS-232 Interface

Device Name	Device Selector <sup>1</sup>
HP 2227A <i>QuietJet Plus</i>	9
HP 2228A <i>QuietJet</i>	9

### HP 2227B Connected to Built-In HP-IB Interface (Select Code 7)

Device Name	Device Selector <sup>2</sup>
HP 2227B <i>QuietJet Plus</i>	70n

### HP 2227B Connected to HP 98624A HP-IB Interface (Select Code 8)

Device Name	Device Selector <sup>2</sup>
HP 2227B <i>QuietJet Plus</i>	80n

---

## Pascal Workstation Worksheet Entries

Device Name	Unit Number
HP 2227B <i>QuietJet Plus</i>	#6:

---

<sup>1</sup> If you connected the HP 2227A or 2228A to an interface with a select code other than 9, write in your select code instead of 9.

<sup>2</sup> *n* is a number that identifies the address (set in step 3 of the Installation Procedure). Replace *n* with a 1 is the address was set to 1, use 4 if the address was set to 4, and so on.

---

## HP-UX System Worksheet Entries

For spooled printing, use the 2686a spooler model file. For unspooled printing, insert the following shell commands into */etc/rc*:

```
nohup sleep 2000000000 < /dev/lp2686 &  
stty -parenb -ienqak cs8 9600 -cstopb -clocal ixon opost onlcr tab3 <  
/dev/lp2686
```

To configure the interface for raster graphics printing, execute the following *stty* command (or equivalent *ioctl(2)* calls). Reissue the sequence above after printing raster data.

```
stty -parenb -ienqak cs8 9600 -cstopb -clocal ixon -opost < /dev/lp2686
```

### HP 2227A/28A Connected to Series 300 Built-in Interface

Device Name	Path Name	File Type	Major No.	Minor No.
HP 2227A/28A, select code 9	<i>/dev/lp2227a</i>	c	1	0x090004

### HP 2227A/28A Connected to HP 98626A, 98628A or 98644A Interface

Device Name	Path Name	File Type	Major No.	Minor No.
HP 2227A/28A, select code 9	<i>/dev/lp2227a</i>	c	1	0x090004
HP 2227A/28A, select code 10	<i>/dev/lp2227a</i>	c	1	0x0a0004
HP 2227A/28A, select code 15	<i>/dev/lp2227a</i>	c	1	0x0f0004
HP 2227A/28A, select code 16	<i>/dev/lp2227a</i>	c	1	0x100004
HP 2227A/28A, select code 17	<i>/dev/lp2227a</i>	c	1	0x110004
HP 2227A/28A, select code 19	<i>/dev/lp2227a</i>	c	1	0x130004
HP 2227A/28A, select code 20	<i>/dev/lp2227a</i>	c	1	0x140004

---

## HP-UX System Worksheet Entries (Cont.)

### HP 2227B Connected to Built-in HP-IB Interface (Select Code 7)

Device Name	Path Name	File Type	Major Number	Minor <sup>1</sup> Number
HP 2227B <i>QuietJet Plus</i>	<i>/dev/lp2227b</i>	c	7	0x070n00
HP 2227B <i>QuietJet Plus</i>	<i>/dev/rtp2227b</i>	c	21	0x070n00

### HP 2227B Connected to HP 98624 HP-IB Interface (Select Code 8)

Device Name	Path Name	File Type	Major Number	Minor <sup>1</sup> Number
HP 2227B <i>QuietJet Plus</i>	<i>/dev/lp2227b</i>	c	7	0x080n00
HP 2227B <i>QuietJet Plus</i>	<i>/dev/rtp2227b</i>	c	21	0x080n00

---

<sup>1</sup> *n* is a number that identifies the address (set in step 3 of the Installation Procedure). Replace *n* with a 1 if the address was set to 1, use 4 if the address was set to 4, and so on.

---

# Installing the HP 2563A, 2565A and 2566A Printers

## Description

The HP 2563A, 2565A and 2566A are dot-matrix impact printers. They connect to an HP-IB interface, and include installation by an HP Customer Engineer.

## Support

The HP 2563A printer is supported on all Series 200 and Series 300 computers. The HP 2565A and 2566A printers are supported on Series 200 Model 220 and 237 computers.

Operating/Language system support is as follows:

- **BASIC:** supported on revision 2.0 or later with Series 200 computers; supported on revision 4.0 or later on Series 300 computers. The CIPER HP-IB interface is not supported.
- **Pascal Workstation:** supported on revision 2.0 or later with Series 200 computers; supported on revision 3.1 or later with Series 300 computers. The CIPER HP-IB interface is not supported.
- **HP-UX Operating System:** supported on revision 2.1 with Series 200 computers (5.1 for the CIPER HP-IB interface); supported on revision 5.0 with Series 300 computers.

## Before You Begin

The HP 2563A, 2565A and 2566A printers are installed by an HP Customer Engineer. Make arrangements for installation with your nearest HP Sales and Service office.

The following procedure describes how to connect the HP 2563A, 2565A or 2566A printer to your Series 200/300 computer. Before you do this, however, refer to the manual(s) that came with your printer to:

- Load the ribbon cartridge.
- Load and adjust paper.
- Set the printer configuration.

# HP 2563/65/66A Printer Installation Procedure

## 1. Play It Safe.

- a. Contact your HP Customer Engineer to have your printer installed. Installation is included in the price of the printer.
- b. Turn your computer and printer off, if they are not already off.

## 2. Select Your Interface.

- a. **If you have an Option 200 (non-CIPER) Printer:** Use either the built-in HP-IB interface or an HP 98624A HP-IB Interface. If using HP-UX, avoid placing the printer on the same interface used by your disc or tape drives, if possible. If using the Pascal Workstation, select the built-in HP-IB interface.
- b. **If you have an Option 850 (CIPER) Printer:** Use either the built-in HP-IB interface or an HP 98624A HP-IB Interface.

## 3. Connect the Printer to the Computer.

- a. Find the HP-IB cable provided with the printer.
- b. Connect one end of the HP-IB cable to the HP-IB connector on the back of the printer. Tighten the thumb screws to secure the connection.
- c. Connect the other end of the HP-IB cable to the interface.

---

### NOTE

If the interface already has several cables connected to it, connect the printer's cable to one of the other devices on the interface.

---

## 4. Connect the Power Cord.

- a. Connect the female end of the power cord to the power socket on the back of the printer, and connect the other end to your power outlet.

## 5. Set the Address.

- a. Turn your printer on.
- b. Press the ON LINE key until the ON LINE indicator light turns off.
- c. Press the CONFIG key and the FINE ADJ. keys simultaneously until the number 20 appears in the display, then release them.
- d. The current address will appear in the display. Set the address as follows:
  - If this is the first (or only) printer you are connecting to the interface, press the FINE ADJ. key until the number 1 appears in the display, unless address 1 has been used elsewhere. The Pascal Workstation *expects* to find the printer at address 1.
  - If this is the second printer you are connecting to the interface, press the FINE ADJ. key until the number 4 appears in the display, unless address 4 has been used elsewhere. If it has, select any unused address.
- e. Press the ENTER key to enter the new address and return the printer to normal operation.

## 6. Record the Address.

- a. Make a note that address 1 (or the alternate address you chose in step 5) has been used and is no longer available on the interface you selected. Use the “Address Record” form on the Step 6 tab for this purpose.

---

## The Next Step

You have now installed your HP 2563A, 2565A or 2566A Printer.

The following “Worksheet Entries” contain information needed to use your printer with various language/operating systems. Refer to the entries for the system you’ll be using (BASIC, Pascal or HP-UX).

Copy this information to a worksheet (worksheets are found at the end of Step 1) or remember to refer here when you need it.

When finished, you’ll be ready to install your next peripheral.



---

## BASIC System Worksheet Entries

HP 2563/65/66A Connected to Built-in HP-IB Interface (Select Code 7)

Device Name	Device Selector <sup>1</sup>
HP 2563/65/66A	70 $n$

HP 2563/65/66A Connected to HP 98624A HP-IB Interface (Select Code 8)

Device Name	Device Selector <sup>1</sup>
HP 2563/65/66A	80 $n$

---

## Pascal Workstation Worksheet Entry

---

### NOTE

The Pascal Workstation expects to find the printer on the built-in HP-IB interface at address 1. If you did not set up your printer this way, you must make some modifications to the Pascal Workstation. See the “Special Configurations” section of the *Pascal Workstation System* manual for details.

---

Device Name	Unit Number
HP 2563/65/66A	#6:

---

<sup>1</sup>  $n$  is a number that identifies the address (set in step 5 of the Installation Procedure). Replace  $n$  with a 1 if the address was set to 1, use 4 if the address was set to 4, and so on.

---

## HP-UX System Worksheet Entries

### HP 2563/65/66A Connected to Built-in HP-IB Interface (Select Code 7)

Device Name	Path <sup>1</sup> Name	File Type	Major Number	Minor <sup>2</sup> Number
HP 2563/65/66A Opt. 200 non-CIPER	<i>/dev/lp2563</i>	c	7	0x070n00
HP 2563/65/66A Opt. 200 non-CIPER	<i>/dev/rlp2563</i>	c	7	0x070n01
HP 2563/65/66A Opt. 850 CIPER	<i>/dev/lp2563</i>	c	26	0x070n00
HP 2563/65/66A Opt. 850 CIPER	<i>/dev/rlp2563</i>	c	26	0x070n01

### HP 2563/65/66A Connected to HP 98624 HP-IB Interface (Select Code 8)

Device Name	Path <sup>1</sup> Name	File Type	Major Number	Minor <sup>2</sup> Number
HP 2563/65/66A Opt. 200 non-CIPER	<i>/dev/lp2563</i>	c	7	0x080n00
HP 2563/65/66A Opt. 200 non-CIPER	<i>/dev/rlp2563</i>	c	7	0x080n01
HP 2563/65/66A Opt. 850 CIPER	<i>/dev/lp2563</i>	c	26	0x080n00
HP 2563/65/66A Opt. 850 CIPER	<i>/dev/rlp2563</i>	c	26	0x080n01

---

<sup>1</sup> If you have an HP 2565A or HP 2566A, substitute *2565* or *2566* for *2563* in the path name.

<sup>2</sup> *n* is a number that identifies the address (set in step 5 of the Installation Procedure). Replace *n* with a 1 if the address was set to 1, use 4 if the address was set to 4, and so on.

---

# Installing the HP 2601A Printer

## Description

The HP 2601 is a Daisywheel printer that connects to an RS-232C interface.

## Support

The HP 2601A printer is supported on all Series 200 computers.

Operating/Language system support is as follows:

- **BASIC:** supported on revision 1.0 or later with Series 200 computers.
- **Pascal Workstation:** supported on revision 2.1 or later with Series 200 computers.
- **HP-UX Operating System:** not supported.

## Before You Begin

The following procedure describes how to connect your HP 2601A printer to your Series 200 computer. Before you do this, however, refer to the manual(s) that came with your printer to:

- Unpack the printer.
- Install the platen (if necessary).
- Install a print wheel.
- Install a ribbon cartridge.
- Set the Print Wheel Select switch.
- Set the Spacing Select switch.
- Set the Left DIP switch module.

# HP 2601A Printer Installation Procedure

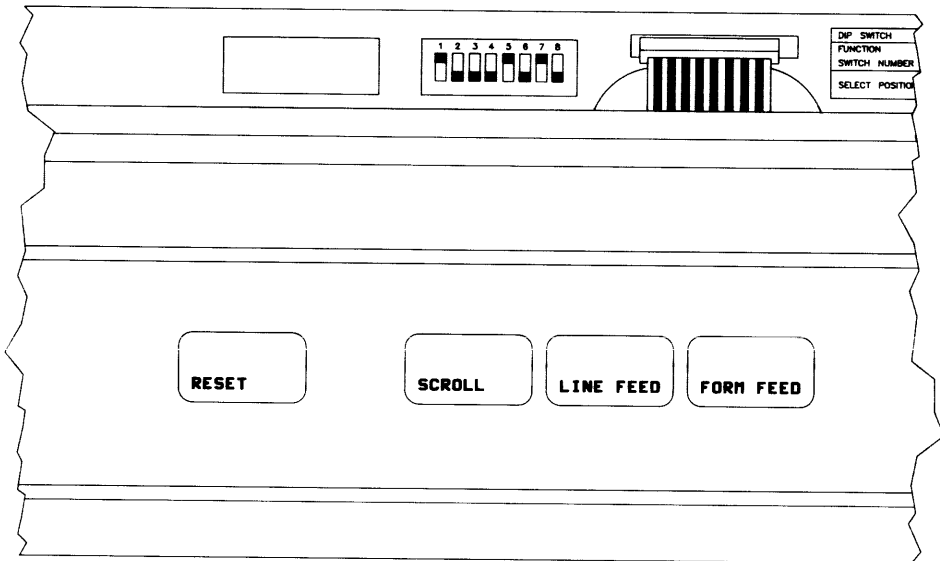

**Figure 7-1. HP 2601A Printer Switch Settings.**

## 1. Play It Safe.

- a. Turn your computer and printer off, if they are not already off.

## 2. Select Your Interface.

- a. Use any one of the following RS-232C interfaces:
  - The built-in “Data Communications” interface in a Model 216 or Model 217 computer<sup>1</sup>
  - HP 98626A RS-232C Interface
  - HP 98628A Datacomm Interface
  - HP 98644A RS-232C Serial Interface

<sup>1</sup> Configuration of this interface is not covered in this guide. Refer to the computer's *Installation Manual* to set the baud rate switches to 1200 baud (switch 1 to OPEN, switches 2, 3 and 4 to not-OPEN). The remaining switches are preset to the correct values for the HP 2601; check them only if you have changed them.

### 3. Set the Printer's Switches.

- a. Lift the printer's top cover and locate the Right DIP Switch module (see Figure 7-1). Set the switches to match those shown in Figure 7-1:
  - Set switch 1 to ON, Full Duplex.
  - Set switch 2 to OFF, Parity Disabled.
  - Set switches 3 and 5 to OFF and ON, respectively, to provide 1200 baud.
  - The other switch settings do not matter.

### 4. Connect the Printer to the Computer.

- a. Connect one (male) end of the printer's cable (usually an HP 17255D) to the connector on the back of the printer. Lock the connector in place with the screws.
- b. Connect the HP 5061-4215 DTE cable (built-in, HP 98626A and 98628A Interfaces), or the HP 13242N, 92218A or 92222M cable (HP 98644A Interface) to the interface.
- c. Connect the other end of the printer's cable to the cable connected to the interface.

### 6. Connect the Power Cord.

- a. Connect the female end of the power cord to the power socket on the back of the printer, and connect the other end to your power outlet.

---

## The Next Step

You have now installed your HP 2601A Printer.

The following "Worksheet Entries" contain information needed to use your printer with various language/operating systems. Refer to the entries for the system you'll be using (BASIC or Pascal).

Copy this information to a worksheet (worksheets are found at the end of Step 1) or remember to refer here when you need it.

When finished, you'll be ready to install your next peripheral.

---

# BASIC System Worksheet Entry

---

## IMPORTANT!

If you have connected the HP 2601A printer to an HP 98644A RS-232C Serial Interface, execute the following statement before using the printer to set the baud rate of the interface to 1200:

`CONTROL 9,13;1200`

This statement assumes an interface select code of 9. If your select code is different, substitute your select code for 9 in the statement above.

---

Device Name	Device Selector <sup>1</sup>
HP 2601A	9

---

# Pascal Workstation Worksheet Entry

---

## NOTE

Before you can use the HP 2601A printer with the Pascal Workstation, you must make a few modifications. See the "Special Configurations" chapter of the *Pascal Workstation System* manual for instructions.

---

Device Name	Unit Number
HP 2601A	#6:

---

<sup>1</sup> If you connected the HP 2601A to an interface with a select code other than 9, write in your select code instead of 9.

---

# Installing the HP 2602A Printer

## Description

The HP 2602A is a Daisywheel printer that connects to an HP-IB interface.

## Support

The HP 2602A printer is supported on all Series 200 computers.

Operating/Language system support is as follows:

- **BASIC:** supported on revision 1.0 or later with Series 200 computers.
- **Pascal Workstation:** supported on revision 2.1 or later with Series 200 computers.
- **HP-UX Operating System:** not supported

## Before You Begin

The following procedure describes how to connect your HP 2602A printer to your Series 200 computer. Before you do this, however, refer to the manual(s) that came with your printer to:

- Unpack the printer.
- Install the platen.
- Install a ribbon cartridge.
- Install a daisywheel.

## HP 2602A Printer Installation Procedure

### 1. Play It Safe.

- a. Turn your computer and printer off, if they are not already off.

### 2. Select Your Interface.

- a. Use either the built-in HP-IB interface or an HP 98624A HP-IB Interface. If using the Pascal Workstation, select the built-in HP-IB interface.

### 3. Set the Address.

---

#### CAN YOU SKIP THIS STEP?

If this is the first (or only) printer you are connecting to the interface, you can skip to step 4. The address is preset to 1 and need not be changed—*unless* you have changed the address of some other device on the interface to 1. The Pascal Workstation *expects* to find the printer at address 1.

---

- a. Remove the printer's top cover and locate the HP-IB Configuration switches.
- b. Set the address switches to 4, unless address 4 has been used elsewhere. To get address 4, set switch 1 to the On position by sliding it to the left, and set switches 2 and 3 to the Off position by sliding them to the right. Refer to the manual that came with the printer if you need additional switch settings.

### 4. Set the Other Switches.

- a. Remove the printer's top cover (if it is not already off) and locate the HP-IB Configuration switches.
- b. Set the Listen Always switch (4) to the Off position by sliding it to the right.
- c. Set the SRQ Enable switch (5) to the Off position by sliding it to the right.
- d. Set the Self Test switch (6) to the Off position by sliding it to the right.
- e. Set the Page Length switch (7) to 11 inches by sliding it to the right. If you have 12-inch paper, slide it to the left.
- f. Set the Single-Strike Ribbon switch (8) to single-strike by sliding it to the left. If you have a multi-strike ribbon, slide the switch to the right.



## 5. Connect the Printer to the Computer.

- a. Get an HP-IB cable.
- b. Connect one end of the HP-IB cable to the HP-IB connector on the back of the printer. Tighten the thumb screws to secure the connection.
- c. Connect the other end of the HP-IB cable to the interface.

---

### NOTE

If the interface already has several cables connected to it, connect the printer's cable to one of the other devices on the interface.

---

## 6. Connect the Power Cord.

- a. Connect the female end of the power cord to the power socket on the back of the printer, and connect the other end to your power outlet.

## 7. Record the Address.

- a. Make a note that address 1 (or the alternate address you chose in step 3) has been used and is no longer available on the interface you selected. Use the "Address Record" form on the Step 6 tab for this purpose.

---

## The Next Step

You have now installed your HP 2602A Printer.

The following "Worksheet Entries" contain information needed to use your printer with various language/operating systems. Refer to the entries for the system you'll be using (BASIC or Pascal).

Copy this information to a worksheet (worksheets are found at the end of Step 1) or remember to refer here when you need it.

When finished, you'll be ready to install your next peripheral.

---

## BASIC System Worksheet Entries

HP 2602A Connected to Built-in HP-IB Interface (Select Code 7)

Device Name	Device Selector <sup>1</sup>
HP 2602A	70n

HP 2602A Connected to HP 98624A HP-IB Interface (Select Code 8)

Device Name	Device Selector <sup>1</sup>
HP 2602A	80n

---

## Pascal Workstation Worksheet Entry

---

### NOTE

The Pascal Workstation expects to find the printer on the built-in HP-IB interface at address 1. If you did not set up your printer this way, you must make some modifications to the Pascal Workstation. See the "Special Configurations" section of the *Pascal Workstation System* manual for details.

---

Device Name	Unit Number
HP 2602A	#6:

---

<sup>1</sup> *n* is a number that identifies the address (set in step 3 of the Installation Procedure). Replace *n* with a 1 if the address was set to 1, use 4 if the address was set to 4, and so on.

---

# Installing the HP 2608S Printer

## Description

The HP 2608S Opt. 290 is a 400 line-per-minute, dot-matrix impact printer for fan-fold, single- or multi-part paper.

## Support

The HP 2608S Printer is supported on Series 200 Model 200, 226, 236 and 237 computers.

Operating/Language system support is as follows:

- **BASIC:** not supported.
- **Pascal Workstation:** not supported.
- **HP-UX Operating System:** supported on revision 5.1 with Series 200 computers.

## Before You Begin

The following procedure describes how to connect the HP 2608S Printer to your Series 200 computer. Before you do this, however, refer to the manual(s) that came with your printer to:

- Unpack the printer.

## HP 2608S Printer Installation Procedure

### 1. Play It Safe.

- a. Turn your computer and printer off, if they are not already off.

### 2. Select Your Interface.

- a. Use either the built-in HP-IB interface or an HP 98624A HP-IB Interface.

### 3. Set the Address.

- a. Find the five DEVICE ADDRESS switches on the back of the printer, near the HP-IB connector.
- b. Set the DEVICE ADDRESS switches as follows:
  - If the HP 2608S is the first (or only) printer you are connecting to the interface, set the switches to address 1 as shown below, unless address 1 has been used elsewhere.

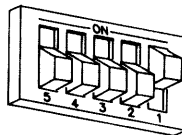

**Address 1**

- If the HP 2608S is the second printer you are connecting to the interface, set the switches to address 4 as shown below, unless address 4 has been used elsewhere. Refer to the manual that came with the printer for additional switch settings.

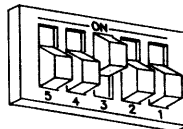

**Address 4**

#### 4. **Connect the Printer to the Computer.**

- a. Get an HP-IB cable.
- b. Connect one end of the HP-IB cable to the HP-IB connector on the back of the printer. Tighten the thumb screws to secure the connection.
- c. Connect the other end of the HP-IB cable to the interface.

---

#### **NOTE**

If the interface already has several cables connected to it, connect the printer's cable to one of the other devices on the interface.

---

#### 5. **Connect the Power Cord.**

- a. Connect the female end of the power cord to the power socket on the back of the printer, and connect the other end to your power outlet.

#### 6. **Record the Address.**

- a. Make a note that address 1 (or the alternate address you chose in step 3) has been used and is no longer available on the interface you selected. Use the "Address Record" form on the Step 6 tab for this purpose.

### **Final Preparations**

Refer to the printer's manual to complete the following installation tasks:

- Set the Power Conditions switches.
- Load the ribbon cartridge.
- Load and adjust paper.
- Set the printer configuration.
- Adjust the forms length.
- Set the top-of-form.
- Run the printer's self-test.

---

## The Next Step

You have now installed your HP 2608S Printer.

The following “Worksheet Entries” contain information needed to use your printer with HP-UX.

Copy this information to a worksheet (worksheets are found at the end of Step 1) or remember to refer here when you need it.

When finished, you’ll be ready to install your next peripheral.

---

## HP-UX System Worksheet Entries

### HP 2608S Connected to Built-in HP-IB Interface (Select Code 7)

Device Name	Path Name	File Type	Major No.	Minor No. <sup>1</sup>
HP 2608S Opt. 850 CIPER	<i>/dev/lp2608</i>	c	26	0x070n00
HP 2608S Opt. 850 CIPER	<i>/dev/rlp2608</i>	c	26	0x070n01

### HP 2608S Connected to HP 98624 HP-IB Interface (Select Code 8)

Device Name	Path Name	File Type	Major No.	Minor No. <sup>1</sup>
HP 2608S Opt. 850 CIPER	<i>/dev/lp2608</i>	c	26	0x080n00
HP 2608S Opt. 850 CIPER	<i>/dev/rlp2608</i>	c	26	0x080n01

---

<sup>1</sup> *n* is a number that identifies the address (set in step 3 of the Installation Procedure). Replace *n* with a 1 if the address was set to 1, use 4 if the address was set to 4, and so on.

---

# Installing the HP 2671A/G Printers

## Description

The HP 2671A/G are thermal printers. They connect to your computer's HP-IB interface.

## Support

The HP 2671A/G printers are supported on all Series 200 computers.

Operating/Language system support is as follows:

- **BASIC:** supported on revision 1.0 or later with Series 200 computers.
- **Pascal Workstation:** supported on revision 1.0 or later with Series 200 computers.
- **HP-UX Operating System:** supported on revision 2.0 or later with Series 200 computers.

## Before You Begin

The following procedure describes how to connect your HP 2671A/G printer to your Series 200 computer. Before you do this, however, refer to the manual(s) that came with your printer to:

- Unpack the printer.
- Check the fuse and voltage.
- Install the paper stacker.
- Load the thermal paper.

# HP 2671A/G Printer Installation Procedure

## 1. Play It Safe.

- a. Turn your computer and printer off, if they are not already off.

## 2. Select Your Interface.

- a. Use either the built-in HP-IB interface or an HP 98624A HP-IB Interface. If using HP-UX, avoid placing the HP 2671A/G on the same interface used by your disc or tape drives, if possible. If using the Pascal Workstation, select the built-in HP-IB interface.

## 3. Set the Address.

---

### CAN YOU SKIP THIS STEP?

If this is the first (or only) printer you are connecting to the interface, you can skip to step 4. The address is preset to 1 and need not be changed—*unless* you have changed the address of some other device on the interface to 1. The Pascal Workstation *expects* to find the printer at address 1.

---

- a. Find the set of “ADDRESS” switches to the left of the HP-IB connector on the back of the printer. Switches 1 through 5 in this group determine the address.
- b. Set the “ADDRESS” switches to 4 as shown below, unless address 4 has been used elsewhere. Refer to the manual that came with the printer if you need additional switch settings.

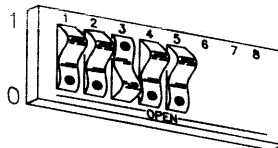

Address 4



**4. Set the Other Switches.**

- a. Set the Listen Always switch (6) to the OPEN (down) position.
- b. Set the SRQ Enable switch (7) to the not-OPEN (up) position.

**5. Connect the Printer to the Computer.**

- a. Get an HP-IB cable.
- b. Connect one end of the HP-IB cable to the HP-IB connector on the back of the printer. Tighten the thumb screws to secure the connection.
- c. Connect the other end of the HP-IB cable to the interface.

---

**NOTE**

If the interface already has several cables connected to it, connect the printer's cable to one of the other devices on the interface.

---

**6. Connect the Power Cord.**

- a. Connect the female end of the power cord to the power socket on the back of the printer, and connect the other end to your power outlet.

**7. Record the Address.**

- a. Make a note that address 1 (or the alternate address you chose in step 3) has been used and is no longer available on the interface you selected. Use the "Address Record" form on the Step 6 tab for this purpose.

---

## The Next Step

You have now installed your HP 2671A/G Printer.

The following “Worksheet Entries” contain information needed to use your printer with various language/operating systems. Refer to the entries for the system you’ll be using (BASIC, Pascal or HP-UX).

Copy this information to a worksheet (worksheets are found at the end of Step 1) or remember to refer here when you need it.

When finished, you’ll be ready to install your next peripheral.

---

## BASIC System Worksheet Entries

### HP 2671A/G Connected to Built-in HP-IB Interface (Select Code 7)

Device Name	Device Selector <sup>1</sup>
HP 2671	70 <i>n</i>

### HP 2671A/G Connected to HP 98624A HP-IB Interface (Select Code 8)

Device Name	Device Selector <sup>1</sup>
HP 2671	80 <i>n</i>

---

<sup>1</sup> *n* is a number that identifies the address (set in step 3 of the Installation Procedure). Replace *n* with a 1 if the address was set to 1, use 4 if the address was set to 4, and so on.

---

## Pascal Workstation Worksheet Entry

---

### NOTE

The Pascal Workstation expects to find the printer on the built-in HP-IB interface at address 1. If you did not set up your printer this way, you must make some modifications to the Pascal Workstation. See the “Special Configurations” section of the *Pascal Workstation System* manual for details.

---

Device Name	Unit Number
HP 2671	#6:

---

## HP-UX System Worksheet Entries

### HP 2671A/G Connected to Built-in HP-IB Interface (Select Code 7)

Device Name	Path Name	File Type	Major No.	Minor No. <sup>1</sup>
HP 2671	/dev/lp2671	c	7	0x070n00
HP 2671	/dev/rlp2671	c	7	0x070n01

### HP 2671A/G Connected to HP 98624 HP-IB Interface (Select Code 8)

Device Name	Path Name	File Type	Major No.	Minor No. <sup>1</sup>
HP 2671	/dev/lp2671	c	7	0x080n00
HP 2671	/dev/rlp2671	c	7	0x080n01

---

<sup>1</sup> *n* is a number that identifies the address (set in step 3 of the Installation Procedure). Replace *n* with a 1 if the address was set to 1, use 4 if the address was set to 4, and so on.

---

# Installing the HP 2673A Printer

## Description

The HP 2673A is an intelligent thermal graphics printer. It connects to your computer's HP-IB interface.

## Support

The HP 2673A printer is supported on all Series 200 computers.

Operating/Language system support is as follows:

- **BASIC:** supported on revision 1.0 or later with Series 200 computers.
- **Pascal Workstation:** supported on revision 1.0 or later with Series 200 computers.
- **HP-UX Operating System:** supported on revision 2.0 or later with Series 200 computers.

## Before You Begin

The following procedure describes how to connect your HP 2673A printer to your Series 200 computer. Before you do this, however, refer to the manual(s) that came with your printer to:

- Unpack the printer.
- Check the fuse and voltage.
- Install the paper stacker.
- Load the thermal paper.

## HP 2673A Printer Installation Procedure

1. **Play It Safe.**
  - a. Turn your computer and printer off, if they are not already off.
2. **Select Your Interface.**
  - a. Use either the built-in HP-IB interface or an HP 98624A HP-IB Interface. If using HP-UX, avoid placing the HP 2673A on the same interface used by your disc or tape drives, if possible. If using the Pascal Workstation, select the built-in HP-IB interface.
3. **Set the Address.**

---

### CAN YOU SKIP THIS STEP?

If this is the first (or only) printer you are connecting to the interface, you can skip to step 4. The address is preset to 1 and need not be changed— *unless* you have changed the address of some other device on the interface to 1. The Pascal Workstation *expects* to find the printer at address 1.

---

- a. The address is set with the CONFIG./EXIT button on the front of your printer. Refer to the manual that came with your printer for instructions on changing the address. Set the address to 4, unless address 4 has been used elsewhere.
4. **Connect the Printer to the Computer.**
    - a. Get an HP-IB cable.
    - b. Connect one end of the HP-IB cable to the HP-IB connector on the back of the printer. Tighten the thumb screws to secure the connection.
    - c. Connect the other end of the HP-IB cable to the interface.

---

### **NOTE**

If the interface already has several cables connected to it, connect the printer's cable to one of the other devices on the interface.

---

#### **5. Connect the Power Cord.**

- a. Connect the female end of the power cord to the power socket on the back of the printer, and connect the other end to your power outlet.

#### **6. Record the Address.**

- a. Make a note that address 1 (or the alternate address you chose in step 3) has been used and is no longer available on the interface you selected. Use the "Address Record" form on the Step 6 tab for this purpose.

---

## **The Next Step**

You have now installed your HP 2673A Printer.

The following "Worksheet Entries" contain information needed to use your printer with various language/operating systems. Refer to the entries for the system you'll be using (BASIC, Pascal or HP-UX).

Copy this information to a worksheet (worksheets are found at the end of Step 1) or remember to refer here when you need it.

When finished, you'll be ready to install your next peripheral.

---

## BASIC System Worksheet Entries

HP 2673A Connected to Built-in HP-IB Interface (Select Code 7)

Device Name	Device Selector <sup>1</sup>
HP 2673	70 $n$

HP 2673A Connected to HP 98624A HP-IB Interface (Select Code 8)

Device Name	Device Selector <sup>1</sup>
HP 2673	80 $n$

---

## Pascal Workstation Worksheet Entry

---

### NOTE

The Pascal Workstation expects to find the printer on the built-in HP-IB interface at address 1. If you did not set up your printer this way, you must make some modifications to the Pascal Workstation. See the "Special Configurations" section of the *Pascal Workstation System* manual for details.

---

Device Name	Unit Number
HP 2673	#6:

---

<sup>1</sup>  $n$  is a number that identifies the address (set in step 3 of the Installation Procedure). Replace  $n$  with a 1 if the address was set to 1, use 4 if the address was set to 4, and so on.

---

## HP-UX System Worksheet Entries

### HP 2673A Connected to Built-in HP-IB Interface (Select Code 7)

Device Name	Path Name	File Type	Major No.	Minor No. <sup>1</sup>
HP 2673	<i>/dev/lp2673</i>	c	7	0x070n00
HP 2673	<i>/dev/rtp2673</i>	c	7	0x070n01

### HP 2673A Connected to HP 98624 HP-IB Interface (Select Code 8)

Device Name	Path Name	File Type	Major No.	Minor No. <sup>1</sup>
HP 2673	<i>/dev/lp2673</i>	c	7	0x080n00
HP 2673	<i>/dev/rtp2673</i>	c	7	0x080n01

---

<sup>1</sup> *n* is a number that identifies the address (set in step 3 of the Installation Procedure). Replace *n* with a 1 if the address was set to 1, use 4 if the address was set to 4, and so on.



---

# Installing the HP 2686A/D LaserJet and HP 33440A LaserJet-II Printer

## Description

The HP 2686A/D *LaserJet* and HP 33440A *LaserJet-II* printers connect to the computer via an RS-232C interface.

## Support

The HP 2686A/D *LaserJet* printers are supported on all Series 200 and Series 300 computers. The HP 33440A *LaserJet-II* printer is supported on the Series 200 Model 226 and 236 computers, and on all Series 300 computers.

Operating/Language system support is as follows:

- **BASIC:** supported on revision 2.0 or later with Series 200 computers; supported on revision 4.0 or later with Series 300 computers.
- **Pascal Workstation:** supported on revision 2.1 or later with Series 200 computers; supported on revision 3.1 or later with Series 300 computers.
- **HP-UX Operating System:** supported on revision 2.2L or later with Series 200 computers; supported on revision 5.0 or later with Series 300 computers.

## Before You Begin

The following procedure describes how to connect your HP 2686A/D *LaserJet* or HP 33440A *LaserJet-II* printer to your Series 200/300 computer. Before you do this, however, refer to the manual(s) that came with your printer to:

- Unpack the printer.
- Install the electrophotographic (EP) cartridge.
- Install the fusing roller cleaning pad.
- Install the paper trays.
- Load the paper
- Configure the printer.

# HP 2686A/D and 33440A Installation Procedure

## 1. Play It Safe.

- a. Turn your computer and printer off, if they are not already off.

## 2. Select Your Interface.

- a. Use any one of the following RS-232C interfaces:
  - The built-in "Data Communications" interface in a Model 216 or Model 217 computer (2686A/D LaserJets only)<sup>1</sup>
  - The built-in RS-232 interface in a Series 300 computer
  - HP 98626A RS-232C Interface
  - HP 98628A Datacomm Interface
  - HP 98642A 4-Channel Multiplexer Interface (not for BASIC or Pascal)
  - HP 98644A RS-232C Serial Interface

## 3. Select Your Cable(s).

- a. Following are *some* of the possible cabling combinations you can use. Combinations other than those listed may also work.
  - **Series 300 Built-in Interface:** connect an HP 17255D to the printer if an HP 92221M or 13242N cable is connected to the interface; or connect an HP 92221P cable directly between the printer and the interface (HP-UX only).
  - **Series 200 Built-in, HP 98626A or HP 98628A Interfaces:** connect an HP 17255D cable to the printer if an HP 5061-4215 DTE cable is connected to the interface; or connect an HP 13242N or 92218A cable to the printer if an HP 5061-4216 DCE, 13232U or Modem-Modem cable is connected to the interface (HP-UX only).

---

<sup>1</sup> Configuration of this interface is not covered in this guide. Refer to the computer's *Installation Manual* to set the baud rate switches to 9600 baud (switches 1, 2 and 3 to OPEN, switch 4 to not-OPEN). If using the Pascal Workstation or HP-UX, also set the handshake type switches to XON/XOFF (switch 1 to not-OPEN, switch 2 to OPEN). The remaining switches are preset to the correct values for the HP 2686A/D; check them only if you have changed them.

- **HP 98642A Interface:** connect an HP 17255D cable to the printer if an HP 92219S, 92218A, or 92222M cable is connected to the interface (port 0); or connect an HP 13242G or 92219R cable directly between the printer and the interface (port 0); or connect an HP 92219U adaptor directly from the interface (ports 1, 2 or 3) and the printer.
- **HP 98644A Interface:** connect an HP 17255D cable to the printer if an HP 13242N, 92218A or 92222M cable is connected to the interface; or connect an HP 13242G or 92219R cable directly between the printer and the interface (HP-UX only).

#### 4. Connect the Printer to the Computer.

- a. Connect one (male) end of the printer's cable to the connector on the printer. Lock the connection in place with the screws.
- b. If your interface connection requires one or more additional cables, connect the remaining cable(s) to the interface.
- c. Connect the other end of the printer's cable either directly to the interface or to cable(s) connected to the interface.

#### 5. Connect the Power Cord.

- a. Connect the female end of the power cord to the power socket on the back of the printer, and connect the other end to your power outlet.

---

## The Next Step

You have now installed your HP 2686A/D or 33440A Printer.

The following "Worksheet Entries" contain information needed to use your printer with various language/operating systems. Refer to the entries for the system you'll be using (BASIC, Pascal or HP-UX).

Copy this information to a worksheet (worksheets are found at the end of Step 1) or remember to refer here when you need it.

When finished, you'll be ready to install your next peripheral.

---

## BASIC System Worksheet Entry

---

### NOTE

The *LaserJet* and *LaserJet-II* will wait until its buffer is full before printing a page. To force the printer to print *before* its buffer is full, execute the following statement after sending the text to be printed:

```
PRINT CHR$(12)
```

---

Device Name	Device Selector <sup>1</sup>
HP 2686A/D and 33440A	9

---

## Pascal Workstation Worksheet Entry

---

### NOTE

Before you can use the *LaserJet* or *LaserJet-II* printer with the Pascal Workstation, you must make a few modifications. See the “Special Configurations” chapter of the *Pascal Workstation System* manual for instructions on configuring the Pascal Workstation for a serial printer.

---

Device Name	Unit Number
HP 2686A/D and 33440A	#6:

---

<sup>1</sup> If you connected the HP 2686A/D or 33440A to an interface with a select code other than 9, write in your select code instead of 9.

# HP-UX System Worksheet Entries

For spooled printing, use the 2686a spooler model file. For unspooled printing, insert the following shell commands into */etc/rc*:

```
nohup sleep 2000000000 < /dev/lp2686 &
stty -parenb -ienqak cs8 9600 -cstopb -clocal ixon opost onlcr tab3 <
/dev/lp2686
```

To configure the interface for raster graphics printing, execute the following *stty* command (or equivalent *ioctl(2)* calls). Reissue the sequence above after printing raster data.

```
stty -parenb -ienqak cs8 9600 -cstopb -clocal ixon -opost < /dev/lp2686
```

## HP 2686A/D or 33440A Connected to Model 216, 217, or Series 300 Built-in Interface

Device Name	Path Name	File Type	Major No.	Minor No.
HP 2686A/D and 33440A, select code 9	<i>/dev/lp2686</i>	c	1	0x090004

## HP 2686A/D or 33440A Connected to HP 98626A, 98628A or 98644A Interface

Device Name	Path Name	File Type	Major No.	Minor No.
HP 2686A/D and 33440A, select code 9	<i>/dev/lp2686</i>	c	1	0x090004
HP 2686A/D and 33440A, select code 10	<i>/dev/lp2686</i>	c	1	0x0a0004
HP 2686A/D and 33440A, select code 15	<i>/dev/lp2686</i>	c	1	0x0f0004
HP 2686A/D and 33440A, select code 16	<i>/dev/lp2686</i>	c	1	0x100004
HP 2686A/D and 33440A, select code 17	<i>/dev/lp2686</i>	c	1	0x110004
HP 2686A/D and 33440A, select code 19	<i>/dev/lp2686</i>	c	1	0x130004
HP 2686A/D and 33440A, select code 20	<i>/dev/lp2686</i>	c	1	0x140004

---

## HP-UX System Worksheet Entries (Cont.)

### HP 2686A/D or 33440A Connected to HP 98642A Interface

Device Name	Path Name	File Type	Major No.	Minor No.
HP 2686A/D and 33440A, select code 10, port 0	<i>/dev/lp2686</i>	c	1	0x0a0004
HP 2686A/D and 33440A, select code 10, port 1	<i>/dev/lp2686</i>	c	1	0x0a0104
HP 2686A/D and 33440A, select code 10, port 2	<i>/dev/lp2686</i>	c	1	0x0a0204
HP 2686A/D and 33440A, select code 10, port 3	<i>/dev/lp2686</i>	c	1	0x0a0304
HP 2686A/D and 33440A, select code 13, port 0	<i>/dev/lp2686</i>	c	1	0x0d0004
HP 2686A/D and 33440A, select code 13, port 1	<i>/dev/lp2686</i>	c	1	0x0d0104
HP 2686A/D and 33440A, select code 13, port 2	<i>/dev/lp2686</i>	c	1	0x0d0204
HP 2686A/D and 33440A, select code 13, port 3	<i>/dev/lp2686</i>	c	1	0x0d0304
HP 2686A/D and 33440A, select code 15, port 0	<i>/dev/lp2686</i>	c	1	0x0f0004
HP 2686A/D and 33440A, select code 15, port 1	<i>/dev/lp2686</i>	c	1	0x0f0104
HP 2686A/D and 33440A, select code 15, port 2	<i>/dev/lp2686</i>	c	1	0x0f0204
HP 2686A/D and 33440A, select code 15, port 3	<i>/dev/lp2686</i>	c	1	0x0f0304
HP 2686A/D and 33440A, select code 16, port 0	<i>/dev/lp2686</i>	c	1	0x100004
HP 2686A/D and 33440A, select code 16, port 1	<i>/dev/lp2686</i>	c	1	0x100104
HP 2686A/D and 33440A, select code 16, port 2	<i>/dev/lp2686</i>	c	1	0x010204
HP 2686A/D and 33440A, select code 16, port 3	<i>/dev/lp2686</i>	c	1	0x010304
HP 2686A/D and 33440A, select code 17, port 0	<i>/dev/lp2686</i>	c	1	0x110004
HP 2686A/D and 33440A, select code 17, port 1	<i>/dev/lp2686</i>	c	1	0x110104
HP 2686A/D and 33440A, select code 17, port 2	<i>/dev/lp2686</i>	c	1	0x110204
HP 2686A/D and 33440A, select code 17, port 3	<i>/dev/lp2686</i>	c	1	0x110304
HP 2686A/D and 33440A, select code 19, port 0	<i>/dev/lp2686</i>	c	1	0x130004
HP 2686A/D and 33440A, select code 19, port 1	<i>/dev/lp2686</i>	c	1	0x130104
HP 2686A/D and 33440A, select code 19, port 2	<i>/dev/lp2686</i>	c	1	0x130204
HP 2686A/D and 33440A, select code 19, port 3	<i>/dev/lp2686</i>	c	1	0x130304

---

# Installing the HP 2932A and 2934A Printers

## Description

The HP 2930 Series of printers provide features for several levels of printer categories. However, installation for all printers in the series is common.

## Support

The HP 2932A and HP 2934A printers are supported on all Series 200 and Series 300 computers.

Operating/Language system support is as follows:

- **BASIC:** supported on revision 2.0 or later with Series 200 computers; supported on revision 4.0 or later with Series 300 computers.
- **Pascal Workstation:** supported on revision 2.0 or later with Series 200 computers; supported on revision 3.1 or later with Series 300 computers.
- **HP-UX Operating System:** supported on revision 2.0 or later with Series 200 computers; supported on revision 5.0 or later with Series 300 computers.

## Before You Begin

The following procedure describes how to connect your HP 2932A or HP 2934A printer to your Series 200/300 computer. Before you do this, however, refer to the manual(s) that came with your printer to:

- Unpack the printer.
- Check the voltage setting.
- Install the fuse.
- Install the ribbon.
- Adjust the print head gap.
- Load the paper.

## **HP 2932A and 2934A Printer Installation Procedure**

### **1. Play It Safe.**

- a. Turn your computer and printer off, if they are not already off.

### **2. Select Your Interface.**

- a. Use either the built-in HP-IB interface or an HP 98624A HP-IB Interface. If using the Pascal Workstation, select the built-in HP-IB interface.

### **3. Connect the Printer to the Computer.**

- a. Get an HP-IB cable.
- b. Connect one end of the HP-IB cable to the HP-IB connector on the back of the printer. Tighten the thumb screws to secure the connection.
- c. Connect the other end of the HP-IB cable to the interface.

---

#### **NOTE**

If the interface already has several cables connected to it, connect the printer's cable to one of the other devices on the interface.

---

### **4. Connect the Power Cord.**

- a. Connect the female end of the power cord to the power socket on the back of the printer, and connect the other end to your power outlet.



## 5. Set the Address.

---

### CAN YOU SKIP THIS STEP?

---

If this is the first (or only) printer you are connecting to the interface, you can skip to step 4. The address is preset to 1 and need not be changed—*unless* you have changed the address of some other device on the interface to 1. The Pascal Workstation *expects* to find the printer at address 1.

---

- a. Turn the printer on. The power switch is in the back above the power cord.
- b. Press the SELECT button on the top of the printer, then press the VIEW button. The printer will respond by printing its SETTINGS options.
- c. Press the right arrow button until the print head is under the MODIFY INTERFACE option (i.e., under the word “INTERFACE” on the right side of the paper).
- d. Press the SELECT button. The printer will print the MODIFY INTERFACE - HP-IB options.
- e. Press the right arrow button until the print head is under the ADDRESS option, then press the SELECT button.
- f. The printer will print a list of numbers. Press the right arrow button until the print head is under the number 4 and press the SELECT button, unless you have used address 4 elsewhere. If you have, choose any unused address.  
**Note:** If the printer asks you to select a FIRST DIGIT and a SECOND DIGIT, position the print head under 0 for the FIRST DIGIT and press the SELECT button, then position the print head under 4 for the SECOND DIGIT and press the SELECT button.
- g. Press the VIEW button to exit SETTINGS mode.

## 6. Enable the AMIGO Protocol (HP-UX Only).

---

### CAN YOU SKIP THIS STEP?

If you are using BASIC or the Pascal Workstation, you can skip to step 7. If you are using HP-UX, *and* there will be other devices on the interface besides the HP 2932/34A printer, continue with step 6.

---

- a. Turn the printer on, if it is not already on.
- b. Press the SELECT button on the top of the printer, then press the VIEW button. The printer will respond by printing its SETTINGS options.
- c. Press the right arrow button until the print head is under the MODIFY INTERFACE option (i.e., under the word "INTERFACE" on the right side of the paper).
- d. Press the SELECT button. The printer will print the MODIFY INTERFACE - HP-IB options.
- e. The print head should be under the SECONDARY COMMANDS option on the left side of the paper. If it isn't, use the arrow buttons to position the print head under that option.
- f. Press the SELECT button. The printer will print the SECONDARY COMMANDS options.
- g. Use the arrow buttons to position the print head under the "on" option and press the SELECT button. This enables the AMIGO protocol, which allows HP-UX to pace the printer (time-share the bus with other devices on the interface) if the printer's address is in the range 0 to 7.
- h. Press the VIEW button to exit SETTINGS mode.

## 7. Record the Address.

- a. Make a note that address 1 (or the alternate address you chose in step 5) has been used and is no longer available on the interface you selected. Use the "Address Record" form on the Step 6 tab for this purpose.

## Final Preparations

Refer to your printer's manual(s) to:

- Set print margins.
- Run the printer's self-test

---

## The Next Step

You have now installed your HP 2932/34A Printer.

The following "Worksheet Entries" contain information needed to use your printer with various language/operating systems. Refer to the entries for the system you'll be using (BASIC, Pascal or HP-UX).

Copy this information to a worksheet (worksheets are found at the end of Step 1) or remember to refer here when you need it.

When finished, you'll be ready to install your next peripheral.

---

## BASIC System Worksheet Entries

### HP 2932/34A Connected to Built-in HP-IB Interface (Select Code 7)

Device Name	Device Selector <sup>1</sup>
HP 2932/34A	70 <i>n</i>

### HP 2932/34A Connected to HP 98624A HP-IB Interface (Select Code 8)

Device Name	Device Selector <sup>1</sup>
HP 2932/34A	80 <i>n</i>

---

<sup>1</sup> *n* is a number that identifies the address (set in step 5 of the Installation Procedure). Replace *n* with a 1 if the address was set to 1, use 4 if the address was set to 4, and so on.

---

## Pascal Workstation Worksheet Entry

---

### NOTE

The Pascal Workstation expects to find the printer on the built-in HP-IB interface at address 1. If you did not set up your printer this way, you must make some modifications to the Pascal Workstation. See the "Special Configurations" section of the *Pascal Workstation System* manual for details.

---

Device Name	Unit Number
HP 2932/34A	#6:

---

## HP-UX System Worksheet Entries

HP 2932/34A Connected to Built-in HP-IB Interface (Select Code 7)

Device Name	Path Name <sup>1</sup>	File Type	Major No.	Minor No. <sup>2</sup>
HP 2932/34A	/dev/lp2932	c	7	0x070n00
HP 2932/34A	/dev/rlp2932	c	7	0x070n01

HP 2932/34A Connected to HP 98624 HP-IB Interface (Select Code 8)

Device Name	Path Name <sup>1</sup>	File Type	Major No.	Minor No. <sup>2</sup>
HP 2932/34A	/dev/lp2932	c	7	0x080n00
HP 2932/34A	/dev/rlp2932	c	7	0x080n01

---

<sup>1</sup> If you have an HP 2934A, substitute *2934* for *2932* in the path name.

<sup>2</sup> *n* is a number that identifies the address (set in step 5 of the Installation Procedure). Replace *n* with a 1 if the address was set to 1, use 4 if the address was set to 4, and so on.

---

# Installing the HP 82905B and 82906A Printers

## Description

The HP 82905B and HP 82906A are dot-matrix impact printers using the HP-IB interface.

## Support

The HP 82905B and HP 82906A printers are supported on all Series 200 and Series 300 computers.

Operating/Language system support is as follows:

- **BASIC:** supported on revision 1.0 or later with Series 200 computers; supported on revision 4.0 or later on Series 300 computers.
- **Pascal Workstation:** supported on revision 2.0 or later with Series 200 computers; only the HP 82906A is supported on revision 3.1 or later with Series 300 computers.
- **HP-UX Operating System:** the HP 82905B is not supported; the HP 82906A is supported on revision 2.0 or later with Series 200 computers, and supported on revision 5.0 or later with Series 300 computers.

## Before You Begin

The following procedure describes how to connect your HP 82905B or HP 82906A printer to your Series 200/300 computer. Before you do this, however, refer to the manual(s) that came with your printer to:

- Unpack the printer.
- Remove protective paper (HP 82906A only).
- Remove shipping screws (HP 82905B only).
- Install the ribbon cartridge.
- Install the paper separator.
- Load the paper.
- Set the top-of-form.
- Adjust the print head gap.

## HP 82905B and 82906A Printer Installation Procedure

### 1. Play It Safe.

- a. Turn your computer and printer off, if they are not already off.

### 2. Select Your Interface.

- a. Use either the built-in HP-IB interface or an HP 98624A HP-IB Interface. If using HP-UX, avoid placing the HP 82906A on the same interface used by your disc or tape drives, if possible. If using the Pascal Workstation, select the built-in HP-IB interface.

### 3. Set the Address.

---

#### CAN YOU SKIP THIS STEP?

If this is the first (or only) printer you are connecting to the interface, you can skip to step 4. The address is preset to 1 and need not be changed—*unless* you have changed the address of some other device on the interface to 1. The Pascal Workstation *expects* to find the printer at address 1.

---

- a. The address switches are hidden under the top cover of the printer. Refer to the printer manual to find them.
- b. Set the address switches to 4 as shown below, unless address 4 has been used elsewhere. Refer to the manual that came with the printer if you need additional switch settings.

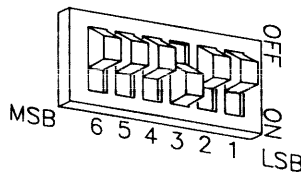

Address 4

#### 4. **Connect the Printer to the Computer.**

- a. Get an HP-IB cable.
- b. Connect one end of the HP-IB cable to the HP-IB connector on the back of the printer. Tighten the thumb screws to secure the connection.
- c. Connect the other end of the HP-IB cable to the interface.

---

#### **NOTE**

If the interface already has several cables connected to it, connect the printer's cable to one of the other devices on the interface.

---

#### 5. **Connect the Power Cord.**

- a. Connect the female end of the power cord to the power socket on the back of the printer, and connect the other end to your power outlet.

#### 6. **Record the Address.**

- a. Make a note that address 1 (or the alternate address you chose in step 3) has been used and is no longer available on the interface you selected. Use the "Address Record" form on the Step 6 tab for this purpose.

---

## **The Next Step**

You have now installed your HP 82905B or 82906A Printer.

The following "Worksheet Entries" contain information needed to use your printer with various language/operating systems. Refer to the entries for the system you'll be using (BASIC, Pascal or HP-UX).

Copy this information to a worksheet (worksheets are found at the end of Step 1) or remember to refer here when you need it.

When finished, you'll be ready to install your next peripheral.

---

## BASIC System Worksheet Entries

HP 82905B/82906A Connected to Built-in HP-IB Interface (Select Code 7)

Device Name	Device Selector <sup>1</sup>
HP 82905B/82906A	70 $n$

HP 82905B/82906A Connected to HP 98624A HP-IB Interface (Select Code 8)

Device Name	Device Selector <sup>1</sup>
HP 82905B/82906A	80 $n$

---

## Pascal Workstation Worksheet Entry

---

### NOTE

The Pascal Workstation expects to find the printer on the built-in HP-IB interface at address 1. If you did not set up your printer this way, you must make some modifications to the Pascal Workstation. See the "Special Configurations" section of the *Pascal Workstation System* manual for details.

---

Device Name	Unit Number
HP 82905B/82906A	#6:

---

<sup>1</sup>  $n$  is a number that identifies the address (set in step 3 of the Installation Procedure). Replace  $n$  with a 1 if the address was set to 1, use 4 if the address was set to 4, and so on.



---

## HP-UX System Worksheet Entries

### HP 82906A Connected to Built-in HP-IB Interface (Select Code 7)

Device Name	Path Name	File Type	Major No.	Minor No. <sup>1</sup>
HP 82906A	<i>/dev/lp82906</i>	c	7	0x070n00
HP 82906A	<i>/dev/lp82906</i>	c	21	0x070n00

### HP 82906A Connected to HP 98624 HP-IB Interface (Select Code 8)

Device Name	Path Name	File Type	Major No.	Minor No. <sup>1</sup>
HP 82906A	<i>/dev/lp82906</i>	c	7	0x080n00
HP 82906A	<i>/dev/rlp82906</i>	c	21	0x080n00

---

<sup>1</sup> *n* is a number that identifies the address (set in step 3 of the Installation Procedure). Replace *n* with a 1 if the address was set to 1, use 4 if the address was set to 4, and so on.

---

# Installing the HP 9876A Printer

## Description

The HP 9876A is a thermal graphics printer that connects to the computer via an HP-IB interface.

## Support

The HP 9876A printer is supported on all Series 200 and Series 300 computers.

Operating/Language system support is as follows:

- **BASIC:** supported on revision 1.0 or later with Series 200 computers.
- **Pascal Workstation:** supported on revision 1.0 or later with Series 200 computers.
- **HP-UX Operating System:** supported on revision 2.0 or later with Series 200 computers; not supported on Series 300 computers.

## Before You Begin

The following procedure describes how to connect your HP 9876A printer to your Series 200/300 computer. Before you do this, however, refer to the manual(s) that came with your printer to:

- Unpack the printer.
- Check the AC LINE setting and fuse.
- Load the paper.

# HP 9876A Printer Installation Procedure

## 1. Play It Safe.

- a. Turn your computer and printer off, if they are not already off.

## 2. Select Your Interface.

- a. Use either the built-in HP-IB interface or an HP 98624A HP-IB Interface. If using HP-UX, avoid placing the HP 9876A on the same interface used by your disc or tape drives, if possible. If using the Pascal Workstation, select the built-in HP-IB interface.

## 3. Set the Address.

---

### CAN YOU SKIP THIS STEP?

If this is the first (or only) printer you are connecting to the interface, you can skip to step 4. The address is preset to 1 and need not be changed—*unless* you have changed the address of some other device on the interface to 1. The Pascal Workstation *expects* to find the printer at address 1.

---

- a. Find the set of switches to the right of the HP-IB connector on the back of the printer. Switches A1 through A5 in this group determine the address.
- b. Set the address switches to 4 as shown below, unless address 4 has been used elsewhere. Refer to the manual that came with the printer if you need additional switch settings.

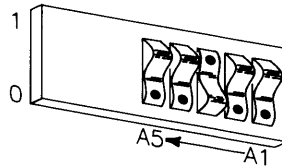

Address 4

#### 4. **Connect the Printer to the Computer.**

- a. Get an HP-IB cable.
- b. Connect one end of the HP-IB cable to the HP-IB connector on the back of the printer. Tighten the thumb screws to secure the connection.
- c. Connect the other end of the HP-IB cable to the interface.

---

#### **NOTE**

If the interface already has several cables connected to it, connect the printer's cable to one of the other devices on the interface.

---

#### 5. **Connect the Power Cord.**

- a. Connect the female end of the power cord to the power socket on the back of the printer, and connect the other end to your power outlet.

#### 6. **Record the Address.**

- a. Make a note that address 1 (or the alternate address you chose in step 3) has been used and is no longer available on the interface you selected. Use the "Address Record" form on the Step 6 tab for this purpose.

---

## **The Next Step**

You have now installed your HP 9876A Printer.

The following "Worksheet Entries" contain information needed to use your printer with various language/operating systems. Refer to the entries for the system you'll be using (BASIC, Pascal or HP-UX).

Copy this information to a worksheet (worksheets are found at the end of Step 1) or remember to refer here when you need it.

When finished, you'll be ready to install your next peripheral.

---

## BASIC System Worksheet Entries

HP 9876A Connected to Built-in HP-IB Interface (Select Code 7)

Device Name	Device Selector <sup>1</sup>
HP 9876A	70 $n$

HP 9876A Connected to HP 98624A HP-IB Interface (Select Code 8)

Device Name	Device Selector <sup>1</sup>
HP 9876A	80 $n$

---

## Pascal Workstation Worksheet Entry

---

### NOTE

The Pascal Workstation expects to find the printer on the built-in HP-IB interface at address 1. If you did not set up your printer this way, you must make some modifications to the Pascal Workstation. See the "Special Configurations" section of the *Pascal Workstation System* manual for details.

---

Device Name	Unit Number
HP 9876A	#6:

---

<sup>1</sup>  $n$  is a number that identifies the address (set in step 3 of the Installation Procedure). Replace  $n$  with a 1 if the address was set to 1, use 4 if the address was set to 4, and so on.

---

## HP-UX System Worksheet Entries

### HP 9876A Connected to Built-in HP-IB Interface (Select Code 7)

Device Name	Path Name	File Type	Major No.	Minor No. <sup>1</sup>
HP 9876A	<i>/dev/lp9876</i>	c	7	0x070n00
HP 9876A	<i>/dev/rtp9876</i>	c	7	0x070n01

### HP 9876A Connected to HP 98624 HP-IB Interface (Select Code 8)

Device Name	Path Name	File Type	Major No.	Minor No. <sup>1</sup>
HP 9876A	<i>/dev/lp9876</i>	c	7	0x080n00
HP 9876A	<i>/dev/rtp9876</i>	c	7	0x080n01

---

<sup>1</sup> *n* is a number that identifies the address (set in step 3 of the Installation Procedure). Replace *n* with a 1 if the address was set to 1, use 4 if the address was set to 4, and so on.

# Adding Plotters & Other Graphics Devices

# 8

If you need to install any of the products listed below, turn to the indicated page number and follow the instructions. Otherwise, go to Step 9.

Product Name	Page Number
HP 7440A Plotter (Option 002)	See page 8-2
HP 7470A Plotter (Option 002)	See page 8-2
HP 7475A Plotter (Option 002)	See page 8-2
HP 7510 Color Film Recorder	See page 8-10
HP 7550A Plotter	See page 8-2
HP 7570A Plotter (with 17570A)	See page 8-2
HP 7580B Plotter	See page 8-2
HP 7585B Plotter	See page 8-2
HP 7586B Plotter	See page 8-2
HP 7595A Plotter	See page 8-2
HP 7596A Plotter	See page 8-2
HP 9111A Graphics Tablet	See page 8-14
HP 98700 Graphics Display Station	See page 8-20
HP 98720A Graphics Display Station	See page 8-30
HP 9872C/T Plotter	See page 8-2
HP 13279B Color Monitor	See page 8-26

---

## NOTE

All HP-HIL graphics devices are covered in Step 10. Graphics terminals and monitors are covered in Step 9. Graphics printers are covered in Step 7.

---

---

## Installing a Plotter (HP-IB Interface)

### Description

All HP plotters connect to your computer's HP-IB interface in the same fashion. The following procedure describes how to install the following plotters:

- HP 7440A (Option 002)
- HP 7470A (Option 002)
- HP 7475A (Option 002)
- HP 7550A
- HP 7570A (with 17570A)
- HP 7580B
- HP 7585B
- HP 7586B
- HP 7595A
- HP 7596A
- HP 9872C/T

### Support

All plotters listed above are supported on all Series 200 computers, with the following exceptions:

- The HP 7570A (with 17570A accessory) is supported on Model 220, 226, 236 and 237 computers.
- The HP 7595A is supported on Model 226 and 236 computers.
- The HP 7596A is supported on Model 226 and 236 computers.

All plotters listed above are supported on all Series 300 computers, with the following exceptions:

- The HP 7570A (using the 17570A accessory card) is not yet supported but was under investigation at the time this manual went to print.



Operating/Language system support is as follows:

- **BASIC:**

- The HP 7470A, HP 7475A and the HP 7550A are supported on revision 2.1 or later with Series 200 computers; supported on revision 4.0 or later with Series 300 computers.
- The HP 7580B, HP 7585B, HP 7586B, and HP 9872C/T are supported on revision 2.0 or later with Series 200 computers; supported on revision 4.0 or later with Series 300 computers.
- The HP 7440A is supported on revision 3.0 or later with Series 200 computers; supported on revision 4.0 or later with Series 300 computers.
- The HP 7570A is supported on revision 4.0 or later with Series 200 computers.
- The HP 7595A and HP 7596A are supported on revision 5.0 or later with Series 200 computers; supported on revision 5.0 or later with Series 300 computers.

- **Pascal Workstation:**

- The HP 7470A, HP 7475A, HP 7550A, and HP 7586B are supported on revision 2.1 or later with Series 200 computers; supported on revision 3.1 or later with Series 300 computers.
- The HP 7580B, HP 7585B and HP 9872C/T are supported on revision 2.0 or later with Series 200 computers; supported on revision 3.1 or later with Series 300 computers.
- The HP 7440A is supported on revision 3.0 or later with Series 200 computers; supported on revision 3.1 or later with Series 300 computers.
- The HP 7595A and HP 7596A are supported on revision 3.1 or later with Series 300 computers.

- **HP-UX Operating System:**

- The HP 7470A, HP 7580B, HP 7585B and HP 9872C/T are supported on revision 2.0 or later with Series 200 computers; supported on revision 5.0 or later with Series 300 computers.
- The HP 7475A, HP 7550A and HP 7586B are supported on revision 2.1 or later with Series 200 computers; supported on revision 5.0 or later with Series 300 computers.

- The HP 7440A is supported on revision 5.1 or later with Series 200 computers; supported on revision 5.0 or later with Series 300 computers.
- The HP 7570A is supported on revision 5.1 or later with Series 200 computers; supported on revision 5.1 or later with Series 300 computers.
- The HP 7595A and HP 7596A are supported on revision 5.2 or later with Series 300 computers.

## **Before You Begin**

The following procedure describes how to connect your plotter to your Series 200/300 computer. Before you do this, however, refer to the manual(s) that came with your printer to:

- Unpack the plotter.
- Check the line voltage.

## Plotter Installation Procedure

### 1. Play It Safe.

- a. Turn your computer and plotter off, if they are not already off.

### 2. Select Your Interface.

- a. Use either the built-in HP-IB interface or an HP 98624A HP-IB Interface. If using HP-UX, avoid placing the plotter on the same interface used by your disc or tape drives, if possible. A dedicated HP 98624A HP-IB Interface is recommended.

### 3. Set the Address.

---

#### CAN YOU SKIP THIS STEP?

If this is the first (or only) plotter you are connecting to the interface, you can skip to step 4. The address is preset to 5 and need not be changed—*unless* you have changed the address of some other device on the interface to 5.

---

- a. Find the set of five HP-IB address switches near the HP-IB connector.
- b. Set the address switches to 7 as shown below, unless address 7 has been used elsewhere. Refer to the manual that came with the plotter if you need additional switch settings.

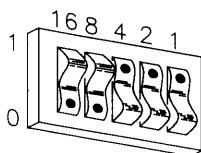

**Address 7**

### 4. Connect the Plotter to the Computer.

- a. Get an HP-IB cable.
- b. Connect one end of the HP-IB cable to the HP-IB connector on the back of the plotter. Tighten the thumb screws to secure the connection.

- c. Connect the other end of the HP-IB cable to the interface.

---

**NOTE**

If the interface already has several cables connected to it, connect the plotter's cable to one of the other devices on the interface.

---

**5. Connect the Power Cord.**

- a. Connect the female end (the small end if using an HP 7440A) of the power cord to the power socket on the back of the plotter, and connect the other end to your power outlet.

**6. Record the Address.**

- a. Make a note that address 5 (or the alternate address you chose in step 3) has been used and is no longer available on the interface you selected. Use the "Address Record" form on the Step 6 tab for this purpose.

## **Final Preparations**

Refer to your plotter's manual(s) to:

- Load the pens.
- Load the paper or medium.
- Perform the Confidence Test.

---

## **The Next Step**

You have now installed your plotter.

The following "Worksheet Entries" contain information needed to use your plotter with various language/operating systems. Refer to the entries for the system you'll be using (BASIC, Pascal or HP-UX).

Copy this information to a worksheet (worksheets are found at the end of Step 1) or remember to refer here when you need it.

When finished, you'll be ready to install your next peripheral.

---

## BASIC System Worksheet Entries

Plotter Connected to Built-in HP-IB Interface (Select Code 7)

Device Name	Device Selector <sup>1</sup>	Display/Plotter Spec.
Plotter	70 <i>n</i>	"HPGL"

Plotter Connected to HP 98624A HP-IB Interface (Select Code 8)

Device Name	Device Selector <sup>1</sup>	Display/Plotter Spec.
Plotter	80 <i>n</i>	"HPGL"

---

## Pascal Workstation Worksheet Entries

Plotter Connected to Built-in HP-IB Interface (Select Code 7)

Device Name	Device Selector <sup>1</sup>
Plotter	70 <i>n</i>

Plotter Connected to HP 98624A HP-IB Interface (Select Code 8)

Device Name	Device Selector <sup>1</sup>
Plotter	80 <i>n</i>

---

<sup>1</sup> *n* is a number that identifies the address (set in step 3 of the Installation Procedure). Replace *n* with a 5 if the address was set to 5, use 7 if the address was set to 7, and so on.

---

## HP-UX System Worksheet Entries

### Plotter Connected to Built-in HP-IB Interface (Select Code 7)

Device Name	Path Name <sup>1</sup>	File Type	Major No.	Minor No. <sup>2</sup>
Plotter	<i>/dev/pl<sup>n</sup>7440</i>	c	21	0x070n00

### Plotter Connected to HP 98624 HP-IB Interface (Select Code 8)

Device Name	Path Name <sup>1</sup>	File Type	Major No.	Minor No. <sup>2</sup>
Plotter	<i>/dev/pl<sup>n</sup>7440</i>	c	21	0x080n00

---

<sup>1</sup> If you have a plotter other than the HP 7440A, substitute the model number of your plotter for 7440 in the path name.

<sup>2</sup> *n* is a number that identifies the address (set in step 3 of the Installation Procedure). Replace *n* with a 5 if the address was set to 5, use 7 if the address was set to 7, and so on.

---

# Installing an HP 7510 Color Film Recorder

## Description

The HP 7510 Color Film Recorder lets you create high-quality, 35-mm color slides for business and technical presentations. It also produces instant Poloroid prints with the same high resolution.

## Support

The HP 7510 is supported on Series 200 Model 226 and 236 computers. Support for other Series 200 computers, and for all Series 300 computers, is planned but was not authorized at the time of printing.

Operating/Language system support is as follows:

- **BASIC:** supported on revision 4.0 or later on Series 200 computers.
- **Pascal Workstation:** not supported.
- **HP-UX Operating System:** not supported.

## Before You Begin

The following procedure describes how to connect your plotter to your computer. Before you do this, however, refer to the manual(s) that came with your HP 7510 to:

- Unpack the HP 7510.
- Check the line voltage and fuse.

## HP 7510 Installation Procedure

1. **Play It Safe.**
  - a. Turn your computer and HP 7510 off, if they are not already off.
2. **Select Your Interface.**
  - a. Use either the built-in HP-IB interface or an HP 98624A HP-IB Interface. If using HP-UX, avoid placing the HP 7510 on the same interface used by your disc or tape drives, if possible. A dedicated HP 98624A HP-IB Interface is recommended.

### 3. Connect the Power Cord.

- a. Connect the female end of the power cord to the power socket on the back of the HP 7510, and connect the other end to your power outlet.

### 4. Set the Address.

---

#### CAN YOU SKIP THIS STEP?

If this is the first (or only) recorder or plotter you are connecting to the interface, you can skip to step 5. The address is preset to 5 and need not be changed—*unless* you have changed the address of some other device on the interface to 5.

---

- a. Turn the HP 7510 on.
  - b. Press the **I/O** button to view the I/O menu.
  - c. Press the top menu function button to select the **using HP-IB** function.
  - d. Press the **address is** function button, then press the **7** key to set the address to 7, unless address 7 has been used elsewhere. If it has been used, choose any unused address.
  - e. Press the **ENTER** button to store the address setting.
- ### 5. Connect the HP 7510 to the Computer.
- a. Get an HP-IB cable.
  - b. Connect one end of the HP-IB cable to the HP-IB connector on the back of the HP 7510. Tighten the thumb screws to secure the connection.
  - c. Connect the other end of the HP-IB cable to the interface.

---

#### NOTE

If the interface already has several cables connected to it, connect the plotter's cable to one of the other devices on the interface.

---



## 6. Record the Address.

- a. Make a note that address 5 (or the alternate address you chose in step 4) has been used and is no longer available on the interface you selected. Use the “Address Record” form on the Step 6 tab for this purpose.

---

## The Next Step

You have now installed your HP 7510 Color Film Recorder.

The following “Worksheet Entries” contain information needed to use your HP 7510 with BASIC.

Copy this information to a worksheet (worksheets are found at the end of Step 1) or remember to refer here when you need it.

When finished, you’ll be ready to install your next peripheral.

---

## BASIC System Worksheet Entries

### HP 7510 Connected to Built-in HP-IB Interface (Select Code 7)

Device Name	Device Selector <sup>1</sup>	Display/Plotter Spec.
HP 7510	70 <i>n</i>	“HPGL”

### HP 7510 Connected to HP 98624A HP-IB Interface (Select Code 8)

Device Name	Device Selector <sup>1</sup>	Display/Plotter Spec.
HP 7510	80 <i>n</i>	“HPGL”

---

<sup>1</sup> *n* is a number that identifies the address (set in step 4 of the Installation Procedure). Replace *n* with a 5 if the address was set to 5, use 7 if the address was set to 7, and so on.

---

# Installing the HP 9111A Graphics Tablet

## Description

The HP 9111A Graphics Tablet connects to your computer's HP-IB interface.

## Support

The HP 9111A Graphics Tablet is supported on all Series 200 and Series 300 computers.

Operating/Language system support is as follows:

- **BASIC:** supported on revision 2.0 or later with Series 200 computers; supported on revision 4.0 or later with Series 300 computers.
- **Pascal Workstation:** supported on revision 2.0 or later with Series 200 computers; supported on revision 3.1 or later with Series 300 computers.
- **HP-UX Operating System:** supported on revision 1.0 or later with Series 200 computers; supported on revision 5.0 or later with Series 300 computers.

## Before You Begin

The following procedure describes how to connect your HP 9111A Graphics Tablet to your Series 200/300 computer. Before you do this, however, refer to the manual(s) that came with your graphics table to:

- Unpack the graphics tablet.
- Check the line voltage setting.
- Check the fuse.

## HP 9111A Graphics Tablet Installation Procedure

### 1. Play It Safe.

- a. Turn your computer and graphics tablet off, if they are not already off.

### 2. Select Your Interface.

- a. Use either the built-in HP-IB interface or an HP 98624A HP-IB Interface. If using HP-UX, avoid placing the plotter on the same interface used by your disc or tape drives, if possible. An HP-IB interface dedicated to the HP 9111A is strongly recommended.

### 3. Set the Address.

---

#### CAN YOU SKIP THIS STEP?

If this is the first (or only) HP 9111A you are connecting to the interface, you can skip to step 4. The address is preset to 6 and need not be changed—*unless* you have changed the address of some other device on the interface to 6.

---

- a. Find the set of six switches near the HP-IB connector. The right-hand five switches in this group determine the graphics tablet's address.
- b. Set the address switches to 7 as shown below, unless address 7 has been used elsewhere. Refer to the manual that came with the graphics tablet if you need additional switch settings.

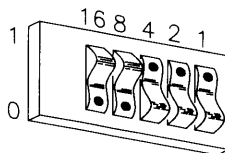

**Address 7**

#### 4. **Connect the HP 9111A to the Computer.**

- a. Get an HP-IB cable.
- b. Connect one end of the HP-IB cable to the HP-IB connector on the back of the graphics tablet. Tighten the thumb screws to secure the connection.
- c. Connect the other end of the HP-IB cable to the interface.

---

#### **NOTE**

If the interface already has several cables connected to it, connect the plotter's cable to one of the other devices on the interface.

---

#### 5. **Connect the Power Cord.**

- a. Connect the female end of the power cord to the power socket on the back of the graphics tablet, and connect the other end to your power outlet.

#### 6. **Record the Address.**

- a. Make a note that address 6 (or the alternate address you chose in step 3) has been used and is no longer available on the interface you selected. Use the "Address Record" form on the Step 6 tab for this purpose.

---

## **The Next Step**

You have now installed your HP 9111A Graphics Tablet.

The following "Worksheet Entries" contain information needed to use your plotter with various language/operating systems. Refer to the entries for the system you'll be using (BASIC, Pascal or HP-UX).

Copy this information to a worksheet (worksheets are found at the end of Step 1) or remember to refer here when you need it.

When finished, you'll be ready to install your next peripheral.

---

## BASIC System Worksheet Entries

HP 9111A Connected to Built-in HP-IB Interface (Select Code 7)

Device Name	Device Selector <sup>1</sup>	Display/Plotter Spec.
HP 9111A	70 <i>n</i>	"HPGL"

HP 9111A Connected to HP 98624A HP-IB Interface (Select Code 8)

Device Name	Device Selector <sup>1</sup>	Display/Plotter Spec.
HP 9111A	80 <i>n</i>	"HPGL"

---

## Pascal Workstation Worksheet Entries

HP 9111A Connected to Built-in HP-IB Interface (Select Code 7)

Device Name	Device Selector <sup>1</sup>
HP 9111A	70 <i>n</i>

HP 9111A Connected to HP 98624A HP-IB Interface (Select Code 8)

Device Name	Device Selector <sup>1</sup>
HP 9111A	80 <i>n</i>

---

<sup>1</sup> *n* is a number that identifies the address (set in step 3 of the Installation Procedure). Replace *n* with a 6 if the address was set to 6, use 7 if the address was set to 7, and so on.

---

## HP-UX System Worksheet Entries

### HP 9111A Connected to Built-in HP-IB Interface (Select Code 7)

Device Name	Path Name	File Type	Major No.	Minor No. <sup>1</sup>
HP 9111A	<i>/dev/dig9111</i>	c	21	0x070n00

### HP 9111A Connected to HP 98624 HP-IB Interface (Select Code 8)

Device Name	Path Name	File Type	Major No.	Minor No. <sup>1</sup>
HP 9111A	<i>/dev/dig9111</i>	c	21	0x080n00

---

<sup>1</sup> *n* is a number that identifies the address (set in step 3 of the Installation Procedure). Replace *n* with a 6 if the address was set to 6, use 7 if the address was set to 7, and so on.

---

# Installing the HP 98700 Graphics Display Station

## Description

The HP 98700 Graphics Display Station connects to the HP 98287A Graphics Display Station Interface. The following procedure describes how to install the HP 98700 Display Controller, the HP 98782A Color Monitor, and the optional HP 98710A Graphics Accelerator upgrade system. Installation of the HP 46081A Speaker Module is described in Step 10.

## Support

The HP 98700 Graphics Display Station is supported on all Series 300 computers.

Operating/Language system support is as follows:

- **BASIC:** supported on revision 4.0 or later with Series 300 computers. The HP 98710A is not supported.
- **Pascal Workstation:** supported on revision 3.1 or later with Series 300 computers. The HP 98710A is not supported.
- **HP-UX Operating System:** supported on revision 5.0 or later with Series 300 computers.

## HP 98700 Graphics Display Station Installation Procedure

1. **Turn your computer off and remove the power cord.**
2. If you have the HP 98710A Graphics Accelerator, follow these steps to connect it:
  - a. **Turn off the HP 98700A and remove the power cord.**
  - b. Remove the cover plate on the front bottom of the HP 98700 and place it in the parking position provided (see Figure 8-1).
  - c. Move the locking mechanism on top of the HP 98710A to the rear.
  - d. Set the HP 98700 on top of the HP 98710A, making sure the guide pins enter the guide pin sockets.
  - e. Gently but firmly press the HP 98700 down until the connector engages and seats (see Figure 8-2).
  - f. Slide the locking mechanism forward to lock the two together.

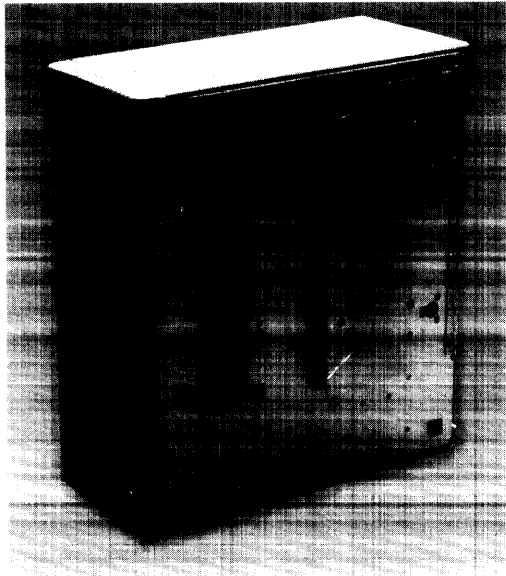

**Figure 8-1. Removing the Cover Plate**



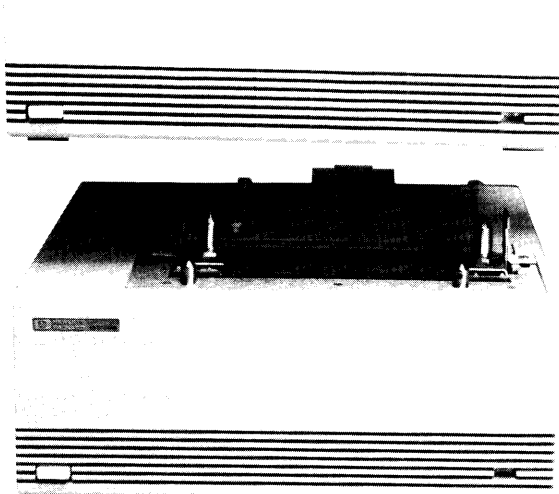

**Figure 8-2. Connecting the HP 98700 to the HP 98710A**

3. Place the HP 98700/98710 between the computer and the monitor.
4. Connect the RGB cables to the monitor, observing the color coding of the cables: red to red, blue to blue and green to green.
5. Connect the other end of the cables to the HP 98700 in the same manner.
6. Connect the interconnect cable to the HP 98287A Graphics Display Station Interface. The cable connector key projects outward near the top from each end of the connector shell. Ensure that this is UP when connecting to the interface or the HP 98700.
7. Connect the other end of the cable to the HP 98700.
8. Make sure all power switches in the system are off, and connect all power cords.

---

## The Next Step

You have now installed your Graphics Display Station.

The following “Worksheet Entries” contain information needed to use your Graphics Display Station with various language/operating systems. Refer to the entries for the system you’ll be using (BASIC, Pascal or HP-UX).

Copy this information to a worksheet (worksheets are found at the end of Step 1) or remember to refer here when you need it.

When finished, you’ll be ready to install your next peripheral.

---

## BASIC System Worksheet Entries

### Graphics Display Station Set to External Addressing Mode

Device Name	Device Selector <sup>1</sup>	Display/Plotter Spec.
HP 98700	25	“INTERNAL”

### Graphics Display Station Set to Internal Addressing Mode

Device Name	Device Selector <sup>2</sup>	Display/Plotter Spec.
HP 98700	1	“INTERNAL”

---

<sup>1</sup> If you changed the select code of the HP 98287A Graphics Display Station Interface, write in the new select code instead of 25. Also, if no internal display is present, you may use a device selector of 1 instead of the select code.

<sup>2</sup> You may alternatively use a device selector of 6 instead of 1.

---

# Pascal Workstation Worksheet Entries

## Graphics Display Station Set to External Addressing Mode

Device Name	Device Selector <sup>1</sup>
HP 98700	25

## Graphics Display Station Set to Internal Addressing Mode

Device Name	Device Selector <sup>2</sup>
HP 98700	3 or 6

---

# HP-UX System Worksheet Entries

## Graphics Display Station Set to External Addressing Mode

Device Name	Path Name	File Type	Major No.	Minor No.
HP 98700, select code 23	<i>/dev/graphics</i>	c	12	0x170200
HP 98700, select code 24	<i>/dev/graphics</i>	c	12	0x180200
HP 98700, select code 25	<i>/dev/graphics</i>	c	12	0x190200
HP 98700, select code 26	<i>/dev/graphics</i>	c	12	0x1a0200
HP 98700, select code 30	<i>/dev/graphics</i>	c	12	0x1e0200

## Graphics Display Station Set to Internal Addressing Mode<sup>3</sup>

Device Name	Path Name	File Type	Major No.	Minor No.
HP 98700, no S300 video	<i>/dev/graphics</i>	c	12	0x000000
HP 98700, with S300 video	<i>/dev/graphics</i>	c	12	0x000100

<sup>1</sup> If you changed the select code of the HP 98287A Graphics Display Station Interface, write in the new select code instead of 25.

<sup>2</sup> For the rules for determining the device selector in this case, refer to the *Graphics Techniques* manual.

<sup>3</sup> Separate entries are provided for systems with an enabled Series 300 built-in video interface ("with S300 video") and for systems without one ("no S300 video"). Choose the entry appropriate for your system.

---

# Installing the HP 13279B Color Monitor

## Description

The HP 13279B Color Monitor connects to the HP 98627A Interface.

---

### IMPORTANT!

This monitor are to be installed by an HP Customer Engineer. Installation and adjustment is included in the price of the monitor.

---

## Support

The HP 13279B Color Monitor is supported on the Series 200 Model 217, 220 and 237 computers, and on all Series 300 computers.

Operating/Language system support is as follows:

- **BASIC:** supported on revision 2.0 or later with Series 200 computers; supported on revision 4.0 or later with Series 300 computers.
- **Pascal Workstation:** supported on revision 2.0 or later with Series 200 computers; supported on revision 3.1 or later with Series 300 computers.
- **HP-UX Operating System:** supported on revision 2.0 or later with Series 200 computers; supported on revision 5.0 or later with Series 300 computers.

## HP 13279B Color Monitor Installation Procedure

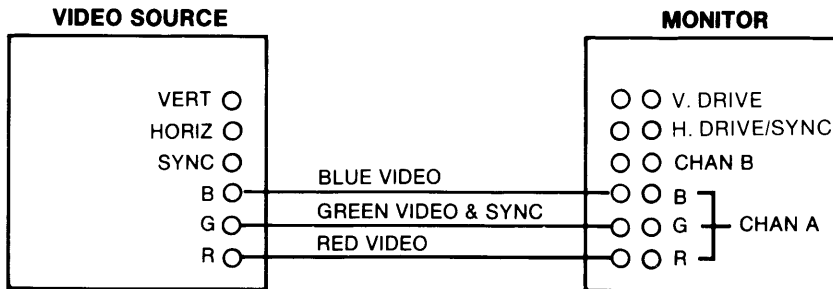

Figure 8-3. HP 13279B Cable Connections.

### 1. Play It Safe.

- a. Contact your HP Sales and Service Office to arrange for installation of your monitor. Installation and adjustment are included in the price of the unit.
- b. Turn your computer off and remove the power cord.

### 2. Connect the Cables.

- a. Connect one cable from the RED video output on the HP 98627A Interface to the CHANNEL A RED IN connector (J1) at the rear of the monitor (see Figure 8-4).
- b. Connect one cable from the GREEN video output on the HP 98627A Interface to the CHANNEL A GREEN IN connector (J3) at the rear of the monitor (see Figure 8-4).
- c. Connect one cable from the BLUE video output on the HP 98627A Interface to the CHANNEL A BLUE IN connector (J5) at the rear of the monitor (see Figure 8-4).

### 3. Connect the Power Cord.

- a. Connect the female end of the power cord to the power socket on the back of the monitor, and connect the other end to your power outlet.

### 4. Adjust the Scan Rate.

- a. Have your HP Customer Engineer adjust the scan rate.

---

## The Next Step

You have now installed your 13279B Color Monitor.

The following “Worksheet Entries” contain information needed to use your monitor with various language/operating systems. Refer to the entries for the system you’ll be using (BASIC, Pascal or HP-UX).

Copy this information to a worksheet (worksheets are found at the end of Step 1) or remember to refer here when you need it.

When finished, you’ll be ready to install your next peripheral.

---

### BASIC System Worksheet Entry

Device Name	Device Selector <sup>1</sup>	Display/Plotter Spec.
HP 13279B	28	“98627A”

---

### Pascal Workstation Worksheet Entry

Device Name	Device Selector <sup>1</sup>
HP 13279B	28

---

### HP-UX System Worksheet Entry

Device Name	Path Name	File Type	Major No.	Minor No. <sup>2</sup>
HP 13279B, select code 28	<i>/dev/graphics</i>	c	12	0x1c0200

<sup>1</sup> If you changed the select code of the HP 98627A Color Output Interface, write in the new select code instead of 28.

<sup>2</sup> If you changed the select code of the HP 98627A Color Output Interface, write in the new select code (in hexadecimal) instead of 1c in the minor number.

---

# Installing the HP 98720A Graphics Display Station

## Description

The HP 98720A Graphics Display Station connects to either the HP 98724A or 98725A Local Graphics Bus Interface, depending on which Series 300 model computer you are using. Model 320 computers require the use of an HP 98724A interface, and Model 330 and 350 computers require an HP 98725A interface. The following procedure describes how to install the HP 98720A Display Controller and the HP 98784A Color Monitor.

---

### CAUTION

Electronic assemblies in the HP 98720A such as the HP 98721A, 98722A, and the 98723A are very susceptible to handling damage. They are installed by HP qualified personnel. Damage caused by users may not be covered under warranty.

---

## Support

The HP 98720A Graphics Display Station is supported on Series 300 Model 320, 330, and 350 computers.

Operating/Language system support is as follows:

- **BASIC:** not supported.
- **Pascal Workstation:** not supported.
- **HP-UX Operating System:** supported on revision 5.18 or later with Series 300 computers.

## Before You Begin

The following procedure describes how to connect your HP 98720A to your Series 300 computer. Before you do this however, refer to the manual(s) that came with the 98720A to:

- Unpack the HP 98720A.
- Check the voltage setting.

## HP 98720A Graphics Display Station Installation Procedure

1. **Play It Safe.**
  - a. Ensure all system power switches are OFF.
  - b. Remove system power cords from the power outlets.
2. Make sure that the correct interface is installed in your computer. Installation of the HP 98724A and 98725A interface cards is covered in Step 5.
  - If you have a **Model 320** computer, you should have an **HP 98724A** Local Graphics Bus (LGB) interface card.
  - If you have a **Model 330 or 350** computer, you need an **HP 98725A** Local Graphics Bus (LGB) interface card.
3. Locate the Graphics Display Station near the computer and the monitor.
4. Connect the RGB cable to the monitor: red to red, green to green, and blue to blue connectors.
5. Connect the other end of the RGB cable to the HP 98720A in the same manner.
6. Connect the LGB cable to the HP 98724A/25A LGB interface connector. The cable connector key projects outward near the top from each end of the connector shell. Ensure that this is UP when connecting it to the interface or the HP 98720A.
7. Connect the other end of the LGB cable to the HP 98720A.
8. After assuring that the power switches are in the OFF position, connect all power cords. If your HP 98720A contains two power supplies, connect both power cords.



---

## The Next Step

You have now installed your HP 98720A Graphics Display Station. Refer to the *Starbase Graphics Techniques HP-UX Concepts and Tutorials* manual (HP part number 98592-90075) for further details. The following “Worksheet Entries” contain information needed to use your HP 98720A with HP-UX.

Copy this information to a worksheet (worksheets are found at the end of Step 1) or remember to refer here when you need it.

When finished, you’ll be ready to install your next peripheral.

---

## HP-UX System Worksheet Entries

### HP 98720A Set to Internal Addressing Mode

Device Name	Path Name	File Type	Major No.	Minor No.
HP 98720A, image planes	<i>/dev/crt</i>	c	12	0x000000
HP 98720A, overlay planes	<i>/dev/ocrt</i>	c	12	0x000001

### HP 98720A Set to External Addressing Mode (Select Code 26-27, 28-29, 30-31)

Device Name	Path Name	File Type	Major Number	Minor Number
HP 98720A, select code 26-27, image planes	<i>/dev/crt</i>	c	12	0x1a0200
HP 98720A, select code 26-27, overlay planes	<i>/dev/ocrt</i>	c	12	0x1a0201
HP 98720A, select code 28-29, image planes	<i>/dev/crt</i>	c	12	0x1c0200
HP 98720A, select code 28-29, overlay planes	<i>/dev/ocrt</i>	c	12	0x1c0201
HP 98720A, select code 30-31, image planes	<i>/dev/crt</i>	c	12	0x1e0200
HP 98720A, select code 30-31, overlay planes	<i>/dev/ocrt</i>	c	12	0x1e0201



# Adding Terminals and Displays

# 9

If you need to install any of the products listed below, turn to the indicated page number and follow the instructions. Otherwise, go to Step 10.

Product Name	Page Number
HP 2392A, 2393A and 2397A Terminals	See page 9-2
HP 2623A, 2624B, 2625A, 2626A, 2627A, 2628A Terminals	See page 9-2
HP 45610A/B HP <i>Touchscreen</i> PC (HP 150)	See page 9-2
HP 45850A/B HP <i>Touchscreen-II</i> PC (HP 150-II)	See page 9-2
HP 45710 HP <i>The Portable</i> PC (HP 110)	See page 9-2
HP 45711 HP <i>The Portable Plus</i> PC (HP 110-Plus)	See page 9-2
HP 9807A <i>Integral</i> PC (HP 9807)	See page 9-2

**Installation of the following terminals and displays are covered in Step 8:**

- HP 13279B Color Monitor
- HP 98700 Graphics Display Station (with HP 98782A Color Monitor)
- HP 98720 Graphics Display Station (with HP 98784A Color Monitor)

---

# Installing HP Terminals

## Description

This section describes the installation of all HP 2390-series and 2620-series terminals, as well as the HP *Touchscreen*, *Portable* and *Integral* PCs when used as a terminal.

HP Terminals connect to any supported Series 200/300 RS-232C interface. The HP 98628A Datacomm or the HP 98642A 4-Channel Multiplexer Interfaces are required for graphics terminals, unless their graphics capability will not be used.

## Support

### Hardware Support

- **HP 2392A Terminal:** supported on all Series 200 computers with boot ROM 3.0 or later except for the Model 216; supported on all Series 300 computers.
- **HP 2393A and HP 2397A Terminals:** supported on Series 200 Model 220 and 237 computers with boot ROM 3.0 or later; supported on all Series 300 computers.
- **HP 2623A Terminal:** supported on all Series 200 computers with boot ROM 3.0 or later except the Model 216.
- **HP 2624B and HP 2626A Terminals:** supported on all Series 200 computers with boot ROM 3.0 or later except the Model 216 and 217.
- **HP 2627A Terminal:** supported on Series 200 Model 226 and 236 computers with boot ROM 3.0 or later.
- **HP Touchscreen, Touchscreen-II, Portable, Portable Plus, and Integral PCs:** supported on all Series 200 computers with boot ROM 3.0 or later except the Model 216; supported on all Series 300 computers.

## Operating/Language System Support

- **BASIC:** not supported.
- **Pascal Workstation:** not supported.
- **HP-UX Operating System:**
  - **HP 2392A Terminal:** supported on revision 2.0 or later with Series 200 computers; supported on revision 5.0 or later with Series 300 computers.
  - **HP 2393A and 2397A Terminals:** supported on revision 2.1 or later with Series 200 computers; supported on revision 5.0 or later with Series 300 computers.
  - **HP 2623A, 2624B, and 2626A Terminals:** supported on revision 2.0 or later with Series 200 computers.
  - **HP 2627A Terminals:** supported on revision 2.1 or later with Series 200 computers.
  - **HP Touchscreen and Touchscreen-II PCs:** supported on revision 2.0 or later with Series 200 computers; supported on revision 5.0 or later with Series 300 computers.
  - **HP Portable, Portable Plus, and Integral PCs:** supported on revision 2.1 or later with Series 200 computers; supported on revision 5.0 or later with Series 300 computers.

## Before You Begin

The following procedure describes how to connect your terminal to your Series 200/300 computer. Before you do this, however, refer to the manual(s) that came with your terminal to:

- Unpack the terminal.
- Connect the keyboard, if applicable.
- Check the voltage.
- Connect the power cable.

## HP Terminal Installation Procedure

### 1. Play It Safe.

- a. Turn your computer and terminal off, if they are not already off.

### 2. Select Your Interface.

- a. Choose any of the following RS-232C Interfaces to connect your terminal:

---

#### NOTE

The HP 98642A or HP 98628A is recommended if you use an application that sends data faster than 2400 baud (average). Such applications include graphics from graphics terminals, softkeys, and reading terminal status.

---

- Built-in RS-232C interface of a Series 300 computer
- Built-in "Data Communications" interface of a Model 216 or Model 217 computer
- HP 98626A RS-232C Interface
- HP 98628A Datacomm Interface
- HP 98642A 4-Channel Multiplexer Interface
- HP 98644A RS-232C Serial Interface

### 3. Select Your Cable(s).

---

#### NOTE

Following are *some* of the possible cabling combinations you can use. Combinations other than those listed may also work.

---

- If you are using the Series 300 built-in RS-232C interface, and are connecting an...
  - **...HP 2392A Terminal**—connect an HP 40242M cable to the terminal's port 1 connector if you have an HP 13232U or Modem~Modem cable leading from the interface; connect an HP 40242C cable to the terminal's port 1 connector if you have an HP 92221P cable leading from the interface.
  - **...HP 2624B or 2626A Terminal, using port 1**—connect an HP 13222N or 92217A cable to the terminal's port 1 connector if you have an HP 13232U or Modem~Modem cable leading from the interface; connect an HP 13222C or 92217C cable to the terminal's port 1 connector if you have an HP 92221P cable leading from the interface.
  - **...HP 2624B or 2626A Terminal, using port 2**—connect an HP 13242N or 92218A cable to the terminal's port 2 connector if you have an HP 13232U or Modem~Modem cable leading from the interface; connect an HP 92221P cable directly between the interface and the terminal's port 2 connector if you have an HP 92221P cable.

- If you are using the Series 200 Model 216 or 217 built-in “Data Communications” interface or an HP 98626A RS-232C Interface, and are connecting an...
  - **...HP 2932A Terminal**—connect an HP 40242M cable to the terminal’s port 1 connector if you have an HP 5061-4216 (Option 2 DCE), 13232U, or Modem~Modem cable leading from the interface.
  - **...HP 2624B or 2626A Terminal, using port 1**—connect an HP 13222N or 92217A cable to the terminal’s port 1 connector.
  - **...HP 2624B or 2626A Terminal, using port 2**—connect an HP 13242N or 92218A cable to the terminal’s port 2 connector if you have an HP 5061-4216 (Option 2 DCE), 13232U, or Modem~Modem cable leading from the interface; connect an HP 13242G or 92219R cable to the terminal’s port 2 connector if you have an HP 5061-4216 (Option 2 DCE) cable leading directly from the interface.
- If you are using an HP 98628A Datacomm Interface, and are connecting an...
  - **...HP 2392A, 2393A or 2397A Terminal**—connect an HP 40242M cable to the terminal’s port 1 connector if you have an HP 5061-4216 (Option 2 DCE), 13232U, or Modem~Modem cable leading from the interface.
  - **...HP Touchscreen, Touchscreen-II, 2624B (using port 2), or 2626A (using port 2)**—connect an HP 13242N or 92218A cable to the terminal if you have an HP 5061-4216 (Option 2 DCE), 13232U, or Modem~Modem cable leading from the interface; connect an HP 13242G or 92219R cable to the terminal if you have an HP 5061-4216 (Option 2 DCE) cable leading directly from the interface.
  - **...HP 2623A, 2624B (using port 1), 2626A (using port 1), or 2627A Terminal**—connect an HP 13222N or 92217A cable to the terminal if you have an HP 5061-4216 (Option 2 DCE), 13232U, or Modem~Modem cable leading from the interface.
  - **...HP Portable or Portable Plus PC**—connect an HP 92221M cable to the *Portable* if you have an HP 5061-4216 (Option 2 DCE), 13232U, or Modem~Modem cable leading from the interface.
  - **...HP Integral PC**—connect an HP 82974A cable to the *Integral* if you have an HP 5061-4216 (Option 2 DCE), 13232U, or Modem~Modem cable leading from the interface.



- If you are using an HP 98642A 4-Channel Multiplexer Interface, port 0, and are connecting an...
  - **...HP 2392A, 2393A or 2397A Terminal**—connect an HP 40242M cable to the terminal's port 1 connector if you have an HP 13232U or Modem~Modem cable leading from port 0 of the interface; connect an HP 40242C cable to the terminal's port 1 connector if you have an HP 13242G or 92219R cable leading from port 0 of the interface; connect an HP 40242G cable directly between port 0 of the interface and port 1 of the terminal.
  - **...HP Touchscreen, Touchscreen-II, 2624B (using port 2), or 2626A (using port 2)**—connect an HP 13242N, 92222M, or 92218A cable to the terminal if you have an HP 13232U or Modem~Modem cable leading from port 0 of the interface; connect an HP 13242G or 92219R cable directly between port 0 of the interface and the terminal.
  - **...HP 2623A, 2624B (using port 1), 2626A (using port 1), or 2627A Terminal**—connect an HP 13222N or 92217A cable to the terminal if you have an HP 13232U, or Modem~Modem cable leading from port 0 of the interface; connect an HP 13222C cable to the terminal if you have an HP 13242G or 92219R cable leading from port 0 of the interface; connect an HP 13222Y or 92217D cable directly between port 0 of the interface and the terminal.
  - **...HP Portable or Portable Plus PC**—connect an HP 92221M cable to the *Portable* if you have an HP 13232U or Modem~Modem cable leading from port 0 of the interface.
  - **...HP Integral PC**—connect an HP 82974A cable to the *Integral* if you have an HP 13232U or Modem~Modem cable leading from port 0 of the interface.

- If using an HP 98642A 4-Channel Multiplexer Interface, port 1, 2 or 3, and you are connecting an...
  - **...HP 2392A, 2393A or 2397A Terminal**—connect an HP 40242C cable between the terminal's port 1 connector and the interface's port 1, 2 or 3 adaptor connector (HP 92219U).
  - **...HP Touchscreen, Touchscreen-II, 2624B (using port 2), or 2626A (using port 2)**—connect the port 1, 2 or 3 adaptor connector (HP 92219U) directly between the interface and the terminal.
  - **...HP 2623A, 2624B (using port 1), 2626A (using port 1), or 2627A Terminal**—connect an HP 13222C cable between the terminal and the interface's port 1, 2 or 3 adaptor connector (HP 92219U).
- If using an HP 98644A RS-232C Serial Interface, and you are connecting an...
  - **...HP 2392A Terminal**—connect an HP 40242M cable to the terminal's port 1 connector if you have an HP 13232U or Modem~Modem cable leading from the interface; connect an HP 40242C cable to the terminal's port 1 connector if you have an HP 92221P cable leading from the interface.
  - **...HP 2624B or 2626A, using port 1**—connect an HP 13222N or 92217A cable to the terminal's port 1 connector if you have an HP 13232U or Modem~Modem cable leading from the interface; connect an HP 13222C or 92217C cable to the terminal's port 1 connector if you have an HP 92221P cable leading from the interface.
  - **...HP 2624B or 2626A, using port 2**—connect an HP 13242N or 92218A cable to the terminal's port 2 connector if you have an HP 13232U or Modem~Modem cable leading from the interface; connect an HP 92221P cable directly between the interface and the terminal's port 2 connector if you have an HP 92221P cable.

#### 4. Connect the Terminal to the Computer.

- a. Connect one end of the terminal's cable to the connector on the back of the terminal. Lock the connector in place using the screws or clips.
- b. If your interface connection requires one or more additional cables, connect the remaining cable(s) to the interface.
- c. Connect the other end of the terminal's cable either directly to the interface or to cable(s) connected to the interface.

**5. Configure the Terminal and Datacomm Port.**

- a. Refer to your terminal's manual for instructions on configuring your terminal and datacomm port to match the characteristics given in Table 9-1. Not all of the characteristics listed in the table will apply to your terminal.

**Table 9-1. Recommended terminal characteristics.**

<b>Characteristic</b>	<b>Setting</b>	<b>Comments</b>
Alternate Set	Line(B)	Suggested
ASCII 8 Bits	No	YES required for NLS support
Asterisk	Off	Suggested
AUTO LF	Off	Required
Auto Terminator	No	Suggested
Baud Rate	9600	HP-UX Std.
Bell	On	Suggested
BLOCK MODE	Off	Required
Block Terminator	RS	Suggested
Break Time	200ms	Suggested
BufSiz	128	Suggested
Caps Lock	Off	May change after login
Carrier Detect	Open	Suggested
Check Parity	No	Required
Circuit Assurance	Closed	Cabling may require
Clear Terminator	No	Suggested
Clock	INT	Required
CPU Break	Open	Suggested
CS(CB)Xmit	No	Cabling may require
Cursor Type	Line	Your choice

**Table 9-1 (Cont.). Recommended terminal characteristics.**

<b>Characteristic</b>	<b>Setting</b>	<b>Comments</b>
Data Bits	8	Required for NLS support
Data Speed Select	Open	Suggested
Datacomm Handshake	XonXoff	Required
DISPLAY FUNCTIONS	Off	Suggested
Display Off After	15 min.	Your choice
DM(CC)Xmit	No	Cabling may require
EnqAck	No	EnqAck not supported
Esc Xfer	Yes	Suggested
Fast Binary Read	Closed	Suggested
Field Separator	US	Suggested
GraphCompat		Your choice
Inh DC2	Yes	Required
InhDcTest	Yes	Suggested
InhEolWrp	No (Closed)	Required
InhHndShk	Yes	Required
InhSkfTst	No	Suggested
Insert & delete sense	Closed	Suggested
Inverse Background		Your choice
Keyboard		Should match your keyboard
LINE MODIFY	Off	Suggested
Line/Page	Line	Required
Local Echo	Off	Suggested
Main Channel	Closed	Should have no effect
MEMORY LOCK	Off	Suggested
MODIFY ALL	Off	Suggested
Parity	None (Open)	Required for NLS support
Power On	Terminal	Suggested

**Table 9-1 (Cont.). Recommended terminal characteristics.**

<b>Characteristic</b>	<b>Setting</b>	<b>Comments</b>
Printer Code 4		Your choice
Printer Nulls		Your choice
RecvPace	XonXoff (Open)	Required
Remote/Serial Dev	PORT1/PORT2	If using terminal's port 1
	PORT2/PORT1	If using terminal's port 2
Remote	On	Required
Resolution	512x390	Required
RETURN Def	CR	Required
RETURN=ENTER	No	Required
RR(CF)Recv	No	Cabling may require
SPOW	No (Closed)	Strongly suggested
SR(CH)	Lo	Modem use may require
SRRInvert	No	Cabling may require
SRRXmit	No	Cabling may require
Start Column	1	Suggested
Stop Bits	1	HP-UX std.
STOP Function	XonXoff	Suggested
StripNulDel	No	Suggested
Tab=Spaces	No	Required
Terminal Id	2622A	Suggested for 2392A
	2623A	Required for DGL on HP150 and 2393A
Terminal Mode	HP	Required by default terminfo
Transmit	All Fields	Suggested
Transmit indicator	Closed	Suggested
TR(CD)	Hi	Modem use may require
XmitFunctn	No (Closed)	vi changes as needed
XmitPace	XonXoff	Suggested

---

## The Next Step

You have now installed your terminal.

The following “Worksheet Entries” contain information needed to use your terminal with HP-UX. Refer to the entry for the interface you connected your terminal to.

Copy this information to a worksheet (worksheets are found at the end of Step 1) or remember to refer here when you need it.

When finished, you’ll be ready to install your next peripheral.

---

## HP-UX System Worksheet Entries

If You Connected the Terminal to a Model 216, Model 217,  
or Series 300 Built-in Interface (Select Code 9)...

Device Name	Path Name <sup>1</sup>	File Type	Major No.	Minor No.
Terminal	<i>/dev/tty02</i>	c	1	0x090004

If You Connected the Terminal to an HP 98626A, 98628A or  
98644A Interface (Select Code 9, 10, 15, 16, 17, 19 or 20)...

Device Name	Path Name <sup>1</sup>	File Type	Major No.	Minor No.
Terminal on select code 9	<i>/dev/tty02</i>	c	1	0x090004
Terminal on select code 10	<i>/dev/tty02</i>	c	1	0x0a0004
Terminal on select code 15	<i>/dev/tty02</i>	c	1	0x0f0004
Terminal on select code 16	<i>/dev/tty02</i>	c	1	0x100004
Terminal on select code 17	<i>/dev/tty02</i>	c	1	0x110004
Terminal on select code 19	<i>/dev/tty02</i>	c	1	0x130004
Terminal on select code 20	<i>/dev/tty02</i>	c	1	0x140004

---

<sup>1</sup> The path name given here assumes this is the second terminal you are connecting (i.e., *tty02*). If this is not the case, change the path name accordingly (e.g., */dev/tty03* for the third terminal, etc.).

---

## HP-UX System Worksheet Entries (Cont.)

If You Connected the Terminal to an HP 98642A Interface (Select Code 10, 13, 15, 16, 17 or 19)...

Device Name	Path <sup>1</sup> Name	File Type	Major Number	Minor Number
Terminal, select code 10, port 0	<i>/dev/tty02</i>	c	1	0x0a0004
Terminal, select code 10, port 1	<i>/dev/tty02</i>	c	1	0x0a0104
Terminal, select code 10, port 2	<i>/dev/tty02</i>	c	1	0x0a0204
Terminal, select code 10, port 3	<i>/dev/tty02</i>	c	1	0x0a0304
Terminal, select code 13, port 0	<i>/dev/tty02</i>	c	1	0x0d0004
Terminal, select code 13, port 1	<i>/dev/tty02</i>	c	1	0x0d0104
Terminal, select code 13, port 2	<i>/dev/tty02</i>	c	1	0x0d0204
Terminal, select code 13, port 3	<i>/dev/tty02</i>	c	1	0x0d0304
Terminal, select code 15, port 0	<i>/dev/tty02</i>	c	1	0x0f0004
Terminal, select code 15, port 1	<i>/dev/tty02</i>	c	1	0x0f0104
Terminal, select code 15, port 2	<i>/dev/tty02</i>	c	1	0x0f0204
Terminal, select code 15, port 3	<i>/dev/tty02</i>	c	1	0x0f0304
Terminal, select code 16, port 0	<i>/dev/tty02</i>	c	1	0x100004
Terminal, select code 16, port 1	<i>/dev/tty02</i>	c	1	0x100104
Terminal, select code 16, port 2	<i>/dev/tty02</i>	c	1	0x100204
Terminal, select code 16, port 3	<i>/dev/tty02</i>	c	1	0x100304
Terminal, select code 17, port 0	<i>/dev/tty02</i>	c	1	0x110004
Terminal, select code 17, port 1	<i>/dev/tty02</i>	c	1	0x110104
Terminal, select code 17, port 2	<i>/dev/tty02</i>	c	1	0x110204
Terminal, select code 17, port 3	<i>/dev/tty02</i>	c	1	0x110304
Terminal, select code 19, port 0	<i>/dev/tty02</i>	c	1	0x130004
Terminal, select code 19, port 1	<i>/dev/tty02</i>	c	1	0x130104
Terminal, select code 19, port 2	<i>/dev/tty02</i>	c	1	0x130204
Terminal, select code 19, port 3	<i>/dev/tty02</i>	c	1	0x130304

<sup>1</sup> The path name given here assumes this is the second terminal you are connecting (i.e., *tty02*). If this is not the case, change the path name accordingly (e.g., */dev/tty03* for the third terminal, etc.).



# Adding Miscellaneous Peripherals **10**

If you need to install any of the products listed below, turn to the indicated page number and follow the instructions. Otherwise, you are done. Begin reading the User's Guide that came with your language system.

<b>Product Number</b>	<b>Page Number</b>
HP 35723A <i>HP Touch Bezel</i>	See page 10-2
HP 37212A 300/1200 Baud Modem	See page 10-9
HP 39800/01A Programmable Bar Code Reader	See page 10-14
HP 45911A Graphics Tablet	See page 10-81
HP 46020/21 Keyboards	See page 10-18
HP 46030A Vectra Keyboard	See page 10-78
HP 46060A/B Mouse	See page 10-22
HP 46080A Extension Module	See page 10-26
HP 46081A Speaker Module	See page 10-30
HP 46082A/B Remote Extension Modules	See page 10-34
HP 46083A Rotary Control Knob	See page 10-39
HP 46084A ID Module	See page 10-43
HP 46085A Control Dials Module	See page 10-47
HP 46086A Button Box	See page 10-51
HP 46087/88A Digitizers & 46089A Cursor	See page 10-55
HP 46094A Quadrature Port	See page 10-59
HP 6944A Multiprogrammer	See page 10-63
HP 92205A/C Hayes <i>Smartmodem 1200</i>	See page 10-66
HP 92916A Bar Code Reader	See page 10-71
HP 98203C Keyboard	See page 10-85
HP 9884A Paper Tape Punch	See page 10-76

---

# Installing the HP 35723A HP Touch Bezel

## Description

The HP 35723A is a user-installable bezel which adds touchscreen capability to the HP 35731 and 35741 12-inch video monitors. It connects to your computer via the HP-HIL interface.

## Support

The HP 35723A is supported on all Series 300 computers.

Operating/Language systems support is as follows:

- **BASIC:** supported on revision 4.0 or later with Series 300 computers.
- **Pascal Workstation:** supported on revision 3.1 or later Series 300 computers, but only as a digitizer in DGL.
- **HP-UX Operating System:** supported on revision 5.0 or later with Series 300 computers.

## HP 35723A HP Touch Bezel Installation Procedure

---

### NOTE

Connecting and disconnecting HP-HIL devices while some language/operating systems or application programs are running may lead to unpredictable results. When possible, connect all needed HP-HIL devices to your computer before booting a language/operating system or running an application program.

---

1. Turn your computer and monitor off.
2. Tilt your monitor screen up as far as it goes. Grasp the inner plastic frame by the lower corners, then pull it up and toward you in one even motion (Figure 10-1).

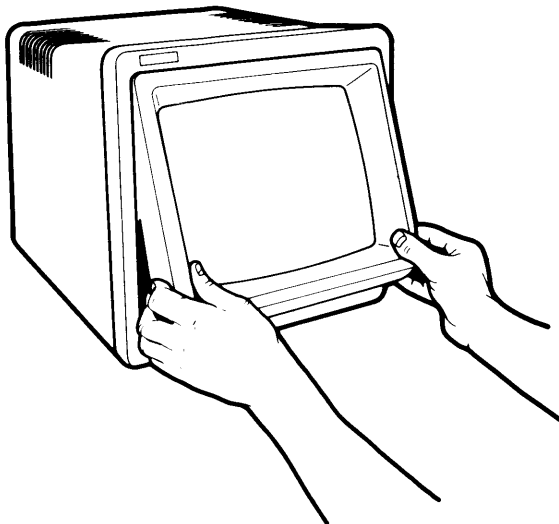

**Figure 10-1. Removing CRT bezel.**

3. Locate the connector socket on your monitor (on the right at the bottom of the display tube). If there is a plug in the socket, remove it (Figure 10-2).

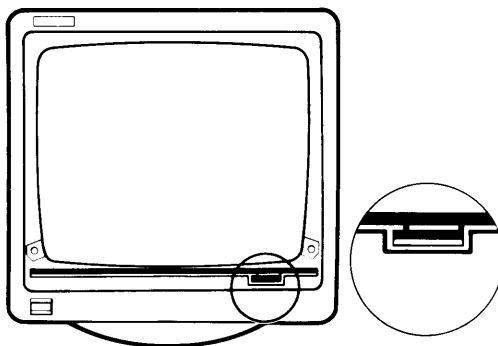

**Figure 10-2. Locating socket on monitor.**

4. Place HP Touch flat on the table in front of the monitor so that the plug on the end of the HP Touch ribbon cable lines up with the socket on your monitor (Figure 10-3).

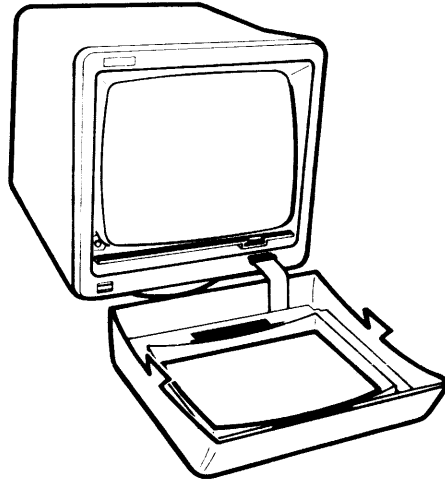

**Figure 10-3. Aligning HP Touch plug with monitor socket.**

5. Connect the HP Touch cable plug to the socket on the monitor. Make sure the cable is not twisted. The plug clicks into the socket when the connection is properly made (Figure 10-4).

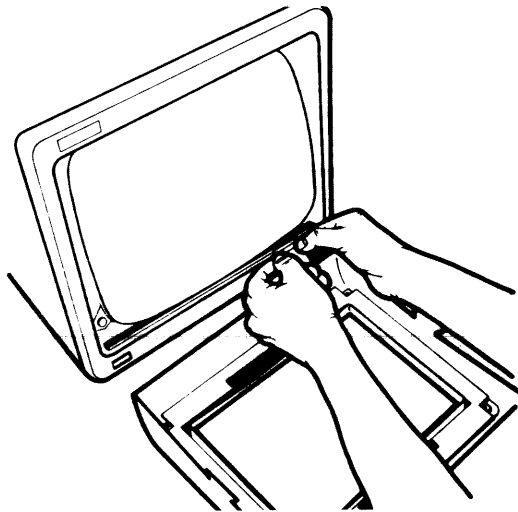

**Figure 10-4. Connecting plug to socket.**

6. Hold HP Touch in front of the monitor. Tilt the top of HP Touch toward the monitor. Line up the upper edge of HP Touch's side mounting tabs so that they slip under the retainer clips on the monitor (Figure 10-5).

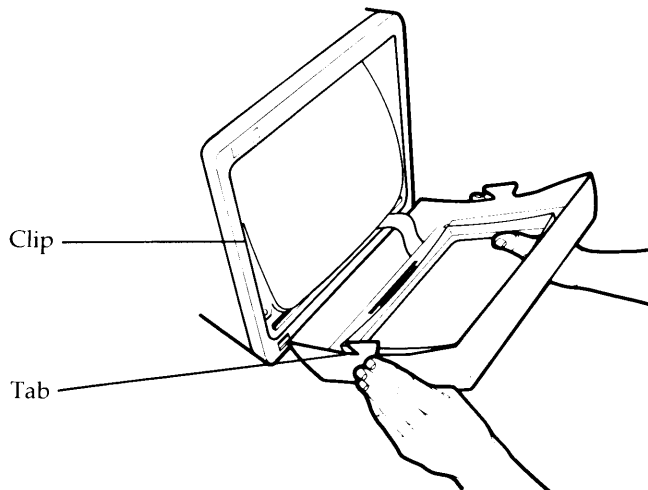

**Figure 10-5. Aligning HP Touch with monitor.**

7. Placing your thumbs under the lower corners of HP Touch, push up and toward the monitor until HP Touch snaps firmly into place. Make sure that the cable does not protrude from HP Touch. If it does protrude, pull out the bottom edge of HP Touch, push the cable under and snap HP Touch back into place (Figure 10-6).

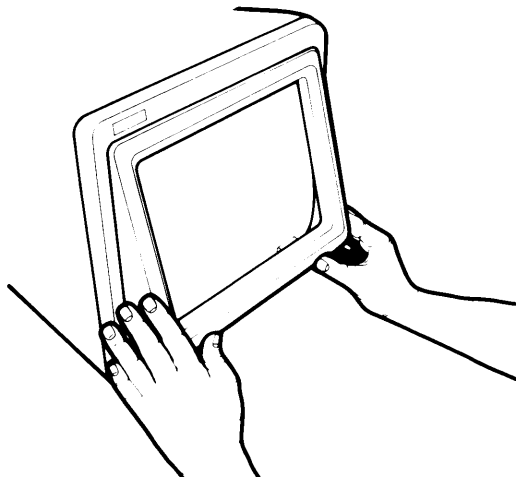

**Figure 10-6. Attaching HP Touch.**

8. Find the HP-HIL cable that you purchased for the monitor. A separate HP-HIL cable is required to connect the monitor to your HP-HIL interface.
  9. Find the end of the cable that is marked with one black dot.
  10. Find the HP-HIL connector on the back of the monitor that is marked with one dot (the inner-most HP-HIL connector).
  11. Plug the “one-dot” end of the cable into the “one-dot” connector on the monitor.
  12. Connect the other, “two-dot” end of the cable into the HP-HIL connector on your computer (marked “KYBD” or “KEYBOARD”), or to the “two-dot” connector of the last HP-HIL device you installed (e.g. keyboard).
  13. Keep these constraints in mind:
    - You cannot have more than 7 HP-HIL addressable devices connected to your computer at one time. The HP 46080A, 46081A, 46082A and 46082B Extension modules and the HP 46089A Four-Button Cursor do not count as addressable devices, and the HP 46085A Control Dials Module counts as *three* addressable devices. All other devices count as one addressable device.
    - The current requirements of all of your devices must not exceed 750 milliamps (mA). To make sure you do not exceed this requirement, total up the typical power required by each of your HP-HIL devices as given in the following “Worksheet Entries” sections. If the total exceeds 750 mA, you must remove one or more devices.
- 

## The Next Step

You have now installed your HP 35723A *HP Touch Bezel*.

The following “Worksheet Entries” contain information needed to use your *HP Touch* bezel with various language/operating systems. Refer to the entries for the system you’ll be using (BASIC, Pascal or HP-UX).

Copy this information to a worksheet (worksheets are found at the end of Step 1) or remember to refer here when you need it.

When finished, you’ll be ready to install your next peripheral. If you have installed all of your peripherals, refer to the *User’s Guide* that came with your operating/language system.

---

## BASIC System Worksheet Entry

---

### CAUTION

New devices added to the HP-HIL interface while the BASIC system is running will not be recognized until a SCRATCH A command is executed. Also, data received from the HP-HIL interface may be garbled if the order of devices is changed while the system is running.

---

Device Name	Device Selector	Digitizer Specifier	Power Req.
HP 35723A	KBD	"TABLET"	133 mA

---

## Pascal Workstation Worksheet Entry

---

### CAUTION

Connecting or disconnecting HP-HIL devices while the Pascal Workstation is running may hang the system. The *only* times when you may safely connect or disconnect an HP-HIL device is when the system's power is off, or while the system's command line is being displayed *and* the time/date display (from the Version command) is not being displayed.

---

Device Name	Device Selector	Module Name	Power Req.
HP 35723A	201	HPHIL & DGL_ABS	133 mA

---

# HP-UX System Worksheet Entries

---

## NOTE

HP-HIL devices can be added to or removed from the HP-HIL interface without affecting the HP-UX operating system. However, if you are running an application which requires the use of a particular device and you remove the device from the link, open the link to the device, or open the link to add a new device, your application might not recognize the change and may not work as expected.

---

Device Name	Path Name	File Type	Major Number	Minor <sup>1</sup> Number	Power Req.
HP 35723A	<i>/dev/r8042</i>	c	23	0x000000	133 mA
HP 35723A	<i>/dev/touch</i>	c	24	0x000020	133 mA

---

<sup>1</sup> The second minor number in the table assumes the digitizer is the second device on the HP-HIL interface (address=2). If this is not the case, substitute the correct position (address) of the digitizer in place of the 2 in the minor number (e.g., if the digitizer is the third device on the interface, the minor number would be 0x000030).



---

# Installing the HP 37212A 300/1200 Baud Modem

## Description

The HP 37212A 300/1200 Baud Modem connects to your computer via an RS-232C interface.

## Support

The HP 37212A 300/1200 Baud Modem is supported on Series 200 Model 217, 220, 226, 236 and 237 computers, and on all Series 300 computers.

Operating/Language system support is as follows:

- **BASIC:** not supported.
- **Pascal Workstation:** supported on revision 3.0 or later with Series 200 computers, but requires user-written software or a terminal emulator software package.
- **HP-UX Operating System:** supported on revision 3.0 or later with Series 200 computers; supported on revision 5.0 or later with Series 300 computers.

## Before You Begin

The following procedure describes how to connect the modem to your computer. Before you do this, however, refer to the manual that came with the modem to:

- Unpack the modem.
- Contact the telephone company.
- Check the voltage setting and fuse.
- Mount the modem in a rack (if applicable).

## **HP 37212A 300/1200 Baud Modem Installation Procedure**

### **1. Play It Safe.**

- a. Turn your computer and modem off, if they are not already off.

### **2. Set the Internal Switches.**

---

#### **CAN YOU SKIP THIS STEP?**

The modem contains eight internal switches which set various operating characteristics of the modem. The switches are all set to the OPEN position and should not be changed, at least not initially. If you later decide that you want to change these switches, refer to the manual that came with the modem for instructions.

---

---

#### **WARNING**

Be sure to disconnect the power cord from the modem whenever you are working with the internal switches and jumpers. Lethal voltages are exposed when the top cover is removed while the power cord is connected.

---

### **3. Connect the Telephone Cable.**

- a. Plug one end of the modular telephone cable into the "TELCO" connector on the back of the modem.
- b. Insert the remaining end of the telephone cable into a telephone wall jack.
- c. If you want to connect a telephone to the modem, plug the telephone's cable into the "PHONE" connector on the back of the modem.

#### **4. Select Your Interface and Cable.**

- a. The modem can be connected to any of the following RS-232C interfaces:
  - Series 200 Model 216 or 217 built-in “Data Communications” interface—use an HP 5061-4215 DTE cable.
  - Series 300 built-in RS-232C interface—use an HP 13242N or 92221M cable.
  - HP 98626A RS-232C Interface—use an HP 5061-4215 (Option 001 DTE) cable.
  - HP 98628A Datacomm Interface—use an HP 5061-4215 (Option 001 DTE) cable.
  - HP 98642A 4-Channel Multiplexer Interface, port 0 (HP-UX only)—use an HP 92219S, 92218A or 92222M cable. Ports 1, 2 and 3 are not recommended for use with the modem.
  - HP 98644A RS-232C Serial Interface—use an HP 13242N, 92218A or 92222M cable.

#### **5. Connect the Modem to Your Computer.**

- a. Connect the cable between the modem and the interface.

#### **6. Connect the Power Cord.**

- a. Connect the power cord into the power connector on the back of the modem, and plug the other end into your power outlet.

#### **7. Set the Front Panel Buttons.**

- a. Turn the modem on.
- b. Locate the set of four buttons labeled HS, ALB, RDL, and DATA on the front of the modem.
- c. Set these buttons as follows:
  - Push the HS button in.
  - Leave the ALB, RDL and DATA buttons out.

---

## The Next Step

You have now installed your modem.

The following “Worksheet Entries” contain information needed to use your modem with various language/operating systems. Refer to the entries for the system you’ll be using (Pascal or HP-UX).

Copy this information to a worksheet (worksheets are found at the end of Step 1) or remember to refer here when you need it.

When finished, you’ll be ready to install your next peripheral. If you have installed all of your peripherals, refer to the *User’s Guide* that came with your operating/language system.

---

## Pascal Workstation Worksheet Entry

Device Name	Device Selector <sup>1</sup>
HP 37212A	9

---

## HP-UX System Worksheet Entries

If You Connected the Modem to a Model 216, Model 217,  
or Series 300 Built-in Interface (Select Code 9)...

Device Name	Path Name <sup>2</sup>	File Type	Major No.	Minor No.
HP 37212A	<i>/dev/tty02</i>	c	1	0x090000
HP 37212A	<i>/dev/cua02</i>	c	1	0x090001
HP 37212A	<i>/dev/cul02</i>	c	1	0x090001

---

<sup>1</sup> If you connected your modem to an interface with a select code other than 9, write in your select code instead of 9.

<sup>2</sup> The path names given here assume this is the second terminal or modem you are connecting (i.e., *tty02*). If this is not the case, change the path names accordingly (e.g., */dev/tty03* for the third modem, etc.).

---

## HP-UX System Worksheet Entries (Cont.)

If You Connected the Modem to an HP 98626A, 98628A, 98642A or 98644A Interface (Select Code 9, 10, 13, 15, 16, 17, 19 or 20)...

Device Name	Path Name <sup>1</sup>	File Type	Major No.	Minor No.
HP 37212A on select code 9	<i>/dev/tty02</i>	c	1	0x090000
HP 37212A on select code 9	<i>/dev/cua02</i>	c	1	0x090001
HP 37212A on select code 9	<i>/dev/cul02</i>	c	1	0x090001
HP 37212A on select code 10	<i>/dev/tty02</i>	c	1	0x0a0000
HP 37212A on select code 10	<i>/dev/cua02</i>	c	1	0x0a0001
HP 37212A on select code 10	<i>/dev/cul02</i>	c	1	0x0a0001
HP 37212A on select code 13	<i>/dev/tty02</i>	c	1	0x0d0000
HP 37212A on select code 13	<i>/dev/cua02</i>	c	1	0x0d0001
HP 37212A on select code 13	<i>/dev/cul02</i>	c	1	0x0d0001
HP 37212A on select code 15	<i>/dev/tty02</i>	c	1	0x0f0000
HP 37212A on select code 15	<i>/dev/cua02</i>	c	1	0x0f0001
HP 37212A on select code 15	<i>/dev/cul02</i>	c	1	0x0f0001
HP 37212A on select code 16	<i>/dev/tty02</i>	c	1	0x100000
HP 37212A on select code 16	<i>/dev/cua02</i>	c	1	0x100001
HP 37212A on select code 16	<i>/dev/cul02</i>	c	1	0x100001
HP 37212A on select code 17	<i>/dev/tty02</i>	c	1	0x110000
HP 37212A on select code 17	<i>/dev/cua02</i>	c	1	0x110001
HP 37212A on select code 17	<i>/dev/cul02</i>	c	1	0x110001
HP 37212A on select code 19	<i>/dev/tty02</i>	c	1	0x130000
HP 37212A on select code 19	<i>/dev/cua02</i>	c	1	0x130001
HP 37212A on select code 19	<i>/dev/cul02</i>	c	1	0x130001
HP 37212A on select code 20	<i>/dev/tty02</i>	c	1	0x140000
HP 37212A on select code 20	<i>/dev/cua02</i>	c	1	0x140001
HP 37212A on select code 20	<i>/dev/cul02</i>	c	1	0x140001

<sup>1</sup> The path names given here assume this is the second terminal or modem you are connecting (i.e., *tty02*). If this is not the case, change the path names accordingly (e.g., */dev/tty03* for the third modem, etc.).

---

# Installing the HP 39800/01A Programmable Bar Code Reader

## Description

The HP 39800/01A programmable bar code reader connects to your computer through an HP 98626A or HP 98628A interface.

## Support

The HP 39800/01A programmable bar code reader is supported on all Series 200 computers.

Language/Operating system support is as follows:

- **BASIC:** supported on revision 2.0 and later with Series 200 computers.
- **Pascal Workstation:** not supported.
- **HP-UX Operating System:** not supported.

# Programmable Bar Code Reader Installation Procedure

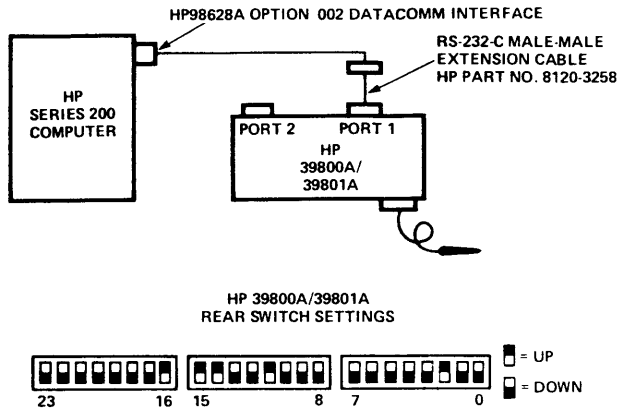

Figure 10-7a.

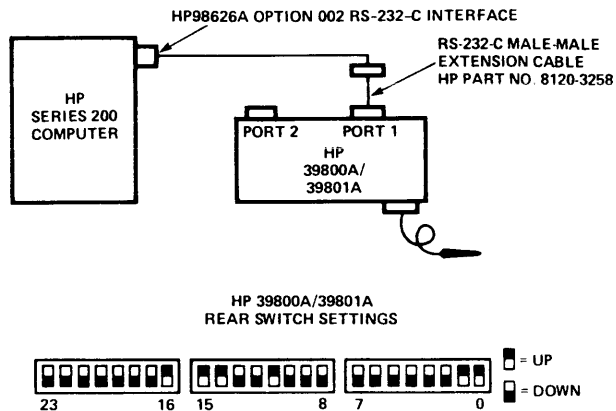

Figure 10-7b.

### 1. **Play It Safe.**

- a. Turn your computer off, if it is not already off.

### 2. **Set the Configuration Switches.**

- a. Find the Configuration switches on the back of the bar code reader.
- b. Set the switches:
  - Set the switches as shown in Figure 10-7a if connecting the bar code reader to an HP 98628A Datacomm Interface.
  - Set the switches as shown in Figure 10-7b if connecting the bar code reader to an HP 98626A RS-232C Interface.

### 3. **Connect the Bar Code Reader to Your Computer.**

- a. Connect the RS-232C cables from the computer to Port 1 of the bar code reader as shown in Figures 10-7a and 10-7b.

### 4. **Connect the Power Cord.**

- a. Connect the female end of the power cord to the power socket on the back of the bar code reader, and plug the other end into your power outlet.

---

## The Next Step

You have now installed your bar code reader.

The following “Worksheet Entries” contain information needed to use your bar code reader with BASIC.

Copy this information to a worksheet (worksheets are found at the end of Step 1) or remember to refer here when you need it.

When finished, you’ll be ready to install your next peripheral. If you have installed all of your peripherals, refer to the *User’s Guide* that came with your operating/language system.



---

# BASIC System Worksheet Entries

**If You Connected the Bar Code Reader to the  
HP 98626A RS-232C Interface...**

Device Name	Device Selector <sup>1</sup>
HP 39800/01A	9

**If You Connected the Bar Code Reader to the  
HP 98628A Datacomm Interface...**

Device Name	Device Selector <sup>2</sup>
HP 39800/01A	20

---

<sup>1</sup> If you changed the select code of the HP 98626A RS-232C Interface, write in the new select code instead of 9.

<sup>2</sup> If you change the select code of the HP 98628A Datacomm Interface, write in the new select code instead of 20.

---

# Installing the HP 46020/21 Keyboards

## Description

The HP 46020/21 Keyboards are offered in 17 languages and connect to your computer via the HP-HIL interface.

## Support

The HP 46020/21 Keyboards are supported on Series 200 Model 217, 220 (with the optional HP-HIL interface installed) and Model 237 computers, and on all Series 300 computers.

Operating/Language systems support is as follows:

- **BASIC:** supported on revision 3.0 or later with Series 200 computers; supported on revision 4.0 or later with Series 300 computers.
- **Pascal Workstation:** supported on revision 3.0 or later with Series 200 computers; supported on revision 3.1 or later with Series 300 computers.
- **HP-UX Operating System:** supported on revision 2.2L or later with Series 200 computers; supported on revision 5.0 or later with Series 300 computers.

## HP 46020/21 Keyboard Installation Procedure

---

### NOTE

Connecting and disconnecting HP-HIL devices while some language/operating systems or application programs are running may lead to unpredictable results. When possible, connect all needed HP-HIL devices to your computer before booting a language/operating system or running an application program.

---

1. Find the HP-HIL cable that came with your computer.
2. Find the end of the cable that is marked with one black dot.
3. Find the connector on the back of the keyboard that is marked with one dot.

4. Plug the “one-dot” end of the cable into the “one-dot” connector on the keyboard.
  5. Connect the other, “two-dot” end of the cable into the HP-HIL connector on your computer (marked “KYBD” or “KEYBOARD”), or to the “two-dot” connector of the last HP-HIL device you installed.
  6. Keep these constraints in mind:
    - You cannot have more than 7 HP-HIL addressable devices connected to your computer at one time. The HP 46080A, 46081A, 46082A and 46082B Extension modules and the HP 46089A Four-Button Cursor do not count as addressable devices, and the HP 46085A Control Dials Module counts as *three* addressable devices. All other devices count as one addressable device.
    - The current requirements of all of your devices must not exceed 750 milliamps (mA). To make sure you do not exceed this requirement, total up the typical power required by each of your HP-HIL devices as given in the following “Worksheet Entries” sections. If the total exceeds 750 mA, you must remove one or more devices.
- 

## The Next Step

You have now installed your HP 46020/21 Keyboard.

The following “Worksheet Entries” contain information needed to use your keyboard with various language/operating systems. Refer to the entries for the system you’ll be using (BASIC, Pascal or HP-UX).

Copy this information to a worksheet (worksheets are found at the end of Step 1) or remember to refer here when you need it.

When finished, you’ll be ready to install your next peripheral. If you have installed all of your peripherals, refer to the *User’s Guide* that came with your operating/language system.

---

## BASIC System Worksheet Entry

---

### CAUTION

New devices added to the HP-HIL interface while the BASIC system is running will not be recognized until a SCRATCH A command is executed. Also, data received from the HP-HIL interface may be garbled if the order of devices is changed while the system is running.

---

Device Name	Device Selector	Digitizer Specifier	Power Req.
HP 46020/21A	KBD	"KBD"	67 mA

---

## Pascal Workstation Worksheet Entry

---

### CAUTION

Connecting or disconnecting HP-HIL devices while the Pascal Workstation is running may hang the system. The *only* times when you may safely connect or disconnect an HP-HIL device is when the system's power is off, or while the system's command line is being displayed *and* the time/date display (from the Version command) is not being displayed.

---

Device Name	Device Selector	Module Name	Power Req.
HP 46020/21A	2	—	67 mA

---

## HP-UX System Worksheet Entries

---

### NOTE

HP-HIL devices can be added to or removed from the HP-HIL interface without affecting the HP-UX operating system. However, if your application requires the use of a particular device and you remove the device from the link, open the link to the device, or open the link to add a new device, your application might not recognize the change and may not work as expected.

---

Device Name	Path Name	File Type	Major Number	Minor <sup>1</sup> Number	Power Req.
HP 46020/21	<i>/dev/r8042</i>	c	23	0x000000	67 mA
HP 46020/21	<i>/dev/rkbd</i>	c	24	0x000010	67 mA

---

<sup>1</sup> The second minor number in the table assumes the keyboard is the first device on the HP-HIL interface (address=1). If this is not the case, substitute the correct position (address) of the keyboard in place of the 1 in the minor number (e.g., if the keyboard is the third device on the interface, the minor number would be 0x000030).

---

# Installing the HP 46060A/B Mouse

## Description

The HP 46060A is a two-button mouse; the HP 46060B is a three-button mouse. Both connect to your computer via the HP-HIL interface and must be the last device in the chain of HP-HIL devices connected to the interface.

## Support

The HP 46060A is supported on Series 200 Model 217, 220 (with the optional HP-HIL interface installed) and Model 237 computers, and on all Series 300 computers. The HP 46060B is supported on all Series 300 computers. Support of the HP 46060B for Series 200 Model 220 and 237 computers was under investigation at time of printing.

Operating/Language systems support is as follows:

- **BASIC:** The HP 46060A is supported on revision 3.0 or later with Series 200 computers; supported on revision 4.0 or later with Series 300 computers. The HP 46060B is supported on revision 3.0 or later with Series 200 computers; supported on revision 4.0 or later with Series 300 computers.
- **Pascal Workstation:** The HP 46060A is supported on revision 3.0 or later with Series 200 computers; supported on revision 3.1 or later with Series 300 computers. The HP 46060B is supported on revision 3.1 or later with Series 200 computers; supported on revision 3.2 or later with Series 300 computers.
- **HP-UX Operating System:** The HP 46060A is supported on revision 5.1 or later with Series 200 computers; supported on revision 5.0 or later with Series 300 computers. The HP 46060B is supported on revision 5.2 or later with Series 300 computers only.

## HP 46060A/B Mouse Installation Procedure

---

### NOTE

Connecting and disconnecting HP-HIL devices while some language/operating systems or application programs are running may lead to unpredictable results. When possible, connect all needed HP-HIL devices to your computer before booting a language/operating system or running an application program.

---

1. Install all other HP-HIL devices first. The HP 46060A/B Mouse must be the last device you connect to the interface.
2. Turn the mouse upside down and locate the ball housing cover. Remove the ball housing cover by turning it counterclockwise.
3. Insert the ball into its housing. Replace the cover and secure it by turning it clockwise.
4. Connect the end of the mouse cable into the “two-dot” HP-HIL connector of the last HP-HIL device you installed. If you’ve just installed your computer, the last HP-HIL device you installed is your keyboard.
5. Keep these constraints in mind:
  - You cannot have more than 7 HP-HIL addressable devices connected to your computer at one time. The HP 46080A, 46081A, 46082A and 46082B Extension modules and the HP 46089A Four-Button Cursor do not count as addressable devices, and the HP 46085A Control Dials Module counts as *three* addressable devices. All other devices count as one addressable device.
  - The current requirements of all of your devices must not exceed 750 milliamps (mA). To make sure you do not exceed this requirement, total up the typical power required by each of your HP-HIL devices as given in the following “Worksheet Entries” sections. If the total exceeds 750 mA, you must remove one or more devices.

---

## The Next Step

You have now installed your HP 46060A/B Mouse.

The following “Worksheet Entries” contain information needed to use your mouse with various language/operating systems. Refer to the entries for the system you’ll be using (BASIC, Pascal or HP-UX).

Copy this information to a worksheet (worksheets are found at the end of Step 1) or remember to refer here when you need it.

When finished, you’ll be ready to install your next peripheral. If you have installed all of your peripherals, refer to the *User’s Guide* that came with your operating/language system.

---

## BASIC System Worksheet Entry

---

### CAUTION

New devices added to the HP-HIL interface while the BASIC system is running will not be recognized until a SCRATCH A command is executed. Also, data received from the HP-HIL interface may be garbled if the order of devices is changed while the system is running.

---

Device Name	Device Selector	Digitizer Specifier	Power Req.
HP 46060A/B	KBD	“KBD”	133 mA



---

## Pascal Workstation Worksheet Entry

---

### CAUTION

Connecting or disconnecting HP-HIL devices while the Pascal Workstation is running may hang the system. The *only* times when you may safely connect or disconnect an HP-HIL device is when the system's power is off, or while the system's command line is being displayed *and* the time/date display (from the Version command) is not being displayed.

---

Device Name	Device Selector	Module Name	Power Req.
HP 46060A/B	2	HPHIL & MOUSE	133 mA

---

## HP-UX System Worksheet Entries

---

### NOTE

HP-HIL devices can be added to or removed from the HP-HIL interface without affecting the HP-UX operating system. However, if your application requires the use of a particular device and you remove the device from the link, open the link to the device, or open the link to add a new device, your application might not recognize the change and may not work as expected.

---

Device Name	Path Name	File Type	Major No.	Minor No. <sup>1</sup>	Power Req.
HP 46060A/B	/dev/r8042	c	23	0x000000	133 mA
HP 46060A/B	/dev/mouse	c	24	0x000020	133 mA

---

<sup>1</sup> The second minor number in the table assumes the mouse is the second device on the HP-HIL interface (address=2). If this is not the case, substitute the correct position (address) of the mouse in place of the 2 in the minor number (e.g., if the mouse is the third device on the interface, the minor number would be 0x000030).

---

# Installing the HP 46080A Extension Module

## Description

The HP 46080A is used to extend the distance between HP-HIL devices. It connects to your computer via the HP-HIL interface, and occupies no HP-HIL address.

## Support

The HP 46080A is supported on Series 200 Model 217, 220 (with the optional HP-HIL interface installed) and Model 237 computers, and on all Series 300 computers.

Operating/Language systems support is as follows:

- **BASIC:** supported on revision 3.0 or later with Series 200 computers; supported on revision 4.0 or later with Series 300 computers.
- **Pascal Workstation:** supported on revision 3.0 or later with Series 200 computers; supported on revision 3.1 or later with Series 300 computers.
- **HP-UX Operating System:** supported on revision 2.1 or later with Series 200 computers; supported on revision 5.0 or later with Series 300 computers.

## HP 46080A Extension Module Installation Procedure

---

### NOTE

Connecting and disconnecting HP-HIL devices while some language/operating systems or application programs are running may lead to unpredictable results. When possible, connect all needed HP-HIL devices to your computer before booting a language/operating system or running an application program.

---

1. Select a suitable mounting location for the connector box. Remove the paper backing from the back of the fastener pad. Place the pad at the location and press down firmly for a few seconds. Attach the connector box to the fastener pad.
2. Turn the computer off.

3. Find the end of the HP-HIL cable that is marked with one black dot.
  4. Find the HP-HIL connector on the connector box that is marked with one dot.
  5. Plug the “one-dot” end of the cable into the “one-dot” connector on the connector box.
  6. Connect the other, “two-dot” end of the cable into the HP-HIL connector on your computer (marked “KYBD” or “KEYBOARD”), or to the “two-dot” connector of the last HP-HIL device you installed (e.g. keyboard).
  7. Keep these constraints in mind:
    - You cannot have more than 7 HP-HIL addressable devices connected to your computer at one time. The HP 46080A, 46081A, 46082A and 46082B Extension modules and the HP 46089A Four-Button Cursor do not count as addressable devices, and the HP 46085A Control Dials Module counts as *three* addressable devices. All other devices count as one addressable device.
    - The current requirements of all of your devices must not exceed 750 milliamps (mA). To make sure you do not exceed this requirement, total up the typical power required by each of your HP-HIL devices as given in the following “Worksheet Entries” sections. If the total exceeds 750 mA, you must remove one or more devices.
- 

## The Next Step

You have now installed your HP 46080A Extension Module.

The following “Worksheet Entries” contain information needed to use your HP 46080A with various language/operating systems. Refer to the entries for the system you’ll be using (BASIC, Pascal or HP-UX).

Copy this information to a worksheet (worksheets are found at the end of Step 1) or remember to refer here when you need it.

When finished, you’ll be ready to install your next peripheral. If you have installed all of your peripherals, refer to the *User’s Guide* that came with your operating/language system.

---

## BASIC System Worksheet Entry

---

### CAUTION

New devices added to the HP-HIL interface while the BASIC system is running will not be recognized until a SCRATCH A command is executed. Also, data received from the HP-HIL interface may be garbled if the order of devices is changed while the system is running.

---

Device Name	Device Selector	Digitizer Specifier	Power Req.
HP 46080A	—	—	17 mA

---

## Pascal Workstation Worksheet Entry

---

### CAUTION

Connecting or disconnecting HP-HIL devices while the Pascal Workstation is running may hang the system. The *only* times when you may safely connect or disconnect an HP-HIL device is when the system's power is off, or while the system's command line is being displayed *and* the time/date display (from the Version command) is not being displayed.

---

Device Name	Device Selector	Module Name	Power Req.
HP 46080A	—	—	17 mA

---

## HP-UX System Worksheet Entries

---

### NOTE

HP-HIL devices can be added to or removed from the HP-HIL interface without affecting the HP-UX operating system. However, if your application requires the use of a particular device and you remove the device from the link, open the link to the device, or open the link to add a new device, your application might not recognize the change and may not work as expected.

---

Device Name	Path Name	File Type	Major Number	Minor Number	Power Req.
HP 46080A	—	—	—	—	17 mA

---

# Installing the HP 46081A Speaker Module

## Description

The HP 46081A Speaker Module is used to extend the distance between HP-HIL devices and includes an audio speaker on a separate circuit, with a 3m audio cable. It connects to your computer via the HP-HIL interface, and occupies no HP-HIL address.

## Support

The HP 46081A is supported on Series 200 Model 217, 220 (with the optional HP-HIL interface installed) and Model 237 computers, and on all Series 300 computers.

Operating/Language systems support is as follows:

- **BASIC:** supported on revision 3.0 or later with Series 200 computers; supported on revision 4.0 or later with Series 300 computers.
- **Pascal Workstation:** supported on revision 3.0 or later with Series 200 computers; supported on revision 3.1 or later with Series 300 computers.
- **HP-UX Operating System:** supported on revision 2.1 or later with Series 200 computers; supported on revision 5.0 or later with Series 300 computers.

## HP 46081A Speaker Module Installation Procedure

---

### NOTE

Connecting and disconnecting HP-HIL devices while some language/ operating systems or application programs are running may lead to unpredictable results. When possible, connect all needed HP-HIL devices to your computer before booting a language/operating system or running an application program.

---

1. Select a suitable mounting location for the Speaker Module. Remove the paper backing from the back of the fastener pad. Place the pad at the location and press down firmly for a few seconds. Attach the Speaker Module to the fastener pad.

2. Turn the computer off and check whether there is an existing HP-HIL cable connected to the “KYBD” (or “KEYBOARD”) connector on the back of the computer. If so, disconnect it.
3. Find the end of the HP-HIL cable that is marked with one black dot.
4. Find the connector on the back of the Speaker Module that is marked with one dot.
5. Plug the “one-dot” end of the cable into the “one-dot” connector on the Speaker Module.
6. Connect the other, “two-dot” end of the cable into the HP-HIL connector on your computer (marked “KYBD” or “KEYBOARD”).
7. Plug either end of the furnished audio cable into the audio jack on the Speaker Module. Plug the other end of the audio cable into the audio jack near the HP-HIL connector on your computer.
8. If you disconnected an HP-HIL device from the computer in step 2, reconnect it to the “two-dot” jack on the speaker module.
9. Keep these constraints in mind:
  - You cannot have more than 7 HP-HIL addressable devices connected to your computer at one time. The HP 46080A, 46081A, 46082A and 46082B Extension modules and the HP 46089A Four-Button Cursor do not count as addressable devices, and the HP 46085A Control Dials Module counts as *three* addressable devices. All other devices count as one addressable device.
  - The current requirements of all of your devices must not exceed 750 milliamps (mA). To make sure you do not exceed this requirement, total up the typical power required by each of your HP-HIL devices as given in the following “Worksheet Entries” sections. If the total exceeds 750 mA, you must remove one or more devices.

---

## The Next Step

You have now installed your HP 46081A Speaker Module.

The following “Worksheet Entries” contain information needed to use your HP 46081A with various language/operating systems. Refer to the entries for the system you’ll be using (BASIC, Pascal or HP-UX).

Copy this information to a worksheet (worksheets are found at the end of Step 1) or remember to refer here when you need it.

When finished, you’ll be ready to install your next peripheral. If you have installed all of your peripherals, refer to the *User’s Guide* that came with your operating/language system.

---

## BASIC System Worksheet Entry

---

### CAUTION

New devices added to the HP-HIL interface while the BASIC system is running will not be recognized until a SCRATCH A command is executed. Also, data received from the HP-HIL interface may be garbled if the order of devices is changed while the system is running.

---

Device Name	Device Selector	Digitizer Specifier	Power Req.
HP 46081A	—	—	17 mA



---

## Pascal Workstation Worksheet Entry

---

### CAUTION

Connecting or disconnecting HP-HIL devices while the Pascal Workstation is running may hang the system. The *only* times when you may safely connect or disconnect an HP-HIL device is when the system's power is off, or while the system's command line is being displayed *and* the time/date display (from the Version command) is not being displayed.

---

Device Name	Device Selector	Module Name	Power Req.
HP 46081A	—	—	17 mA

---

## HP-UX System Worksheet Entries

---

### NOTE

HP-HIL devices can be added to or removed from the HP-HIL interface without affecting the HP-UX operating system. However, if your application requires the use of a particular device and you remove the device from the link, open the link to the device, or open the link to add a new device, your application might not recognize the change and may not work as expected.

---

Device Name	Path Name	File Type	Major Number	Minor Number	Power Req.
HP 46081A	—	—	—	—	17 mA

---

# Installing the HP 46082A/B Remote Extension Modules

## Description

The HP 46082A/B are used to extend the distance between HP-HIL devices and between monitors and their video interfaces. Both connect to your computer via the HP-HIL interface, and occupy no HP-HIL addresses.

## Support

The HP 46082A/B are supported on Series 200 Model 217, 220 (with the optional HP-HIL interface installed) and Model 237 computers, and on all Series 300 computers.

Operating/Language systems support is as follows:

- **BASIC:** supported on revision 3.0 or later with Series 200 computers; supported on revision 4.0 or later with Series 300 computers.
- **Pascal Workstation:** supported on revision 3.0 or later with Series 200 computers; supported on revision 3.1 or later with Series 300 computers.
- **HP-UX Operating System:** supported on revision 2.1 or later with Series 200 computers; supported on revision 5.0 or later with Series 300 computers.

# HP 46082A/B Remote Extension Module Installation Procedure

---

## NOTE

Connecting and disconnecting HP-HIL devices while some language/operating systems or application programs are running may lead to unpredictable results. When possible, connect all needed HP-HIL devices to your computer before booting a language/operating system or running an application program.

---

### 1. Install the Control Boxes.

- a. Select mounting locations for the control boxes. The control box near the computer must be within 500mm (1.64 feet) of the back of the computer.
- b. Remove the paper covering from the back of the fastener pads.
- c. Place the fastener pads at the selected locations and press down firmly for a few seconds.
- d. Slide the control boxes onto the fastener pads from the side.
- e. Twist the control boxes a few degrees to lock them onto the fastener pads.

### 2. Connect the Extension Module.

- a. Turn the computer off and check whether there is an existing HP-HIL cable connected to the “KYBD” (or “KEYBOARD”) connector on the back of the computer. If so, disconnect it.
- b. Get the short HP-HIL cable. Find the end of this cable that is marked with one black dot.
- c. Look at the control module nearest the computer. Find the connector on the back of this control module that is marked with one dot.
- d. Plug the “one-dot” end of the short HP-HIL cable into the “one-dot” connector on the nearest control module.
- e. Connect the other, “two-dot” end of the short HP-HIL cable into the HP-HIL connector on your computer (marked “KYBD” or “KEYBOARD”).

- f. Plug either end of the furnished audio cable into the audio jack on the same control module. Plug the other end of the audio cable into the audio jack near the HP-HIL connector on your computer.
- g. Plug either end of the extension cable into the control box nearest the computer.
- h. Plug the other end of the extension cable into the other (distant) control box.
- i. If you disconnected an HP-HIL device from the computer in step 2-a, reconnect it to the “two-dot” jack on the distant control box.
- j. Plug one end of each video cable into the corresponding video connector in the computer. The ends are interchangeable. Refer to the red, green and blue labels attached to the cables.
- k. Plug the other end of each video cable into the video input connectors on the monitor. Again refer to the color-coded labels attached to the cables.

### 3. **Keep These Constraints In Mind:**

- You cannot have more than 7 HP-HIL addressable devices connected to your computer at one time. The HP 46080A, 46081A, 46082A and 46082B Extension modules and the HP 46089A Four-Button Cursor do not count as addressable devices, and the HP 46085A Control Dials Module counts as *three* addressable devices. All other devices count as one addressable device.
- The current requirements of all of your devices must not exceed 750 milliamps (mA). To make sure you do not exceed this requirement, total up the typical power required by each of your HP-HIL devices as given in the following “Worksheet Entries” sections. If the total exceeds 750 mA, you must remove one or more devices.

---

## The Next Step

You have now installed your HP 46082A/B Remote Extension Module.

The following “Worksheet Entries” contain information needed to use your HP 46082A/B with various language/operating systems. Refer to the entries for the system you’ll be using (BASIC, Pascal or HP-UX).

Copy this information to a worksheet (worksheets are found at the end of Step 1) or remember to refer here when you need it.

When finished, you’ll be ready to install your next peripheral. If you have installed all of your peripherals, refer to the *User’s Guide* that came with your operating/language system.

---

## BASIC System Worksheet Entry

---

### CAUTION

New devices added to the HP-HIL interface while the BASIC system is running will not be recognized until a SCRATCH A command is executed. Also, data received from the HP-HIL interface may be garbled if the order of devices is changed while the system is running.

---

Device Name	Device Selector	Digitizer Specifier	Power Req.
HP 46082A/B	—	—	33 mA

---

## Pascal Workstation Worksheet Entry

---

### CAUTION

Connecting or disconnecting HP-HIL devices while the Pascal Workstation is running may hang the system. The *only* times when you may safely connect or disconnect an HP-HIL device is when the system's power is off, or while the system's command line is being displayed *and* the time/date display (from the Version command) is not being displayed.

---

Device Name	Device Selector	Module Name	Power Req.
HP 46082A/B	—	—	33 mA

---

## HP-UX System Worksheet Entries

---

### NOTE

HP-HIL devices can be added to or removed from the HP-HIL interface without affecting the HP-UX operating system. However, if your application requires the use of a particular device and you remove the device from the link, open the link to the device, or open the link to add a new device, your application might not recognize the change and may not work as expected.

---

Device Name	Path Name	File Type	Major Number	Minor Number	Power Req.
HP 46082A/B	—	—	—	—	33 mA

---

# Installing the HP 46083A Rotary Control Knob

## Description

The HP 46083A provides 2-axis relative cursor positioning via a rotary knob and 2-axis toggle button. It is best suited for text editing and spreadsheet applications. The HP 46083A connects to your computer via the HP-HIL interface.

## Support

The HP 46083A Rotary Control Knob is supported on Series 200 Model 217, 220 (with the optional HP-HIL interface installed) and Model 237 computers, and on all Series 300 computers.

Operating/Language systems support is as follows:

- **BASIC:** supported on revision 3.0 or later with Series 200 computers; supported on revision 4.0 or later with Series 300 computers.
- **Pascal Workstation:** supported on revision 3.0 or later with Series 200 computers; supported on revision 3.1 or later with Series 300 computers.
- **HP-UX Operating System:** supported on revision 5.1 or later with Series 200 computers; supported on revision 5.0 or later with Series 300 computers.

## HP 46083A Rotary Control Knob Installation Procedure

---

### NOTE

Connecting and disconnecting HP-HIL devices while some language/operating systems or application programs are running may lead to unpredictable results. When possible, connect all needed HP-HIL devices to your computer before booting a language/operating system or running an application program.

---

1. Find the HP-HIL cable that came with the rotary control knob.
2. Find the end of the cable that is marked with one black dot.
3. Find the HP-HIL connector on the rotary control knob that is marked with one dot.

4. Plug the “one-dot” end of the cable into the “one-dot” connector on the rotary control knob.
  5. Connect the other, “two-dot” end of the cable into the HP-HIL connector on your computer (marked “KYBD” or “KEYBOARD”), or to the “two-dot” connector of the last HP-HIL device you installed (e.g. keyboard).
  6. Keep these constraints in mind:
    - You cannot have more than 7 HP-HIL addressable devices connected to your computer at one time. The HP 46080A, 46081A, 46082A and 46082B Extension modules and the HP 46089A Four-Button Cursor do not count as addressable devices, and the HP 46085A Control Dials Module counts as *three* addressable devices. All other devices count as one addressable device.
    - The current requirements of all of your devices must not exceed 750 milliamps (mA). To make sure you do not exceed this requirement, total up the typical power required by each of your HP-HIL devices as given in the following “Worksheet Entries” sections. If the total exceeds 750 mA, you must remove one or more devices.
- 

## The Next Step

You have now installed your HP 46083A Rotary Control Knob.

The following “Worksheet Entries” contain information needed to use your rotary control knob with various language/operating systems. Refer to the entries for the system you’ll be using (BASIC, Pascal or HP-UX).

Copy this information to a worksheet (worksheets are found at the end of Step 1) or remember to refer here when you need it.

When finished, you’ll be ready to install your next peripheral. If you have installed all of your peripherals, refer to the *User’s Guide* that came with your operating/language system.



---

## BASIC System Worksheet Entry

---

### CAUTION

New devices added to the HP-HIL interface while the BASIC system is running will not be recognized until a SCRATCH A command is executed. Also, data received from the HP-HIL interface may be garbled if the order of devices is changed while the system is running.

---

Device Name	Device Selector	Digitizer Specifier	Power Req.
HP 46083A	KBD	"KBD"	73 mA

---

## Pascal Workstation Worksheet Entry

---

### CAUTION

Connecting or disconnecting HP-HIL devices while the Pascal Workstation is running may hang the system. The *only* times when you may safely connect or disconnect an HP-HIL device is when the system's power is off, or while the system's command line is being displayed *and* the time/date display (from the Version command) is not being displayed.

---

Device Name	Device Selector	Module Name	Power Req.
HP 46083A	2	HPHIL & MOUSE	73 mA

---

# HP-UX System Worksheet Entries

---

## NOTE

HP-HIL devices can be added to or removed from the HP-HIL interface without affecting the HP-UX operating system. However, if your application requires the use of a particular device and you remove the device from the link, open the link to the device, or open the link to add a new device, your application might not recognize the change and may not work as expected.

---

Device Name	Path Name	File Type	Major Number	Minor <sup>1</sup> Number	Power Req.
HP 46083A	<i>/dev/r8042</i>	c	23	0x000000	73 mA
HP 46083A	<i>/dev/knob</i>	c	24	0x000020	73 mA

---

<sup>1</sup> The second minor number in the table assumes the rotary control knob is the second device on the HP-HIL interface (address=2). If this is not the case, substitute the correct position (address) of the rotary control knob in place of the **2** in the minor number (e.g., if the rotary control knob is the third device on the interface, the minor number would be 0x000030).

---

# Installing the HP 46084A ID Module

## Description

The HP 46084A ID Module contains a unique, machine-readable serial number required by software which uses HP's "Codeword Delivery" security scheme (e.g., HP 98305A HP EGS), or software which is customized to an HP 46084A. It connects to your computer via the HP-HIL interface.

## Support

The HP 46084A ID Module is supported on Series 200 Model 217, 220 (with the optional HP-HIL interface installed) and Model 237 computers, and on all Series 300 computers.

Operating/Language systems support is as follows:

- **BASIC:** supported on revision 3.0 or later with Series 200 computers; supported on revision 4.0 or later with Series 300 computers.
- **Pascal Workstation:** supported only at a special time and materials charge. Contact your HP Sales and Service office for details.
- **HP-UX Operating System:** supported on revision 5.1 or later with Series 200 computers; supported on revision 5.0 or later with Series 300 computers.

## HP 46084A ID Module Installation Procedure

---

### NOTE

Connecting and disconnecting HP-HIL devices while some language/operating systems or application programs are running may lead to unpredictable results. When possible, connect all needed HP-HIL devices to your computer before booting a language/operating system or running an application program.

---

1. Find the HP-HIL cable that came with the ID Module.
2. Find the end of the cable that is marked with one black dot.
3. Find the HP-HIL connector on the ID Module that is marked with one dot.
4. Plug the “one-dot” end of the cable into the “one-dot” connector on the ID Module.
5. Connect the other, “two-dot” end of the cable into the HP-HIL connector on your computer (marked “KYBD” or “KEYBOARD”), or to the “two-dot” connector of the last HP-HIL device you installed (e.g. keyboard).
6. Keep these constraints in mind:
  - You cannot have more than 7 HP-HIL addressable devices connected to your computer at one time. The HP 46080A, 46081A, 46082A and 46082B Extension modules and the HP 46089A Four-Button Cursor do not count as addressable devices, and the HP 46085A Control Dials Module counts as *three* addressable devices. All other devices count as one addressable device.
  - The current requirements of all of your devices must not exceed 750 milliamps (mA). To make sure you do not exceed this requirement, total up the typical power required by each of your HP-HIL devices as given in the following “Worksheet Entries” sections. If the total exceeds 750 mA, you must remove one or more devices.

---

## The Next Step

You have now installed your HP 46084A ID Module.

The following "Worksheet Entries" contain information needed to use your ID Module with various language/operating systems. Refer to the entries for the system you'll be using (BASIC, Pascal or HP-UX).

Copy this information to a worksheet (worksheets are found at the end of Step 1) or remember to refer here when you need it.

When finished, you'll be ready to install your next peripheral. If you have installed all of your peripherals, refer to the *User's Guide* that came with your operating/language system.

---

## BASIC System Worksheet Entry

---

### NOTE

To read the ID Module, execute this command:

```
SYSTEM$( "SERIAL NUMBER" )
```

---

---

### CAUTION

New devices added to the HP-HIL interface while the BASIC system is running will not be recognized until a SCRATCH A command is executed. Also, data received from the HP-HIL interface may be garbled if the order of devices is changed while the system is running.

---

Device Name	Device Selector	Digitizer Specifier	Power Req.
HP 46084A	—	—	40 mA

---

## Pascal Workstation Worksheet Entry

---

### CAUTION

Connecting or disconnecting HP-HIL devices while the Pascal Workstation is running may hang the system. The *only* times when you may safely connect or disconnect an HP-HIL device is when the system's power is off, or while the system's command line is being displayed *and* the time/date display (from the Version command) is not being displayed.

---

### NOTE

Pascal Workstation support is available for a special time and materials charge. Contact your HP Sales Representative for details.

---

---

## HP-UX System Worksheet Entries

---

### NOTE

HP-HIL devices can be added to or removed from the HP-HIL interface without affecting the HP-UX operating system. However, if your application requires the use of a particular device and you remove the device from the link, open the link to the device, or open the link to add a new device, your application might not recognize the change and may not work as expected.

---

Device Name	Path Name	File Type	Major No.	Minor No. <sup>1</sup>	Power Req.
HP 46084A	/dev/r8042	c	23	0x000000	40 mA
HP 46084A	/dev/security	c	24	0x000020	40 mA

<sup>1</sup> The second minor number in the table assumes the ID Module is the second device on the HP-HIL interface (address=2). If this is not the case, substitute the correct position (address) of the ID Module in place of the 2 in the minor number (e.g., if the ID Module is the third device on the interface, the minor number would be 0x000030).

---

# Installing the HP 46085A Control Dials Module

## Description

The HP 46085A Control Dials Module provides nine graphics positioning devices, implemented as three 3-axis devices. The control dials module is commonly used in graphics display applications to provide 3-axis attitude, 3-axis translation, scaling and other attribute functions. It connects to your computer via the HP-HIL interface and occupies 3 addresses.

## Support

The HP 46085A Control Dials Module is supported on all Series 300 computers.

Operating/Language systems support is as follows:

- **BASIC:** supported on revision 5.0 or later with Series 300 computers.
- **Pascal Workstation:** not supported.
- **HP-UX Operating System:** supported on revision 5.0 or later with Series 300 computers.

## HP 46085A Control Dials Module Installation Procedure

---

### NOTE

Connecting and disconnecting HP-HIL devices while some language/operating systems or application programs are running may lead to unpredictable results. When possible, connect all needed HP-HIL devices to your computer before booting a language/operating system or running an application program.

---

1. Find the HP-HIL cable that came with the control dials module.
2. Find the end of the cable that is marked with one black dot.
3. Find the HP-HIL connector on the control dials module that is marked with one dot.
4. Plug the “one-dot” end of the cable into the “one-dot” connector on the control dials module.

5. Connect the other, “two-dot” end of the cable into the HP-HIL connector on your computer (marked “KYBD” or “KEYBOARD”), or to the “two-dot” connector of the last HP-HIL device you installed (e.g. keyboard).
  6. Keep these constraints in mind:
    - You cannot have more than 7 HP-HIL addressable devices connected to your computer at one time. The HP 46080A, 46081A, 46082A and 46082B Extension modules and the HP 46089A Four-Button Cursor do not count as addressable devices, and the HP 46085A Control Dials Module counts as *three* addressable devices. All other devices count as one addressable device.
    - The current requirements of all of your devices must not exceed 750 milliamps (mA). To make sure you do not exceed this requirement, total up the typical power required by each of your HP-HIL devices as given in the following “Worksheet Entries” sections. If the total exceeds 750 mA, you must remove one or more devices.
- 

## The Next Step

You have now installed your HP 46085A Control Dials Module.

The following “Worksheet Entries” contain information needed to use your control dials module with various languages/operating systems. Refer to the entries for the system you’ll be using (BASIC or HP-UX).

Copy this information to a worksheet (worksheets are found at the end of Step 1) or remember to refer here when you need it.

When finished, you’ll be ready to install your next peripheral. If you have installed all of your peripherals, refer to the *User’s Guide* that came with your HP-UX operating system.



---

## BASIC System Worksheet Entry

---

### NOTE

To access the full capabilities of the Control Dials Module, use the ON CDIAL statement and the CDIAL function.

---

### CAUTION

New devices added to the HP-HIL interface while the BASIC system is running will not be recognized until a SCRATCH A command is executed. Also, data received from the HP-HIL interface may be garbled if the order of devices is changed while the system is running.

---

Device Name	Device Selector	Digitizer Specifier	Power Req.
HP 46085A	KBD	"KBD"	213mA

---

# HP-UX System Worksheet Entries

---

## NOTE

HP-HIL devices can be added to or removed from the HP-HIL interface without affecting the HP-UX operating system. However, if your application requires the use of a particular device and you remove the device from the link, open the link to the device, or open the link to add a new device, your application might not recognize the change and may not work as expected.

---

<b>Device Name</b>	<b>Path Name</b>	<b>File Type</b>	<b>Major Number</b>	<b>Minor<sup>1</sup> Number</b>	<b>Power Req.</b>
HP 46085A	<i>/dev/r8042</i>	c	23	0x000000	213mA
HP 46085A	<i>/dev/dial.top</i>	c	24	0x000020	213mA
HP 46085A	<i>/dev/dial.mid</i>	c	24	0x000030	213mA
HP 46085A	<i>/dev/dial.bot</i>	c	24	0x000040	213mA

---

<sup>1</sup> The second, third and fourth minor numbers in the table assume the control dials module is the second device on the HP-HIL interface, thus occupying addresses 2, 3 and 4. If this is not the case, substitute the correct position (address) of the control dials module in place of the 2 in the second minor number, and change the third and fourth minor numbers accordingly (e.g., if the device is the fourth device on the interface, the last three minor numbers would be 0x000040, 0x000050 and 0x000060, respectively).

---

# Installing the HP 46086A Button Box

## Description

The HP 46086A Button Box provides 32 user-definable buttons for menu selection, and one user-programmable LED. Buttons can be labeled with defined functions, freeing the display for other uses. It includes one pre-printed and two blank overlays, and connects to your computer via the HP-HIL interface.

## Support

The HP 46086A Button Box is supported on all Series 300 computers.

Operating/Language systems support is as follows:

- **BASIC:** supported on revision 5.0 or later with Series 300 computers.
- **Pascal Workstation:** not supported.
- **HP-UX Operating System:** supported on revision 5.0 or later with Series 300 computers.

## HP 46086A Button Box Installation Procedure

---

### NOTE

Connecting and disconnecting HP-HIL devices while some language/operating systems or application programs are running may lead to unpredictable results. When possible, connect all needed HP-HIL devices to your computer before booting a language/operating system or running an application program.

---

1. Find the HP-HIL cable that came with the button box.
2. Find the end of the cable that is marked with one black dot.
3. Find the HP-HIL connector on the button box that is marked with one dot.
4. Plug the “one-dot” end of the cable into the “one-dot” connector on the button box.

5. Connect the other, “two-dot” end of the cable into the HP-HIL connector on your computer (marked “KYBD” or “KEYBOARD”), or to the “two-dot” connector of the last HP-HIL device you installed (e.g. keyboard).
  6. Keep these constraints in mind:
    - You cannot have more than 7 HP-HIL addressable devices connected to your computer at one time. The HP 46080A, 46081A, 46082A and 46082B Extension modules and the HP 46089A Four-Button Cursor do not count as addressable devices, and the HP 46085A Control Dials Module counts as *three* addressable devices. All other devices count as one addressable device.
    - The current requirements of all of your devices must not exceed 750 milliamps (mA). To make sure you do not exceed this requirement, total up the typical power required by each of your HP-HIL devices as given in the following “Worksheet Entries” sections. If the total exceeds 750 mA, you must remove one or more devices.
- 

## The Next Step

You have now installed your HP 46086A Button Box.

The following “Worksheet Entries” contain information needed to use your button box with various languages/operating systems. Refer to the entries for the system you’ll be using (BASIC or HP-UX).

Copy this information to a worksheet (worksheets are found at the end of Step 1) or remember to refer here when you need it.

When finished, you’ll be ready to install your next peripheral. If you have installed all of your peripherals, refer to the *User’s Guide* that came with your HP-UX operating system.

---

## BASIC System Worksheet Entry

---

### NOTE

To use the Button Box, use the ON HIL EXT statement, the HILBUF\$ function, and the HIL SEND statement.

---

### CAUTION

New devices added to the HP-HIL interface while the BASIC system is running will not be recognized until a SCRATCH A command is executed. Also, data received from the HP-HIL interface may be garbled if the order of devices is changed while the system is running.

---

Device Name	Device Selector	Digitizer Specifier	Power Req.
HP 46086A		—	53mA

---

## HP-UX System Worksheet Entries

---

### NOTE

HP-HIL devices can be added to or removed from the HP-HIL interface without affecting the HP-UX operating system. However, if your application requires the use of a particular device and you remove the device from the link, open the link to the device, or open the link to add a new device, your application might not recognize the change and may not work as expected.

---

Device Name	Path Name	File Type	Major Number	Minor <sup>1</sup> Number	Power Req.
HP 46086A	<i>/dev/r8042</i>	c	23	0x000000	53 mA
HP 46086A	<i>/dev/buttons</i>	c	24	0x000020	53 mA

---

<sup>1</sup> The second minor number in the table assumes the button box is the second device on the HP-HIL interface (address=2). If this is not the case, substitute the correct position (address) of the button box in place of the **2** in the minor number (e.g., if the button box is the third device on the interface, the minor number would be 0x000030).

---

# Installing the HP 46087/88A Digitizers and HP 46089A Cursor

## Description

The HP 46087A and 46088A are low-cost, high-resolution digitizers suitable for menu/object picking, free-hand graphics entry and digitizing. The HP 46087A is ANSI A/ISO A4 size. The HP 46088A is ANSI B/ISO A3. Both digitizers include a stylus with tip switch and a platen overlay. Both digitizers connect to your computer via the HP-HIL interface.

The HP 46089A four-button, cross-hair cursor is available separately or as digitizer Option 001. The cursor is recommended for digitizing existing drawings, artwork or other hard-copy images. It uses no additional power and occupies no HP-HIL addresses.

## Support

The HP 46087/88/89A are supported on Series 200 Model 217 and 237 computers, and on all Series 300 computers.

Operating/Language systems support is as follows:

- **BASIC:** supported on revision 4.0 or later with both Series 200 and Series 300 computers.
- **Pascal Workstation:** supported on revision 3.1 or later with both Series 200 and Series 300 computers.
- **HP-UX Operating System:** supported on revision 5.1 or later with Series 200 computers; supported on revision 5.0 or later with Series 300 computers.

## HP 46087/88A Digitizer and HP 46089A Cursor Installation Procedure

---

### NOTE

Connecting and disconnecting HP-HIL devices while some language/operating systems or application programs are running may lead to unpredictable results. When possible, connect all needed HP-HIL devices to your computer before booting a language/operating system or running an application program.

---

1. Find the HP-HIL cable that came with the digitizer.
2. Find the end of the cable that is marked with one black dot.
3. Find the HP-HIL connector on the digitizer that is marked with one dot.
4. Plug the “one-dot” end of the cable into the “one-dot” connector on the digitizer.
5. Connect the other, “two-dot” end of the cable into the HP-HIL connector on your computer (marked “KYBD” or “KEYBOARD”), or to the “two-dot” connector of the last HP-HIL device you installed (e.g. keyboard).
6. Plug the stylus or HP 46089A Cursor into the round connector on the digitizer.
7. Keep these constraints in mind:
  - You cannot have more than 7 HP-HIL addressable devices connected to your computer at one time. The HP 46080A, 46081A, 46082A and 46082B Extension modules and the HP 46089A Four-Button Cursor do not count as addressable devices, and the HP 46085A Control Dials Module counts as *three* addressable devices. All other devices count as one addressable device.
  - The current requirements of all of your devices must not exceed 750 milliamps (mA). To make sure you do not exceed this requirement, total up the typical power required by each of your HP-HIL devices as given in the following “Worksheet Entries” sections. If the total exceeds 750 mA, you must remove one or more devices.



---

## The Next Step

You have now installed your HP 46087/88 Digitizer and your HP 46089A Cursor.

The following “Worksheet Entries” contain information needed to use your digitizer with various language/operating systems. Refer to the entries for the system you’ll be using (BASIC, Pascal or HP-UX).

Copy this information to a worksheet (worksheets are found at the end of Step 1) or remember to refer here when you need it.

When finished, you’ll be ready to install your next peripheral. If you have installed all of your peripherals, refer to the *User’s Guide* that came with your operating/language system.

---

## BASIC System Worksheet Entry

---

### CAUTION

New devices added to the HP-HIL interface while the BASIC system is running will not be recognized until a SCRATCH A command is executed. Also, data received from the HP-HIL interface may be garbled if the order of devices is changed while the system is running.

---

Device Name	Device Selector	Digitizer Specifier	Power Req.
HP 46087/88/89A	KBD	“TABLET”	133 mA

---

## Pascal Workstation Worksheet Entry

---

### CAUTION

Connecting or disconnecting HP-HIL devices while the Pascal Workstation is running may hang the system. The *only* times when you may safely connect or disconnect an HP-HIL device is when the system's power is off, or while the system's command line is being displayed *and* the time/date display (from the Version command) is not being displayed.

---

Device Name	Device Selector	Module Name	Power Req.
HP 46087/88/89A	201	HPHIL & DGL_ABS	133 mA

---

## HP-UX System Worksheet Entries

---

### NOTE

HP-HIL devices can be added to or removed from the HP-HIL interface without affecting the HP-UX operating system. However, if your application requires the use of a particular device and you remove the device from the link, open the link to the device, or open the link to add a new device, your application might not recognize the change and may not work as expected.

---

Device Name	Path Name	File Type	Major No.	Minor No. <sup>1</sup>	Power Req.
HP 46087/88/89A	/dev/r8042	c	23	0x000000	133 mA
HP 46087/88/89A	/dev/digitizer	c	24	0x000020	133 mA

---

<sup>1</sup> The second minor number in the table assumes the digitizer is the second device on the HP-HIL interface (address=2). If this is not the case, substitute the correct position (address) of the digitizer in place of the 2 in the minor number (e.g., if the digitizer is the third device on the interface, the minor number would be 0x000030).

---

# Installing the HP 46094A Quadrature Port

## Description

The HP 46094A Quadrature Port is used to connect an off-the-shelf three-button mouse or other compatible device to the HP-HIL interface.

## Support

Check with your local HP Sales and Service office for support information.

## HP 46094A Quadrature Port Installation Procedure

---

### NOTE

Connecting and disconnecting HP-HIL devices while some language/operating systems or application programs are running may lead to unpredictable results. When possible, connect all needed HP-HIL devices to your computer before booting a language/operating system or running an application program.

---

1. Select a suitable mounting location for the quadrature port. Remove the paper backing from the back of the fastener pad. Place the pad at the location and press down firmly for a few seconds. Slide the module unit onto the fastener pad from the side and twist the module unit a few degrees to lock it onto the fastener pad.
2. Find the end of the HP-HIL cable that is marked with one black dot.
3. Find the connector on the back of the quadrature port that is marked with one dot.
4. Plug the “one-dot” end of the cable into the “one-dot” connector on the quadrature port.
5. Connect the other, “two-dot” end of the cable into the HP-HIL connector on your computer (marked “KYBD” or “KEYBOARD”), or to the “two-dot” connector of the last HP-HIL device you installed (e.g., keyboard).
6. Connect the 3-button mouse (or other compatible device) to the 9-pin D-subminiature connector on the quadrature port and fasten the two screws with a screwdriver.

7. Keep these constraints in mind:

- You cannot have more than 7 HP-HIL addressable devices connected to your computer at one time. The HP 46080A, 46081A, 46082A and 46082B Extension modules and the HP 46089A Four-Button Cursor do not count as addressable devices, and the HP 46085A Control Dials Module counts as *three* addressable devices. All other devices count as one addressable device.
- The current requirements of all of your devices must not exceed 750 milliamps (mA). To make sure you do not exceed this requirement, total up the typical power required by each of your HP-HIL devices as given in the following “Worksheet Entries” sections. If the total exceeds 750 mA, you must remove one or more devices.

---

## The Next Step

You have now installed your HP 46094A Quadrature Port.

The following “Worksheet Entries” contain information needed to use your HP 46094A with various language/operating systems. Refer to the entries for the system you’ll be using (BASIC, Pascal or HP-UX).

Copy this information to a worksheet (worksheets are found at the end of Step 1) or remember to refer here when you need it.

When finished, you’ll be ready to install your next peripheral. If you have installed all of your peripherals, refer to the *User’s Guide* that came with your operating/language system.

---

## BASIC System Worksheet Entry

---

### CAUTION

New devices added to the HP-HIL interface while the BASIC system is running will not be recognized until a SCRATCH A command is executed. Also, data received from the HP-HIL interface may be garbled if the order of devices is changed while the system is running.

---

Device Name	Device Selector	Digitizer Specifier	Power Req.
HP 46094A	KBD	"KBD"	125 mA

---

## Pascal Workstation Worksheet Entry

---

### CAUTION

Connecting or disconnecting HP-HIL devices while the Pascal Workstation is running may hang the system. The *only* times when you may safely connect or disconnect an HP-HIL device is when the system's power is off, or while the system's command line is being displayed *and* the time/date display (from the Version command) is not being displayed.

---

Device Name	Device Selector	Module Name	Power Req.
HP 46094A	2	HPHIL & MOUSE	125 mA

---

## HP-UX System Worksheet Entries

---

### NOTE

HP-HIL devices can be added to or removed from the HP-HIL interface without affecting the HP-UX operating system. However, if your application requires the use of a particular device and you remove the device from the link, open the link to the device, or open the link to add a new device, your application might not recognize the change and may not work as expected.

---

Device Name	Path Name	File Type	Major Number	Minor <sup>1</sup> Number	Power Req.
HP 46094A	<i>/dev/r8042</i>	c	23	0x000000	125 mA
HP 46094A	<i>/dev/quad</i>	c	24	0x000020	125 mA

---

<sup>1</sup> The second minor number in the table assumes the quadrature port is the second device on the HP-HIL interface (address=2). If this is not the case, substitute the correct position (address) of the quadrature port in place of the **2** in the minor number (e.g., if the quadrature port is the third device on the interface, the minor number would be 0x000030).

---

# Installing the HP 6944A Multiprogrammer

## Description

The HP 6944A Multiprogrammer connects to your computer via the HP 98633A Interface.

## Support

The HP 6944A Multiprogrammer is supported on Series 200 Model 216, 220, 226, 236 and 237 computers.

Operating/Language system support is as follows:

- **BASIC:** supported on revision 2.1 or later with Series 200 computers, but only with the HP 14752A Multiprogrammer software pack.
- **Pascal Workstation:** not supported.
- **HP-UX Operating System:** not supported.

## Before You Begin

The following procedure describes how to connect the HP 6944A Multiprogrammer to your computer. Before you do this, however, refer to the manual that came with the multiprogrammer to:

- Unpack the multiprogrammer.
- Check the line voltage label and fuses.

## **HP 6944A Multiprogrammer Installation Procedure**

1. **Turn your computer off.**
2. Set the frame address switch, located on the back of the multiprogrammer.
  - If you have only one HP 6944A Multiprogrammer on each HP 98633A Interface, do nothing—the frame address is already set properly (to 0).
  - If you have more than one HP 6944A Multiprogrammer on each HP 98633A Interface, use a small screw driver to set the Frame Address Switch of each multiprogrammer to a different value.
3. Check the Logic Ground Switch.
  - If you have only one HP 6944A Multiprogrammer on each HP 98633A Interface, do nothing.
  - If you have more than one HP 6944A Multiprogrammer on each HP 98633A Interface, refer to the multiprogrammer's installation manual for instructions on setting the Logic Ground Switch.
4. Insert all I/O cards into the multiprogrammer. Record the following information for each card:
  - Card type and model number
  - Frame address of the multiprogrammer in which the card is installed.
  - Slot address (0-15) of the card.
  - The purpose of the card in the application.
5. Connect the multiprogrammer interface cable from the HP 98633A Interface connector to the BUS IN connector in the multiprogrammer, and install the termination plug in the BUS OUT connector. If connecting more than one multiprogrammer in a link, connect the next interface cable from the BUS OUT connector in the previous multiprogrammer to the BUS IN connector of the next multiprogrammer.
6. Connect the power cord to the multiprogrammer and plug it into the power outlet.



---

## The Next Step

You have now installed your multiprogrammer.

The following “Worksheet Entry” contains information needed to use your multiprogrammer with BASIC.

Copy this information to a worksheet (worksheets are found at the end of Step 1) or remember to refer here when you need it.

When finished, you’ll be ready to install your next peripheral. If you have installed all of your peripherals, refer to the *User’s Guide* that came with your operating/language system.

---

## BASIC System Worksheet Entry

Device Name	Device Selector <sup>1</sup>
HP 6944A	29

---

<sup>1</sup> If you changed the select code of the HP 98633A Multiprogrammer Interface, write in the new select code instead of 29.

---

# Installing the HP 92205A/C Hayes Smartmodem 1200

## Description

The HP 92205A/C Hayes *Smartmodem 1200* connects to your computer via an RS-232C interface.

## Support

The HP 92205A/C Hayes *Smartmodem 1200* is supported on Series 200 Model 217, 220, 226, 236 and 237 computers, and on all Series 300 computers.

Operating/Language system support is as follows:

- **BASIC:** supported on revision 2.1 or later with Series 200 computers; supported on revision 4.0 or later with Series 300 computers.
- **Pascal Workstation:** supported on revision 3.0 or later with Series 200 computers; supported on revision 3.1 or later with Series 300 computers. Support requires user-written software or a terminal emulator software package.
- **HP-UX Operating System:** supported on revision 2.1 or later with Series 200 computers; supported on revision 5.0 or later with Series 300 computers.

## Before You Begin

The following procedure describes how to connect the *Smartmodem 1200* to your computer. Before you do this, however, refer to the manual that came with the modem to:

- Unpack the modem.
- Contact the telephone company.

## **Smartmodem 1200 Installation Procedure**

### **1. Play It Safe.**

- a. Turn your computer and modem off, if they are not already off.

### **2. Connect the Telephone Cable.**

- a. With the gold contacts up, plug one end of the modular telephone cable into the telephone connector on the back of the modem.
- b. Insert the remaining end of the telephone cable into a telephone wall jack.

### **3. Select Your Interface and Cable.**

- a. The modem can be connected to any of the following RS-232C interfaces:
  - Series 200 Model 216 or 217 built-in “Data Communications” interface—use an HP 5061-4215 DTE cable.
  - Series 300 built-in RS-232C interface—use an HP 13242N or 92221M cable.
  - HP 98626A RS-232C Interface—use an HP 5061-4215 (Option 001 DTE) cable.
  - HP 98628A Datacomm Interface—use an HP 5061-4215 (Option 001 DTE) cable.
  - HP 98642A 4-Channel Multiplexer Interface, port 0 (HP-UX only)—use an HP 92219S, 92218A or 92222M cable. Ports 1, 2 and 3 are not recommended for use with the modem.
  - HP 98644A RS-232C Serial Interface—use an HP 13242N, 92218A or 92222M cable.

### **4. Connect the Modem to Your Computer.**

- a. Connect the cable between the modem and the interface.

### **5. Connect the Power Cord.**

- a. Connect the power cord into the power connector on the back of the modem, and plug the other end into your power outlet.

---

## The Next Step

You have now installed your modem.

The following “Worksheet Entries” contain information needed to use your modem with various language/operating systems. Refer to the entries for the system you’ll be using (BASIC, Pascal or HP-UX).

Copy this information to a worksheet (worksheets are found at the end of Step 1) or remember to refer here when you need it.

When finished, you’ll be ready to install your next peripheral. If you have installed all of your peripherals, refer to the *User’s Guide* that came with your operating/language system.

---

## BASIC System Worksheet Entries

---

### IMPORTANT!

If you have connected the modem to a Series 300 built-in or HP 98644A Interface, execute the following statement before using the modem to set the baud rate of the interface to 1200:

```
CONTROL 9,13;1200
```

This statement assumes an interface select code of 9. If your select code is different, substitute your select code for 9 in the statement above.

Additional programming of interface registers may be required before communication can proceed. Consult your *BASIC Interfacing Techniques* manual for details.

---

Device Name	Device Selector <sup>1</sup>
<i>Smartmodem 1200</i>	9

---

<sup>1</sup> If you connected your modem to an interface with a select code other than 9, write in your select code instead of 9.

---

## Pascal Workstation Worksheet Entry

Device Name	Device Selector <sup>1</sup>
<i>Smartmodem 1200</i>	9

---

## HP-UX System Worksheet Entries

If You Connected the Modem to a Model 216, Model 217,  
or Series 300 Built-in Interface (Select Code 9)...

Device Name	Path Name <sup>2</sup>	File Type	Major No.	Minor No.
<i>Smartmodem</i>	<i>/dev/tty02</i>	c	1	0x090000
<i>Smartmodem</i>	<i>/dev/cua02</i>	c	1	0x090001
<i>Smartmodem</i>	<i>/dev/cul02</i>	c	1	0x090001

---

<sup>1</sup> If you connected your modem to an interface with a select code other than 9, write in your select code instead of 9.

<sup>2</sup> The path names given here assume this is the second terminal or modem you are connecting (i.e., *tty02*). If this is not the case, change the path names accordingly (e.g., */dev/tty03* for the third modem, etc.).

---

## HP-UX System Worksheet Entries (Cont.)

If You Connected the Modem to an HP 98626A, 98628A, 98642A or 98644A Interface (Select Code 9, 10, 13, 15, 16, 17, 19 or 20)...

Device Name	Path Name <sup>1</sup>	File Type	Major No.	Minor No.
<i>Smartmodem</i> , select code 9	<i>/dev/tty02</i>	c	1	0x090000
<i>Smartmodem</i> , select code 9	<i>/dev/cua02</i>	c	1	0x090001
<i>Smartmodem</i> , select code 9	<i>/dev/cul02</i>	c	1	0x090001
<i>Smartmodem</i> , select code 10	<i>/dev/tty02</i>	c	1	0x0a0000
<i>Smartmodem</i> , select code 10	<i>/dev/cua02</i>	c	1	0x0a0001
<i>Smartmodem</i> , select code 10	<i>/dev/cul02</i>	c	1	0x0a0001
<i>Smartmodem</i> , select code 13	<i>/dev/tty02</i>	c	1	0x0d0000
<i>Smartmodem</i> , select code 13	<i>/dev/cua02</i>	c	1	0x0d0001
<i>Smartmodem</i> , select code 13	<i>/dev/cul02</i>	c	1	0x0d0001
<i>Smartmodem</i> , select code 15	<i>/dev/tty02</i>	c	1	0x0f0000
<i>Smartmodem</i> , select code 15	<i>/dev/cua02</i>	c	1	0x0f0001
<i>Smartmodem</i> , select code 15	<i>/dev/cul02</i>	c	1	0x0f0001
<i>Smartmodem</i> , select code 16	<i>/dev/tty02</i>	c	1	0x100000
<i>Smartmodem</i> , select code 16	<i>/dev/cua02</i>	c	1	0x100001
<i>Smartmodem</i> , select code 16	<i>/dev/cul02</i>	c	1	0x100001
<i>Smartmodem</i> , select code 17	<i>/dev/tty02</i>	c	1	0x110000
<i>Smartmodem</i> , select code 17	<i>/dev/cua02</i>	c	1	0x110001
<i>Smartmodem</i> , select code 17	<i>/dev/cul02</i>	c	1	0x110001
<i>Smartmodem</i> , select code 19	<i>/dev/tty02</i>	c	1	0x130000
<i>Smartmodem</i> , select code 19	<i>/dev/cua02</i>	c	1	0x130001
<i>Smartmodem</i> , select code 19	<i>/dev/cul02</i>	c	1	0x130001
<i>Smartmodem</i> , select code 20	<i>/dev/tty02</i>	c	1	0x140000
<i>Smartmodem</i> , select code 20	<i>/dev/cua02</i>	c	1	0x140001
<i>Smartmodem</i> , select code 20	<i>/dev/cul02</i>	c	1	0x140001

---

<sup>1</sup> The path names here assume this is the second terminal or modem you are connecting (i.e., *tty02*). If this is not the case, change the path names accordingly (e.g., */dev/tty03* for the third modem, etc.).

---

# Installing the HP 92916A Bar Code Reader

## Description

The HP 92916A is a general-purpose bar code reader. It connects to your computer via the HP-HIL interface.

## Support

The HP 92916A bar code reader is supported on Series 200 Model 217, 220 and 237 computers, and on all Series 300 computers.

Operating/Language systems support is as follows:

- **BASIC:** supported on revision 3.0 or later with Series 200 computers; supported on revision 4.0 or later with Series 300 computers.
- **Pascal Workstation:** supported on revision 3.0 or later with Series 200 computers; supported on revision 3.1 or later with Series 300 computers.
- **HP-UX Operating System:** supported on revision 2.1 or later with Series 200 computers; supported on revision 5.0 or later with Series 300 computers.

## HP 92916A Bar Code Reader Installation Procedure

---

### NOTE

Connecting and disconnecting HP-HIL devices while some language/operating systems or application programs are running may lead to unpredictable results. When possible, connect all needed HP-HIL devices to your computer before booting a language/operating system or running an application program.

---

1. Find the HP-HIL cable that came with the bar code reader.
2. Find the end of the cable that is marked with one black dot.
3. Find the HP-HIL connector on the bar code reader that is marked with one dot.

4. Plug the “one-dot” end of the cable into the “one-dot” connector on the bar code reader.
5. Connect the other, “two-dot” end of the cable into the HP-HIL connector on your computer (marked “KYBD” or “KEYBOARD”), or to the “two-dot” connector of the last HP-HIL device you installed (e.g. keyboard).

---

**IMPORTANT!**

Connect your HP 46020/21 keyboard to the HP-HIL interface before connecting the bar code reader. The keyboard must be “up-stream” from the bar code reader in the chain of HP-HIL devices.<sup>1</sup>

---

6. Connect the wand to the bar code reader.
7. Set the Configuration Switches:
  - a. Set the code selection switches, 1 through 3, according to your application:

Definition	Switch 1	Switch 2	Switch 3
Interleaved 2/5	0	0	1
Codebar ABC	0	1	0
Codabar USD-4	0	1	1
UPC/EAN/JAN	1	0	0
Code 39	1	0	1

- b. Set the transmission type switch, 4, to “Keycode” by setting it to **1**.
  - c. Set the keyboard selection switches, 5 through 8, according to which keyboard you have. Set all switches to **0** for a US ASCII keyboard. Refer to the manual that came with your bar code reader for additional settings.
  - d. Set the appended control switches, 9 and 10, to select Return by setting switch 9 to **0** and switch 10 to **1**.

---

<sup>1</sup> If you don't want the bar code reader to be a keyboard, and you are using BASIC 5.0 or later, use the other setting in step 7-b. In this case, it's unnecessary for the keyboard to precede the bar code reader, and other settings are acceptable in step 7-d.



- e. Set the check digit switch, 11, to off (**0**) or on (**1**) depending on your application. This switch has no meaning in UPC/EAN applications.
  - f. Set the field length check switches, 12 through 16, to off (all **0**) unless your application requires a different setting.
8. Keep these constraints in mind:
- You cannot have more than 7 HP-HIL addressable devices connected to your computer at one time. The HP 46080A, 46081A, 46082A and 46082B Extension modules and the HP 46089A Four-Button Cursor do not count as addressable devices, and the HP 46085A Control Dials Module counts as *three* addressable devices. All other devices count as one addressable device.
  - The current requirements of all of your devices must not exceed 750 milliamps (mA). To make sure you do not exceed this requirement, total up the typical power required by each of your HP-HIL devices as given in the following “Worksheet Entries” sections. If the total exceeds 750 mA, you must remove one or more devices.

---

## The Next Step

You have now installed your HP 92916A Bar Code Reader.

The following “Worksheet Entries” contain information needed to use your bar code reader with various language/operating systems. Refer to the entries for the system you’ll be using (BASIC, Pascal or HP-UX).

Copy this information to a worksheet (worksheets are found at the end of Step 1) or remember to refer here when you need it.

When finished, you’ll be ready to install your next peripheral. If you have installed all of your peripherals, refer to the *User’s Guide* that came with your operating/language system.

---

# BASIC System Worksheet Entry

---

## NOTE

With revision 5.0 and later, you need not set switch 4 to keyboard, nor do you need to set switches 9 and 10 to select **Return**. In this case, use the ON HIL EXT statement and the HILBUF\$ function to read the bar code.

---

## CAUTION

New devices added to the HP-HIL interface while the BASIC system is running will not be recognized until a SCRATCH A command is executed. Also, data received from the HP-HIL interface may be garbled if the order of devices is changed while the system is running.

---

Device Name	Device Selector	Digitizer Specifier	Power Req.
HP 92916A	—	—	133 mA

---

## Pascal Workstation Worksheet Entry

---

### CAUTION

Connecting or disconnecting HP-HIL devices while the Pascal Workstation is running may hang the system. The *only* times when you may safely connect or disconnect an HP-HIL device is when the system's power is off, or while the system's command line is being displayed *and* the time/date display (from the Version command) is not being displayed.

---

Device Name	Device Selector	Module Name	Power Req.
HP 92916A	—	—	133 mA

---

## HP-UX System Worksheet Entries

---

### NOTE

HP-HIL devices can be added to or removed from the HP-HIL interface without affecting the HP-UX operating system. However, if your application requires the use of a particular device and you remove the device from the link, open the link to the device, or open the link to add a new device, your application might not recognize the change and may not work as expected.

---

Device Name	Path Name	File Type	Major No.	Minor No. <sup>1</sup>	Power Req.
HP 92916A	/dev/r8042	c	23	0x000000	133 mA
HP 92916A	/dev/wand	c	24	0x000020	133 mA

---

<sup>1</sup> The second minor number in the table assumes the bar code reader is the second device on the HP-HIL interface (address=2). If this is not the case, substitute the correct position (address) of the bar code reader in place of the 2 in the minor number (e.g., if the bar code reader is the third device on the interface, the minor number would be 0x000030).

---

# Installing the HP 9884A Paper Tape Punch

## Description

The HP 9884A Paper Tape Punch punches paper mylar or plastic tape at speeds up to 75 characters/second. It connects to your computer via the HP 98622A GPIO Interface.

## Support

The HP 9884A Paper Tape Punch is supported on Series 200 Model 217, 220, 226, 236 and 237 computers.

Operating/Language system support is as follows:

- **BASIC:** not supported.
- **Pascal Workstation:** supported on revision 3.0 or later with Series 200 computers. Requires user-written software or the HP EGS/200 98310A Photoplotter/NC Drill utility.
- **HP-UX Operating System:** not supported.

## Before You Begin

The following procedure describes how to connect the Paper Tape Punch to your computer. Before you do this, however, refer to the manual that came with the modem to:

- Unpack the paper tape punch.

## Paper Tape Punch Installation Procedure

1. **Play It Safe.**
  - a. Turn your computer and paper tape punch off, if they are not already off.
2. **Connect the Paper Tape Punch to Your Computer.**
  - a. Connect the paper tape punch cable (HP 5060-1854) to the socket on the rear of the paper tape punch.
  - b. Connect the other end of the cable to the GPIO Interface.
3. **Connect the Power Cord.**
  - a. Insert the power cord into the power connector on the back of the paper tape punch, and plug the other end into your power outlet.

---

## The Next Step

You have now installed your paper tape punch.

The following “Worksheet Entry” contains information needed to use your paper tape punch with the Pascal Workstation.

Copy this information to a worksheet (worksheets are found at the end of Step 1) or remember to refer here when you need it.

When finished, you’ll be ready to install your next peripheral. If you have installed all of your peripherals, refer to the *User’s Guide* that came with your operating/language system.

---

## Pascal Workstation Worksheet Entry

Device Name	Device Selector <sup>1</sup>
HP 9884A	12

<sup>1</sup> If you connected your paper tape punch to a GPIO interface with a select code other than 12, write in your select code instead of 12.

---

# Installing the HP 46030A Vectra Keyboard

## Description

The HP 46030A Vectra Keyboard, when used with BASIC, provides user-definable buttons for menu selection, and three user-programmable LEDs. It cannot be used as an ordinary keyboard. Buttons can be labeled with defined functions, freeing the display for other uses. It connects to your computer via the HP-HIL interface.

## Support

The HP 46030A Vectra Keyboard is supported on Series 300 computers that have the correct version of the keyboard controller. Contact your HP sales representative for more information.

Operating/Language systems support is as follows:

- **BASIC:** supported on revision 5.0 or later.
- **Pascal Workstation:** not supported.
- **HP-UX Operating System:** not supported.

## HP 46030A Vectra Keyboard Installation Procedure

---

### NOTE

Connecting and disconnecting HP-HIL devices while some language/operating systems or application programs are running may lead to unpredictable results. When possible, connect all needed HP-HIL devices to your computer before booting a language/operating system or running an application program.

---

1. Find the HP-HIL cable that came with the Vectra Keyboard.
2. Find the end of the cable that is marked with one black dot.
3. Find the HP-HIL connector on the Vectra Keyboard that is marked with one dot.

4. Plug the “one-dot” end of the cable into the “one-dot” connector on the Vectra Keyboard.
  5. Connect the other, “two-dot” end of the cable into the HP-HIL connector on your computer (marked “KYBD” or “KEYBOARD”), or to the “two-dot” connector of the last HP-HIL device you installed (e.g., your standard keyboard).
  6. Keep these constraints in mind:
    - You cannot have more than 7 HP-HIL addressable devices connected to your computer at one time. The HP 46080A, 46081A, 46082A and 46082B Extension modules and the HP 46089A Four-Button Cursor do not count as addressable devices, and the HP 46085A Control Dials Module counts as *three* addressable devices. All other devices count as one addressable device.
    - The current requirements of all of your devices must not exceed 750 milliamps (mA). To make sure you do not exceed this requirement, total up the typical power required by each of your HP-HIL devices as given in the following “Worksheet Entries” sections. If the total exceeds 750 mA, you must remove one or more devices.
- 

## The Next Step

You have now installed your HP 46030A Vectra Keyboard.

The following “Worksheet Entry” contain information needed to use your Vectra Keyboard with BASIC.

Copy this information to a worksheet (worksheets are found at the end of Step 1) or remember to refer here when you need it.

When finished, you’ll be ready to install your next peripheral. If you have installed all of your peripherals, refer to the *User’s Guide* that came with your BASIC language system.

---

## BASIC System Worksheet Entries

---

### NOTE

To use the Vectra Keyboard, use the ON HIL EXT statement, the HILBUF\$ function, and the HIL SEND statement.

---

### CAUTION

New devices added to the HP-HIL interface while the BASIC system is running will not be recognized until a SCRATCH A command is executed. Also, data received from the HP-HIL interface may be garbled if the order of devices is changed while the system is running.

---

Device Name	Device Selector	Digitizer Specifier	Power Req.
HP 46030A	—	—	67 mA



---

# Installing the HP 45911A Graphics Tablet

## Description

The HP 45911A is an 11×11-inch graphics tablet suitable for menu/object picking, free-hand graphics entry and digitizing. The tablet includes a stylus with tip switch and a platen overlay. It connects to your computer via the HP-HIL interface.

## Support

The HP 45911A is supported on all Series 300 computers. Support for Series 200 Model 220 and 237 computers was under investigation at time of printing.

Operating/Language systems support is as follows:

- **BASIC:** supported on revision 4.0 or later with both Series 200 and Series 300 computers.
- **Pascal Workstation:** supported on revision 3.1 or later with both Series 200 and Series 300 computers.
- **HP-UX Operating System:** supported on revision 5.1 or later with Series 300 computers only.

## HP 45911A Graphics Tablet Installation Procedure

---

### NOTE

Connecting and disconnecting HP-HIL devices while some language/operating systems or application programs are running may lead to unpredictable results. When possible, connect all needed HP-HIL devices to your computer before booting a language/operating system or running an application program.

---

1. Find the HP-HIL cable that came with the tablet.
2. Find the end of the cable that is marked with one black dot.
3. Find the HP-HIL connector on the tablet that is marked with one dot.
4. Plug the “one-dot” end of the cable into the “one-dot” connector on the tablet.
5. Connect the other, “two-dot” end of the cable into the HP-HIL connector on your computer (marked “KYBD” or “KEYBOARD”), or to the “two-dot” connector of the last HP-HIL device you installed (e.g. keyboard).
6. Plug the stylus into the telephone jack on the tablet.
7. Keep these constraints in mind:
  - You cannot have more than 7 HP-HIL addressable devices connected to your computer at one time. The HP 46080A, 46081A, 46082A and 46082B Extension modules and the HP 46089A Four-Button Cursor do not count as addressable devices, and the HP 46085A Control Dials Module counts as *three* addressable devices. All other devices count as one addressable device.
  - The current requirements of all of your devices must not exceed 750 milliamps (mA). To make sure you do not exceed this requirement, total up the typical power required by each of your HP-HIL devices as given in the following “Worksheet Entries” sections. If the total exceeds 750 mA, you must remove one or more devices.

---

## The Next Step

You have now installed your HP 45911A Graphics Tablet.

The following “Worksheet Entries” contain information needed to use your tablet with various language/operating systems. Refer to the entries for the system you’ll be using (BASIC, Pascal or HP-UX).

Copy this information to a worksheet (worksheets are found at the end of Step 1) or remember to refer here when you need it.

When finished, you’ll be ready to install your next peripheral. If you have installed all of your peripherals, refer to the *User’s Guide* that came with your operating/language system.

---

## BASIC System Worksheet Entry

---

### NOTE

Digitizing over the entire tablet surface is possible. However, due to the tablet’s square aspect ratio, cursor tracking is not possible over the top 25% of the tablet.

---

---

### CAUTION

New devices added to the HP-HIL interface while the BASIC system is running will not be recognized until a SCRATCH A command is executed. Also, data received from the HP-HIL interface may be garbled if the order of devices is changed while the system is running.

---

Device Name	Device Selector	Digitizer Specifier	Power Req.
HP 45911A	KBD	“TABLET”	133 mA

---

## Pascal Workstation Worksheet Entry

---

### CAUTION

Connecting or disconnecting HP-HIL devices while the Pascal Workstation is running may hang the system. The *only* times when you may safely connect or disconnect an HP-HIL device is when the system's power is off, or while the system's command line is being displayed *and* the time/date display (from the Version command) is not being displayed.

---

Device Name	Device Selector	Module Name	Power Req.
HP 45911A	201	HPHIL & DGL_ABS	133 mA

---

## HP-UX System Worksheet Entries

---

### NOTE

HP-HIL devices can be added to or removed from the HP-HIL interface without affecting the HP-UX operating system. However, if your application requires the use of a particular device and you remove the device from the link, open the link to the device, or open the link to add a new device, your application might not recognize the change and may not work as expected.

---

Device Name	Path Name	File Type	Major No.	Minor No. <sup>1</sup>	Power Req.
HP 45911A	/dev/r8042	c	23	0x000000	133 mA
HP 45911A	/dev/digitizer	c	24	0x000020	133 mA

---

<sup>1</sup> The second minor number in the table assumes the graphics tablet is the second device on the HP-HIL interface (address=2). If this is not the case, substitute the correct position (address) of the tablet in place of the **2** in the minor number (e.g., if the tablet is the third device on the interface, the minor number would be 0x000030).

---

# Installing the HP 98203C Keyboard

## Description

The HP 98203C Keyboard connects to your computer via the HP-HIL interface.

## Support

The HP 98203C Keyboard is supported on all Series 300 computers except the Model 318.

Operating/Language systems support is as follows:

- **BASIC:** supported on revision 4.03 or later.
- **Pascal Workstation:** supported on revision 3.12 or later.
- **HP-UX Operating System:** not supported.

## HP 98203C Keyboard Installation Procedure

---

### NOTE

Connecting and disconnecting HP-HIL devices while some language/operating systems or application programs are running may lead to unpredictable results. When possible, connect all needed HP-HIL devices to your computer before booting a language/operating system or running an application program.

---

1. Find the HP-HIL cable that came with your computer.
2. Find the end of the cable that is marked with one black dot.
3. Find the connector on the back of the keyboard that is marked with one dot.
4. Plug the “one-dot” end of the cable into the “one-dot” connector on the keyboard.
5. Connect the other, “two-dot” end of the cable into the HP-HIL connector on your computer (marked “KYBD” or “KEYBOARD”), or to the “two-dot” connector of the last HP-HIL device you installed.

6. Keep these constraints in mind:

- You cannot have more than 7 HP-HIL addressable devices connected to your computer at one time. The HP 46080A, 46081A, 46082A and 46082B Extension modules and the HP 46089A Four-Button Cursor do not count as addressable devices, and the HP 46085A Control Dials Module counts as *three* addressable devices. All other devices count as one addressable device.
- The current requirements of all of your devices must not exceed 750 milliamps (mA). To make sure you do not exceed this requirement, total up the typical power required by each of your HP-HIL devices as given in the following “Worksheet Entries” sections. If the total exceeds 750 mA, you must remove one or more devices.

---

## The Next Step

You have now installed your HP 98203C Keyboard.

The following “Worksheet Entries” contain information needed to use your keyboard with various language/operating systems. Refer to the entries for the system you’ll be using (BASIC or Pascal).

Copy this information to a worksheet (worksheets are found at the end of Step 1) or remember to refer here when you need it.

When finished, you’ll be ready to install your next peripheral. If you have installed all of your peripherals, refer to the *User’s Guide* that came with your operating/language system.

---

## BASIC System Worksheet Entry

---

### NOTE

To use the keyboard's knob, you must load the KBD binary.

---

---

### CAUTION

New devices added to the HP-HIL interface while the BASIC system is running will not be recognized until a SCRATCH A command is executed. Also, data received from the HP-HIL interface may be garbled if the order of devices is changed while the system is running.

---

Device Name	Device Selector	Digitizer Specifier	Power Req.
HP 98203C	KBD	"KBD"	67 mA

---

## Pascal Workstation Worksheet Entry

---

### CAUTION

Connecting or disconnecting HP-HIL devices while the Pascal Workstation is running may hang the system. The *only* times when you may safely connect or disconnect an HP-HIL device is when the system's power is off, or while the system's command line is being displayed *and* the time/date display (from the Version command) is not being displayed.

---

Device Name	Device Selector	Module Name	Power Req.
HP 98203C	2		67 mA







**HP Part Number**  
**97005-90000**

Microfiche No. 97005-99000  
Printed in U.S.A. 9/87



**97005-90617**  
For Internal Use Only