

**HP 9000 Series 200 Computers  
Model 226/236**

**Installation Guide**

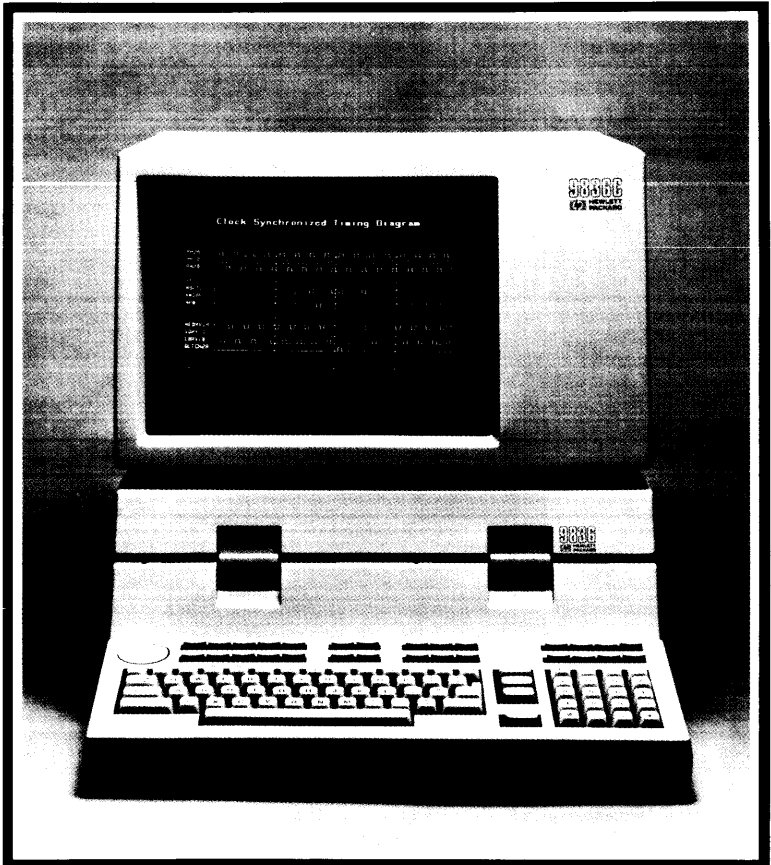

# **Installation Guide**

*for the HP 9000 Series 200  
Model 226/236 Computers*

Manual Part No. 09836-90001

© Copyright 1984, 1985, Hewlett-Packard Company.

This document contains proprietary information which is protected by copyright. All rights are reserved. No part of this document may be photocopied, reproduced or translated to another language without the prior written consent of Hewlett-Packard Company. The information contained in this document is subject to change without notice.

Use of this manual and flexible disc(s) or tape cartridge(s) supplied for this pack is restricted to this product only. Additional copies of the programs can be made for security and back-up purposes only. Resale of the programs in their present form or with alterations, is expressly prohibited.

#### Restricted Rights Legend

Use, duplication, or disclosure by the Government is subject to restrictions as set forth in paragraph (b)(3)(B) of the Rights in Technical Data and Software clause in DAR 7-104.9(a).

© Copyright 1980, Bell Telephone Laboratories, Inc.

© Copyright 1979, 1980, The Regents of the University of California.

This software and documentation is based in part on the Fourth Berkeley Software Distribution under license from the Regents of the University of California.



**Hewlett-Packard Company**  
3404 East Harmony Road, Fort Collins, Colorado 80525

# Printing History

New editions of this manual will incorporate all material updated since the previous edition. Update packages may be issued between editions and contain replacement and additional pages to be merged into the manual by the user. Each updated page will be indicated by a revision date at the bottom of the page. A vertical bar in the margin indicates the changes on each page. Note that pages which are rearranged due to changes on a previous page are not considered revised.

The manual printing date and part number indicate its current edition. The printing date changes when a new edition is printed. (Minor corrections and updates which are incorporated at reprint do not cause the date to change.) The manual part number changes when extensive technical changes are incorporated.

April 1984...First Edition

December 1984...Update: Updated pages ii-vi, 8-10, 15-18, 21-27, 38, 55, 57, 65, 66

January 1985...First Edition Update merged.

## Warranty Statement

Hewlett-Packard products are warranted against defects in materials and workmanship. For Hewlett-Packard computer system products sold in the U.S.A. and Canada, this warranty applies for ninety (90) days from the date of shipment.\* Hewlett-Packard will, at its option, repair or replace equipment which proves to be defective during the warranty period. This warranty includes labor, parts, and surface travel costs, if any. Equipment returned to Hewlett-Packard for repair must be shipped freight prepaid. Repairs necessitated by misuse of the equipment, or by hardware, software, or interfacing not provided by Hewlett-Packard are not covered by this warranty.

HP warrants that its software and firmware designated by HP for use with a CPU will execute its programming instructions when properly installed on that CPU. HP does not warrant that the operation of the CPU, software, or firmware will be uninterrupted or error free.

NO OTHER WARRANTY IS EXPRESSED OR IMPLIED, INCLUDING BUT NOT LIMITED TO, THE IMPLIED WARRANTY OF MERCHANTABILITY AND FITNESS FOR A PARTICULAR PURPOSE. HEWLETT-PACKARD SHALL NOT BE LIABLE FOR CONSEQUENTIAL DAMAGES.

### HP 9000 Series 200

For the HP 9000 Series 200 family, the following special requirements apply. The Model 216 computer comes with a 90-day, Return-to-HP warranty during which time HP will repair your Model 216, however, the computer must be shipped to an HP Repair Center.

All other Series 200 computers come with a 90-Day On-Site warranty during which time HP will travel to your site and repair any defects. The following minimum configuration of equipment is necessary to run the appropriate HP diagnostic programs: 1) 1/2 Mbyte RAM; 2) HP-compatible 3 1/2" or 5 1/4" disc drive for loading system functional tests, or a system install device for HP-UX installations; 3) system console consisting of a keyboard and video display to allow interaction with the CPU and to report the results of the diagnostics.

To order or to obtain additional information on HP support services and service contracts, call the HP Support Services Telemarketing Center at (800) 835-4747 or your local HP Sales and Support office.

\* For other countries, contact your local Sales and Support Office to determine warranty terms.

# Table of Contents

## Chapter 1 - Introduction

Banish Your Fears .....	1
How This Guide Is Organized .....	2
Computer Fundamentals .....	3

## Chapter 2 - Installing Your Computer

1. Position Your Computer .....	8
2. Install the Display (Model 236) .....	9
3. Check The Line-Voltage Switches .....	10
4. Check The Fuses .....	11
5. Remove The Disc Drive Shipping Inserts .....	11
6. Connect The Power Cord(s) .....	12
7. Turn On Your Computer .....	13
8. Adjust The Brightness .....	13

## Chapter 3 - Installing Backplane Accessories

How This Chapter Is Organized .....	16
Backplane Accessories .....	16.1
Backplane Power Limits .....	16.2
Memory Concepts .....	18
Memory Terms .....	18
Setting the Switches .....	18
Interfacing Concepts .....	19
Built-in Interface .....	19
The Select Code .....	20
1. Assign Accessories to Slots .....	21
2. Configure and Install Non-Interface Accessories .....	23
3. Configure And Install Your Interfaces .....	24.6

## Chapter 4 - Installing HP-IB Peripherals

HP-IB Peripheral Devices .....	27
Disc Drives .....	27
Tape Drives .....	27
Printers .....	28
Graphics Devices .....	28
Instruments .....	28
What is the HP-IB? .....	29
How the Bus Works .....	30
The Controller .....	30
The Talkers .....	32

- The Listeners . . . . . 32
- Bus Addresses . . . . . 32
- Setting Up and Connecting Your HP-IB Peripherals . . . . . 33

**Chapter 5 - Installing Non-HP-IB Peripherals**

- Non-HP-IB Peripheral Devices . . . . . 37
- Data Communications (Datacomm) . . . . . 38
  - What is the Data Communications Interface? . . . . . 38
  - Data Communications Concepts . . . . . 39
  - Cable Connections . . . . . 42
  - Terminal Emulation . . . . . 45

**Chapter 6 - Reading the Self-Test**

- Self-Test Messages . . . . . 47
  - Status Messages . . . . . 48
  - Error Messages . . . . . 48
  - Boot ROM Beeper . . . . . 49
  - Boot ROM Errors . . . . . 50
- Running an Extended Memory Test . . . . . 50
- What to Do When Errors Occur . . . . . 51
- Where to Get Help . . . . . 51
- Boot ROM 3.0 and 4.0 Error Messages . . . . . 52
- Early Boot ROM Error Messages . . . . . 53

**Chapter 7 - Setting Up for HP-UX**

- Installing Your Computer . . . . . 56
- Installing Backplane Accessories . . . . . 56
  - Memory Requirements . . . . . 56
  - DMA Controller . . . . . 56
  - HP 98625A High-speed Disc Interface . . . . . 56
  - HP 98624A HP-IB Interface(s) . . . . . 57
  - HP 98626A Asynchronous Serial Interface . . . . . 58
  - HP 98628A Datacomm Interface . . . . . 58
- Installing HP-IB Peripherals . . . . . 61
- Installing Non-HP-IB Peripherals . . . . . 63
  - Datacomm Cables . . . . . 63
  - Connecting Terminals . . . . . 64
  - Terminal Baud Rate Settings . . . . . 66
  - Terminal Configuration . . . . . 67

**Appendix A - Sales and Service**

- Peripherals and Accessories . . . . . 69
- Service Information . . . . . 70

## List of Figures

Installation Highlights . . . . .	6
Position the Computer to Allow Free Air Flow . . . . .	8
Connecting Display Cable to Mainframe . . . . .	9
Connecting Display Cable to Model 236 Color Display . . . . .	9
Setting the Line-Voltage Switches . . . . .	10
Available Power Cords . . . . .	12
Typical Model 236 Power-up Display . . . . .	13
Selecting an Interface . . . . .	20
Removing the Accessory Card Cage Covers . . . . .	21
Accessory Card Cage . . . . .	21
Memory Cards Installed . . . . .	23
HP 98256 Memory Address Configuration Switches . . . . .	24
HP 98257A Memory Address Configuration Switches . . . . .	24.1
Communication on the HP-IB . . . . .	30
Inserting a Memory Card . . . . .	24.4
Seating a Memory Card . . . . .	24.4
Correctly and Incorrectly Installed RAM Cards . . . . .	24.5
Internal HP-IB Configuration Jumper . . . . .	31
Available HP-IB Cables . . . . .	34
Parallel Transmission . . . . .	39
Serial Transmission . . . . .	40
Indistinguishable Characters . . . . .	40
Distinguishable Character . . . . .	41
Transmission Rate Problem . . . . .	41
DTE Cable with Male Connector . . . . .	43
DCE Cable with Female Connector . . . . .	43
Connecting Your Computer to a Modem . . . . .	43
Connecting Your Computer to Another Computer . . . . .	44
Connecting Your Computer to a DCE Peripheral . . . . .	44
Connecting Your Computer to a DTE Peripheral . . . . .	45
Configuring the HP 98625A High-speed Disc Interface for HP-UX . . . . .	56
Configuring the HP 98624A HP-IB Interface for HP-UX . . . . .	57
HP 98626A Asynchronous Serial Interface Switches . . . . .	59
HP 98628A Datacomm Interface Switches . . . . .	60
Example of a Modem-connected Terminal . . . . .	66

## List of Tables

Memory Card Switch Settings . . . . .	24.2
HP-UX Select Codes . . . . .	58
HP-IB Bus Address Assignments for HP-UX . . . . .	62
Terminal Configuration Settings . . . . .	67
Datacomm Configuration Settings . . . . .	68

**FEDERAL COMMUNICATIONS COMMISSION  
RADIO FREQUENCY INTERFERENCE  
STATEMENT (U.S.A. ONLY)**

The Federal Communications Commission (in Subpart J of Part 15, Docket 20780) has specified that the following notice be brought to the attention of the users of this product.

**Warning:** The Model 236 (with color) Computer generates, uses, and can radiate radio frequency energy and if not installed and used in accordance with the instructions manual, may cause interference to radio communications. It has been tested and found to comply with the limits for a Class A computing device pursuant to Subpart J of Part 15 of FCC Rules, which are designed to provide reasonable protection against such interference when operated in a commercial environment. Operation of this equipment in a residential area is likely to cause interference in which case the user at his own expense will be required to take whatever measures may be required to correct the interference.

The Models 226 and 236 (without color) Computers generate and use radio frequency energy and if not installed and used properly, that is, in strict accordance with the manufacturer's instructions, may cause interference to radio and television reception. It has been type tested and found to comply with the limits for a Class B computing device in accordance with the specifications in Subpart J of Part 15 of FCC Rules, which are designed to provide reasonable protection against such interference in a residential installation. However, there is no guarantee that interference will not occur in a particular installation. If this equipment does cause interference to radio or television reception, which can be determined by turning the equipment off and on, the user is encouraged to try to correct the interference by one or more of the following measures:

- reorient the receiving antenna
- relocate the computer with respect to the receiver
- move the computer away from the receiver
- plug the computer into a different outlet so that computer and receiver are on different branch circuits.

If necessary, the user should consult the dealer or an experienced radio/television technician for additional suggestions. The user may find the following booklet prepared by the Federal Communications Commission helpful:

*How to Identify and Resolve Radio-TV Interference Problems*

This booklet is available from the U.S. Government Printing Office, Washington, D.C. 20402, Stock No. 004-000-00345-4.

# Introduction

Chapter

1

## Banish Your Fears

Your new computer has just arrived. You're looking for some easy instructions to get it set up and running, and you've turned to this guide for help. You've come to the right place.

Before you proceed, we want to address a few preconceptions you may have about computer documentation. Yes, we know that you may be less than enthusiastic about reading this guide. You're concerned that you'll have to read for hours before you can finally put the book down and actually *do something* with your computer. Or perhaps you're afraid that we'll presume you have a Ph.D. in electrical engineering, give you a schematic of the computer, and tell you to figure it out for yourself.

Forget it. That's not going to happen here. This guide tells you how to put your computer system together and turn it on. When you're done with this manual, you'll be ready to load and use your operating system or applications program.



## How This Guide Is Organized

This guide has seven chapters. Read the first six in order, performing the installation procedures as you go. You will use Chapter 7 only if you have an HP-UX computer.

**Chapter 1 – Introduction.** You're now reading Chapter 1. This section tells you how your installation guide is organized. The last section of this chapter is called "Computer Fundamentals". If you are unfamiliar with computer technology and terminology, read this.

**Chapter 2 – Installing Your Computer.** This chapter tells you how to install the computer.

**Chapter 3 – Installing Backplane Accessories.** This chapter tells you how to set the switches on your additional memory cards, interface cards, and other backplane cards, and how to install them in your computer.

**Chapter 4 – Installing HP-IB Peripherals.** This chapter tells you how to set up your HP-IB peripheral devices and connect them to your computer.

**Chapter 5 – Installing Non-HP-IB Peripherals.** This chapter tells you how to set up and install data communications equipment and other non-HP-IB peripherals.

**Chapter 6 – Reading The Self-Test.** This chapter tells you how to turn on your computer system and read and interpret the self-test messages.

**Chapter 7 – Setting Up For HP-UX.** If you will not use the HP-UX operating system, ignore this chapter. It contains hardware installation requirements that are specific to HP-UX. You will be referred to this chapter from other chapters when you need to set up for HP-UX.

## Computer Fundamentals

If you think computer technology is intimidating and unknowable, and if all of that computer jargon sounds like pure gobbledygook to you, read on—this section is for you. In just a few minutes you'll be able to talk computers with the best of them.

The next few paragraphs will put your computer into a more human perspective. We will argue that computers have the same basic design as people, except that they have much lower I.Q.s and don't complain as much about doing repetitive, mundane tasks. We'll start at the center of your computer and work our way out.

The **processor** is the command center of the computer, just as the brain is the command center of a human being. This tiny chip contains thousands of circuits, like the nerve fibers of the brain. Each circuit performs at near light speeds one of the operations that the computer is designed to do.

Just because the processor runs close to the speed of light and is capable of many great operations, don't assume it's intelligent. The processor is a very docile creature; it never had an original thought in its life. It does exactly as it's told, and if it's told nothing, it does nothing. In order to make the processor do something worthwhile, you must give it a set of instructions called a **program**. It's the program (also called **software**) that makes the processor perform complicated calculations, plot graphics and do all of the other marvelous things that we associate with computers.

People have programs too, of course. When someone gives another person directions for getting to his house, he's giving that person a sort of "program". Of course, if this person forgets the directions, he's not going to get very far. The same is true for computers. Fortunately, both computers and people have a **memory** that they can store their programs in.

There are two types of computer memory: **Random Access Memory** or **RAM**, and **Read-Only Memory** or **ROM** (computer designers love to make acronyms of everything, but you'll get used to it).

RAM is similar to a human being's short-term memory. You can commit a program to memory, remember it a short time later when you need it, and then erase (forget) it when you're through. When the computer's power is turned off, everything stored in RAM is erased.

ROM is a different story, akin to a person's long-term memory. This is where the computer stores the experiences that it can't afford to forget, not even when the power is turned off. Once something is committed to ROM at the factory, it can be recalled but never erased. Since ROM is not re-programmable like RAM, it's more expensive and is used for only the most essential programs.

One of these essential programs is the set of instructions that wake the computer up when its power is turned on. When a human being gets up in the morning, he has a set of automatic responses that tell him how to open his eyes, get out of bed, take a shower and eat breakfast. In your computer, the equivalent instructions are called the **booting program** and they are stored in a special place called the **Boot ROM**. Note that because RAM is erased when the power is turned off, the booting program must be stored in ROM.

So now the computer can function. It has a memory to store programs and data and it has a processor to execute the programs and process the data. But how can the computer communicate with us mortals, who are waiting anxiously for the results? Right now it can't, so **peripheral devices** must be added.

Peripheral devices (or **peripherals**, for short) are the computer's communication link to the outside world, much as a person's ears and mouth are his communication devices. There are two main classes of peripherals, although some devices fall into both classes. **Input devices** accept information from the outside world and give it to the processor. In humans, input devices include ears and eyes; in computers, they include keyboards and **disc drives**. **Output devices** accept information from the processor and give it to the outside world. A person's vocal chords are an output device, as are a video screen (also called a CRT), disc drive, and printer.

The **disc drive** is a very important peripheral device and is worth a closer look. One problem computers face is how to get programs into memory where the processor can get to them. One way is to type a program in line-by-line at the keyboard everytime someone wants to run it, but that would be tedious. Or all programs could be stored in ROM, but that would be expensive. Clearly, the best way is to store programs on some kind of inexpensive media, and then design a device to transfer the programs from the media into memory. The media most often used today is the disc, and the device that drives the disc is, naturally, the disc drive.

The disc drive is very much like a record player, except that it records data and programs instead of music. The disc drive rotates the disc, and waits for the processor to ask for a program. When the request comes through, the disc drive finds the desired program on the disc and copies it into memory.

One last problem: What happens when a person's ears send him messages in Greek and his brain does all his thinking in Hebrew? The usual solution is to hire an interpreter to moderate the conversation, one who speaks both Greek and Hebrew.

Surprisingly, this situation occurs in computers also. When a peripheral device is designed to communicate differently from the processor it's connected to, an **interface** is used to do the interpreting. The interface (interpreter) intercepts messages from the processor and translates them into the language the peripheral understands, and vice versa.

That's enough information to get you started. More specialized topics will be covered in the chapters to come. Now move on to Chapter 2.

① **Voltage Switch** - The computer is designed to run at either 90-125 Vac or 198-250 Vac. The line frequency range is 48-66 Hz.

② **Fuses** - You must have the correct fuses inserted for the computer to run.

③ **Power Socket** - The three-pronged power socket is especially designed for an HP power cord. The power cord(s) should be in the carton the computer came in.

④ **Power Switch** - This is the switch you should use to turn power ON and OFF. Never unplug or plug in the computer with the power switch turned ON.

⑤ **Brightness Knob** - On the Model 226 and Model 236 with color display, turning the brightness knob counter-clockwise increases the screen's brightness; turning it clockwise decreases the screen's brightness. On the Model 236 with monochrome display, turning the brightness knob clockwise increases the screen's brightness; turning it counter-clockwise decreases the brightness.

⑥ **The Fan** - The computer has a small built-in fan to keep the machine cool (the Model 236 with color display has an additional fan). The fan(s) should always be running when the computer is ON. If a fan ever goes OFF while the computer is powered on, switch the computer OFF and call your HP Service Representative.

⑦ **HP-IB Interface** - HP-IB stands for Hewlett-Packard Interface Bus. This interface is an industry standard for communicating with external instruments and devices (IEEE 488-1978). A single HP-IB can support up to 14 devices ranging from logic analyzers to printers and plotters. A switch allows you to specify whether or not your computer is a system controller. For information about how to access devices on the HP-IB, see the appropriate programming language or operating system manuals.

⑧ **Accessory Card Cage** - Remove these plates to install additional memory cards, interface cards, and other accessories. This is covered later in the chapter.

⑨ **Boot and Self-Test Messages** - The computer automatically tests parts of the system and loads (boots) an operating system at powerup. These topics are discussed in later chapters.

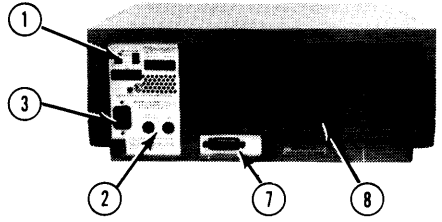
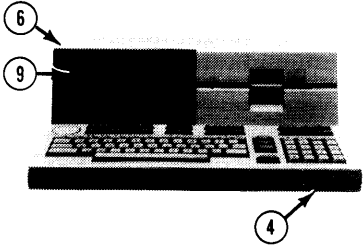

**The Model 226 Computer**

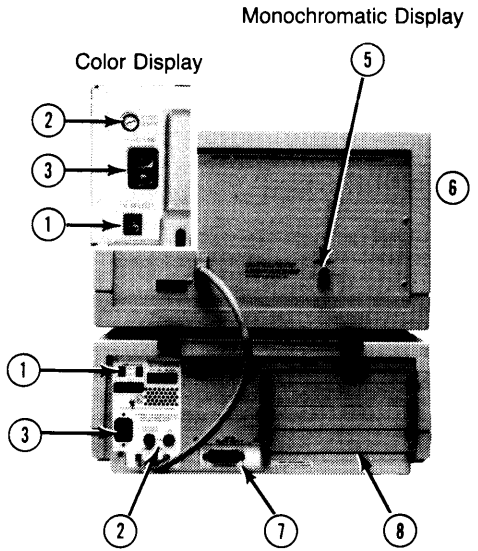
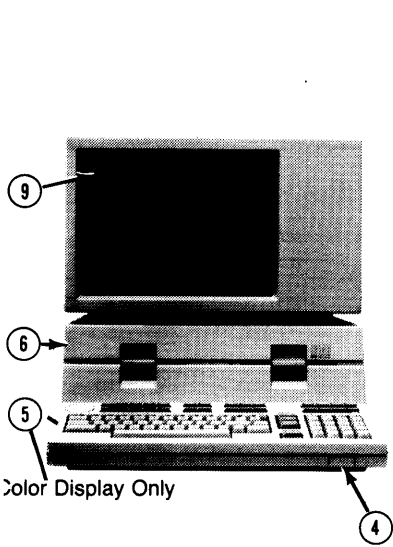

**The Model 236 Computer**

# Installing Your Computer

Chapter

2

---

**HP-UX Note!**

There are no HP-UX-specific installation procedures required in this chapter.

---

This chapter tells you how to:

- Position your computer.
- Install the display (Model 236).
- Check the line-voltage switches.
- Check the fuses.
- Remove the disc drive shipping inserts.
- Connect the power cord(s).
- Turn on your computer.
- Adjust the brightness.

Before you move on to the first procedure, pull out the photo fold-out at the beginning of this chapter and familiarize yourself with the computer parts. Find each part on your own computer as you look over the list. Leave the photos out so you can reference them when you begin the procedure.

## 1. Position Your Computer

Place your computer on any convenient surface. Be sure that there is at least 50 mm (2 inches) of space on all sides and top for ventilation. Do not operate the computer in areas with excessive dust or smoke.

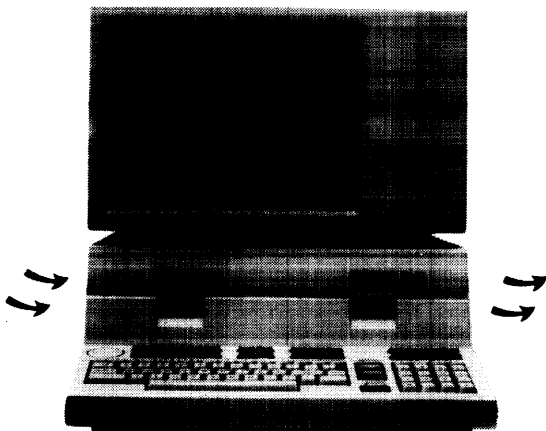

### Position the Computer to Allow Free Air Flow

Leave enough clearance at the back of the Model 236 for the display cable. If pressure is exerted against the computer-end of this cable, the connector could be damaged.

---

#### CAUTION

DO NOT LIFT OR MOVE THE MODEL 236 BY ITS DISPLAY. THE DISPLAY LOCKING TABS CANNOT CARRY THE WEIGHT OF THE COMPUTER. LIFT OR MOVE THE MODEL 236 BY ITS BASE ONLY.

---



## 2. Install the Display (Model 236)

Carefully set the display on the computer so that the display's feet rest in the four notches on the computer's top. Then slide the locking tabs out and back in to lock the display in place.

Attach the end of the interconnect cable (on the Model 236 with color display, it is the connector **with** the sliding lock clip) to the "D" connector on the rear of the display. Use a small flat blade screwdriver to tighten the two screws.

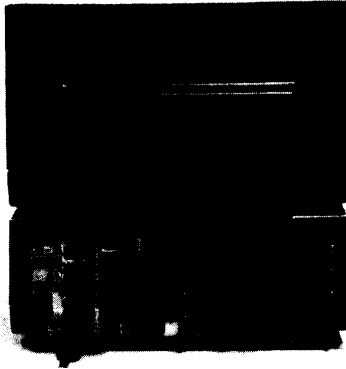

### Connecting Display Cable to Mainframe

On the Model 236 with color display, attach the end of the interconnect cable **without** the sliding lock clip to the "D" connector on the rear of the display. Use a small flat blade screwdriver to tighten the two screws.

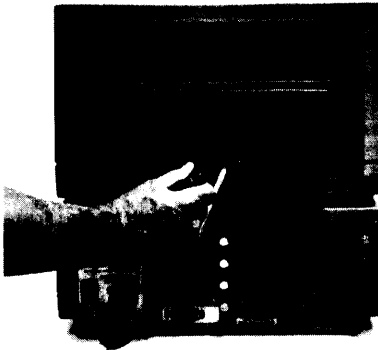

### Connecting Display Cable to Model 236 Color Display

### 3. Check the Line-Voltage Switches

Your computer can be set to operate at line voltages of 100, 120, 220, or 240 Vac. The switches on the back of the computer were set at the factory to the line voltage for your area. Check with your local utility for nominal line voltages. Then check your switches to make sure they are set correctly. The switches can be changed with a screwdriver or pen.

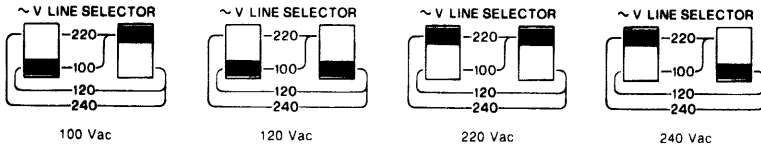

#### Setting the Line-Voltage Switches

---

##### CAUTION

THE COMPUTER CAN BE DAMAGED IF SET FOR 100 OR 120 VAC AND PLUGGED INTO A HIGHER VOLTAGE.

---

When installing a Model 236 computer with color display, be sure the display line switch matches the computer's nominal line setting, which will be either 115 Vac (for 100 and 120 Vac settings) or 230 Vac (for 220 and 240 Vac settings).

---

##### CAUTION

TO AVOID THE POSSIBILITY OF SERIOUS INJURY, DISCONNECT THE POWER CORD BEFORE REMOVING OR INSTALLING A FUSE.

---

## 4. Check the Fuses

---

**WARNING**

DO NOT CHECK OR CHANGE THE FUSE UNLESS POWER IS DISCONNECTED FROM THE COMPUTER.

---

The computer has two fuses on its back panel: one line fuse and one 15-amp fuse for the internal power supply. The Model 236 with color display has an additional line fuse on the display's back panel.

Be sure the correct line fuses are installed for the line voltage in your area. The required fuse ratings are labeled on the back panel. To remove the fuse holder, press in on it and turn it counterclockwise.

## 5. Remove the Disc Drive Shipping Inserts

Inserts are installed in the internal disc drives to protect the drives from shipping damage. Remove the shipping inserts from the drives.

## 6. Connect the Power Cord(s)

Ensure that the power switch is set to the off position (switch "out" or flush with the front of the computer).

Connect the mainframe power cord to the socket on the left-hand side of the fuses. Connect the other end of the power cord to your power outlet.

If you have a Model 236 with color display, connect the display power cord to the display socket. Connect the other end of the power cord to the outlet.

### WARNING

IF A REPLACEMENT POWER CORD IS NEEDED, MAKE SURE YOU ORDER AN HP POWER CORD THAT IS IDENTICAL TO THE ORIGINAL. OTHERWISE, ELECTRICAL SHOCK OR EQUIPMENT DAMAGE MAY RESULT.

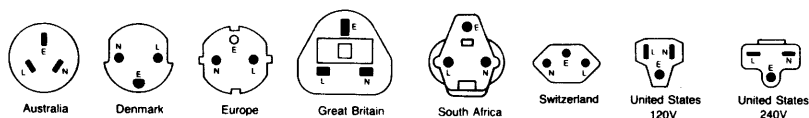

NOTE: Plugs are viewed from connector end. Shape of molded plug may vary within country.

Country	Part Number	Opt.	Voltage
Australia	8120-1369	901	250V, 6A
Denmark	8120-2956	912	250V, 6A
Europe	8120-1689	902	250V, 6A
Great Britain	8120-1351	900	250V, 6A
South Africa	8120-4211	917	250V, 10A
Switzerland	8120-2104	906	250V, 6A
United States	8120-1378	903	120V, 10A
United States	8120-0698	904	240V, 10A

Power cords supplied by HP have polarities matched to the power-input socket on the computer:

- L = Line or Active Conductor (also called "live" or "hot")
- N = Neutral or Identified Conductor
- E = Earth or Safety Ground

### Available Power Cords

## 7. Turn On Your Computer

Press in the switch at the right front of the computer. You should immediately hear the fan(s) running. It will take a moment for the screen to come on. When it does, you should see a display similar to the one shown in step 8.

## 8. Adjust the Brightness

If a display similar to the following does not appear on your screen, make sure the brightness knob is turned all the way up. If you have a Model 226 or Model 236 with color display, the brightness knob is on the lower left side of the computer. If you have a Model 236 with monochromatic display, the brightness knob is on the back of the display.

```

9836C
Copyright 1984,
Hewlett-Packard Company.
All Right Reserved.

BOOTROM 4.0
Keyboard
Color Graphics
2 Flexible Discs
HP-IB
655200 Bytes

BOOTING A SYSTEM
RESET To Power-Up
  
```

Device type  
↓  
: INTERNAL, 0 ← Unit Number  
1B System\_BA3  
↑                   ↑  
Operating       Filename  
System Code

**Typical Model 236 Power-up Display**

The list of components tells you that each has passed the computer's self-test. If you get a failure message, refer to Chapter 6 for further instructions. The bottom line tells you how much memory you have. In the preceding example, the computer has 256K bytes of internal RAM. If you have a 128K-byte model, the number will be closer to:

```
130912 Bytes
```

Model 226 or Model 236 computers built before May 1983 do not display the product number and serial number, nor do they have the built-in system tests shown above. These computers automatically run tests at powerup and display:

```
MEMORY TEST IN PROGRESS
```

Then the amount of available memory is shown:

```
xxxxxx AVAILABLE BYTES
UNABLE TO FIND SYSTEM
RESET TO RETRY
```

In either case, the computer ran some tests and tried to load an operating system. Since you didn't have a system disc in a drive, however, the computer couldn't find a system to load.

If any message but those shown above appears, your system may need service. Switch the computer off, wait a few seconds, and switch it on again. If the message is repeated, refer to the boot ROM error messages in Chapter 6.

So far, you haven't loaded an operating system or attached any peripheral devices. Operating systems can be loaded from hard or soft disc, from a cartridge tape, or from a ROM card plugged into the computer. As you add these elements to your system, the power-up display messages will change.

Before loading a system, however, let's continue with the installation process by configuring and adding backplane accessories to your computer.

# Installing Backplane Accessories

Chapter

**3**

Backplane accessories are devices that plug into your computer backplane. They include memory cards and interfaces. You must set switches on most accessories before you install them. This chapter tells you how to configure and install your backplane accessories. You will also find pointers to Chapter 7 for specific HP-UX configurations.

---

## CAUTION

MOST ACCESSORIES CONTAIN COMPONENTS THAT ARE SENSITIVE TO DAMAGE FROM ELECTROSTATIC DISCHARGE. WHENEVER YOU REMOVE, INSTALL, OR HANDLE ANY OF THESE DEVICES, BE SURE TO USE PROTECTIVE MEASURES INCLUDING ANTI-STATIC WORKSTATIONS AND PERSONNEL GROUNDING DEVICES. BE ESPECIALLY CAREFUL WHEN WORKING IN CARPETED AREAS.

---

## How this Chapter is Organized

This chapter is organized into six sections. The first three sections contain background information; the last three sections are required procedures and are numbered.

**List of Accessories** You may want to refer to this list for the part numbers and descriptions of the accessories available for your computer.

**Memory Concepts** If you are not familiar with computer memory, you should read this section. Otherwise, you may want to skim through this section or skip it entirely.

**Interfacing Concepts** Read this section if you want to get a good understanding of how your computer interfaces, or talks with, its peripheral devices.

**1. Assign Accessories to Slots** The first procedure is to decide where you will install your accessories.

**2. Configure and Install Non-Interface Accessories** Next, you will configure and install memory cards and other accessories that are not interfaces.

**3. Configure and Install Interfaces** Finally, you will set interface card switches and install the interfaces.



## Backplane Accessories

Your computer supports these accessories:

Power Requirements					
Product	Description	+5	+12	-12	Total
HP 9888A	Bus Expander	5.0			5.0
HP 98253A	EPROM Prog.	5.7			5.7
HP 98254A	64K byte RAM	3.0			3.0
HP 98255A	EPROM Card	2.8			2.8
HP 98256A	256K byte RAM	4.1			4.1
HP 98257A	1M byte RAM	6.0			6.0
HP 98259A	128K byte Bubble	2.4	2.9		5.3
HP 98601A	BASIC 2.0 ROM	2.4			2.4
HP 98604A	HPL 2.0 ROM	1.5			1.5
HP 98620A	DMA Controller	6.0			6.0
HP 98622A	GPIO Interface	3.8			3.8
HP 98623A	BCD Interface	2.5			2.5
HP 98624A	HP-IB Interface	2.4			2.4
HP 98625A	Disc Interface	3.0	0.1		3.1
HP 98626A	RS-232 Interface	2.0	0.6	0.6	3.2
HP 98627A	Color Interface	5.5			5.5
HP 98628A	Datacomm Interface	3.6	0.5	0.7	4.8
HP 98629A	Resource Mgmt. w/o 98028A	3.7	0.5	0.5	4.7
HP 98629A	Resource Mgmt. w/98028A	5.9	6.9	0.5	13.3
HP 98630A	Breadboard Card	1.3			1.3
HP 98633A	Multiprogrammer Int.	10.0			10.0
HP 98635A	Floating-Point Card	4.2			4.2
HP 98640A	A-D Card	2.6	0.7	0.2	3.5
HP 98644A	Serial Load Card	2.0	0.3	0.1	2.4
HP 98691A	Progr. Datacomm Inter.	6.4	2.0	1.3	9.7
HP 98695A	IBM 3270 Interface	7.2			7.2

## Backplane Power Limits

The limits for the backplane power available to accessories is not to be exceeded by the installed accessories. To help determine the power requirements of a particular set of accessories, the power requirements for each accessory are listed in the above table.

---

### CAUTION

IF THE POWER REQUIRED FOR ACCESSORIES EXCEEDS THE POWER AVAILABLE AT THE COMPUTER BACKPLANE, DAMAGE TO THE COMPUTER'S POWER SUPPLY AND/OR THE ACCESSORY WILL OCCUR. HEWLETT-PACKARD DOES NOT SUPPORT ACCESSORY CONFIGURATIONS REQUIRING MORE POWER THAN IS RECOMMENDED AT THE COMPUTER BACKPLANE.

---

To determine the suitability of a given set of accessories for your computer, follow these instructions:

1. Calculate the accessory power required for each supply voltage and the total power required for the accessory using the information in the above table. Enter these values in the "Total Power Required" block in the following table.
2. If the total power required is greater than 42 W, or the power drawn at any given voltage exceeds the value for that level, you must:
  - a. Change the type/number of accessories,
  - b. Add an HP 9888A Expander, or
3. Recalculate the power required versus power available.

Power Requirements Calculation Table

	Power Supply Voltage			Backplane Maximum
	+5	+12	-12	
accessory 1				
accessory 2				
accessory 3				
accessory 4				
accessory 5				
accessory 6				
accessory 7				
accessory 8				
Total power required				
HP 9826/9836 power available	38 W	11 W	7 W	42 W

## Memory Concepts

There are many ways to use your computer, and some applications require more random access memory (RAM) than others. Some programs can run by themselves; for them, the factory-installed memory may be sufficient. Others may require a BASIC (or other) language system in order to run; these programs require a larger memory. The size of your computer's memory can be increased by installing a plug-in RAM card in one of the eight accessory slots.

### Memory Terms

Before you install your RAM card, there are a few common terms associated with memory that you should be familiar with. You've probably heard these terms before, but since some of them have several interpretations, we define them now as they relate to your computer.

**Byte.** This is the unit of memory used on your computer. The byte is simply one location in memory, capable of storing one letter. The size of memory is expressed in bytes.

**K bytes.** Since the size of memory can be so large, often reaching several thousand bytes, the "K" convention was adopted to make memory sizes easier to express. "K" is nothing more than a multiplier with the value 1 024.

**M bytes.** Similarly, the “M” convention was adopted to make very large memory sizes easier to express. The “M” convention is nothing more than a multiplier with the value of 1024 K (or 1 048 576).

**Address.** Each byte in memory has a unique identifying number called an address. Whenever the processor wants to access a particular byte in memory, it uses the byte’s address to find it. If you think of memory as a large city with each byte representing one house, then any house (byte) in the city (memory) can be found by looking up its street (memory) address.

## Setting the Switches

When you install an HP 98256A RAM card in your computer, you increase the size of its RAM by 256K bytes. This is like adding a new subdivision of 262 144 houses to a city. When you build a new house in a city, you must assign it a street address. The same is true for a new byte of RAM; you must give it an address before the processor can recognize it. This is done with address switches.

Each 256K plug-in RAM card has a group of six switches that set the address of the first byte on the card. With the address of the first byte set, all other bytes on the card are assigned addresses automatically. Each RAM card must be set to a unique starting address using the six switches on the card.

The switches on plug-in RAM cards must be set so that there are no “addressing gaps” in the memory. The addresses of your computer’s built-in RAM are automatically updated each time a plug-in RAM card is added. Built-in memory addresses follow the addresses of the last plug-in RAM card.

If you follow the procedures for configuring memory which are given later in this chapter, you will have no problem with “addressing gaps”.

## Interfacing Concepts

HP makes several plug-in interfaces for your computer, making it possible to connect it to virtually any peripheral device. Up to four plug-in interfaces can be installed directly into your computer. To install more than four interfaces, you need an HP 9888A Backplane Expander.

The interface acts as an interpreter between your computer and a peripheral. Often the computer speaks one language and a peripheral device speaks another, so *direct* communication between the two is impossible. The interface's role is to mediate this conversation, translating messages from the computer's language into the peripheral's language and vice versa.

Interfaces allow computers to be more general purpose. Rather than wiring or programming a computer to speak every conceivable peripheral language, it's much easier (and less expensive) to simply plug in the specific interface card needed for the peripheral you want to connect. This approach can get cumbersome, though, if every peripheral you own requires a different interface.

### Built-in Interface

The situation described above, where each peripheral requires a different interface, is extremely rare. In fact, your computer's built-in HP-IB interface is usually sufficient for most applications.

The HP-IB interface allows you to connect most HP disc drives, printers, plotters and graphics tablets that are supported on your computer. And because you can connect up to 14 peripherals to a single HP-IB, this interface satisfies most peripheral interfacing needs. For more information on the HP-IB, refer to Chapter 4.

### The Select Code

Since every interface is different, there is no general set of installation instructions that applies to all of them. Refer to the installation instructions that came with your interface for details. However, there is one parameter which must be set on every interface you install. It's called the **select code**.

Suppose your computer contains two interfaces. Each interface is connected to one peripheral device, say a printer and a disc drive. The computer wants the printer to print something, so how does it select which interface (and thus which peripheral) it wants to send information to?

The answer is it selects the interface by specifying its select code. The select code is similar to a memory address, but instead of uniquely identifying a location in memory, it specifies an interface. Thus no two interfaces can have the same select code. One way to illustrate this idea is given below.

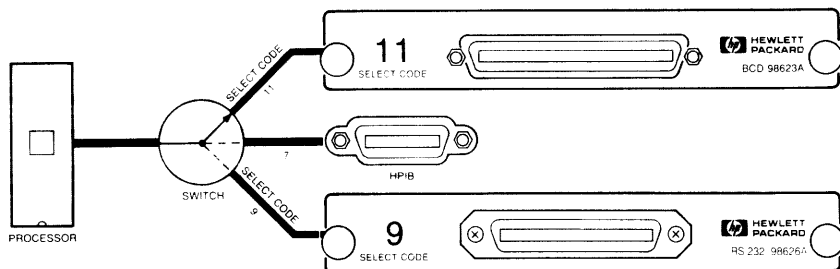

### Selecting an Interface

Think of the select code as a switching station through which all communication between the processor and the interfaces must pass. A single track leads from the processor to this switching station where it divides into several tracks, one to each interface in the computer.

When the processor wants to “talk” to a particular peripheral, it sets the switching station to the select code of the peripheral’s interface. Then information can only travel along the track that directly connects the processor with the desired device.

The select code of the built-in HP-IB interface is set to 7. The select codes of all plug-in interfaces are set with switches, similar to those used to address plug-in RAM cards. Each interface card is set at the factory to a unique select code. If this setting does not conflict with the select codes of your other interfaces, simply leave the switches as they are; otherwise change them to an unused value.

## 1. Assign Accessories to Slots

Turn the computer off. Remove the four accessory card cage covers at the back of the computer by turning the thumbscrews counterclockwise (see illustration).

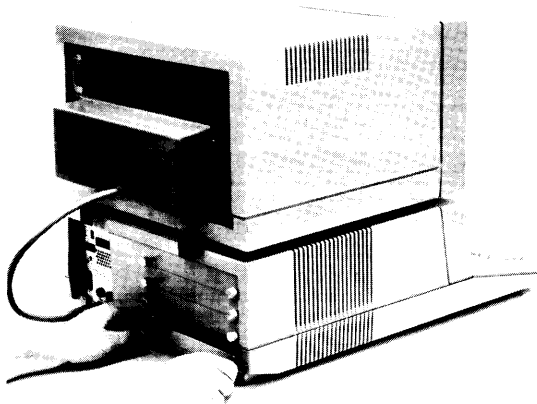

**Removing the Accessory Card Cage Covers**

Your computer has one 8-slot accessory card cage as shown in the following illustration. The built-in HP-IB interface is located beneath the accessory card cage opening.

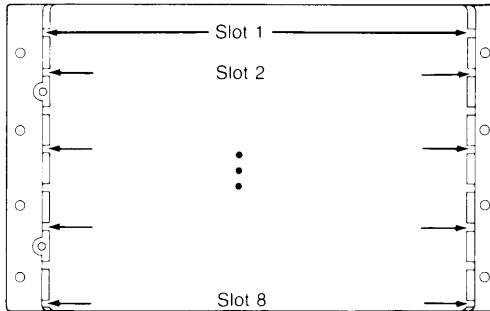

Interface with attached cover plates must be installed in these slots. All other accessories can be installed in any available slot.

### **Accessory Card Cage**

Assign interfaces to the slots below each pair of threaded thumbscrew holes in the rear panel (even-numbered slots in the illustration). Although each interface occupies only one slot, it must be an even-numbered slot so that the interface's attached cover plate mates correctly with the threaded holes.

Assign other accessories to the remaining slots. You may want to assign other accessories to the odd-numbered slots directly above the assigned interface slots first. That would group your accessories and limit the number of card cage covers to be removed.

---

#### Note

If you have more accessories than slots, you must use an HP 9888A Bus Expander which provides an additional 16 slots.

If you use an expander, ensure that the HP 98625A High-speed Disc Interface, the HP 98620A/B DMA Controller, and as many memory cards as possible are installed in the **computer's** accessory card cage.

---



## 2. Configure and Install Non-Interface Accessories

---

### HP-UX Note!

If you are going to run HP-UX on your computer, you need at least three HP 98256A 256K RAM Memory cards and an HP 98620B DMA Controller.

---

---

### CAUTION

SWITCH OFF THE COMPUTER BEFORE INSTALLING ANY MEMORY CARDS. PLUGGING OR UNPLUGGING A CARD WITH THE POWER ON CAN DAMAGE THE CARD AND THE COMPUTER.

---

---

### CAUTION

STATIC DISCHARGE CAN DESTROY COMPONENTS ON A MEMORY CARD. HANDLE THE CARD USING ITS ANTI-STATIC ENVELOPE. DO NOT TOUCH THE ELECTRICAL TRACES OR SET THE CARD ON ANY STATICALLY CHARGED SURFACE (E.G., CLOTH).

---

You can have up to eight memory cards in your computer. They can be eight HP 98256A 256K byte cards, seven HP 98257A 1M byte cards, or any combination of the two up to 7.25M bytes. Here is a picture of memory cards installed in the backplane:

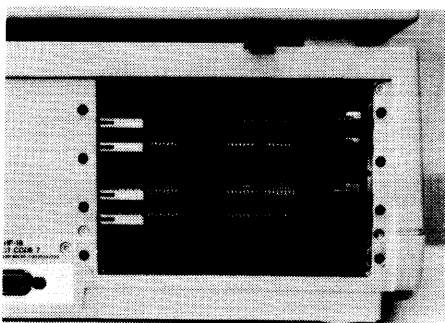

**Memory Cards Installed**

To install additional memory cards in your computer, first remove the accessory slot covers by turning the thumbscrews counterclockwise.

---

**Note**

You must set addresses contiguously. If there is an address gap, RAM cards set to addresses lower than the gap will not be recognized by the system.

---

Then orient your memory cards on a table or desk according to the two illustrations that follow and set the address switches as shown in the Memory Card Switch Settings table. Go to the section of that table which corresponds with the number of HP 98257A cards that you have. Then set switches on all memory cards exactly as shown.

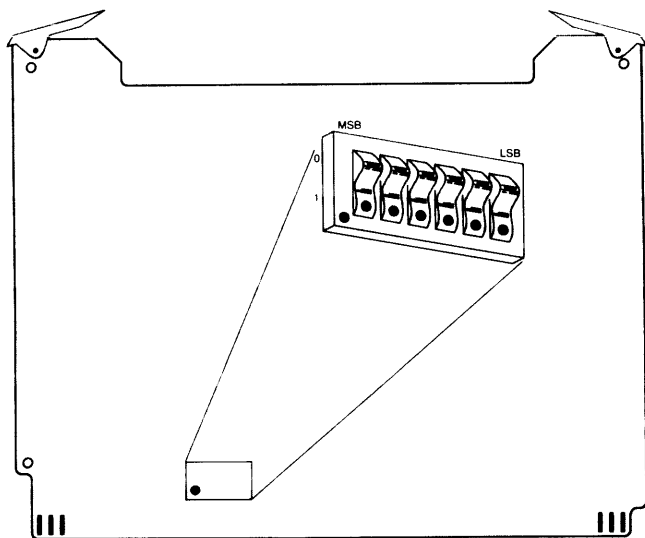



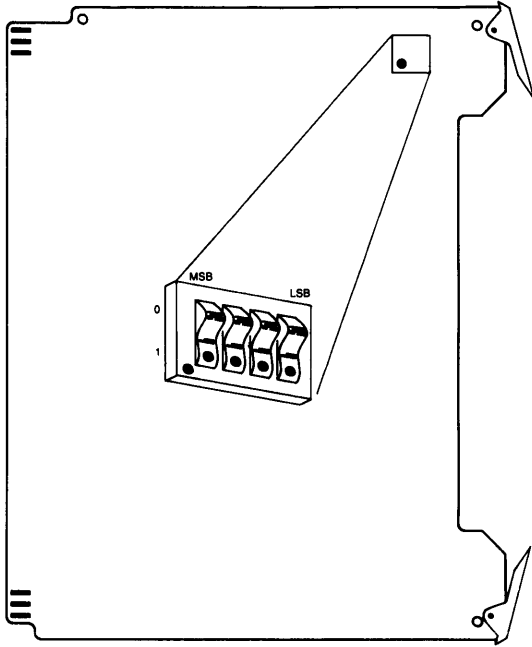



























































**HP 98256A Address Switches**



**HP 98257A Address Switches**

## Memory Card Switch Settings

Number of HP 98257A Cards	Settings for HP 98257A Cards	Settings for HP 98256A Cards
0		Card 1:  Card 2:  Card 3:  Card 4:  Card 5:  Card 6:  Card 7:  Card 8: 
1	Card 1: 	Card 1:  Card 2:  Card 3:  Card 4:  Card 5:  Card 6:  Card 7: 
2	Card 1:  Card 2: 	Card 1:  Card 2:  Card 3:  Card 4:  Card 5:  Card 6: 
3	Card 1:  Card 2:  Card 3: 	Card 1:  Card 2:  Card 3:  Card 4:  Card 5: 

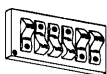
Number of HP 98257A Cards	Settings for HP 98257A Cards	Settings for HP 98256A Cards
4	Card 1:  Card 2:  Card 3:  Card 4: 	Card 1:  Card 2:  Card 3:  Card 4: 
5	Card 1:  Card 2:  Card 3:  Card 4:  Card 5: 	Card 1:  Card 2:  Card 3: 
6	Card 1:  Card 2:  Card 3:  Card 4:  Card 5:  Card 6: 	Card 1:  Card 2: 
7	Card 1:  Card 2:  Card 3:  Card 4:  Card 5:  Card 6:  Card 7: 	Card 1: 

## 24.4

Slide a memory card into its pre-assigned accessory slot, component-side up. Push the card firmly into place with its extractors until they are flush with the back of the computer. Repeat this procedure for every memory card.

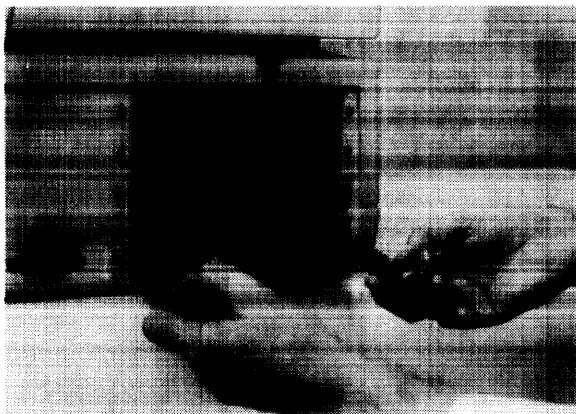

**Inserting a Memory Card**



**Seating a Memory Card**

---

**Note**

The RAM cards need more force to install them than seems reasonable. Compare the two cards in this Figure to see whether your RAM cards are correctly installed.

---

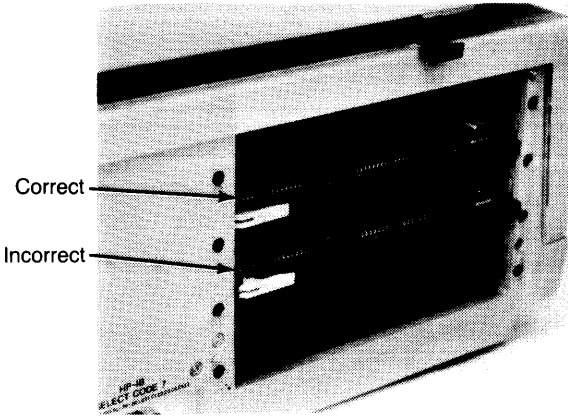
**Correctly and Incorrectly Installed RAM Cards**

Verify the added memory by turning your computer on and checking the number of bytes of memory displayed on the screen. Memory should increase by about 262 144 bytes for every HP 98256 256K byte RAM card, and about 1 048 576 for every HP 98257 1M byte RAM card.

### 3. Configure and Install Your Interfaces

---

#### HP-UX Note!

If you are going to run HP-UX on your computer, you must have an HP 98625A High-speed Disc Interface. You may have one or two HP 98624A HP-IB Interfaces, an HP 98626A Asynchronous Serial Interface, and/or an HP 98628A Datacomm Interface. Refer to Chapter 7, under the heading "Installing Backplane Accessories", for configuration procedures for these interfaces.

---

#### CAUTION

SWITCH OFF THE COMPUTER BEFORE INSTALLING AN INTERFACE CARD. PLUGGING OR UNPLUGGING A CARD WITH THE POWER ON CAN DAMAGE THE CARD AND THE COMPUTER.

---

#### CAUTION

STATIC DISCHARGE CAN DESTROY COMPONENTS ON AN INTERFACE CARD. HANDLE THE CARD USING ITS ANTISTATIC ENVELOPE. DO NOT TOUCH THE ELECTRICAL TRACES OR SET THE CARD ON ANY STATICALLY CHARGED SURFACE (E.G., A CLOTH).

---

Remove the interface from its anti-static envelope. The interface card has its factory-set select code prominently marked on the backplane cover which is attached to the card. The factory-set select code will usually not conflict with your other interfaces.

Each interface has a group of switches for setting the select code. Refer to the interface's installation manual to locate the select code switches. Check the select code switches on the interface card and reset if necessary.

Keep in mind the following restrictions:

- Don't use select code 7. It is reserved for the built-in HP-IB interface.
- When using BASIC or Pascal, don't use select codes 0 through 6—they are reserved by the language system.
- When using HP-UX, don't use select codes 8, 9, and 14 except as described in Chapter 7.
- When using HPL, don't use select codes 0 through 6 or 16 through 31—they are reserved by the HPL language system.



Set any other switches which may be on the interface card. These switches control various functions of the interface. Refer to the installation manual for instructions on setting these switches before you insert the card into your computer.

Insert the interface card into its pre-assigned accessory slot and tighten the thumbscrews until the interface backplane cover is flush with the back of the computer.

Verify the installed interface card by turning the computer on. The computer verifies the card's presence by listing the interface product number and its select code during self-test. For example:

HP98622 at 12

Repeat the above procedure for each interface card you're installing. Your computer can accommodate up to four interface cards. If you want additional interface card capacity, contact your HP Sales Representative about the HP 9888A Backplane Expander.

---

#### **Problems?**

If an interface you just installed fails to appear in the self-test list when you turn your computer on, double-check all switch settings and make sure the card is securely seated in the accessory slot. If the interface still fails to appear after checking these steps, turn your computer off, remove the interface card, and return it to its anti-static envelope. Then contact your HP Service Representative for help.

---



# Installing HP-IB Peripherals

Chapter

4

This chapter describes how to connect peripheral devices to the HP-IB interface. To find out if your peripheral conforms to the HP-IB standard, look for the letters "HP-IB" near the socket on the device, or consult the manual that came with the device.

## HP-IB Peripheral Devices

The following HP-IB peripheral devices are supported on your computer:

### Disc Drives

7908P	16 Mb Hard
7911P/R	27 Mb Hard
7912P/R	64 Mb Hard
7914P/R	132 Mb Hard
7933H	404 Mb Hard
7935H	404 Mb Hard
82901M/S	5¼-inch Flexible
82902M/S	5¼-inch Flexible
9121D/S	3½-inch Flexible
9130G	5¼-inch Internal Flexible
9133A/B	9134A/B + 9121S
9133V/XV	9134V/XV + 9121S
9134A/B	5/10 Mb Winchester
9134X/V	15 Mb Winchester
9135A	9134A + 82902M
9895A	8-inch Master Flexible

### Tape Drives

7971A	1600 bpi Magnetic
88140K	Cartridge

**Printers**

2563A	300 lpm Matrix
2602A	Daisy Wheel
2608A	400 lpm Matrix
2608S	400 lpm Matrix
2631B/G	180 cps Matrix
2671A/G	120 cps Thermal
2673A	120 cps Thermal
2688A	12 ppm Laser
2932A	200 cps Matrix
2934A	2932A + fonts + letter
82905A/B	80 cps Matrix
82906A	160 cps Matrix
9876A	480 lpm Thermal

**Graphics Devices**

7225B	1-pen Plotter
7245B	Printer/Plotter
7470A	2-pen Plotter
7475A	6-pen Plotter
7580A/B	8-pen D-size Plotter
7585A/B	8-pen E-size Plotter
9111A/T	Tablet
9872B/C/S/T	8-pen Flatbed Plotter

**Instruments**

6942A	Multiprogrammer
-------	-----------------

## What is the HP-IB?

In 1975, the Institute of Electrical and Electronic Engineers (IEEE) decided the interfacing situation was getting out of hand. Interfaces were springing up everywhere, each designed to optimize communication between a specific computer and a specific peripheral device. Unless this situation was contained, eventually every peripheral would require its own specialized interface.

The result was IEEE Standard 488-1975: the IEEE Standard Digital Interface for Programmable Instrumentation. This version was revised in 1978 into its current form, IEEE Std 488-1978. Hewlett-Packard's version of the IEEE Std 488-1978 is the HP-IB, which stands for Hewlett-Packard Interface Bus.

## How the Bus Works

The HP-IB is a bus. A bus is nothing more than a bundle of parallel wires over which several devices can communicate. Where most interfaces can support only a single peripheral, the bus architecture of the HP-IB allows up to 14 devices to be connected. This makes efficient use of resources, but requires some additional management if things are to run smoothly. Fortunately, the HP-IB manages itself; virtually all you have to do is connect your peripherals to it and let the bus do the rest.

Think of the bus as a party line shared by several telephones. If everyone wanted to talk at once, the messages would be garbled and no one could understand anything. The HP-IB avoids this situation by assigning roles to its devices. Any device capable of receiving information from the bus is called a **listener**. Any device able to send information over the bus is called a **talker**. Any device capable of regulating the bus (usually a computer) is called a **controller**. Each role is described in more detail below.

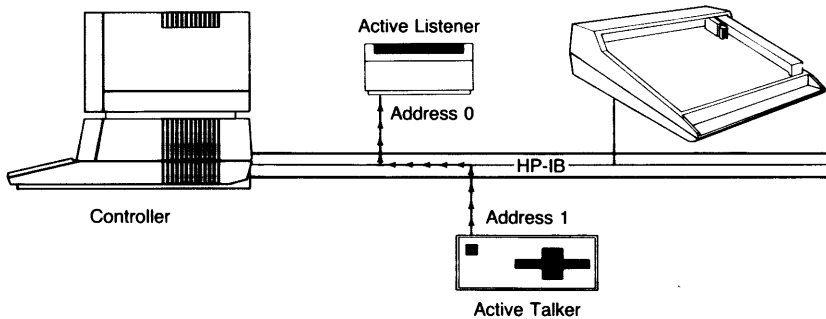

### Communication on the HP-IB

#### The Controller

The party line approach is simple and efficient, but can quickly turn to chaos if everyone tries to talk at once. Obviously, someone has to take command of the bus and decide who should talk and who should listen. On the party line, this person is the operator. On the HP-IB, it is the controller.

The controller is usually the computer itself. It takes requests to talk from the peripherals on the bus and decides which ones will be honored immediately and which ones will have to wait. As on the party line, if an emergency request comes through, it will take priority over casual gossip.

The computer is set at the factory to be the system controller on the built-in HP-IB. The system controller has the most control over other devices on the HP-IB. If you wish to designate another device as the system controller, you can set the computer to not automatically be the system controller by moving an internal jumper.

The system controller jumper is located in the card cage, below the bottom accessory slot (see illustration). When the jumper is in the right-hand position, the computer is the system controller. When the jumper is in the left-hand position, the computer is not the system controller.

---

**CAUTION**

SWITCH THE COMPUTER OFF BEFORE REMOVING CARDS OR MOVING THE SYSTEM CONTROLLER JUMPER. OTHERWISE, THE COMPUTER COULD BE DAMAGED.

---

---

**HP-UX Note!**

If your computer will run HP-UX, the system controller jumper must be in the system controller (right-hand) position.

---

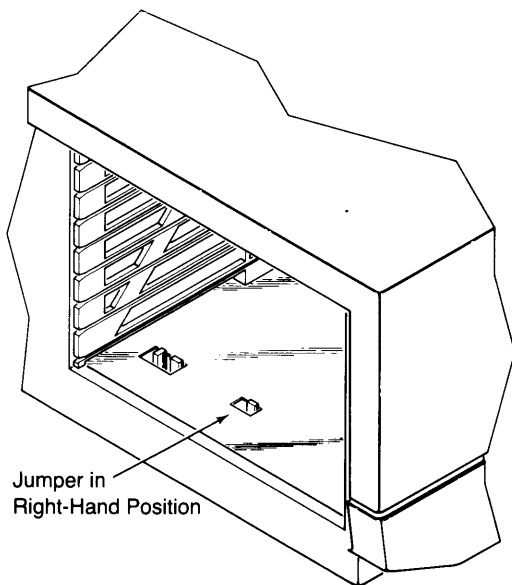

**Internal HP-IB Configuration Jumper**

On optional HP-IB interface cards, the system controller status is determined by a switch setting. See the HP-IB installation note supplied with the card for further details.

## The Talkers

To prevent messages from becoming garbled, the operator allows only one person to talk at a time. On the bus, computers, disc drives, and other input devices are called talkers. When a talker wants to transfer some information, it sends a request to talk to the controller and specifies which device(s) it wants to talk to. When the request is honored, the talker takes control of the bus and begins transmitting the information. All peripherals not designated as active listeners can't receive the information—the controller, in effect, tells them to hang up.

## The Listeners

On the party line, several people can listen at once. On the bus, disc drives, printers, plotters and other output devices are called listeners. Listeners just wait around for someone to call them. When the call comes, they signal that they are ready to listen, and then wait intently for the information to come.

## Bus Addresses

Even on a party line, everyone must have a phone number. Without it, the operator could not specify who should talk, who should listen, and who should hang up. On the bus, every device is given a unique **address**. The address is usually set with switches located next to the HP-IB socket of each device. The controller uses the address to selectively access individual peripherals on the bus.



# Setting Up and Connecting Your HP-IB Peripherals

---

## HP-UX Note!

If you are installing an HP-UX system, you will configure at least two HP-IB buses: a system bus and an internal bus. You may also configure one or more external HP-IB buses. You must configure the HP-IB buses and HP-IB peripheral device addresses specifically for HP-UX. The HP 98625A High-speed Disc Interface drives the system bus. Refer to Chapter 7, under the heading "Installing HP-IB Peripherals", for more information before continuing.

---

If you will not have HP-UX, you will configure an internal bus and, optionally, one or more external buses.

The internal HP-IB interface drives the internal bus; its connector is on the back of the computer. The HP 98624A HP-IB Interface drives the external bus. Up to 14 peripheral devices can be interconnected on a bus.

Configure and install the buses in this order: 1) system (if HP-UX), 2) internal, 3) external(s) (if any). Perform the following procedures for **each** HP-IB bus that you are configuring.

1. Install your HP-IB peripheral devices in their normal operating positions, connect their power cables, and run their stand-alone self-tests.
2. Turn off all the peripheral devices, and ensure that the computer power switch is "off".
3. Set the address switches on each peripheral device to a unique address. Most HP-IB peripherals have a set of address switches next to the HP-IB socket. If you cannot locate or understand the switches, refer to the peripheral device's installation manual.

If you have only one device of each type connected to your computer (e.g., one printer, one disc drive and one plotter), you probably won't need to alter the factory-set addresses.<sup>1</sup> Change the bus address only if two peripherals are set to the same address.

<sup>1</sup> The *flexible* disc drive in the HP 9133 and 9135 devices is set at the factory to address 1. Since all HP printers are also shipped with address 1, you must change the primary address of either the flexible disc drive or the printer.

The factory address settings for common peripherals are shown below.

Peripheral Type	Factory Address Setting
HP-IB Disc Drives	00
HP-IB Printers	01
HP-IB Plotters	05
HP-IB Graphics Tablet	06

- Select a peripheral device to attach directly to the computer.
- Press the HP-IB cable plug into your peripheral's HP-IB socket and secure the connection with the thumbscrews. The plug and socket fit together in only one way, so if you're having difficulty making the connection, rotate the plug 180° and try again.

---

**Note**

A 2-metre cable is supplied with the computer. Additional cables are available from our Computer Supplies Operation. In the United States, call either 800-538-8787 or 408-738-4133.

---

Length	Part Number
1 metre	10833A
2 metres	10833B
4 metres	10833C
½ metre	10833D

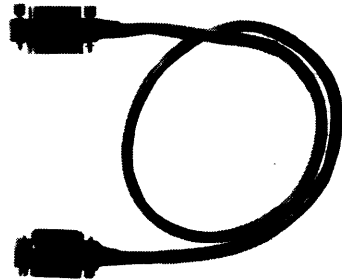

**Available HP-IB Cables**

- Connect the other end of the HP-IB cable to the HP-IB socket on the computer (internal HP-IB socket for the internal bus, HP 98625A socket for the system bus, or HP 98624A socket for the external bus).
- Interconnect all the other peripheral devices to the bus with HP-IB cables subject to the following guidelines:
  - You can interconnect up to 14 peripheral devices on one bus system.

- You can interconnect your peripherals any way you want as long as there is an unbroken link between any given peripheral and the computer.
- You can connect more than one HP-IB cable to the same connector in piggyback fashion. However, do not stack more than three connectors on one device, as the weight of the connectors could damage the device socket.
- The total length of cable in one bus must be less than or equal to two metres times the number of devices connected together (the interface card is counted as one device). However, the total length of cable must not exceed 20 feet.

For example, a system containing six devices (including the interface) can be connected together with cables that have a total length less than or equal to 12 metres (six devices x 2m/device = 12 metres). The individual lengths of cable can be distributed in any manner desired as long as the total length does not exceed the allowed maximum. If more than 10 devices are to be connected together, cables shorter than two metres must be used between some of the devices to keep the total cable length less than 20 metres.

**Repeat steps 1 through 7 for each bus you are configuring.**



# Installing Non-HP-IB Peripherals

Chapter

5

---

### HP-UX Note!

If you're installing an HP-UX computer, refer to Chapter 7, under the heading "Installing Non-HP-IB Peripherals" for HP-UX-specific guidelines.

---

This chapter lists supported non-HP-IB peripheral devices and their associated interfaces. It also gives an introduction to data communications.

You configured and installed the interfaces as described in Chapter 3. Install the peripheral devices and connect them to the interfaces according to the manuals which came with the peripherals.

## Non-HP-IB Peripheral Devices

The following non-HP-IB peripheral devices are supported on your computer.

---

Peripheral	Interface
9885M/S 8-inch Flexible Disc Drive	98622A GPIO
2601A Daisy Wheel Printer	98626A Asynchronous Serial
13279B 19-inch Color Monitor	98627A Color Video
13264A Data Link Pod	98628A Datacomm
13265A 300 Baud Modem Pod	98626A Asynchronous Serial
	98628A Datacomm
	98629A SRM
	98691A Programmable Datacomm
39800A/01A Bar Code Reader	98626A Asynchronous Serial
	98628A Datacomm
6944A Multiprogrammer	98633A Multiprogrammer

---

### HP-UX Note!

HP-UX supports several terminals that are not supported by other languages.

---

## Data Communications (Datacomm)

The rest of this chapter describes some guidelines for using the following data communications (datacomm) interfaces:

- HP 98626A Asynchronous Serial Interface
- HP 98628A Datacomm Interface
- HP 98691A Programmable Datacomm Interface

Because the datacomm interface is not standardized, each device you connect must be considered on an individual basis. Thus, no procedures are provided in this chapter.

For information about programming the data communications interface, refer to the appropriate operating system or programming language manual.

### What is the Data Communications Interface?

Technically speaking, the data communications interface conforms to the RS-232C electrical standard adopted by the Electronic Industries Association (EIA). RS-232C defines the electrical characteristics of an interface between a piece of data terminal equipment (**DTE**) and a piece of data communications equipment (**DCE**). For most applications, the piece of data terminal equipment is your computer, and the piece of data communications equipment is a modem.

Non-technically speaking, the data communications interface allows you to use your computer like a terminal to send information to, and receive information from, another computer. The connection between your computer and the other computer may be direct if the distance between them is short, or it may be over telephone lines if the distance is long. When telephone lines are used, the data communications interface is used to connect your computer to a **modem**. The modem encodes computer data into a form suitable for transmission over telephone lines, and decodes signals received from the telephone line back into a computer-readable form.

The data communications interface can also be used to connect a variety of low-cost peripherals to your computer. However, because the interface was not actually designed with this purpose in mind, the cable connection between the computer and the peripheral may require an adapter cable or some cross-wiring.

## Data Communications Concepts

All information can be represented as words and numbers. Words and numbers can be represented by characters (letters and numerals). The message HELLO is represented with the four alphabetic characters “H”, “E”, “L” and “O,” while the number 10 is represented by the numeric characters “1” and “0.”

Since computers store and process information, they must be able to store and process characters. In your computer, characters are encoded into a pattern of ones and zeroes before they are stored. For example, the letter H looks like this when it is stored in the computer:

H → 01001000

Each binary digit (i.e., a “1” or a “0”) of the encoded character is called a **bit**. The codes for the rest of the characters in HELLO are:

E → 01000101

L → 01001100

O → 01001111

If we wanted to send the message HELLO to another computer, the best way would be to have eight parallel wires running between the computers, one for each bit of a character. Then transmissions could occur one character at a time:

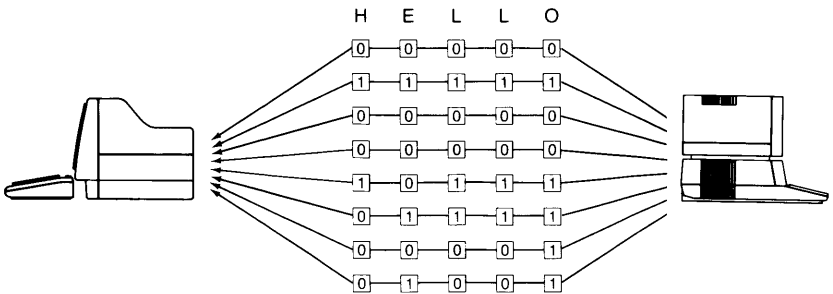

**Parallel Transmission**

This is, in fact, how the HP-IB works. But telephone lines don't have parallel wires, they only have one. So each character will have to be disassembled and sent over the wire one bit at a time, then reassembled by the receiver. This is called **serial** transmission. The transmission of the character "H" would look like this:

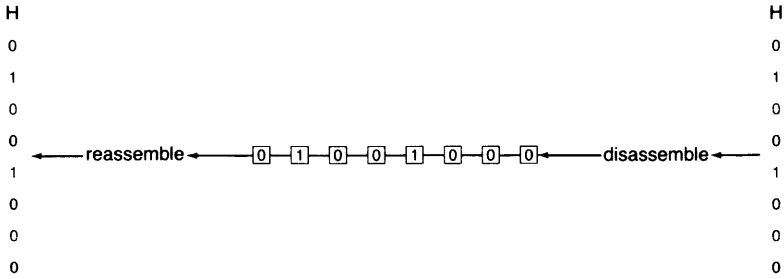

### Serial Transmission

The preceding illustration shows the transmission of a single character. But what happens when several characters are transmitted, one after the other? The line would just be one long string of 1s and 0s. How can the receiver tell where one character ends and another begins?

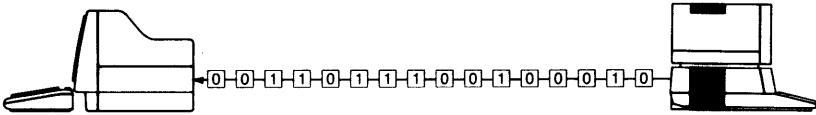

### Indistinguishable Characters

First of all, the sender and receiver must agree on how many bits there are in a character. If the sender thinks there are eight bits in a character and the receiver thinks there are only five, the message will be garbled. If the sender and receiver agree that eight bits are needed to represent one character, then when the receiver finds the first bit, it knows that the following seven bits are part of the same character. But for the transmission to work, there must be a way for the receiver to identify the first bit.



To solve this problem, special **start bits** and **stop bits** are sent before and after each character, respectively. There is always one start bit per character, and it signals the receiver that the next eight bits (or whatever number of bits was agreed upon) will represent a character. Following the character are between 1 and 2 stop bits that allow the receiver time to get ready for the next character. Both sender and receiver must agree on the number of stop bits to be used.

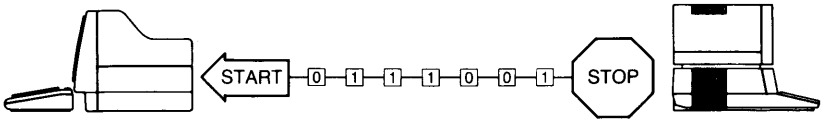

### Distinguishable Character

Now the sender and receiver understand each other. They both use the same character coding format, and agree upon the character delimiters. Nothing can go wrong, right? Wrong. What would happen if the sender sends information to the receiver faster than the receiver can read it? Again, the transmission will be garbled.

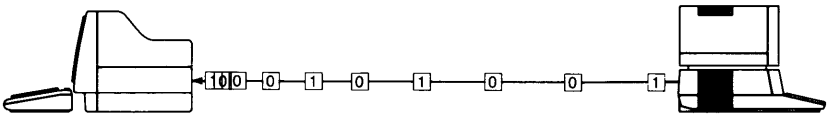

### Transmission Rate Problem

The solution is to set the transmission rate of the sender to a level equal to or lower than the maximum rate at which the receiver can accept data. This rate is called the **baud rate**, and is simply the number of bits transmitted by the sender every second. Baud rates can range from 50 to 19 200 bits per second.

One final note. Even when everything between the sender and the receiver is set correctly, errors in transmission will occasionally occur. It would be nice if the receiver could detect these errors and ask the sender to retransmit the garbled information. This is possible by adding an extra bit to each character, called a **parity bit**. The value of the parity bit depends on the parity type that the sender and receiver agree upon.

**Odd parity** will set the parity bit so that the total number of ones in the character (including the parity bit) is an odd number. For example, if odd parity is used, the parity bit for the letter H will be set to 1 in order to make the total number of ones in the character odd.

H	Parity Bit
01001000	1

Total number of ones in character = 3 (odd parity)

**Even parity** sets the parity bit so that the total number of ones in the character is even. Using even parity, the parity bit for the letter H would be 0.

H	Parity Bit
01001000	0

Total number of ones in character = 2 (even parity)

Other parity schemes are available that always set the parity bit the same, either to a one or to zero.

If the sender and receiver agree to use *odd* parity, and a character is received containing an *even* number of ones, then an error has occurred in the transmission of that character. The receiver can detect this and ask to have the character retransmitted.

## Cable Connections

Assuming you've set the switches on your interface card and installed the card in your computer (Chapter 3), you can now physically interconnect the device and interface with a cable.

Two cables are available. The DTE (Data Terminal Equipment) cable has a 25-pin **male** connector on one end, and a 50-pin connector on the other. The 50-pin connector plugs into the data communications interface installed in your computer, while the 25-pin male connector plugs into the other type of cable: the DCE (Data Communication Equipment) cable. The DCE cable has a 25-pin **female** connector to match the DTE male connector, and also has a 50-pin connector for connecting to your computer.

The following photos show the DTE and DCE connectors. The plastic housing around your connectors may differ, but the pin configuration will be the same.

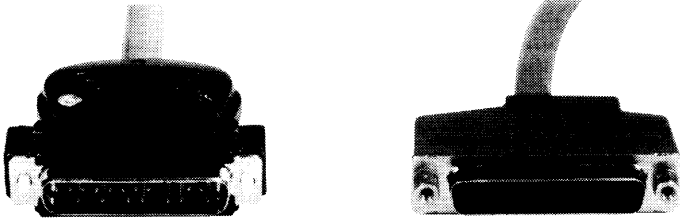

### DTE Cable with Male Connector    DCE Cable with Female Connector

The type of cable you need for your computer depends on the type of device you are connecting to it. Some guidelines are given below.

#### Connecting a Modem

All modems are considered data communication equipment, and should come equipped with a female (DCE) cable or socket. Your computer, therefore, is playing the role of the data terminal equipment, and should use a male (DTE) cable.

Connect the 50-pin connector of the DTE cable to the data communications socket on your installed interface. Connect the 25-pin male connector on the other end of the DTE cable to the female (DCE) connector supplied with the modem. Secure the connection with the fasteners.

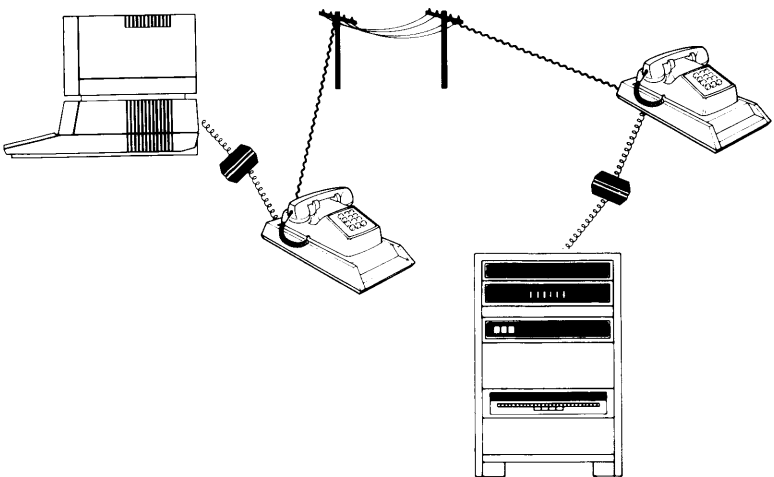

### Connecting Your Computer to a Modem

### Connecting Another Computer or Terminal

When connecting your computer back-to-back with another computer or terminal, you will normally use a DCE cable. The other computer or terminal will generally have the DTE cable or socket attached to it.

Connect the 50-pin connector of the DCE cable to the data communications socket on your installed interface. Connect the 25-pin female connector on the other end of the DCE cable to the male (DTE) connector attached to the other computer or terminal. Secure the connection with the fasteners.

If, for some reason, the other computer is equipped with a female (DCE) connector, use the male (DTE) cable for your computer. The important thing to remember when connecting two computers directly is that one must have a male cable and the other must have a female cable.

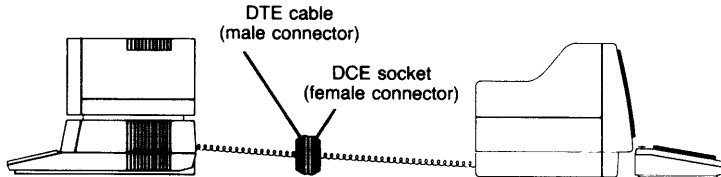

### Connecting Your Computer to Another Computer

#### Connecting RS-232C Peripherals With DCE Connectors

If your peripheral has a female DCE connector, you should be able to connect it directly to your installed interface using a male DTE cable. The only problem might be that the peripheral requires signals not provided by the interface. Not all of the pin functions defined in the EIA Std RS-232C interface are available on your interface.

Connect the 50-pin connector of the DTE cable to the data communications socket on your installed interface. Connect the 25-pin male connector on the other end of the DTE cable to the female (DCE) connector supplied with the peripheral. Secure the connection with the fasteners.

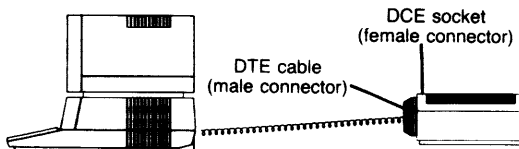

### Connecting Your Computer to a DCE Peripheral

## Connecting RS-232C Peripherals With DTE Connectors

Line printers and other peripheral devices that use the data communications interface are frequently *wired* as DTE but have a *female* connector instead of the usual male. This means that if you use a male (DTE) cable to connect to the *female* DTE device connector, no communication can take place because the signal paths are incompatible.

To get around this problem, use an adapter cable with male connectors at both ends. The adapter cable effectively converts the peripheral's female DTE connector into the common male DTE connector. Then you can run a female DCE cable from the interface to the adapter cable.

Several adapter cables are available to solve problems like the one discussed above. Contact your HP Sales Representative for advice on selecting an adapter cable.

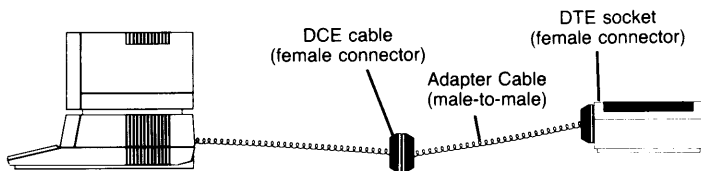

## Connecting Your Computer to a DTE Peripheral

### Terminal Emulation

If using the data communication interface to communicate with a central host computer, you will need a program to run on your computer that simulates the operation of a terminal. The Series 200 Asynchronous Terminal Emulator (part number 09800-10380 for 3½ inch disc or 09800-10580 for 5¼ inch disc) was developed specifically for this purpose.

The Terminal Emulator makes your computer act like an HP 2621 intelligent terminal. With it, you can “log on” to the host computer and transfer data without having to write your own program. See your HP Sales Representative for details.



# Reading the Self-Test

Chapter

6

Computers can be valuable time-savers, but only if they are operating reliably. If a problem goes undetected and your computer fails in the middle of a job, data can be lost and hours of your labor may be wasted.

Your computer minimizes this risk by performing a self-test every time you turn it on. In this way, most problems are caught before you start to work, sparing you the frustration of a mid-session failure.

In this chapter, we describe how to interpret the self-test messages and suggest what you should do in case of a failure.

## Self-Test Messages

Turn your computer on or press **RESET** (**SHIFT**-**PAUSE**). Notice the messages appearing along the left-hand side of the screen. Compare your display to this one.

```
9836C  
Copyright 1984,  
Hewlett-Packard Company,  
All Rights Reserved.
```

```
BOOTROM 4.0  
Keyboard  
Color Graphics  
HP-IB  
261984 Bytes
```

```
SEARCHING FOR A SYSTEM (ENTER To Pause)  
RESET TO Power-UP
```

The lines under the `BOOTROM` message tell you that each major component in your computer has just been tested. If the component passed the test, a **status message** is displayed; if the component failed the test, an **error message** will appear.

Boot ROMs earlier than revision 3.0 do keyboard and RAM tests before loading an operating system. You can tell if your computer has an early boot ROM by watching the display at powerup. If this message is displayed:

```
MEMORY TEST IN PROGRESS
```

you have an early boot ROM. Error messages from early boot ROMs are listed at the back of this chapter.

## Status Messages

Usually, each component will pass its test and only status messages will be displayed. The first two status messages, `Keyboard` and `Color Graphics`, tell you that the keyboard and the screen's graphics display, respectively, are working properly.

The next message reports that your computer's built-in HP-IB interface is functional. If you added another interface to your computer, its name and select code would be listed also.

The final status message in the self-test list shows that memory has passed its test. While the memory test is in progress, the message:

```
TESTING MEMORY
```

appears at the bottom of the screen. Press **RESET** if you want to re-start the self-test and see this message. When the memory test is finished, the number of bytes of RAM is reported in the self-test list (e.g., `261984 Bytes`).

## Error Messages

If a component fails its test, an error message is displayed in place of the usual status message. There are several types of error messages; we'll discuss a few of them here and list the rest in the Error Message tables at the back of this chapter.



Some failures occur because the computer can't find a component that it expects to see. In this case, it reports that component missing. For example:

```
Keyboard Missing
```

This message doesn't mean that the keyboard is physically missing; it means that the computer couldn't find the electronic components that control the keyboard. You might also get the message:

```
Keyboard Failed
```

This means that the computer found the keyboard's electronics, but it wasn't happy with what it found. Both of these messages indicate a problem that an HP service representative should look at.

After displaying an error message, the computer moves on to the next component in the self-test list. After all components are tested, the computer looks for a program or language to load, or displays the message:

```
WAITING 1 MINUTE (ENTER To Abort Wait)
```

This message tells you that the computer found at least one error and it's giving you a minute to read the error message(s) on the screen. You can press **ENTER** to terminate the waiting period.

## Boot ROM Beeper

In addition to displaying an error and waiting a minute, the Boot ROM 4.0 sounds a pattern of beeps. The boot ROM is actually sending an error message to a service person. If this error pattern is sounded, check the display for an error message. Refer to the Boot ROM 4.0 Error Messages list at the back of this chapter. If the message indicates something you cannot correct, or if the display is not working, you should call HP for service. Your service representative may ask you to restart the self-test so he can listen to the error code sounded.

After the error pattern has sounded, the boot ROM searches for a system to load. If you want to cancel the one-minute delay and the beeps, you can press **ENTER**. The boot ROM will then display any operating systems found and wait for you to specify which system you want loaded.

## Boot ROM Errors

If the computer detects a problem with the boot ROM, it displays the message:

```
CONTINUE AT OWN RISK (ENTER To Continue)
```

The computer will do nothing further until you press the **ENTER** key. Your computer is somewhat unpredictable in this state and could alter the programs that you want to load from a disc. Therefore, if you decide to continue, make sure you have extra copies of any discs or programs that the boot ROM might access.

## Running an Extended Memory Test

If you wish to run a more complete test of all RAM in the computer, press this sequence during the self-test:

**CTRL** - **C**

When the Configure menu appears, press:

**T**

The boot ROM will restart the self-test and run a longer RAM test. This test may catch intermittent problems not seen by the power-up self-test.

## What to Do When Errors Occur

Very few self-test errors are serious enough to require service. When an error is reported, always run the self-test again and see if the error is repeated.

If the same error is reported a second time, look up the message in the appropriate Error Messages table which follows in this chapter. There you'll find a list of errors which you can often correct yourself. Make the recommended adjustment and run the self-test again. If the same error is reported, or if the error message you get doesn't appear in the Error Messages table, call HP for help.

## Where to Get Help

When your computer develops a problem that you cannot correct yourself, you should return it to one of the Hewlett-Packard Field Repair Centers. A number of service contracts are available. See Appendix A, Sales and Service, for servicing details.

## Boot ROM 3.0 and 4.0 Error Messages

This section lists error messages sent by boot ROM 3.0 and 4.0. We have tried to anticipate some errors you might receive that indicate a hardware mis-configuration rather than a failure. If you still receive the error after making the recommended adjustment, it means that there is a real problem; call HP for service.

Error Message	Description and Recovery Action
WAITING 1 MINUTE (ENTER To Abort Wait)	The self-test found a failure. After evaluating the message, either press <b>ENTER</b> to begin the booting process or call HP for service.
RAM FAILED ABOVE xxxxxx	A memory failure has occurred. Call HP for service.
RAM GONE ABOVE xxxxxx	The boot ROM couldn't find RAM. Either the address switches on a RAM card are not set correctly or the memory has failed. Check the switches (refer to Chapter 3). Call HP for service if the error is repeated after another powerup.
HP-IB Failed	Either more than half of the devices on the HP-IB interface are turned OFF or a device on the HP-IB has failed the self-test. First turn each device on or disconnect it. Then run the self-test again. If the message is repeated, call for service.
CONTINUE AT OWN RISK (ENTER To Continue)	Errors detected in the boot ROM. Press <b>ENTER</b> to continue the self-test. Ensure you have a copy of every file the boot ROM may access. If the error persists, call HP for service.
UNEXPECTED USE OF xxxxxx	Indicates an unplanned system failure. Call HP for service.

## Early Boot ROM Error Messages

Error Message	Description and Recovery Action
MEMORY FAILURE AT nnnnnnnn	A memory board failed the power-up test. Check for more than one memory board set at the same starting address.
INSUFFICIENT USABLE MEMORY	Not enough read/write memory for boot ROM use. Call HP for service.
NOT ENOUGH MEMORY FOR SYSTEM	Insufficient read/write memory to load language system from disc. Check memory cards. Then press <b>RESET</b> ( <b>SHIFT</b> - <b>PAUSE</b> ) to load system. If error is repeated, call HP for service.
KEYBOARD FAILED SELF TEST	Power-up test failed. Switch computer off and try again. If failure repeats, call HP for service.
UNABLE TO FIND SYSTEM RESET TO RETRY	Language system not found in ROM or on disc (SYSTM type file). Insert a language system disc, close the drive door, and press <b>RESET</b> . If error is repeated or computer cannot find ROM system, switch computer off and call HP for service.
FATAL FLOPPY ERROR 90,11 DRIVE NOT RESPONDING	Disc drive hardware failure. Switch the computer off and call HP for service.
FLOPPY ERROR code, nn... RESET TO RETRY	Disc drive error occurred during system load. Refer to explanation of indicated BASIC error code. After remedying the problem, press <b>RESET</b> to load system. If error is repeated, call HP for service.
UNEXPECTED USE OF nnnnnn RESET TO RETRY	Hardware error. Press <b>RESET</b> to reload the language system. If the error is repeated, call HP for service.



# Setting Up for HP-UX

Chapter

7

---

**HP-UX Note!**

If you intend to load and use the HP-UX operating system, this chapter is for you! Keep reading!

If you will not use HP-UX, ignore this chapter.

---

The HP-UX operating system requires a specific computer system configuration. Therefore, you must install your computer system to satisfy the HP-UX requirements.

The topics in this chapter are organized in the same order as the installation sequence (Chapters 2 through 6), and the headings correspond to the chapter titles. As you install your system according to Chapters 2 through 6, you are referred to this chapter for HP-UX installation information and procedures.

---

**REMEMBER!**

DO NOT PERFORM THE PROCEDURES IN THIS CHAPTER UNTIL YOU'RE REFERRED TO THIS CHAPTER FROM OTHER CHAPTERS IN THE MANUAL.

---

You need the following hardware to load and run the HP-UX operating system:

- HP 9826U, HP 9836U, or HP 9836CU Computer
- Three HP 98256A 256K RAM Cards or one HP 98257A 1M RAM Card
- HP 98620B DMA Controller
- HP 98625A High-speed Disc Interface
- HP 7908, 7911, 7912, or 7914 Disc Drive, with cartridge tape drive

## Installing Your Computer

Install your HP-UX computer as described in Chapter 2.

### Installing Backplane Accessories

Backplane accessories include additional memory cards, other non-interface accessories like the DMA controller, and all interfaces.

#### Memory Requirements

You need a minimum of three HP 98256A 256K RAM Memory cards for HP-UX. Set the address configuration switches and install the cards as described in Chapter 3.

#### DMA Controller

You need an HP 98620B DMA Controller (part number 98620-66502) when using HP-UX. Install the DMA controller as described in Chapter 3.

#### HP 98625A High-speed Disc Interface

1. Set switches on your HP 98625A card as follows (see illustration):
  - a. Set Select Code switch to select code 14. Set Segments 4 and 0 to "0"; set Segments 3, 2, and 1 to "1".
  - b. Set Interrupt Level switch to interrupt level 4. Set Segment 1 to "0"; set Segment 0 to "1".

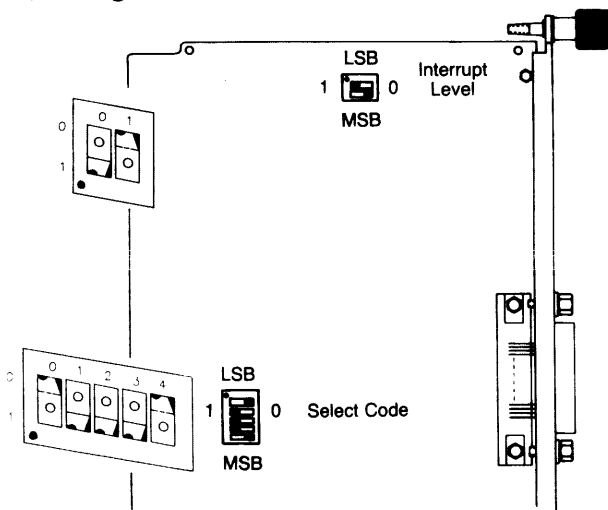

#### Configuring the HP 98625A High-speed Disc Interface for HP-UX



2. Install the HP 98625A interface card in your computer as described in Chapter 3.

## HP 98624A HP-IB Interface(s)

1. Set switches on your HP 98624A card(s) as follows (see illustration):
  - a. Set Select Code switch (U1) to select code 8 (for the first HP 98624A) or select code 9 (for the second HP 98624A, if used). For select code 8, set switch Segments 4, 2, 1, and 0 to "0", and Segment 3 to "1". For select code 9, set switch Segments 4, 2, and 1 to "0", and Segments 3 and 0 to "1".
  - b. Set Interrupt Level switch (U2) to interrupt level 3 by setting both switch segments to "0".
  - c. Set Address/System Controller switch (U17) to address 21 by setting Segments 4, 2, and 0 to "1", and Segments 3 and 1 to "0".
  - d. Set Address/System Controller switch (U17) to System Controller position by setting Segment 5 to "1".

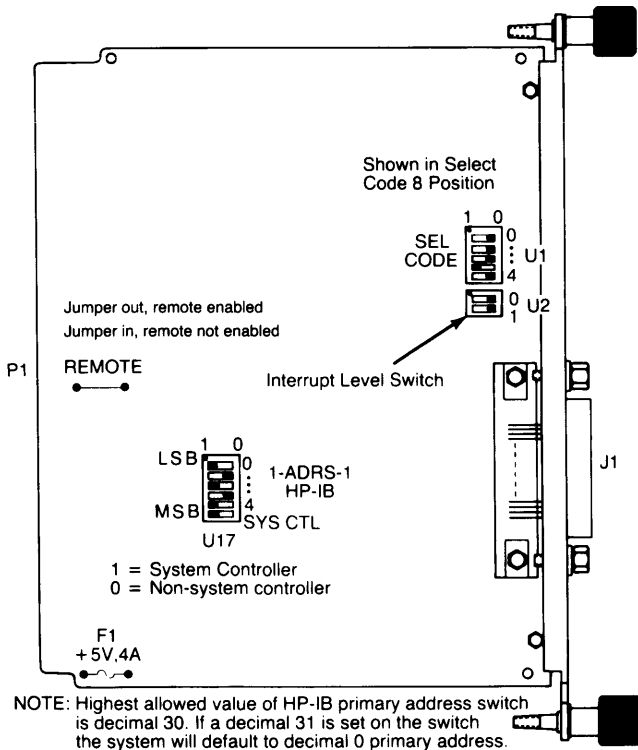

## Configuring the HP 98624A HP-IB Interface for HP-UX

2. Install the HP 98624A interface(s) in your computer as described in Chapter 3.

## HP 98626A Asynchronous Serial Interface/ HP 98628A Datacomm Interface

A terminal or remote computer is connected to the computer system through an HP 98626A Asynchronous Serial Interface or HP 98628A Datacomm Interface, both of which support the RS-232C datacomm standard. One interface is required for each terminal, and each interface must be set to a unique select code.

You can set the datacomm interface to any unused select code as shown in the following table. Select codes 0-9 and 14 have been used or are reserved.

**HP-UX Select Codes**

Select Code	Switch 43210	Select Code	Switch 43210
0-9, 14	Do not use	21	10101
10	01010	22	10110
11	01011	23	10111
12	01100	24	11000
13	01101	25	11001
15	01111	26	11010
16	10000	27	11011
17	10001	28	11100
18	10010	29	11101
19	10011	30	11110
20	10100	31	11111

### HP 98626A Asynchronous Serial Interface

1. Set the switches on your HP 98626A interface exactly as shown in the following illustration, with these considerations:
  - a. Set the select code switches to the desired select code (see preceding table). Select code 11 is set in the illustration as an example.
  - b. The remote keyboard jumper should **not** be removed.
  - c. The baud rate set switches (U1) are shown in the normal HP-UX default of 9600 bauds.
  - d. The line control switches (U2) are shown selecting these normal HP-UX defaults: 7 bits per character, 1 stop bit, even parity.

- e. The modem line switches (U3) should be set to the CONNECT position if your interface is connected to a modem. If the interface is connected directly to a terminal, set the switches to the ALWAYS ON position.

Refer to the installation manual that came with the interface for more information.

2. Install the HP 98626A interface card in your computer as described in Chapter 3.

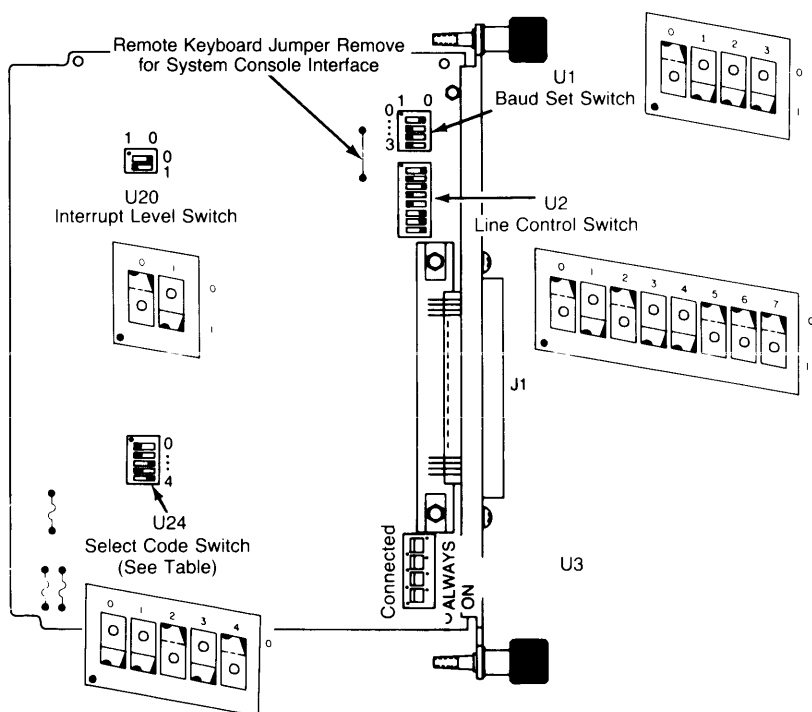

### HP 98626A Asynchronous Serial Interface Switches

#### HP 98628A Datacomm Interface

1. Set the switches on your HP 98628A interface exactly as shown in the following illustration, with these considerations:
  - a. Set the select code switches to the desired select code (see preceding table). Select code 20 is set in the illustration as an example.

- b. Default switches 7 and 6 select bits per character and parity type. Normal HP-UX default settings are shown in the illustration: 7 bits per character, even parity.
- c. Default switches 5 and 4 configure hardware handshake. Set the switches as shown if you have a direct connection with no modems. Set switch 4 to the opposite position if you are using a modem connection.
- d. Default switches 3, 2, and 1 set the baud rate and are shown set to 9600 bauds. If your datacomm line has a different speed, change the settings to match the speed.

Refer to the installation manual that came with the interface for more information.

2. Install the HP 98628A interface card in your computer as described in Chapter 3.

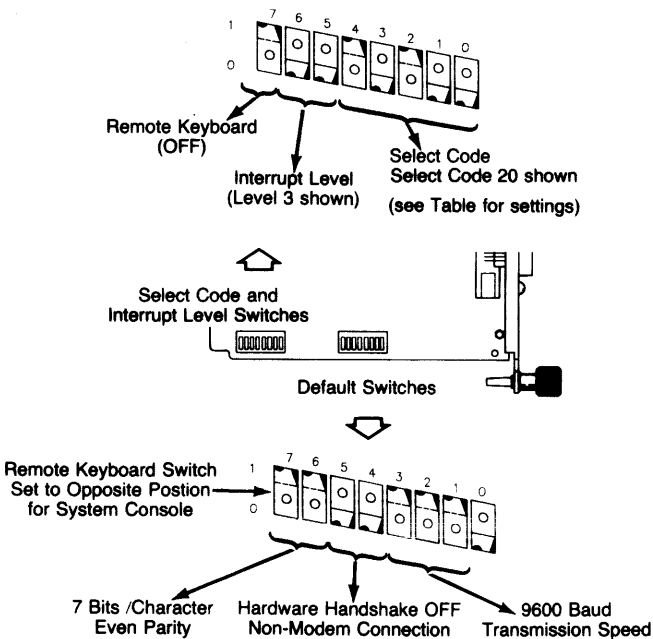

**HP 98628A Datacomm Interface Switches**

## Installing HP-IB Peripherals

You need two HP-IB buses for HP-UX: an internal bus and a system bus. A third bus, the external bus, is optional.

The internal bus is controlled by the internal HP-IB interface which is located below the accessory card cage. The HP-IB connector on the back of your computer allows you to connect the internal bus to peripheral devices. For HP-UX, the internal HP-IB interface must be set to be the system controller as described in Chapter 4.

The system bus is controlled by the HP 98625A High-speed Disc Interface which you installed earlier in the accessory card cage. Your HP-UX operating system requires a dedicated CS/80-type disc drive which stores the HP-UX file system. This dedicated disc drive is also called the "root" device. It must be an HP 7908, 7911, 7912, or 7914 disc drive with cartridge tape drive. The "root" device resides on the system bus.

The optional external bus provides additional HP-IB capability. Each external bus is controlled by an HP 98624A HP-IB Interface which you installed earlier in the accessory card cage.

When installing your HP-IB peripherals (Chapter 4), set the HP-IB bus addresses and install the peripherals as follows. Also refer to the HP-IB Bus Address Assignments table which follows the procedure.

1. Set the system CS/80 disc drive switches to HP-IB bus address 0. Connect the system drive HP-IB disc connector to the system bus (HP 98625A High-speed Disc Interface) with an HP-IB cable.
2. If your system CS/80 device has dual controllers, set the HP-IB tape address switches to HP-IB bus address 1. Connect the HP-IB tape connector to the system bus.
3. Set and install additional CS/80 disc drives as follows:

Drive 1: Internal Bus Address 0  
Drive 2: System Bus Address 6  
Drive 3: System Bus Address 7

4. Set and install non-CS/80 disc drives as follows:

Drive 1: Internal Bus Address 3  
Drive 2: Internal Bus Address 4  
Drive 3: Internal Bus Address 0 (See Note)  
Drive 4: System Bus Address 3 (See Note)  
Drive 5: System Bus Address 4 (See Note)  
Drive 6: System Bus Address 5 (See Note)

---

**Note**

Use only if Internal Bus Address 0 was not already assigned to an additional CS/80 drive (Step 3). Otherwise, set Drive 3 to System Bus Address 3, Drive 4 to System Bus Address 4, and Drive 5 to System Bus Address 5.

Do not connect the HP 9135, HP 82901, or HP 82902 drives to the system bus. Connect these drives to an external bus.

---

5. Set the system line printer to bus address 1, and install the printer on the internal bus.
6. Set the 9-track tape drive to bus address 2, and install the drive on the internal bus.
7. Install additional line printers at internal bus addresses 5, 6, and 7; or at external bus addresses 1 through 4 (HP 98624A HP-IB Interface). Do not connect printers on same bus with plotters/tablets, if possible.
8. Install plotters/tablets at unused internal bus addresses 1, 5, 6, and 7; or at external bus addresses 1 through 7. Do not connect plotters/tablets with printers, if possible.
9. Check all assignments to ensure that two or more devices are not assigned to the same bus address for each bus.

### HP-IB Bus Address Assignments for HP-UX

HP-IB Device	Bus Address		
	System	Internal	External
System CS/80 Disc	0		
System Tape Drive (if dual-controller device)	1		
Add'l CS/80 Disc #1		0	
Add'l CS/80 Disc #2	6		
Add'l CS/80 Disc #3	7		
Non-CS/80 Disc #1		3	
Non-CS/80 Disc #2		4	
Non-CS/80 Disc #3		0 (a)	
Non-CS/80 Disc #4	3 (b)		
Non-CS/80 Disc #5	4 (b)		
Non-CS/80 Disc #6	5 (b)		
9-Track Tape Drive		2	
System Line Printer		1	
Add'l Line Printer(s)		5,6,7 (c)	1-4 (c)
Plotter(s)/Tablet(s)		1,5,6,7 (c)	1-7 (c)

See table notes on next page.

- (a) Use only if there is no additional CS/80 Disc #1. Otherwise, use system bus address 3 for non-CS/80 Disc #3, and so on.
- (b) Do not connect the HP 9135, HP 82901, or HP 82902 to the system bus. Connect these drives to an external bus.
- (c) Connect plotters/tablets to any **unused** bus addresses, as indicated. Do not connect plotters/tablets and printers on same bus, if possible.

## Installing Non-HP-IB Peripherals

This section explains how to connect your computer to terminals and other HP-UX computer systems. Guidelines for configuring terminals are also provided in this section. Before you attempt to make these connections, all interfaces must be installed in the computer.

### Datacomm Cables

Datacomm cables generally fall into one of three categories.

- DTE (Data Terminal Equipment) cables connect an RS-232C interface to other RS-232C devices. DTE cables are configured so that the terminal or computer connected to the cable behaves electrically like a terminal when connected to a mating cable or device. The Series 200 DTE cable is available as an option with the HP 98628 Datacomm Interface and HP 98626 Asynchronous Serial Interface, or it can be ordered separately (HP Part No. 5061-4215). The cable is fitted with a male RS-232C connector that mates directly with any RS-232C modem or with an RS-232C DCE cable or modem eliminator extension cable.
- DCE (Data Communication Equipment) cables, sometimes called modem eliminator cables contain internal cross-wiring to make the HP 98628 Datacomm Interface and HP 98626 Asynchronous Serial Interface electrically resemble a modem when connected to a DTE cable. This enables you to directly connect an HP-UX computer to a terminal (or computer equipped with terminal emulator software). The DCE cable is available as an option with the HP 98628 Datacomm Interface and HP 98626 Asynchronous Serial Interface, or it can be ordered separately (HP Part No. 5061-4216). The DCE cable cannot be used for direct connections between two HP-UX computers in a network.
- Extension cables are used in direct connections to lengthen the distance between the computer and a terminal, or between computers in a network. They are usually wired straight through such that each pin on one connector is connected to the mating pin on the connector at

the other end. However, some extension cables are wired as modem eliminator cables such that they can mate with a DTE cable at both ends. The modem eliminator cable is cross-wired to provide the necessary signal routing for proper link behavior.

Extension cables are terminated by a male and a female connector. Modem eliminator cables have female connectors at both ends.

## Connecting Terminals

Terminal connections are straight-forward. Whether you are connecting a relatively simple terminal with few enhancements or a large powerful computer running sophisticated terminal emulator software, you are concerned with essentially two types of connections:

### Direct Connections

When terminals are located near the computer, direct links can be used, subject to certain interface signal expectations. In most cases, a DCE cable is used with the computer interface for direct connections to terminals in the system. Here is a typical direct connection:

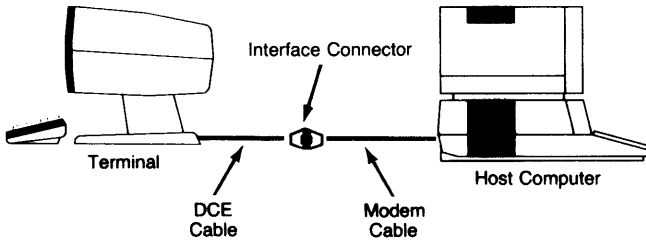

### Example of a Directly Connected Terminal

When connecting terminals to the HP-UX computer, the following guidelines are important. They apply equally to terminals and Series 200 computers running terminal emulator software.

- The terminal's modem cable must provide an RTS (request to send) signal to the datacomm or serial interface DCD (data carrier detect) input. The DCE cable connects RTS to the interface DCD (data carrier detect) input. This requirement is met when the modem cable supplied with the terminal is connected directly to the Series 200 DCE cable. If the combined length of the two cables is not sufficient to span the distance between the terminal and the computer, use an industry standard RS-232C extension cable that extends at least pins 1, 2, 3, 4,



7, and 8 pin-for-pin from the male connector at one end to the female connector at the other end. The DCE cable also returns the computer interface's RTS output to the terminal's modem cable DCD input.

---

#### Note

Always use industry standard cables or cables supplied with HP products for all system interconnection. If you need special adapters for specific needs, use a pair of connectors bolted together with cross-wiring readily accessible. This technique prevents confusion that can occur when troubleshooting a system that uses unmarked non-standard cables.

---

- You can also connect the terminal and computer using two DTE (modem) cables and an intermediate modem eliminator extension cable. The terminal's modem cable and the interface DTE cable are both equipped with male connectors having a DTE pin configuration. The modem eliminator cable provides the cross-wiring that makes each device look like a modem to the other device.
- For direct connections, set the **datacomm interface** hardware default switches to non-modem connection, hardware handshake off. If you are using a **serial interface**, set the modem line switches to their "always on" (not connected) positions.
- Connections to computers equipped with terminal emulator software are treated the same as terminal connections.

### Modem Connections

If you are using modems to connect terminals to your computer, both devices must be connected to a suitable modem. Be sure the two modems on each link are compatible with each other, have RS-232C interface connectors (unless the modem plugs directly onto the interface), and can support the required baud rate. Contact your HP Sales and Service Office if you need assistance in selecting modems. Connect the modem to the telephone line or other wire link, following the instructions in the modem installation manual. Connect the DTE modem cable between the datacomm or serial interface on your computer and the modem, then engage the retainers so the connectors cannot inadvertently come apart. Use the same technique to connect Series 200 Terminal Emulator computers to a modem. Install terminal modem cables as instructed in the terminal installation manual. The following illustration shows a modem connection between the computer and a terminal.

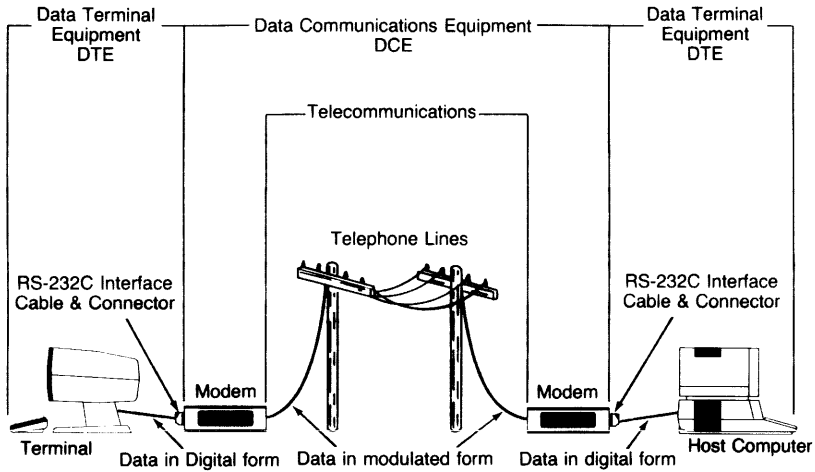

**Example of a Modem-connected Terminal**

Note that when using modem connections, hardware handshake must be active. Be sure that the serial interface modem line switches are in their “connected” (not “always on”) positions. The modem lines are used to control and verify the interaction between the computer and modem during message transfers. They are not directly related to the data being transferred. Data transfer handshaking between computers is handled as part of the data messages. The modem line switches are explained earlier in this chapter under “Installing Backplane Accessories”.

## Terminal Baud Rate Settings

Before a given terminal can communicate with the system computer, its baud rate must be configured to match system expectations. Baud rates are defined by the System Administrator at system configuration. Contact the System Administrator to determine the correct baud rate setting for the terminal being installed. Computer interface baud rate settings, except for the system console, are overridden by HP-UX, and are not important. Consult the terminal or terminal emulator manual for the required procedure when setting the terminal’s baud rate.

## Terminal Configuration

After terminals are installed, they must be correctly configured before they can successfully communicate with the HP-UX computer. Several parameters affect the terminal's interaction with the compute. They include, among other factors, baud rate, character format (bits per character, stop bits, and parity), and terminal pacing. Terminal settings must exactly match the configuration of the HP-UX operating system for each terminal being connected to the system.

Some user terminal configuration requirements are defined during HP-UX operating system installation or reconfiguration, while others are permanently defined by HP-UX. The following list shows the parameters that are permanently established by HP-UX. For other parameters (such as baud rate), contact the System Administrator for information about what configuration settings are appropriate for the terminal(s) being installed.

Two sets of parameters apply during configuration. The first set applies to the terminal directly, while the second set applies to the datacomm link. Some of the parameters listed here may not be configurable options on some supported terminal models. If that is the case for supported terminals in your installation, the unconfigurable parameters are handled correctly by the terminal. Configuration parameters that are available on your terminal, but not listed here are not of interest to HP-UX, so you can use any value that fits your needs.

Parameters are listed here. Refer to the terminal manual for the meaning of each parameter and how to set it up.

### Terminal Configuration Settings

Parameter	Setting
Tab = Spaces:	NO
RETURN Def:	Carriage Return (no line-feed)
RETURN = ENTER:	NO
LocalEcho:	OFF
CapsLock:	OFF
StartCol:	1
ASCII 8 Bits:	NO
XmitFunctn (Strap A):	NO
SPOW (Strap B):	NO
InhEolWrp (Strap C):	NO
InhHndShk (Strap G):	YES
InhDC2 (Strap H):	YES

## Datacomm Configuration Settings

Parameter	Setting
Parity:	EVEN
DataBits:	7
Clk:	INT
StopBits:	1
EnqAck:	NO
TR(CD):	HI
ChkParity:	NO
RecvPace:	Xon/Xoff
SRRXmit:	NO
RR(CF)Recv:	NO
XmitPace:	Xon/Xoff
SRRXmit:	NO
RR(CF)Recv:	NO
XmitPace:	Xon/Xoff
SRRInvert:	NO
CS(CB)Xmit:	NO

# Sales and Service

Appendix

**A**

## Peripherals and Accessories

HP provides a broad range of peripheral devices, interfaces, and accessories for your computer. Contact your HP Sales Representative for a complete and up-to-date listing.

To find your nearest HP dealer or sales office, call:

- In the U.S. (except Oregon, Alaska and Hawaii), (800) 547-3400
- In Oregon, Alaska and Hawaii, (503) 758-1010
- TTY users with hearing or speech impairments, (503) 758-5566

## Service Information

Several service contracts are also available. For information on support services, call toll-free (800) 835-HPHP. Professional service is available from numerous HP Field Repair Centers around the world, as listed here.

### UNITED STATES

#### California

Hewlett-Packard Co.  
5400 W. Rosecrans Avenue  
Lawndale, California 90260  
Phone: (213) 970-7500

Hewlett-Packard Co.  
3003 Scott Boulevard  
Santa Clara, California 95050  
Phone: (408) 988-7000

#### Georgia

Hewlett-Packard Co.  
450 Interstate N. Parkway  
Atlanta, Georgia 30339  
Phone: (404) 955-1500

#### Illinois

Hewlett-Packard Co.  
5201 Tollview Drive  
Rolling Meadows, Illinois 60008  
Phone: (321) 255-9800

#### New Jersey

Hewlett-Packard Co.  
W120 Century Road  
Paramus, New Jersey 07652

#### Texas

Hewlett-Packard Co.  
930 E. Campbell Road  
Richardson, Texas 75080

### CANADA

Hewlett-Packard Co.  
6877 Goreway Drive  
Mississauga, Ontario  
Canada, L4V1M8  
Phone: (416) 678-2530

### EUROPEAN LOCATIONS

Frankfurt, Germany  
Orsay, France  
Winnersh, United Kingdom  
Zurich, Switzerland  
Milan, Italy  
Brussels, Belgium  
Amsterdam, Holland  
Stockholm, Sweden  
Oslo, Norway  
Copenhagen, Denmark  
Madrid, Spain  
Vienna, Austria  
Helsinki, Finland

### ICON LOCATIONS

Buenos Aires, Argentina  
Victoria, Australia  
Wellington, New Zealand  
Tepepan, Xochimilco, Mexico  
Caracas, Venezuela  
Sandton, Transvaal, South Africa  
Singapore  
Tokyo, Japan

# Glossary

**Alpha Display:** The part of the screen defined by BASIC for displaying normal text characters (letters and numbers).

**Baud Rate:** The number of bits transmitted each second during a serial transmission.

**Binary Programs:** Programs written in machine language which extend the command set and capabilities of a language system.

**Bit:** A binary digit (1 or 0).

**Boot ROM:** The boot ROM stores instructions that tell the computer how to search for a system program. They basically keep the computer running until a system program can take over.

**Bus Address:** A number that identifies the location of a device on the HP-IB; also called primary address.

**Byte:** The unit of memory used on your computer. One byte equals eight bits.

**Character Code:** A numeric code which is used to represent a character inside the computer.

**Controller:** An device capable of regulating the communication among devices on the HP-IB.

**CRT:** The computer's screen (cathode ray tube).

**Cursor:** The blinking underline character that marks the position on the screen where the next character will be typed.

**Default Device:** If you execute an I/O operation (e.g. LOAD, PRINT) without specifying which device the operation refers to, the computer *assumes* you want to use the default device and carries out the command. When loading a program from the default disc drive, for example, you don't have to include the msus—the computer *assumes* the msus of the default drive.

**Disc:** Similar to a phonograph record, except that it stores programs and data instead of music.

**Disc Drive:** An input/output device that transfers programs and data between a disc and the computer's memory.

**Entree:** An item in a program menu.

**Graphics Display:** The part of the screen defined by a language system for drawing graphs, charts and other pictorial displays.

**Hardware:** All of the electrical and mechanical components of the computer.

**Human Interface:** The part of a program that handles all interaction between the computer and the person who operates it. A good human interface makes using the computer easy.

**Input/Output:** Anything relating to the exchange of information between the computer and its peripherals.

**Input Device:** A peripheral device which transfers programs and data into the computer. Common input devices include keyboards, disc drives and graphics tablets.

**Interface:** The interface makes the computer and a peripheral mechanically and electronically compatible. It is the "interpreter" of the system, making communication possible between the computer and its peripherals.

**K bytes:** 1 024 bytes.

**Language System:** A large program which performs all of the functions of a system program, plus supports a programming language like BASIC or Pascal.

**Language-dependent Program:** A program which requires a language system in order to run. Language-dependent programs are always loaded into memory *after* a language system has been booted.

**Listener:** Any peripheral device capable of *receiving* information on the HP-IB.



**Machine Language:** The language the computer's processor understands, expressed in terms of bits (1s and 0s).

**Mass Storage Device:** For most computer applications, a mass storage device is simply a disc drive.

**Mass Storage Unit Specifier:** A string of characters used to designate a particular disc drive (or other mass storage device). Abbreviated as msus.

**Memory:** The area of the computer where programs and data are stored. The processor cannot run a program unless it is in memory.

**Memory Address:** A number which uniquely identifies one byte of memory.

**Menu:** Usually, a list of things that a program can do. You control the progress of the program by selecting one of the menu's entrees.

**Modem:** A peripheral device that allows computer signals to be sent and received over telephone lines; used with the Data Communications interface.

**msus:** See Mass Storage Unit Specifier.

**Output Device:** A peripheral device which accepts information from the computer for storage or display purposes. Common output devices include computer screens, disc drives, printers and plotters.

**Parity Bit:** A bit that is appended to a character code for detecting errors during transmission.

**Peripheral Devices:** Devices that allow the computer to communicate with the outside world. See "Input Device" and "Output Device."

**Primary Address:** See Bus Address.

**Processor:** This is the "brain" of the computer that runs programs and regulates most other computer functions.

**Program:** A set of instructions that tell the processor how to perform a particular task. Most programs are written in a high-level programming language like BASIC or Pascal.

**Program Listing:** A list of all statements in a program.

**Prompt:** A message that a running program displays on the screen when it needs data or other information from you.

**RAM:** Random Access Memory. This is erasable program memory. Programs and data are usually copied into RAM from a disc drive or other mass storage device, executed by the processor, and then erased from RAM. When the power is turned off, RAM is erased.

**ROM:** Read-Only Memory. This is permanent program memory, used primarily for storing essential programs. Programs in ROM are never erased, so ROM is not reusable.

**Select Code:** A number which uniquely identifies an interface. The processor uses the select code to select which interface will be used in a data transfer operation.

**Serial Transmission:** Transmission of data one bit at a time over a single wire.

**Software:** A synonym for program.

**Start Bit:** A bit used to mark the beginning of a character in a serial transmission.

**Stop Bit:** A bit used to mark the end of a character in a serial transmission.

**System Program:** A program which handles all of the overhead functions of computing, such as defining the keyboard, managing the peripherals, refreshing the display, etc. When the computer is turned on and passes its self-test, it immediately begins searching for a system program to boot.

**Stand-alone Program:** A program that has a "built-in" system program and can run without any underlying language support.

**Talker:** Any peripheral device capable of *sending* information over the HP-IB.

# Subject Index

## a

Accessories, backplane	
installation	6,15
list	16.1
Accessory card cage	6,21
Address	
HP-IB	32,33,34
memory	18,23,24,24.1,24.2
Adjustment, brightness	13
Air flow	8
Assignments, select code	20,24.6

## b

Backplane accessories	15,17
Baud rate	41,66,67
Beeper, boot ROM	49
Boot ROM	
beeper	49
errors	50
general	4,14,48,49,50
Booting	4,6
Brightness adjustment	13
Brightness knob	6
Built-in HP-IB	
HP-UX	61
non-HP-UX	19,20
Bus	
addressing, HP-IB	33,34
external HP-IB	33
HP-IB	30,31,32
HP-IB for HP-UX	61,62
internal HP-IB	33
System HP-IB	33
Byte	17

# C

Cable	
data communications	42,43,44,45,63,64,65,66
display	9,10
HP-IB	34,35
power	12
Cage, accessory card	6,21
Card cage, accessory	6,21
Chapter contents	2
Clearance, computer	8
Code, select	20,25
Color display	10,11,12,13
Communications, data	38,63
Computer installation	7,8
Computer Supplies Operation	34
Configuration switches, memory	24,24.1,24.2,24.3
Connecting power cords	12
Connectors, data communications	42,43,44,45,63,64,65,66
Cooling fan	6,13
Cords, power	12
Covers, accessory card cage	21
CRT	
color	12,13
definition	4
switches	10
CS/80 disc drives	61,62
CSO	34

# d

Data communications (Datacomm)	38,42,43,44,45,63,64,65,66
Data terminal equipment	38,63,64,65,66
DCE	38,42,43,44,45,63,64,65,66
Devices	
input	4
output	4
peripheral	4
Disc drive	4,11,27
Disc drives, CS/80	61,62

Display	
cable	9
color	10,11,12,13
installation	9
power-up	13
switches	10
Drive, disc	4,11,27
DTE	38,42,43,44,45,63,64,65,66

## e

Electrostatic discharge	15,23,24.6
Emulator, terminal	45,63,64,65,66
Error messages, boot ROM	48,49,52,53
Errors	51
Errors, boot ROM	50
Even parity	42

## f

Fan	6,13
Fuse installation	11
Fuses	6,11

## g

Graphics devices	28
Guide organization	2

## h

Handling backplane accessories	15,23,24.6
HP 82901 Disc Drive	62
HP 82902 Disc Drive	62
HP 9135 Disc Drive	62

HP 98256A RAM card . . . . .	18,23,24,24.1,24.2,24.3
HP 98257A RAM Card . . . . .	23,24.1,24.2,24.3
HP 98620B DMA Controller . . . . .	23,55,56
HP 98624A HP-IB Interface . . . . .	16.1,25,33,57,61,62
HP 98625A High-speed Disc Interface . . . . .	16.1,25,33,45,56,61
HP 98626A Asynchronous Serial Interface . . . . .	16.1,25,38,58,59,63
HP 98628A Datacomm Interface . . . . .	16.1,25,38,58,59,60,63
HP 98691A Programmable Datacomm Interface . . . . .	16.1,38
HP 9888A Backplane Expander . . . . .	16.1,19,22,26
HP-IB	
bus address . . . . .	32,33
buses for HP-UX . . . . .	61,62,63
cables . . . . .	34,35
interface . . . . .	6,19,20,27,29
peripheral devices . . . . .	27,32,33,34
system controller . . . . .	30,31,32
HP-UX	
general . . . . .	2,7,15,23,24.6,31,33,37,55-68
hardware . . . . .	55
HP-IB buses . . . . .	61,62,63
select codes . . . . .	58

## i

Input devices . . . . .	4
Installation	
backplane accessories . . . . .	15
computer . . . . .	7
display . . . . .	9
display cable . . . . .	9
fuse . . . . .	11
power cords . . . . .	12
Instruments . . . . .	28
Interface	
concepts . . . . .	19
data communications . . . . .	38
HP-IB . . . . .	6,19,20,27,29,30
peripheral . . . . .	5
Internal HP-IB bus for HP-UX . . . . .	61,62

**j**

Jumper, HP-IB system controller . . . . . 31

**k**

K bytes . . . . . 17  
 Knob, brightness . . . . . 6,13

**l**

Line-voltage switches . . . . . 10

**m**

M bytes . . . . . 18  
 Memory  
   address . . . . . 18,23,24  
   card switches . . . . . 18,19,23,24  
   extended test . . . . . 50  
   random access . . . . . 3  
   read-only . . . . . 3  
 Messages  
   boot ROM error . . . . . 48,49,52,53  
   self-test . . . . . 6,47  
   status . . . . . 48  
 Modem . . . . . 38,43,63,64,65,66

**O**

Odd parity . . . . . 42  
 Operating system . . . . . 14  
 Organization, guide . . . . . 2  
 Output devices . . . . . 4

# p

Parallel transmission . . . . .	39
Parity . . . . .	41,42,67,68
Peripheral, devices	
definition . . . . .	4
HP-IB . . . . .	32,33,34
non-HP-IB . . . . .	37,63
Peripheral interface . . . . .	5
Plotters . . . . .	28
Position, computer . . . . .	8
Power	
cables . . . . .	12
cords . . . . .	12
sockets . . . . .	6
switch . . . . .	6
Power-up	
display . . . . .	13
self-tests . . . . .	14
Precautions, handling . . . . .	15,23,25
Printers . . . . .	28
Processor . . . . .	3
Program . . . . .	3
Program, booting . . . . .	4

# r

RAM . . . . .	3,4,18,48
RAM card . . . . .	18,23,24
Random access memory . . . . .	3,18
Read-only memory . . . . .	3
ROM . . . . .	3,4,14
ROM, boot . . . . .	4,48,49,50
Root device . . . . .	61
RS-232C . . . . .	38,63,64,65,66
RS-232C peripherals . . . . .	44,45,63,64,65,66



# S

Sales assistance .....	69
Screen, video .....	4
Select code .....	19,20,24.6,25
Select codes, HP-UX .....	58
Self-test messages .....	6,47
Self-tests .....	14
Serial transmission .....	40
Service information .....	70
Settings	
brightness .....	6
HP-IB address switches .....	32,33,34
interface card switches .....	26
line-voltage switches .....	10
RAM card switches .....	18,23,24,24.1,24.2,24.3
select codes .....	19,20,24.6,25
Shipping inserts, disc drive .....	11
Slots, accessory card cage .....	21,22
Sockets, power .....	6
Software .....	3
Start bit .....	41
Status messages .....	48
Stop bit .....	41,67,68
Switch, power .....	6
Switches	
HP-IB device address .....	32,33,34
interface card .....	26
line-voltage .....	10
RAM card .....	18,23,24,24.1,24.2,24.3
select code .....	20,24.6,25
voltage .....	6
System administrator .....	66,67
System controller jumper .....	31

## t

Tape drives .....	27
Terminal emulator .....	45,63,64,65,66
Terminals .....	44,45,63,64,65,66,67,68
Test, extended memory .....	50
Transmission	
parallel .....	39
serial .....	40

## v

Ventilation, computer .....	8
Verification	
interfaces .....	25
memory .....	24.5
Video screen .....	4
Voltage switches .....	6,10

