

HP Series 200 Computers



# Models 26 and 36 CE Handbook



Part No. 09826-90039  
E0738  
Requires Binder No. 9282-0683

Printed in U.S.A.  
Third Edition, July 1983

# Models 26 and 36 CE Handbook

© Copyright Hewlett-Packard Company, 1981, 1982, 1983

This document refers to proprietary computer software which is protected by copyright. All rights are reserved. Copying or other reproduction of this program except for archival purposes is prohibited without the prior written consent of Hewlett-Packard Company.

**Hewlett-Packard Company**  
3404 East Harmony Road, Fort Collins, Colorado 80525

**Chapter 1**  
**9826/9836 Product Information**

**Chapter 2**  
**9826/9836 Environmental/Installation/PM**

**Chapter 3**  
**9826/9836 Configuration**

**Chapter 4**  
**9826/9836 Troubleshooting**

**Chapter 5**  
**9826/9836 Diagnostics**

**Chapter 6**  
**9826/9836 Adjustments**

**Chapter 7**  
**9826/9836 Peripherals**

**Chapter 8**  
**9826/9836 Replaceable Parts**

**Chapter 9**  
**9826/9836 Diagrams**

**Chapter 10**  
**9826/9836 Reference**

**Chapter 11**  
**9826/9836 Service Notes**

# Chapter 1

## 9826/9836 Product Information

### Features

- Seven levels of prioritized interrupt
- Multilanguage capability (BASIC, HPL, Pascal)
- Memory-mapped I/O
- Built-in HP-IB interface
- Seven additional interface cards
- Standard ASCII keyboard with numeric keypad and international language options
- Ten (20 with shift) user-definable soft keys with soft labels
- Rotary-control knob for cursor control, interrupt generation and analog simulations
- System clock and three timers
- Powerfail recovery option for protection against power lapses

### Processor

Type:	Motorola MC68000
Clock frequency:	8 MHz
Internal architecture:	32-bit data and address registers
Address range:	16M bytes
Data bus:	16-bit asynchronous
Instruction types:	56
Major data types:	5
Addressing modes:	14
Interrupt levels:	One non-maskable and 6 maskable

### Rotary Control Knob

Pulse resolution:	120 pulses per revolution (nominal)
Pulse count range:	-128 to 127 net pulses since last interrupt
Pulse count sign:	
Positive:	Net clockwise
Negative:	Net counterclockwise
Interrupt generation:	
Period:	.01 sec to 2.55 sec

### Model 26/36/36C Integrated Flexible Disc Mass Storage

Drives in computer:

Tracks per disc:  
User available tracks:  
Sectors per track:  
Bytes per sector:  
Total capacity:  
File name size:  
Rotational speed:  
Average access time:  
Average transfer rate:

Model 26 - one  
Model 36 - two  
35 per side, 70 total  
66  
16  
256  
264K bytes  
Up to 10 characters  
300 RPM  
300 msec  
16K bytes/s, default interleave, track to track stagger  
133 mm (5¼-in.) double-sided, double-density flexible disc  
More than 2.5 million revolutions (140 hours rotating)<sup>1</sup>

Media:

Life:

### Clock and Timers

Real-time clock	
Resolution:	10 msec
Accuracy:	50 ppm (4.3 sec./day)
Power-on reset:	Midnight, January 1
Timers	
Match interrupt:	Match on time of day, 0.00 to 84600.00 seconds
Delay interrupt:	10 msec to 1.94 days
Cycled interrupt:	10 msec to 1.94 days

### Beeper

Range (nominal):	81.375 Hz to 5208 Hz
Resolution:	81.375 Hz nominal
Duration:	.01 sec to 2.55 sec

**CRT Display**

	<b>Model 26</b>	<b>Model 36</b>	<b>Model 36C</b>
Size:	178 mm (7 in.) diagonal	310 mm (12.2 in.) diagonal	310 mm (12 in.) diagonal
Alphanumeric capacity On screen: Total scrolling:	25 lines x 50 characters 39 lines x 50 characters, 1 950 characters	25 lines x 80 characters 39 lines x 80 characters, 3 120 characters	25 lines x 80 characters 39 lines x 80 characters, 3 120 characters
Character height:	1.51 mm wide x 2.12 mm high (.059 in. x .082 in.) capital letters	1.9 mm wide x 3.8 mm high (.07 in. x .15 in.) capital letters	1.9 mm wide x 3.9 mm high (.08 in. x .16 in.) capital letters
Display enhancements:	None	Inverse video, underlining, blinking, half bright	Inverse video, underlining, blinking, eight alpha colors
Graphics capability Resolution:	400 dots horizontal x 300 dots vertical	512 dots horizontal x 390 dots vertical	512 dots horizontal x 390 dots vertical x 4 bits/pixel
Density:	33 dots/cm (85 dots/in.)	24 dots/cm (60 dots/in.)	24 dots/cm (60 dots/in.)
Raster size:	120 mm x 88 mm (4.7 in. x 3.47 in.)	210 mm x 160 mm (8.3 in. x 6.3 in.)	217 mm x 163 mm (8.5 in. x 6.4 in.)
Display buffering:	Dedicated 1.25K byte alpha buffer, 15K byte graphics buffer (can be displayed simultaneously)	Dedicated 4K byte alpha buffer, 25K byte graphics buffer (can be displayed simultaneously)	Dedicated 4K byte alpha buffer, 100K byte graphics buffer (can be displayed simultaneously)
Soft-key labeling:	Up to 10 user-definable soft-key labels, 8 characters per label	Up to 10 user-definable soft-key labels, 14 characters per label	Up to 10 user-definable soft-key labels, 14 characters per label
Character set:	256 characters	256 characters	256 characters
Character font:	5 x 7 dot character matrix in a 8 x 12 character cell	7 x 9 dot character matrix in a 9 x 15 character cell	7 x 9 dot character matrix in a 9 x 15 character cell
Intensity:	Adjustable up to 30 ft-lamberts	Adjustable up to 15 ft-lamberts (12 ft-lamberts Opt. 801)	Adjustable up to 18 ft-lamberts (15 ft-lamberts Opt. 801)
Refresh rate:	60 Hz independent of line frequency	60 Hz standard (50 Hz Opt. 801) independent of line frequency	60 Hz standard (50 Hz Opt. 801) independent of line frequency
Implosion protection:	Lexan plastic shield	Tension band and safety glass	Tension band and safety glass
Tube phosphor:	P4	P4	P22
Cursor:	Blinking underline	Blinking underline	Blinking underline

# Interface Information

## GPIO interface

The 98622A GPIO Interface provides 16 bits of latched input and output data for bidirectional transfer of information. Extended control and status lines are available for applications that require more than one signal from the computer. Several handshake modes are also available to permit interfacing to a variety of equipment.

## BCD Interface

The 98623A BCD Interface connects the 9826 or 9836 with bit-parallel, digit-parallel, binary-coded-decimal devices for data input. Up to eight significant BCD digits, two sign bits (mantissa and exponent), exponent digit, function code digit, and an overload bit can be read. Input format is selectable, allowing two independent instruments to be read from one 98623A Interface Card. Data can also be accepted as five input bytes of pure binary information. Eight data output lines are also provided for use as general purpose control and/or data output.

## HP-IB Interface

In addition to the standard, built-in HP-IB interface, there is an optional external 98624A HP-IB Interface Card. Both interfaces implement the IEEE 488-1978 Standard Digital Interface for Programmable Instrumentation. Both interfaces can communicate with as many as 14 HP-IB compatible instruments, connected with a maximum of 20 meters (65.6 ft.) of cable.

## Serial Interface

The 98626A Serial Interface provides bit-serial communication between the 9826 or 9836 and asynchronous EIA RS-232-C (CCITT V.28/V.24) devices such as data terminals and modems. Data rates range from 50 to 19 200 baud (bits/sec). A variety of cabling options allow for current loop, modem and terminal connections.

## Data Communications Interface

The 98628A Data Communications Interface provides both protocol management and electrical levels for asynchronous serial communications. This card also supports the Data System Network Data Link (DSN/DL) protocol for communications to an HP 1000 or HP 3000 series minicomputer. A terminal emulation program will be available at a later date that takes advantage of this card for communication to other computers.

## DMA Controller Card

The 98620A DMA Controller Card enhances the 9826/9836's interfacing capability by providing two DMA channels for I/O data transfers. This high-speed I/O capability works with the 98622A GPIO, 98624A HP-IB and internal HP-IB interfaces. Although the 98620A can accommodate DMA transfer rates up to memory cycle rates (approx. 1.2M transfers/sec.) lower DMA rates can be expected since actual rates are dependent on a number of factors. The typical transfer rate for the 98622A GPIO Interface is approximately 750K transfers per second, and for the 98624A HP-IB Interface approximately 330K transfers per second.

## Color Video Interface

The 98627A Color Video Interface provides the interconnection to an external color monitor. This interface connects to a high-performance, high-resolution color monitor via three outputs - Red, Green/sync and Blue (RGB). The capabilities provided by this interface make it appear as a "soft plotter".

# Configuration Information

## How

1. Determine which language system you want with your 9826 or 9836 and select the appropriate option.
2. Pick a 98261A add-on language system if you desire a second language. (Refer to TABLES A and B to determine if you have enough memory to operate this system.)
3. Select any I/O cards desired (see TABLE C).
4. Add any additional memory desired (see TABLE D regarding memory limitations - the eight slots in the card cage must accommodate the I/O, RAM, ROM or DMA controller options).

## Example

You need a 9836 with a ROM BASIC system and a RAM Pascal system. You also need a 16-bit parallel card with unterminated cable, a DMA controller, a hard disc card and a Datacomm card with a DTE cable. Finally, you want the maximum memory allowable with the given interfaces. To get this system, order:

9836A*	Opt. 715 (Pascal Language System)
98261A	Opt. 011 (BASIC ROM System)
98622A	Opt. 001 (16-bit interface with cable)
98620A	(DMA Controller)
98625A	(Hard Disc Interface)
98628A	Opt. 001 (Datacomm Interface with Cable)
98256A	(Two) Add-on Memory**

\* The same ordering information also applies to the 9826A.

\*\* The items listed consume six of the eight slots, leaving room for two additional memory cards. Since Opt. 715 already provides two 256K-byte RAM cards, the two additional cards bring total memory to over 576K bytes.

# Configuration Tables

## A. Computer/Language Options

### Mainframes

Computer/Product No.	Standard RAM	Backplane Slots Available	Max. I/O
<b>Model 26A Computer</b> 9826A • Built-in HP-IB (w/2-meter cable) • 8-slot card cage for interfaces, language systems and memory expansion • 7-in. diagonal CRT (50 characters wide) • Powerfail support available • Boots from all supported mass storage devices, including SRM	128K bytes*	8	4
<b>Model 26S Computer</b> 9826S • RAM BASIC 2.0 • BASIC Extensions 2.1 • RAM Pascal 2.1 • 640K byte RAM (128K on processor board plus two additional 256K boards) • Built-in HP-IB (w/2-meter cable) • 8-slot card cage for interfaces, language systems and memory expansion • 7-in. diagonal CRT (50 characters wide) • Powerfail support available • Boots from all supported mass storage devices, including SRM	640K bytes	6	4
<b>Model 36A Computer</b> 9836A • Built-in HP-IB (w/2-meter cable) • 8-slot card cage for interfaces, language systems and memory expansion • 12-in. diagonal CRT (80 characters wide) • Powerfail support available • Boots from all supported mass storage devices, including SRM	128K bytes*	8	4
<b>Model 36S Computer</b> 9836S • RAM BASIC 2.0 • BASIC Extensions 2.1 • RAM Pascal 2.1 • 640K byte RAM (128K on processor board plus two additional 256K boards) • Built-in HP-IB (w/2-meter cable) • 8-slot card cage for interfaces, language systems and memory expansion • 12-in. diagonal CRT (80 characters wide) • Powerfail support available • Boots from all supported mass storage devices, including SRM	640K bytes	6	4
<b>Model 36C Color Computer</b> 9836C • Built-in HP-IB (w/2-meter cable) • 8-slot card cage for interfaces, language systems and memory expansion • 12-in. diagonal CRT (80 characters wide) • Powerfail support available <sup>†</sup> • Boots from all supported mass storage devices, including SRM	128K bytes*	8	4
<b>Model 36CS</b> 9836CS • RAM BASIC 2.0 • BASIC Extensions 2.1 • RAM Pascal 2.1 • 640K byte RAM (128K on processor board plus two additional 256K boards) • Built-in HP-IB (w/2-meter cable) • 8-slot card cage for interfaces, language systems and memory expansion • 12-in. diagonal CRT (80 characters wide) • Powerfail support available <sup>†</sup> • Boots from all supported mass storage devices, including SRM	640K bytes	6	4

\* On the processor board.

† Powerfail on the Model 36C retains all information, but the display cannot be powered.

### Mainframe Options

Computer	Opt. No.	Description
Model 26A 26S 36A 36S 36C 36CS	050	Powerfail protection
Model 36A 36S 36C 36CS	801	Jumper for 50 Hz refresh rate on CRT
All Models	810	French keyboard/character set
	820	Spanish keyboard/character set
	830	German keyboard/character set
	840	Katakana keyboard/character set
	850	Swedish/Finnish keyboard/character set

## B. Add-on Language Systems

### Languages

Product No.	Description	Approximate Read/Write Memory Required by Language System
98601A	BASIC 2.0	
98611A	ROM	21K
98611R	RAM	277K
	Right-to-Reproduce*	277K
98612A	BASIC Extensions 2.1†	
98612R	RAM	328K
	Right-to-Reproduce*	328K
98604A	HPL 2.0‡	
98614A	ROM	14K
98614R	RAM	122K
	Right-to-Reproduce*	122K
98615A	Pascal 2.1	
98615R	RAM	512K†
	Right-to-Reproduce**	512K†
98615E	Right-to-Execute**	130K††

\* Confers the right to make one additional copy of the language for use on another computer. A certificate and manual are supplied.

† Requires BASIC 2.0 to run. BASIC Extensions 2.1 consists of six separate modules. The following amount of memory is required by the individual modules:

Advanced Programming	176K
Graphics	48K
Shared Resource Management	53K
Shared Resource Management Programming	35K
HP-IL/BCD	12K
XREF	7K

‡ HPL is not supported on the Models 36C or 36CS.

\*\* Confers the right to duplicate only the operating system for the purpose of executing application software. None of the program development subsystems (editor, compiler, etc.) may be reproduced. A certificate is supplied, but no manuals.

†† Minimum recommended execution environment.

### Language Systems

HP Part No.	Description
98261-66511	BASIC 1.0 (ROM), Board 1
98261-66512	BASIC 1.0 (ROM), Board 2
98261-66513	BASIC 2.0 (ROM) 98601A
98261-66514	BASIC 2.1 (ROM) 98602A
98261-66541	HPL 1.0 (ROM)
98261-66542	HPL 2.0 (ROM)
98611-10x04	BASIC 2.0 (Disc) 98611A
98612-11x24	BASIC Extensions (AP2.1, Graphics 2.1) (Disc) 98612A
09800-11x24	BASIC Extensions (SRM 2.1) (Disc) 98612A
98614-10x04	HPL 2.0 (Disc) 98614A
09800-10x59	HPL 2.0 (Disc) (Utilities) 98614A
98615-11354	Pascal 2.1 Boot (Disc) 98615A
98615-11355	Pascal 2.1 SYSVOL (Disc) 98615A
98615-11356	Pascal 2.1 ACCESS (Disc) 98615A
98615-11357	Pascal 2.1 CMPASM (Disc) 98615A
98615-11358	Pascal 2.1 LIB (Disc) 98615A
98615-11364	Pascal 2.1 CONFIG (Disc) 98615A

X refers to disc size: 3 for use in 3½ in. drives  
 5 for use in 5¼ in. external drives  
 6 for use in 5¼ in. internal drives



Language System Updates

HP Part No.	Description	Notes
98261-69613	BASIC 1.0 to 2.0	ROM to ROM Return replaced boards
98261-69114	BASIC 1.0 to 2.0	ROM or disc to disc Return replaced boards or discs
98261-69144	HPL 1.0 to 2.0	ROM or disc to disc Return replaced board or disc
98261-69642	HPL 1.0 to 2.0	ROM to ROM Return replaced boards
98602-696X0	BASIC 2.0 to 2.1	ROM to ROM Return replaced board
98612-17x10	BASIC 2.0 to 2.1	Disc to disc

X refers to disc size: 3 for use in 3½ in. drives  
 5 for use in 5¼ in. external drives  
 6 for use in 5¼ in. internal drives

C. Add-on Interfaces/Cables

Series 200 Interfaces\*

Product No.	Description	Language Support		
		BASIC	HPL	Pascal
98624A	HP-IB <sup>1</sup>	1.0	1.0	1.0
98622A	GPIO	1.0	1.0	1.0
98623A	BCD	2.0 <sup>2</sup>	1.0	—
98626A	RS-232 (Serial)	1.0	1.0	2.0
98625A	Disc	—	—	2.0
98627A	Color Video	2.0 <sup>3</sup>	2.0	1.0
98634A	HP-IL	2.0 <sup>2</sup>	—	—
98628A <sup>4</sup>	Datacomm	1.0 <sup>5</sup>	—	1.0
98691A <sup>6</sup>	Programmable Datacomm	2.0 <sup>7</sup>	—	1.0 <sup>7</sup>

\* Excludes the interface for Shared Resource Management (SRM), which is not covered in this publication.

<sup>2</sup> Requires BASIC 2.0 plus BASIC Extensions 2.1. In this case, the HP-IL/BCD binary is used, requiring 12K of RAM in addition to the requirements of the language system.

<sup>3</sup> Requires BASIC 2.0 plus BASIC Extensions 2.1.

<sup>4</sup> The 98628A Datacomm Interface requires a personality module option. (This is not necessary for the Programmable Datacomm Interface.) The only option available at this time is Opt. 100. Please enter this number with each Datacomm Interface ordered.

<sup>5</sup> Requires the BASIC Enhancements Binary (BEB) if BASIC 1.0 is used. It is not recommended that BEB be sold, even to BASIC 1.0 customers, as all its capabilities are contained in BASIC 2.0 and it is no longer a supported product.

<sup>6</sup> The Programmable Datacomm Interface is not legal for connection to public lines, but requires a dedicated (i.e., private) line.

<sup>7</sup> Or user-written driver.

Series 200 Backplane Accessories

Product No.	Description	Language Support		
		BASIC	HPL	Pascal
98620A	DMA Controller (2-channel)	2.0*	1.0	1.0
98630A Opt. 001	Breadboard Card Backplane Extender Card	—	—	—
98255A	EPROM Card	2.0*	—	—
98253A	EPROM Development Kit (2 cards)	2.0*	—	—
98259A	128K Byte Magnetic Bubble Memory Card	2.0*	—	—

\* Requires BASIC 2.0 plus BASIC Extensions 2.1. In this case, the Advanced Programming Binary of BASIC Extensions 2.1 is used, requiring 176K of RAM in addition to the requirements of the language system.

D. Memory Matrix

Use Product number 98256A to order add-on memory (256K board). Note that the card cage has eight slots shared by interface cards (up to four), System ROMs, and RAM memory. Thus the I/O configuration and the language system influence user memory size, as indicated below.

I/O Cards Configured	ROM Systems (Approx. Max. User Memory)		RAM Systems (Approx. Max. User Memory)		
	BASIC (One Slot)	HPL - 9826/9836 (One Slot)	BASIC (One Slot)	HPL - 9826/9836 (One Slot)	Pascal* (Two Slots)
0	1877K	1889K/1879K	1877K	2040K/2030K	1792K
1	1615K	1627K/1617K	1615K	1778K/1768K	1536K
2	1353K	1365K/1355K	1353K	1516K/1506K	1280K
3	1091K	1103K/1093K	1091K	1254K/1244K	1024K
4	828K	841K/831K	828K	992K/982K	768K

\* The amount of actual user read/write memory varies in Pascal, depending on specific operating conditions in the subsystem being run.

## User Documentation

### BASIC Language Manuals

- 98612-87902 BASIC 2.0 (with extensions) Manual Kit  
 includes:  
 09826-90011 Programming Techniques  
 09826-90025 Interfacing Techniques  
 09826-90050 Condensed Reference  
 09826-90056 Language Reference

### HPL Manuals

- 09826-87903 HPL Manual Kit  
 includes:  
 09825-90022 Matrix Programming Manual  
 09825-90060 Interfacing Concepts  
 09825-90200 Operating and Programming Reference  
 09825-90210 I/O Control Reference  
 09825-90220 Disc Programming Manual  
 09826-90040 Operating Manual  
 09826-90045 Quick Reference

### Pascal Manuals

- 98615-87904 Pascal 1.0 Manual Kit  
 includes:  
 09826-90070 1.0 Language System User's Manual  
 09826-90071 Language Reference  
 09826-90072 Programming Text  
 09826-90073 MC68000 User's Manual  
 09826-90075 Procedure Library User's Manual
- 98615-87901 Pascal 2.0 Manual Kit  
 includes:  
 09826-90071 Language Reference  
 09826-90072 Programming Text  
 09826-90073 MC68000 User's Manual  
 09826-90075 Procedure Library User's Manual  
 98615-90020 2.0 User's Manual  
 98615-90090 2.1 Manual Update Kit

## Service Documentation

- 09836-90030 26/36A/36C Service Manual  
 09130-90030 Disc Drive Service Manual

### Interface Installation Manuals

- 98620-90000 98620A DMA Interface Manual  
 98622-90000 98622A GPIO Interface Manual  
 98623-90000 98623A BCD Interface Manual  
 98624-90000 98624A HP-IB Interface Manual  
 98625-90000 98625A Disc Interface Manual  
 98626-90000 98626A RS-232 Interface Manual  
 98627-90000 98627A Color Interface Manual  
 98628-90000 98628A Datacomm Interface Manual  
 98028-90000 Shared Resource Management Interface Manual (available June, 1982)

## Accessory Installation

98201-90000	98201A Keypad Interface Note
98203-90000	98203 Keyboard Note
98204-90000	98204A Video Interface Note
98253-90000	98253A EPROM Note
98256-90000	256k RAM Note
98259-90000	98259A Bubble Memory Note
98270-90000	Powerfail Manual
98630-90000	98630A Breadboard Manual
98634-90000	98634A HP-IL Note
09888-90000	9888 Expander Manual

## Tools List

HP Part No.	Description
8710-0004	Longnose Pliers
8710-0900	#2 Pozidriv (short blade)
8710-0948	#2 Pozidriv (long blade)
8710-0675	CRT Alignment Tool
8710-0797	9/32" Nutdriver (7.13 mm)
8710-0860	#2 Phillips Screwdriver
5040-7433	Key Cap Puller

# 9826 Exploded View

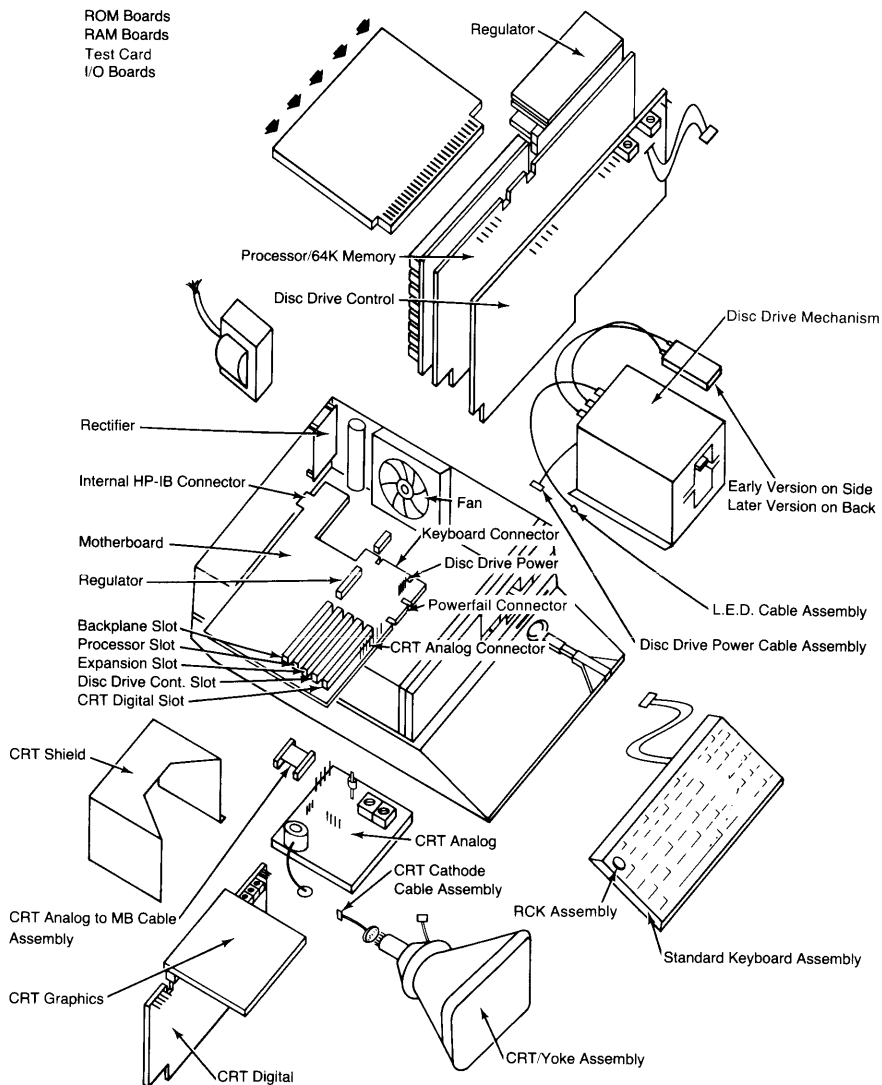

# 9836A Exploded View

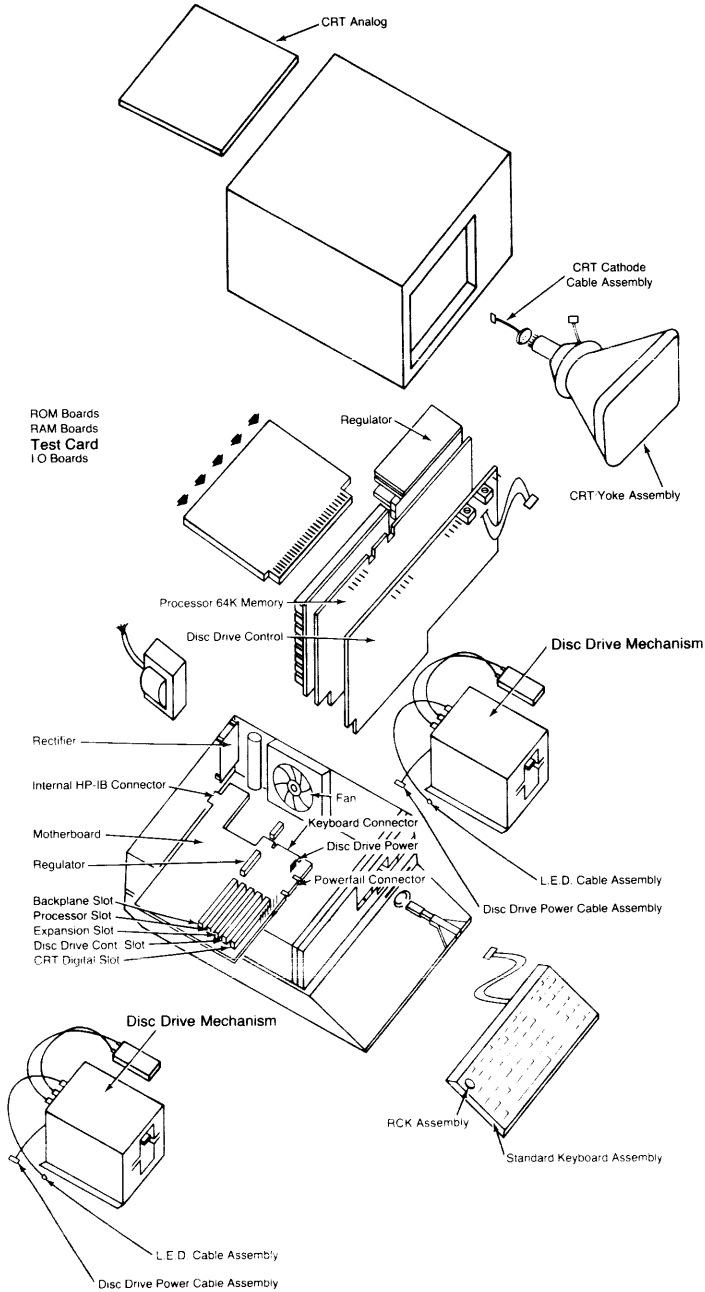

# 9836C Exploded View

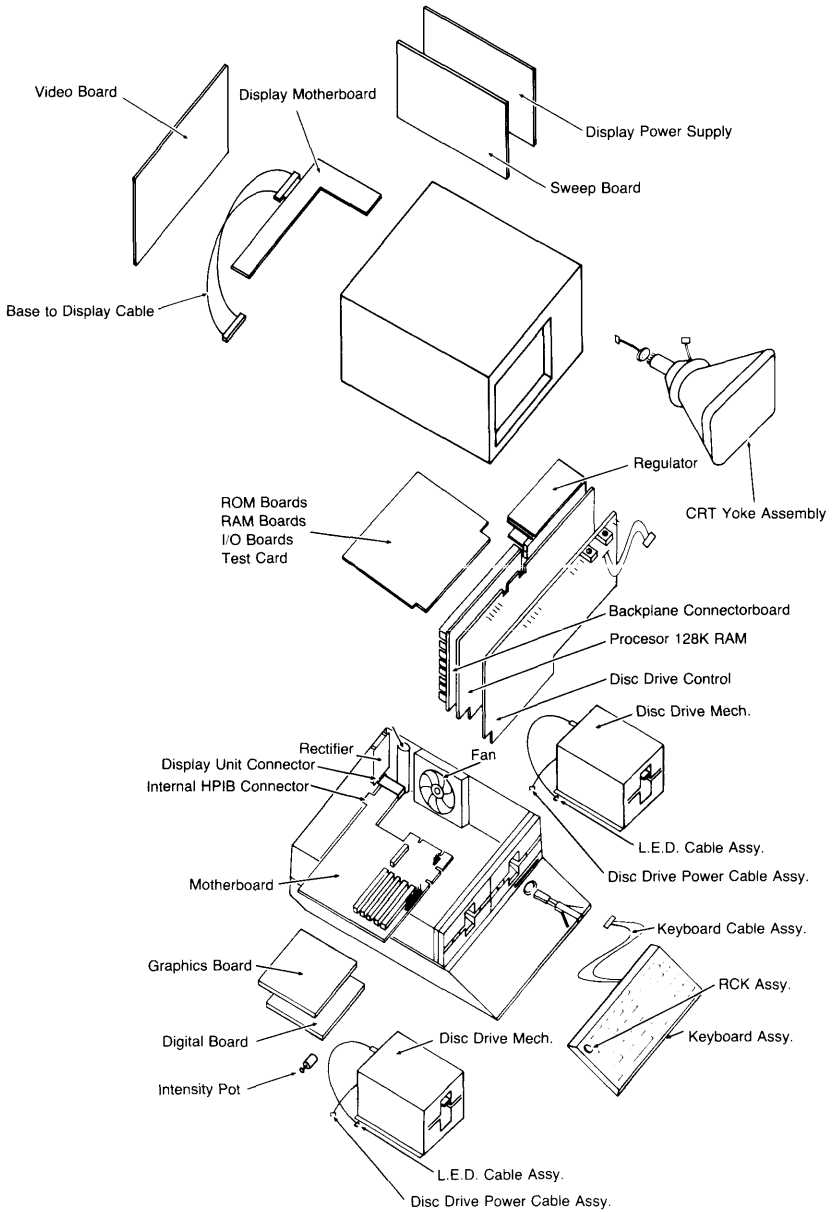

## Address Information

### Nice to Know Memory Addresses

Hex Address	Description
000000	Boot ROM
428000 to 42FFFF	Keyboard
428001	Keyboard Controller 8041 data
428003	Keyboard Controller 8041 status/control
440000 to 44FFFF	Disc Drive
44C000	Status and Command
44C002	Track Register
44C004	Sector Register
44C006	Data Register
44D000	Extended Command and Status
44E000	Disc RAM (256 bytes, even addresses)
478000 to 47FFFF	Internal HP-IB
500000 to 50FFFF	DMA Card
510001	CRT Controller
510003	CRT Controller
512001 to 512FFF	CRT Alpha Memory
512001	Begin Softkeys
512705 (in op system)	Upper Left Corner
512FFF (in op system)	Lower Right Corner not in Softkeys
530001 to 537FFF	CRT Graphics Screen On
538001 to 53FFFF	CRT Graphics Screen Off
530001	Upper Left Byte
810000 to 813FFF	Test Stimulus Board ROM
814000 to 817FFF	Test ROM Extensions (unused)
818000 to 8187FF	Test Stimulus Board RAM
81FFFE (word)	Test Stimulus Board LED and Switches

#### I/O Board Register Addresses

Register Address = 600000 + (Select Code\*100000) + Register Number

#### DMA Board Register Addresses

Channel 0 Register Address = 500000 + Register Number

Channel 1 Register Address = 500008 + Register Number

To enter test ROM from operating system:

BASIC: WRITEIO 9827, 8470504:1

HPL: peek ("813FE8",3)→A

PASCAL: Enter debugger  
G 813FE8

# Address Information

## Memory-Mapped I/O

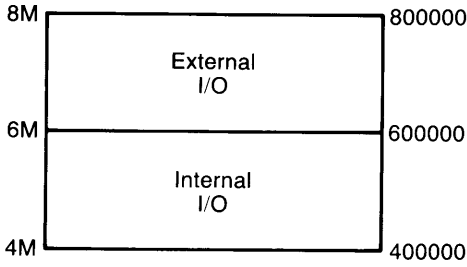

External Address Format:

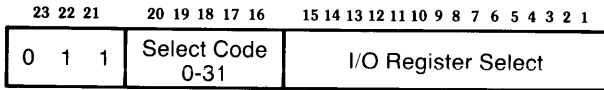

### Standard Select Codes

Internal	External	
0 Not Used	8 HPIB	20 Data Comm
1 CRT Alpha	9 RS232	.
2 KYBD & CLK	10	.
3 Graphics	11 BCD	.
4 Flex-Disc	12 GPIO	.
5	13	.
6 DMA	14 Disc Intrfc.	.
7 HPIB	.	.



# Address Information

## 9826/9836 Memory Map

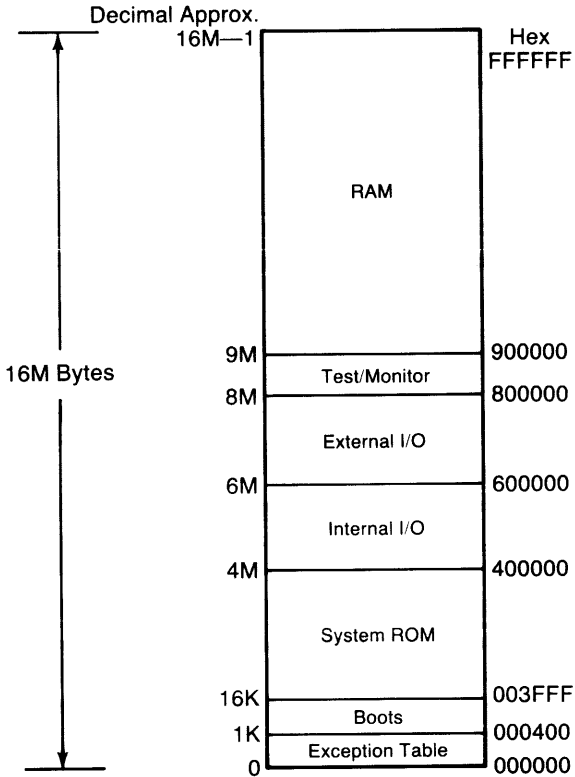

# Chapter 2

## 9826/9836 Environmental/ Installation/PM

In the material in this Chapter, the term 9826A refers to both the 9826A and the 9836 unless specific 9836 information is presented.

All values stated here are typical values for a 9826A desktop computer with interface cards, except where noted. These values are not meant as specifications and do not represent final approved values. Actual values will vary with individual machines. The 9826A Technical Data sheet is the only official specification of expected performance. This document is company confidential and should never be used to state guaranteed or contracted performance.

NO WARRANTY, EXPRESS OR IMPLIED IS STATED OR INTENDED.

### I. SIZE/WEIGHT

	9826A	9836A	9836C
Height:	184 mm (7.25 in.)	452 mm (17.8 in.)	452mm (17.8 in.)
Width:	432 mm (17 in.)	432 mm (17 in.)	432mm (17 in.)
Depth:	654 mm (25.75 in.)	654 mm (25.75 in.)	704.8mm (27.75 in.)
Weight:	20.5 kg (45.1 lb)	35.3 kg (78 lb)	40.8 kg (90 lb)

### II. POWER AND VOLTAGE RATINGS

#### A. Max Normal Load Power Consumption (full I/O, running self test)

	9826A	9836A	9836C
100V setting:	2.8 A	3.5 A	5.5 A
120V setting:	2.4 A	3.2 A	5.5 A
220V setting:	1.3 A	1.7 A	2.7 A
240V setting:	1.2 A	1.6 A	2.7 A
	210W	300W	430W

#### B. Maximum Power Consumption - 240 watts

#### C. Voltage Specifications

##### 1. Voltage ranges for each voltage setting

100V setting:	90 - 110 volts
120V setting:	108 - 132 volts
220V setting:	198 - 242 volts
240V setting:	216 - 250 volts maximum

- When the actual voltage is below the specified range, distortion of the CRT image may occur, cooling fans may heat up, and the machine's integrated circuits may be destroyed.
- When the voltage is above the specified range, erratic operation may result, followed by a failure of the power supply. Failure of the power supply may also damage other components of the 9826A.

## D. Susceptibility to Line Voltage Transients

The 9826A will typically survive 1000 volt pulses of one nanosecond rise time and 800 nanosecond duration, synchronous to the line frequency, without damage to the machine. (Pulse frequency not to exceed line frequency.)

## E. Susceptibility to Power Line Sag/Surge

## 1. Sag and Surge (Class B - Four-range instruments)

The 9826A will withstand input power supply voltage transients of .5 second duration which are within the range of voltages shown below with no loss of performance visible to the user:

Nominal Line Volts	Specified Limit Volts	Transient Limit Volts
100	90	70
100	110	130
120	108	84
120	132	156
220	198	154
220	242	286
240	216	168
240	250	312

## F. Line Frequency Specifications

Forty eight (48) to sixty six (66) Hz. Damage may result to the machine if any power supply outside the range of these conditions is used.

## III. AGENCY LISTINGS

Underwriter's Laboratories (UL) 114,478  
Complies with IEC 380  
CSA C22.2 No. 154

## IV. DUTY CYCLE LIMITATIONS, FAILURE MODES

## A. Disc Media Life

Typical media life is 2.5 million revolutions which is equivalent to about 138 hours of rotation access time. (Under normal operation, the disc rotates only for read or write operations.)

B. Other Component Typical Life

The 9826A keyboard keyswitches have a limited susceptibility to acids, some organic solvents, airborne pollutants and dust. Keyswitches may stick or be subject to premature failure in these environments.

C. Average Failure Rate

The 9826A is expected to experience an average failure rate of about 50% per year.

Due to different operating environments, the average failure rate may vary widely among individual machines.

V. OPERATING AND STORAGE TEMPERATURE SPECIFICATIONS—Class B

A. Ambient Temperature

Operating: 0 to 55 degrees C  
 Non-operating: -40 to +75 degrees C

NOTE: Disc media will not operate properly when subjected to these temperature extremes. See the disc media section for more information.

B. Relative Humidity

Operating: 5% to 95%, with max wet bulb temp not to exceed 40 deg C

NOTE: Disc media may not operate properly when subjected to these humidity extremes. See the disc media section for more information.

VI. ELECTROMAGNETIC EMISSIONS

A. Radiated Emissions

All numbers referring to radiation limits are measured in the far field with the 9826A in operation.

The 9826A complies with the Verband Deutscher Electrotechniker (VDE) 0730. The 9826A is expected to meet all Federal Communications Commission (FCC) regulations by introduction.

Radiation Limits in micro-volts/meter  
and dB (micro-volts /meter)

Frequency in MHz	Distance from Equipment	Limit Micro Volts per Meter	dB (micro-volts /Meter)
From .01 to 30	30 m	50	34
Above 30 to 470	10 m	50	34
Above 470 to 1000	10 m	200	46

See CISPR publication 11, 1975 for methods of measurement.

The 9826A will be tested with each of its interface cards and is expected to meet the requirements of the above radiation limits.

Peripherals connected to the 9826A through an interface card will alter the radiation patterns, because of this, some configured systems of the computer and peripherals may not meet the VDE Class B radiation limits which are specified above.

B. Conducted Emissions (Through the Power Line)

The 9826A complies with the international recommendations of the CISPR Publication 11 limits, level B.

## VII. ELECTROMAGNETIC SUSCEPTIBILITY

A. Electrostatic Discharge Susceptibility

An electrostatic discharge is generally experienced when a person who has built up a charge of "static electricity" touches an object. This is simulated by discharging a 300 picofarad capacitor charged to -15,000 volts through a 500 ohm resistor to various points on the computer. This will not cause any degradation of performance which is visible to the user.

B. Susceptibility to Radiated Emissions

The 9826A experiences no degradation of performance when it is subjected to a radiated field of 3 volt/meter over the frequency range of 14 kHz to 450 MHz.

C. Susceptibility to Conducted Interference (From the Power Line)

The 9826A will typically experience no degradation of performance when subjected to the following conditions:

3 volts r.m.s. on the power line from 30 Hz to 50 Hz  
1 volt from a 50 ohm source from 50 kHz to 400 MHz

See also Section II, part D on susceptibility to line voltage transients.

## VIII. PREVENTIVE MAINTENANCE

A. Case

The 9826A case can be cleaned using a soft, moist cloth. Do not use harsh or abrasive detergents, particularly on the CRT display. Do not allow moisture to penetrate the the computer. Remove the power cord from the 9826A when cleaning to safeguard against the possibility of electric shock.

## IX. OTHER

A. Atmospheric Limitations

Use of the 9826A in salt spray, dusty or corrosive chemical environments will elevate the number of failures.

Disc media should be protected and stored in clean environments when not in use. The keyboard is susceptible to dust contamination. As a result, keyswitches may tend to stick in dusty environments as dust contaminates the keyboard mechanism.

B. Attitude

The 9826A will not be damaged when operated in any attitude.

C. Shock

The 9826A typically can withstand a shock intensity of 30g's in any plane during a half-sine shock pulse with a duration of 11 milliseconds without physical damage to the computer. The 9826A may withstand other shock intensities or durations but has not been tested to other limits.

D. Vibration

The 9826A typically can withstand a vibration of 5 to 55 Hz with a sine wave peak to peak amplitude of 0.38 mm.

The 9826A may withstand other vibration frequencies or amplitudes but has not been tested to other limits.

E. Altitude

Operating	0 to 4,600 m (0 to 15,000 ft)
Non-operating	-300 to 15,200 m (-1,000 to 50,000 ft)

X. DISC MEDIA CONSIDERATIONS

NOTE: These guidelines are for HP disc media only (P/N 92190A)

A. Operating Temperatures

Environmental conditions of 25 degrees C and 20 to 50% relative humidity are most favorable for a long media life. However, disc media may be operated within the following range of specifications:

Temperature:	10 to 40 degrees C
Relative humidity:	20 to 80 %
Max wet bulb temperature:	25.5 degrees C

B. Storage Temperatures

Ten degrees C to 50 degrees C, eight to 80% non-condensing relative humidity.

The shelf life of the media will be reduced at the temperature extremes.

C. Shelf Life

Five year minimum when stored in a dirt-free environment not to exceed 50 degrees C.

D. Conditions Which Will Shorten Disc Media Life

Media life is decreased by a high duty cycle and by continuous use over a long period of time. It is recommended that the media be accessed no more than 10% of the time.

The most common media failure mode is destruction of the directory tracks on the media. When the directory is destroyed by read/write head contact, the computer operating system cannot access files which are stored on the media.

Disc media should be protected from dust and stored in a clean environment when not in use.

# Chapter 3

## 9826/9836 Configuration

### Computer Configuration Chart

Description	9826	9836A	9836C
Base Motherboard	09826-66501	09826-66502 09836-66502	09836-66502
Display Motherboard	none	none	09836-66503
Backplane Connectorboard	09826-66581	09826-66581	09826-66581
Rectifier board	09826-66552 09826-66554	09826-66554	09826-66554
Regulator board	09826-66551 09826-66553	09826-66553	09826-66553
Display Power Supply	none	none	09836-66550
Disc Drive Controller board	09826-66561 09826-66562	09826-66562	09826-66562
Disc Drive Mechanism	09130-66600	09130-66600	09130-66600
Keyboard Assembly	09826-68012	09826-68012	09826-68012
Processor board	09826-66511 09826-66514 09826-66515 09826-66516	09826-66515 09826-66516	09826-66516
Graphics board	09826-66575	09826-66577	09836-66573
Digital board	09826-66573	09826-66576	09836-66572
Analog board	09826-66571	09826-66580	none
Video board	none	none	09836-66542
Sweep board	none	none	09836-66540
CRT Assembly	09826-67921	09826-67922	09836-67924

### Computer Options Chart

Description	9826	9836A	9836C
Powerfail board	09826-66555	09826-66555	09826-66555
64k RAM	09826-66522 09826-66523	09826-66522 09826-66523	09826-66522 09826-66523
256k RAM	09826-66524	09826-66524	09826-66524



## 3-2 9826/9836 Configuration

# Chapter 4

## 9826/9836 Troubleshooting

### Initial Troubleshooting Flowchart

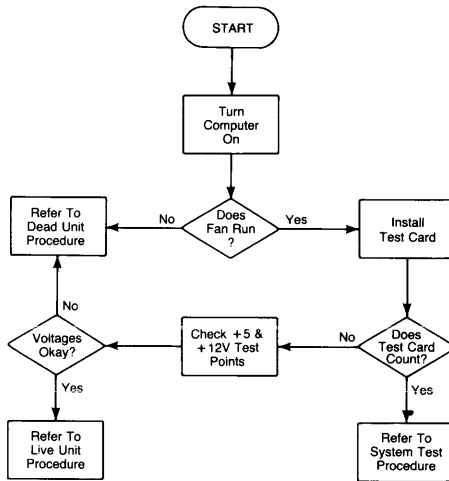

# Dead Unit Troubleshooting Flowchart

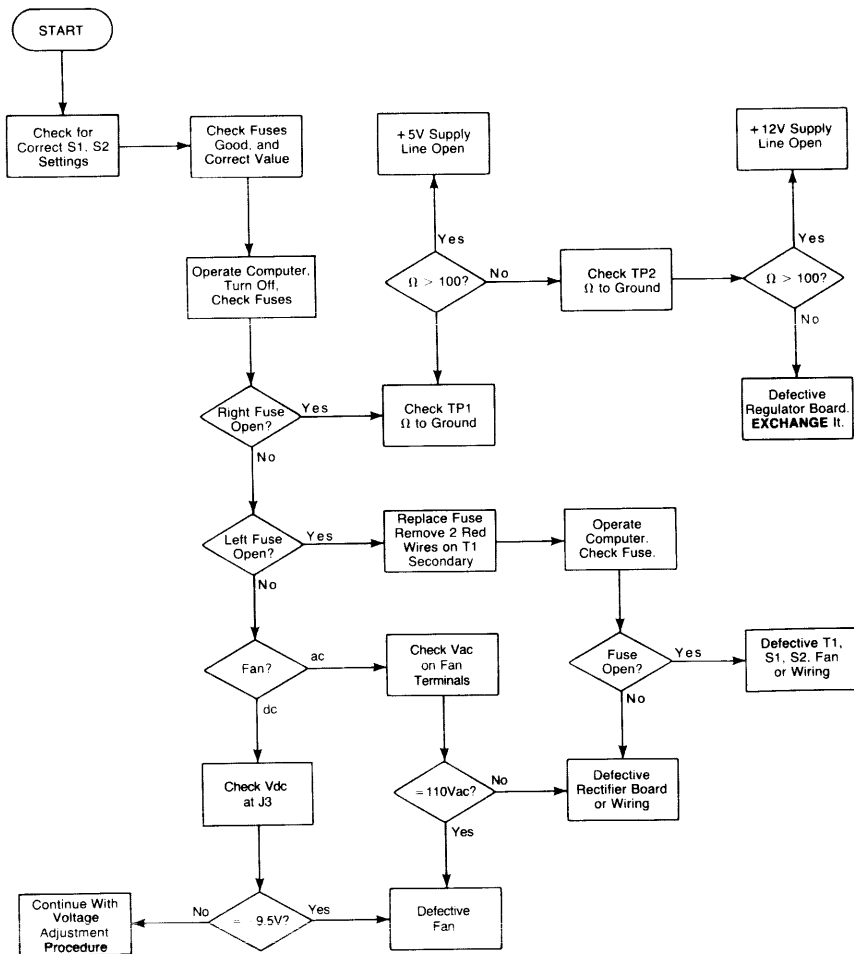

## Live Unit Flowchart

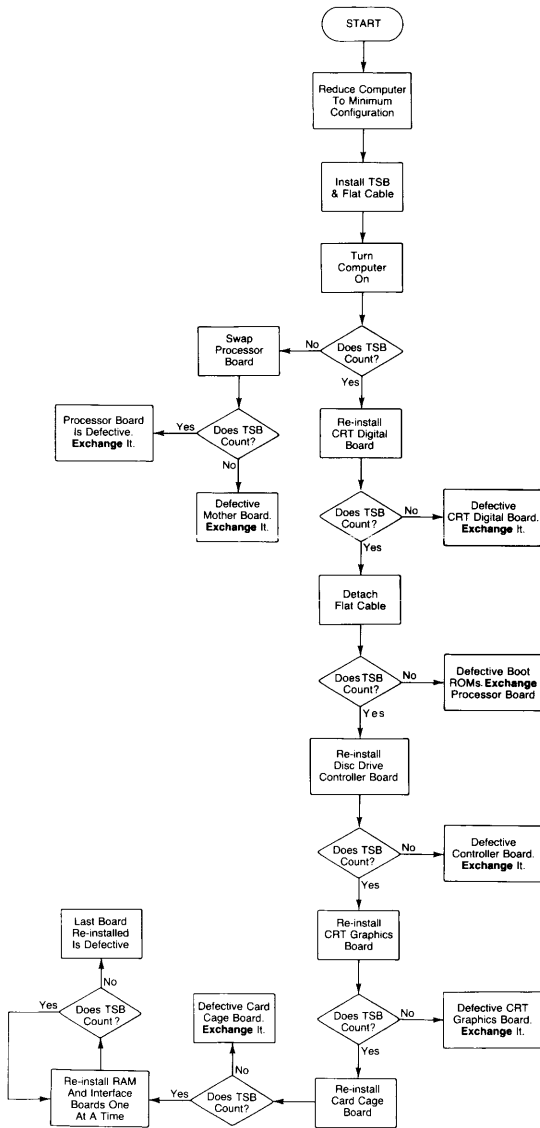

# Initial Display Troubleshooting Flowchart

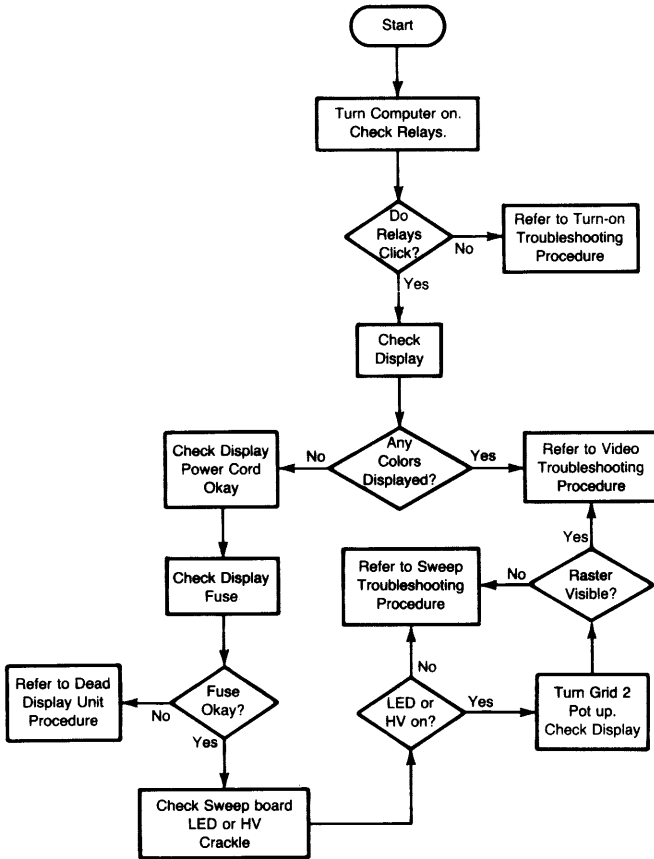

## Display Turn-on Troubleshooting Flowchart

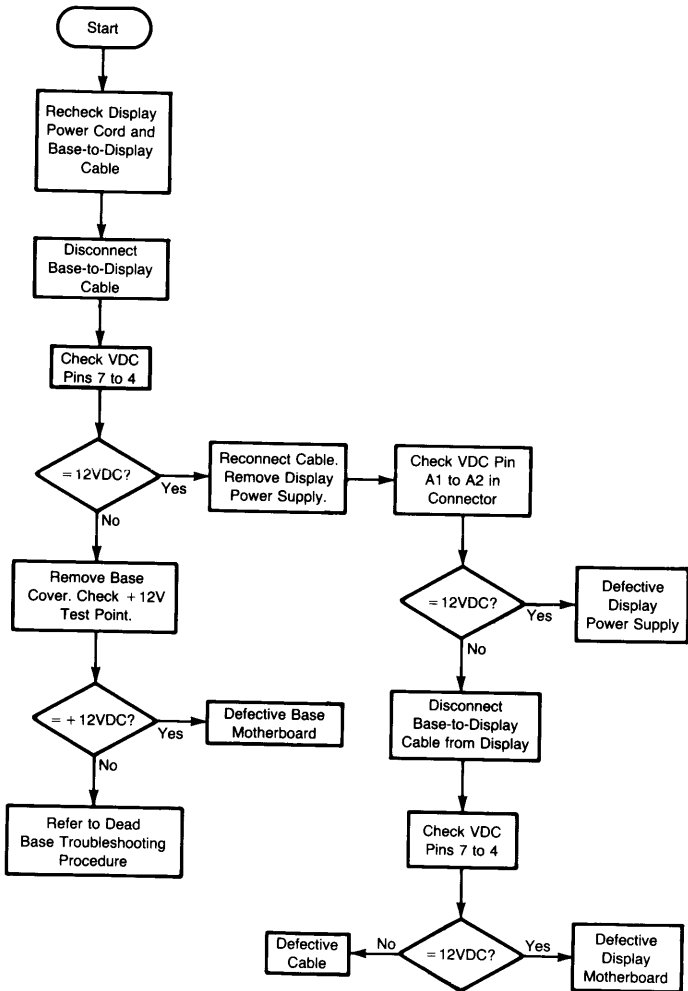

## Display Dead Unit Troubleshooting Flowchart

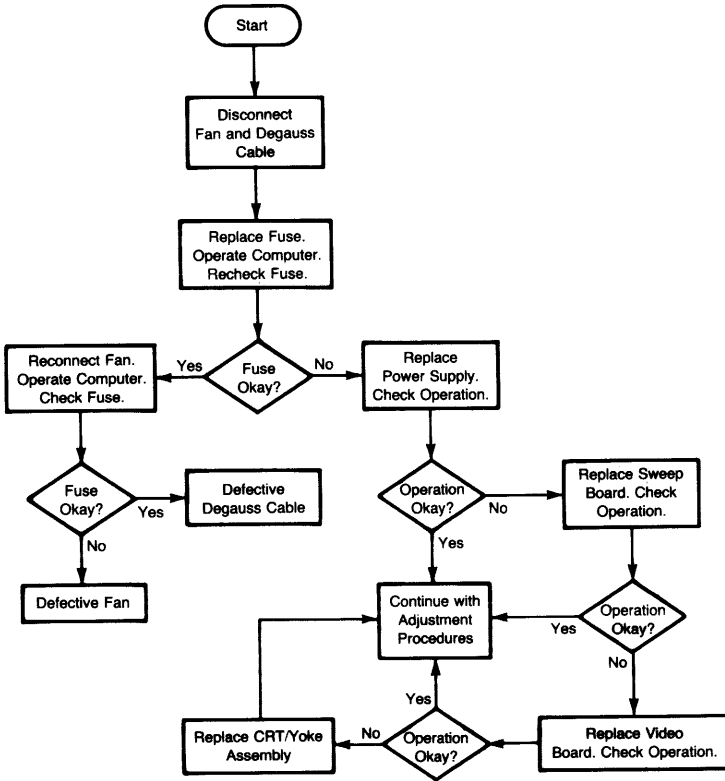

## Sweep Troubleshooting Flowchart

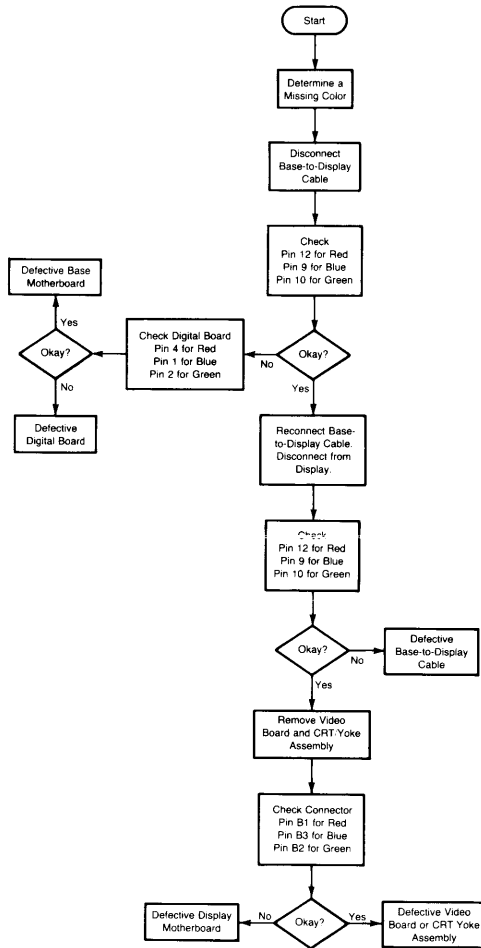



## Video Troubleshooting Flowchart

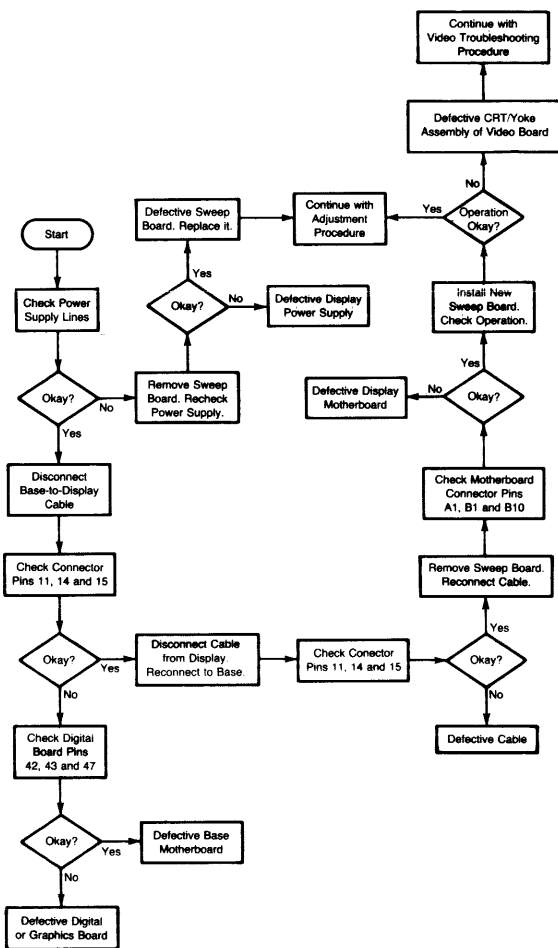

# Chapter 5

## 9826/9836 Diagnostics

### System Test Procedure Flowchart (Disc)

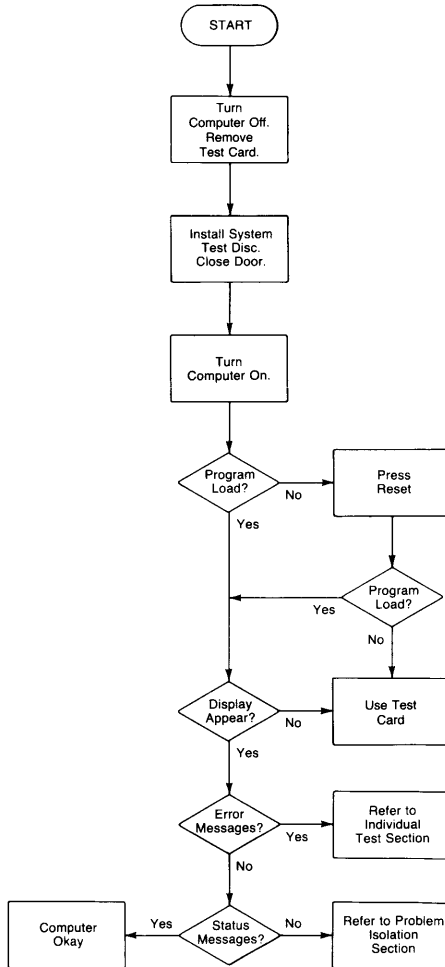

# System Test Procedure Flowchart (ROM)

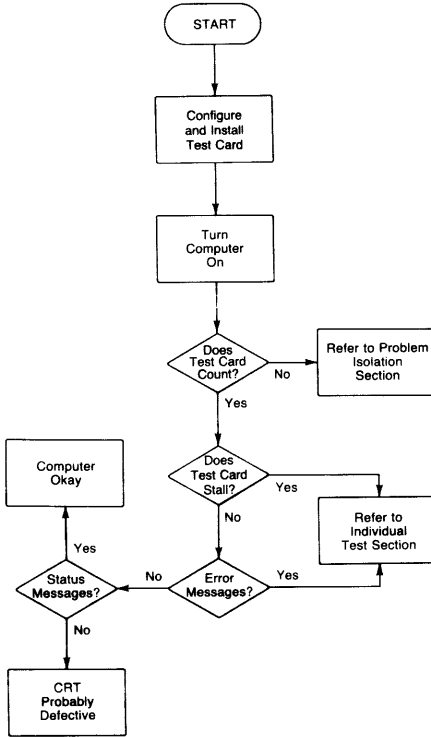

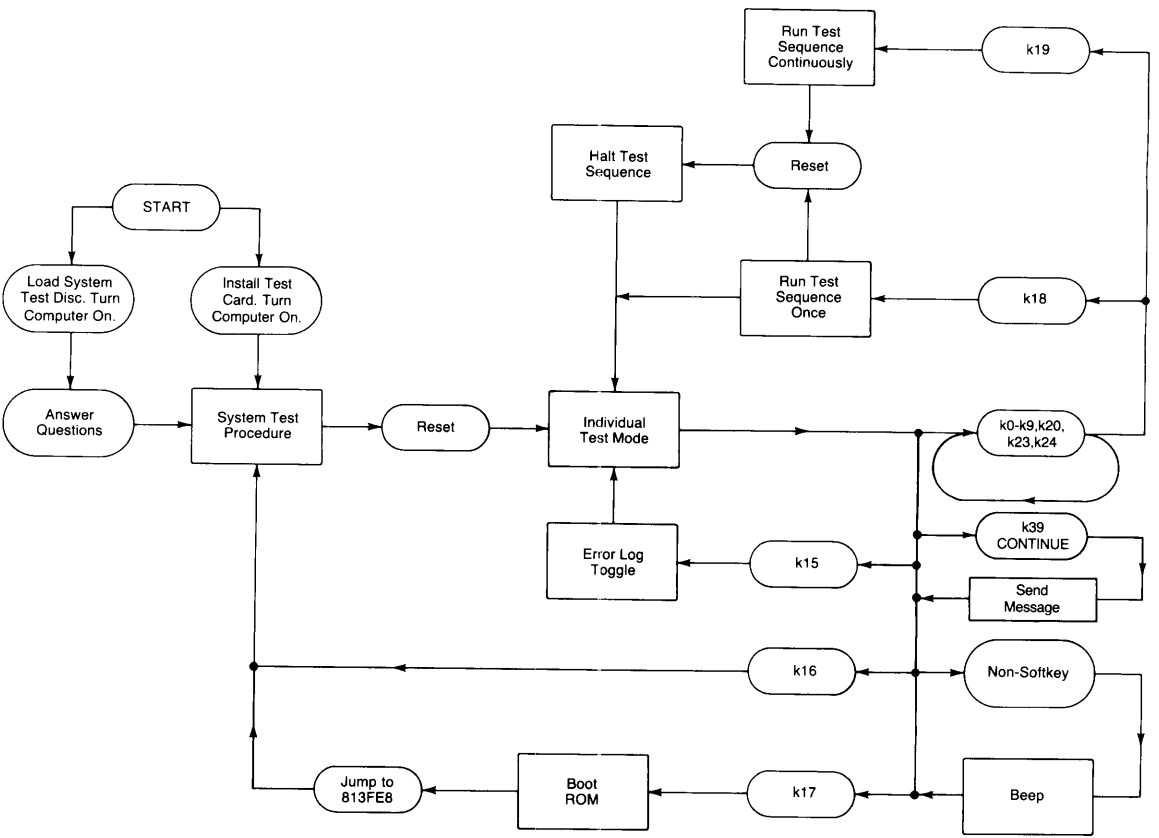

# Softkey Assignment Flowchart

## Softkey Definition List

The individual test mode is entered from the system test procedure by pressing the RESET (SHIFT PAUSE) key. The message TEST MODE will appear on the CRT. In test mode, the softkeys are defined to perform specific tests when pressed. The softkey definitions are as follows:





- k0 - Processor test
- k1 - ROM checksum test
- k2 - RAM pattern test
- k3 - CRT character test
- k4 - Keyboard test
- k5 - Disc drive test
- k6 - Extended RAM test
- k7 - CRT graphics test
- k8 - Extended CRT graphics test
- k9 - Disc drive diagnostic test
- k20 (CONTROL k0) - Powerfail board
- k23 (CONTROL k3) - CRT alignment patterns

The seven tests in the system test procedure are identical to the above tests with the same name. Also, the number display by the test stimulus board LED is the digit of the softkey.

In addition to these softkey definitions, there are some definitions using the SHIFT key in conjunction with the softkeys. These definitions are as follows:

- k15 (SHIFT k5)                      Toggles the HP-IB error log function. k15 is similar to the LOG switch on the test stimulus board. Refer to the section on error logging in the system test procedure.
- k16 (SHIFT k6)                      Causes the diagnostic procedure to exit from test mode and return to the system test procedure.
- k17 (SHIFT k7)                      Causes the diagnostic procedure to exit from test mode and branch to the boot ROMs. This will allow any operating system installed to begin executing. If the system test disc is installed, it will start over with the first test.
- k18 (SHIFT k8)                      Executes the selected test sequence once.
- k19 (SHIFT k0)                      Executes the selected test sequence continuously.
- k39 (SHIFT CONTROL k9)           Provides the operator a method for sending a message to the error reporting device (CRT or external printer). The operator presses k18 for one line of text, or k19 for several lines, then enters a line of text and presses the ENTER key after each line.

These softkey definitions provide a means of selecting a test or sequence of tests which would assist the user in the diagnostic process. An example of how to use these softkey definitions might be the following:

-  k3      CRT character test
-  k7      CRT graphics test
-  k8      Extended CRT graphics test
-  k19     Execute the above sequence continuously

This "program" will continuously execute the three CRT tests. A pass count is displayed on the CRT after each pass.

The "program" can be aborted by using RESET (SHIFT PAUSE).

## Early Boot ROM Error Codes

Error Message	Likely Causes
MEMORY FAILURE AT XXMNPQRS	More than one RAM board is set to address MN0000. Refer to the section on Checking the RAM Board Address.
INSUFFICIENT USABLE MEMORY	The CPU can not locate enough RAM to operate. The most likely cause is that there is a gap in RAM addressing. RAM boards must be addressed consecutively starting with FF0000. Refer to the section on Checking the RAM Board Address.
NOT ENOUGH MEMORY FOR SYSTEM	
NEED RAM ABOVE FF8000	If the RAM is correctly addressed, there is a CPU bus problem which can not be fixed by the user.
KEYBOARD FAILED SELF-TEST	This occurs if more than one language or configuration jumper is installed under the keyboard or if several keys are held down when the machine is turned on. If these have been eliminated, the keyboard controller or chip select are defective.
FLOPPY ERROR #XX,YYY	The most likely cause of this error is bad media. Try a known-good disc. If the error remains, the drive is defective. Try replacing the drive with a known-good one.
FATAL FLOPPY ERROR #XX,YYY	The most likely cause of this error is a defective drive. Replace it with a known-good one. If the error remains, the disc drive controller is defective. Try replacing the controller board with a known-good one.

## 3.0 Boot ROM Error Codes

CRT Message	Refer to Section
BOOTROM X.Y Failed	Boot ROM Memory Test
ROM X at MNPQRS Failed	ROM Memory Test
ROM X at MNPQRS Ignored	ROM Memory Test
RAM Gone Above FFC000	RAM Memory Tests
RAM Failed Above FFC000	RAM Memory Tests
Memory Failed at XXXXXX W:ZZZZZZZ, R:YYYYYYYY	RAM Memory Tests
Alpha Failed	Display Tests
Alpha Missing	Display Tests
Graphics Failed	Display Tests
Graphics Missing	Display Tests
Keyboard Failed	Keyboard Test
Keyboard Missing	Keyboard Test
HP-IB Failed	I/O Tests
HP-IB Missing	I/O Tests
HP9862Y at SC Failed	I/O Tests
HP9862Y at SC Missing	I/O Tests
DMA Failed	I/O Tests
DMA Missing	I/O Tests
Flexible Disc Failed	Disc Drive Test
Flexible Disc Missing	Disc Drive Test
Battery Failed	Powerfail/Real Time Clock Test

LEDs	Hexadecimal Equivalent	Refer to Section
0000 0000	00	No Failure
0101 0010	52	Keyboard Test
0101 0100	54	I/O Tests
0101 0110	56	Disc Drive Test
0101 1000	58	I/O Tests
0101 1010	5A	Powerfail/Real Time Clock Test
0101 1110	5E	Display Tests
0101 1111	5F	Display Tests
011X XXXX	60 to 7F	I/O Tests
1000 0001	81	Processor Test
1000 0011	83	Boot ROM Memory Test
1000 0100	84	RAM Memory Tests
1000 1001	89	RAM Memory Tests
1000 1010	8A	RAM Memory Tests
1000 1011	8B	PROM Memory Test
1000 1101	8D	ROM Memory Test
1001 0010	92	Keyboard Test
1001 0100	94	I/O Tests
1001 0110	96	Disc Drive Test
1001 1000	98	I/O Tests
1001 1010	9A	Powerfail/Real-time Clock Test
1001 1110	9E	Display Tests
1001 1111	9F	Display Tests
101X XXXX	A0 to BF	I/O Tests
1111 1111	FF	LEDs Never Accessed

### Processor Test

LED Display	CRT Message	Probable Cause	What to Do
1000 0001	None	Defective CPU	Replace Processor Board

### PROM Memory Test

LED Display	CRT Message	Probable Cause	What to Do
1000 1011	PROM Failed	Defective PROM	Replace PROM (if socketed) Replace Processor Board

### System ROM Memory Test

LED Display	CRT Message	Probable Cause	What to Do
1000 1101	ROM X at MNPQRS Failed	Defective ROM at address MNPQRS	Replace ROM System at MNPQRS Replace Processor Board
1000 1101	ROM at MNPQRS Ignored	ROM at address MNPQRS only supports 50 character wide CRT	Replace system ROM at address MNPQRS Ignore the Message

## RAM Memory Tests

LED Display	CRT Message	Probable Cause	What to Do
1000 0100	NEED GOOD RAM ABOVE FFC000	Defective RAM in top 16k bytes	Check addressing of RAM
1000 1010	Insufficient RAM for self test	Replace processor board	
1000 1001	Memory Failed at XXXXXX W:ZZZZZZZZ, R:YYYYYYYY	RAM incorrectly addressed	Check RAM addressing
		Defective RAM	Replace processor board

## Display Tests

LED Display	CRT Message	Probable Causes	What to Do
1001 1110	Alpha Failed	Defective Digital Board	Replace Digital Board
0101 1110	Alpha Missing	Defective Processor Board	Replace Processor Board
1001 1111	Graphics Failed	Defective Graphics Board	Replace Graphics Board
0101 1111	Graphics Missing	Defective Processor Board	Replace Processor Board

## Keyboard Test

LED Display	CRT Message	Probable Cause	What to Do
1001 0010	Keyboard Failed	Defective Keyboard Electronics	Replace Motherboard
0101 0010	Keyboard Missing	Defective I/O Select Hardware	

## Disc Drive Test

LED Display	CRT Message	Probable Cause	What to Do
0101 0110	Flexible Disc Missing	Defective Drive Control Board	Replace Drive Control Board
1001 0110	Memory Failed at XXXXXX W:ZZZZZZZZ, R:YYYYYYYY		Replace Disc Drives
1001 0110	Flexible Disc Failed	Defective Drive Control Board	
		Defective Disc Drive	



### I/O Tests

LED Display	CRT Message	Probable Cause	What to Do
1001 0100	HP-IB Failed	Defective HP-IB Hardware	Replace Motherboard
0101 0100	HP-IB Missing	Defective I/O Select Hardware	
0101 1000		Defective DMA Card	Replace DMA Card
1001 1000	Defective I/O Select Hardware	Replace Motherboard	
		Replace Backplane Connectorboard	
101P QRST	HP9862Y at SC Failed	Defective I/O Board at select code SC (PQRST is the hexadecimal form of select code SC)	Replace I/O Board at select code SC
011P QRST	HP9862Y at SC Missing		Replace Motherboard
			Replace Backplane Connectorboard

### Powerfail/Real-Time Clock Test

LED Display	CRT Message	Probable Cause	What to Do
0101 1010	Battery Missing	Defective Powerfail Board	Replace Powerfail Board
1001 1010	Battery Failed		

## System Test Error Codes

### Processor Test

NO RAM @ FF

No RAM was found at location FFXXXX and a bus error was detected.

### Memory Section

ROM @ XXXXXX REVERSED

The upper byte and lower byte ROMs are reversed. If the ROMs are in sockets, the two ROMs at that address should be switched, and the test re-run.

ROM CHECKS XXXX @  
YYYYYY

A checksum error was detected in the ROM at address YYYYYY. If the address is even, the upper byte is defective; if it is odd, then the lower byte is defective. The value XXXX is the checksum found, rather than the correct one, FFFF.

RAM W/B @ XXXXXX

Data was written at address XXXXXX, then read back. Data read back was not the same as data written.

RAM @ XXXXXX had  
YYYYYYYY not ZZZZZZZZ

The RAM located at address XXXXXX contained YYYYYYYY and should have contained ZZZZZZZZ.

RAM RFSH @ XXXXXX had  
YYYYYYYY not ZZZZZZZZ

The RAM located at XXXXXX did not refresh correctly. The data read was YYYYYYYY and should have been ZZZZZZZZ.

RAM CONFIG @ XXXXXX

There is an error in the RAM board addressing. RAM board addresses must be contiguous and non-overlapping.

ROM ADDR had XXXXXX @  
YYYYYY

The ROM header ADDR parameter has XXXXXX at the ROM address YYYYYY.

ROM # has XXXX not YYYY @  
ZZZZZZ

The number in the ROM header at location ZZZZZZ was XXXX and should have been YYYY. **NOTE**—If you receive this message for all the ROMs on a BASIC 2.1 board, they are probably okay.

ROM L = " "@ XXXXXX

The ROM header at location XXXXXX has a 'Language' parameter of " ".

UNABLE TO DRIVE

The drive signal did not replace the boot ROM with the test code.

UNABLE TO REMOVE DRIVE

The drive signal cannot be removed.

CPU BOARD SIZE ERROR ##

The PROM on the CPU board exceeds the maximum size.

RELOCATE FAILURE @ XXXXXX

A verify error occurred when the soft test code attempted to relocate to location XXXXXX.

RAM SPEED YYYY @ XXXXXX  
(ZZZZ,WWWW)

The RAM at location XXXXXX had a speed of YYYY, which is not within limits (ZZZZ,YYYY).

NO RAM @ FF

No RAM was detected at location FFXXXX and a bus error was detected.

NO RAM SPEED @ XXXXXX-  
KBD BAD?

No RAM speed test conducted at location due to defective keyboard clock (which is used to measure RAM speed).

BUS ERROR @ XXXXXX IN K#

The test code detected a bus error at RAM location XXXXXX.

PON RAM @ XXXXXX had  
YYYYYYYY not ZZZZZZZZ

The first write of the RAM at location XXXXXX was ZZZZZZZZ. The first read was YYYYYYYY.

### CRT Section

RAM @ 51XXXX had  
YY not ZZ

The display RAM located at address 51XXXX contained 000000YY and should have contained 000000ZZ.

NO GRAPHICS IN K#

This message is displayed if a bus error takes place when attempting to access the graphics RAM.

RAM @ 53XXXX had  
YY not ZZ

The graphics RAM located at address 53XXXX contained 000000YY and should have contained 000000ZZ.

RAM RFSH @ 53XXXX had  
YYYYYYYY not ZZZZZZZZ

The graphics RAM located at 53XXXX did not refresh correctly. The data read was YYYYYYYY and should have been ZZZZZZZZ.

RAM HOLD @ 51XXXX had YYYY not ZZZZ	The CRT RAM at location 51XXXX failed to hold data for one second.
NO ALPHA IN K#	A bus error was detected when accessing the CRT alpha RAM.
NO GRAPHICS IN K#	A bus error was detected when accessing the CRT graphics RAM.
COLOR MAP @ XXXXXX had YYYY not ZZZZ	The data at color map location XXXXXX was YYYY and should have been ZZZZ.
VERTICAL BLANK STUCK HIGH	The vertical blank bit in the CRT ID register is stuck high.
VERTICAL BLANK STUCK LOW	The vertical blank bit in the CRT ID register is stuck low.

## Keyboard Section

LVL 1 INT XXYZZ	The interrupt system was enabled and a level 1 interrupt occurred. No keyboard interrupts were expected. The keyboard controller generated the interrupt.
KBD FAILED SLTST	A reset signal was sent to the keyboard but the keyboard did not respond with an interrupt status. A possible cause is a checksum error in the keyboard controller.
KBD STS XX NOT 71	The keyboard status after a reset was XX and should have been 71.
KBD DATA XX NOT 8E	The keyboard data after a reset was XX and should have been 8E.
KBD NOT RDY, XXXXXX	The keyboard status indicates that the keyboard was not ready to accept a command or data.
KBD NOT INT W/DATA	The keyboard was requested to interrupt and present data. The interrupt line or the keyboard controller may be defective.
KBD INT NO CAUSE XX	The status obtained upon interrupt from the keyboard was incorrect, or bit 0 was not set.
KBD INT MASK	The data obtained upon keyboard interrupt for interrupt mask data was not the expected value of 1F (hex).
KBD TIMER SLOW OR NO INT XX (YY.ZZ)	The system 10 msec timer on the keyboard did not interrupt or was too slow. The problem could be the 8041 or the 10MHz crystal.
KBD TIMER FAST XX (YY.ZZ)	The system 10 msec timer interrupted, but was too fast. The problem could be the keyboard controller or the 10MHz crystal.
NO KBD NMI	The keyboard was requested to issue a non-maskable interrupt (NMI) after 10 msec. This is the fast handshake timeout interrupt. It did not take place. The problem could be the interrupt line, the keyboard controller or keyboard buffer.
LANG JMPR = X	X refers to the number in this table: 1 French 2 German 3 Swedish/Finnish 4 Spanish 5 Japanese (Katakana) 6 System jumper 9 7 System Jumper 10 8 System jumper 11
SYS JMPR = X	X refers to the number in this table: 1 System jumper 1 2 System jumper 2 3 System jumper 3 4 System jumper 4 5 System jumper 5 6 System jumper 6 7 System jumper 7 8 System jumper 8

KBD INT STATUS XX	The status obtained upon interrupt from the keyboard was not correct or bit 0 was not set. The status was XX.
KBD REAL TIME CLK BAD, #### DAYS, ##### Xms	The real time clock was set to 0, then read. The result was not 0.
KBD KEY CODE ##, STATUS ##	LOG is enabled or an out-of-range key code was found (<\$18 or >\$7D).
LVL 2 INT IN K#	An unexpected level 2 interrupt occurred when the 68000's 'Status Register' was set low enough for the keyboard's level 1 interrupt.

## Disc Drive Section

RAM @ 44EXXX had 000000YY not 000000ZZ	The disc RAM located at address 44EXXX contained 000000YY and should have contained 000000ZZ.
DRV D DISC FAST XXXX (YYYY.ZZZZ)	The motor is turning too fast. The time between index pulses is too short.
DRV D DISC SLOW XXXX (YYYY.ZZZZ)	The motor is turning too slow. The time between index pulses is too long.
DRV D DISC STS XX	Disc drive status is wrong. XX was read.
DRV D NO INT AFTER RES	The disc drive was expected to interrupt after a reset, but failed to do so.
DRV D DISC WRT XX RD YY	The data written as XX was read back as YY.
DRV D WRT PROCT	The disc is write protected. The rest of the disc drive test will be skipped.
DRV D TRK REG had XX not YY	The track register contained XX rather than YY.
DRV D TRK REG had XX not YY AFTER ZZ STS WW	The track register contained XX rather than YY. The last command given the drive was ZZ and the status returned was WW. This means that the heads did not properly step in or out and an incorrect track may have been written.
DRV D SEC REG had XX not YY	The sector register contained XX rather than YY.
DRV D DAT REG had XX not YY	The data register contained XX rather than YY.
DRV D NO TR00 AFTER XX	The track 0 switch was expected after the XX command, but did not occur.
DRV D TR00 TRUE AFTER XX	The track 0 switch was true after the XX command, but should not have been.
DRV D CLR EXSTS FAILED	The extended status bits 1 and 2 were to be cleared by a command, but one or both remain set.
DRV D DISC BUSY XXXXXX	The drive was busy when it should have been ready to receive the next command. The value XXXXXX is the address in the code where the command was given.
DRV D DISC TIMEOUT XXXXXX	The drive was given a command and failed to interrupt within a given period of time. The value XXXXXX is the address in the code where the command was given. The rest of the disc drive test will be skipped.
DRV D NO DISC OR NOT RDY	The ready status is required but there is no index pulse to enable it. No disc is installed or there is a failure. This message is displayed only once in a sequence of passes. The rest of the disc drive test is skipped.
DRV D MOTOR OFF & RDY	The drive remains ready although the motor is turned off.

DRV D NO INDEX	No index pulses are detected although the motor is running.
DRV D MARGIN	A margin error was detected while reading data from the disc.
DRV D READ ADD XXXXXX	An error was detected in a read address sequence.
DRV D CRC	The CRC read was not the same as the one generated by the program.
DRV D DISC FDC	The head load status indicator was not set.
DRV D NO FILE OR NOT ASCII	The "TROMDATA" file was not found on the disc or was the wrong type. The rest of the disc drive test will be skipped.
DRV D FILE SMALL	The "TROMDATA" file is too small. The "TROMDATA" must be of ASCII type and 80 records in length.
RAM HOLD @ 44EXXX had YY not ZZ	The disc drive RAM at location 44EXXX failed to hold data for a few seconds.
RAM SPEED YYYY @ 44EXXX (ZZZZ.WWWW)	The disc drive RAM at location 44EXXX had a speed of YYYY, which is not within limits (ZZZZ.WWWW).
DRV D LVL 2 INT	An unexpected level 2 interrupt occurred in drive D when the 68000's 'Status Register' was set low enough for the keyboard's level 1 interrupt.

## Powerfail Section

PF FAILED SLFTST	The powerfail assembly failed its self test.
PF RAM @ XX had YY not ZZ	The data in the powerfail RAM at location XX was YY and should have been ZZ.
PF CLOCK FAST XX	The powerfail clock is fast or the shift register is failing.
PF CLOCK SLOW XX	The powerfail clock is slow or not incrementing or the shift register is failing.
PF IBF/OBF/F1	The 8041 IBF, OBF and F1 flags did not respond correctly.
PF TIMEOUT @ XXXXXX	A timeout occurred while attempting to talk to powerfail unit at test code address XXXXXX.

# Chapter 6

## 9826/9836 Adjustments

### 9826 Adjustments, Jumpers and Switches

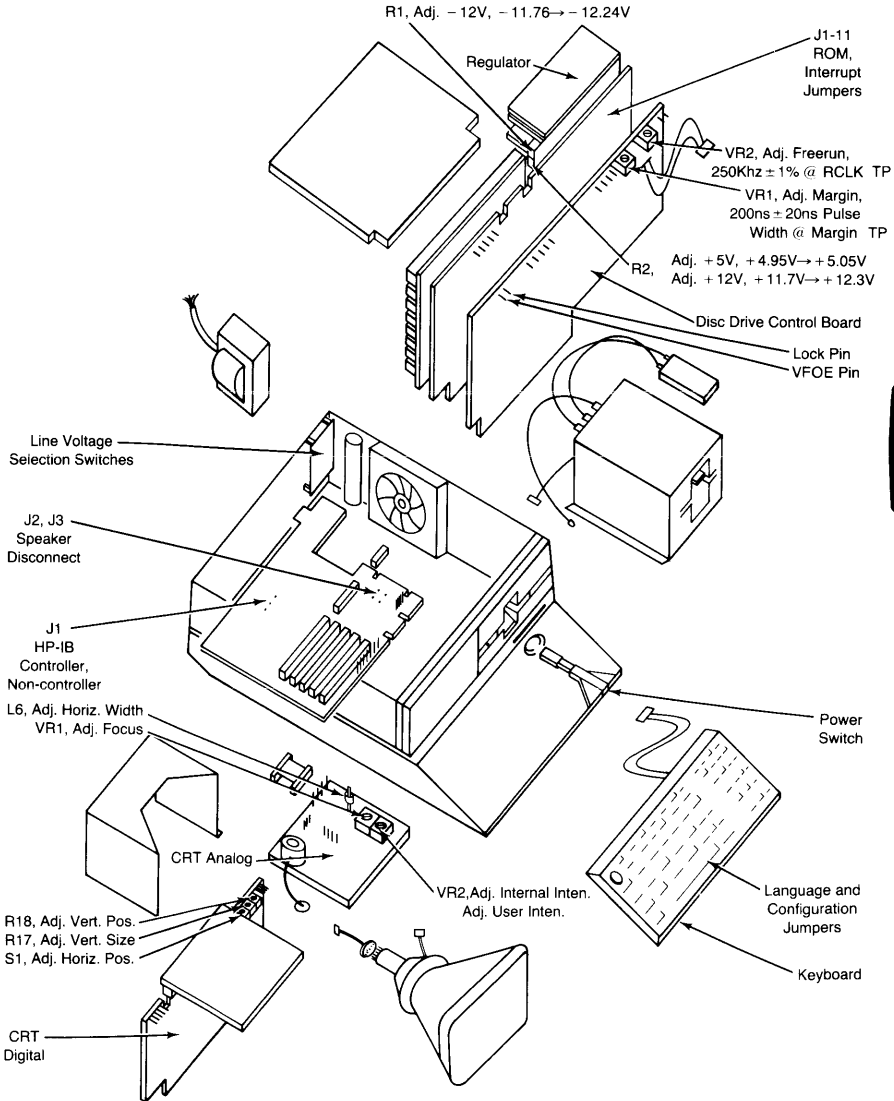

# 9836A Adjustments, Jumpers and Switches

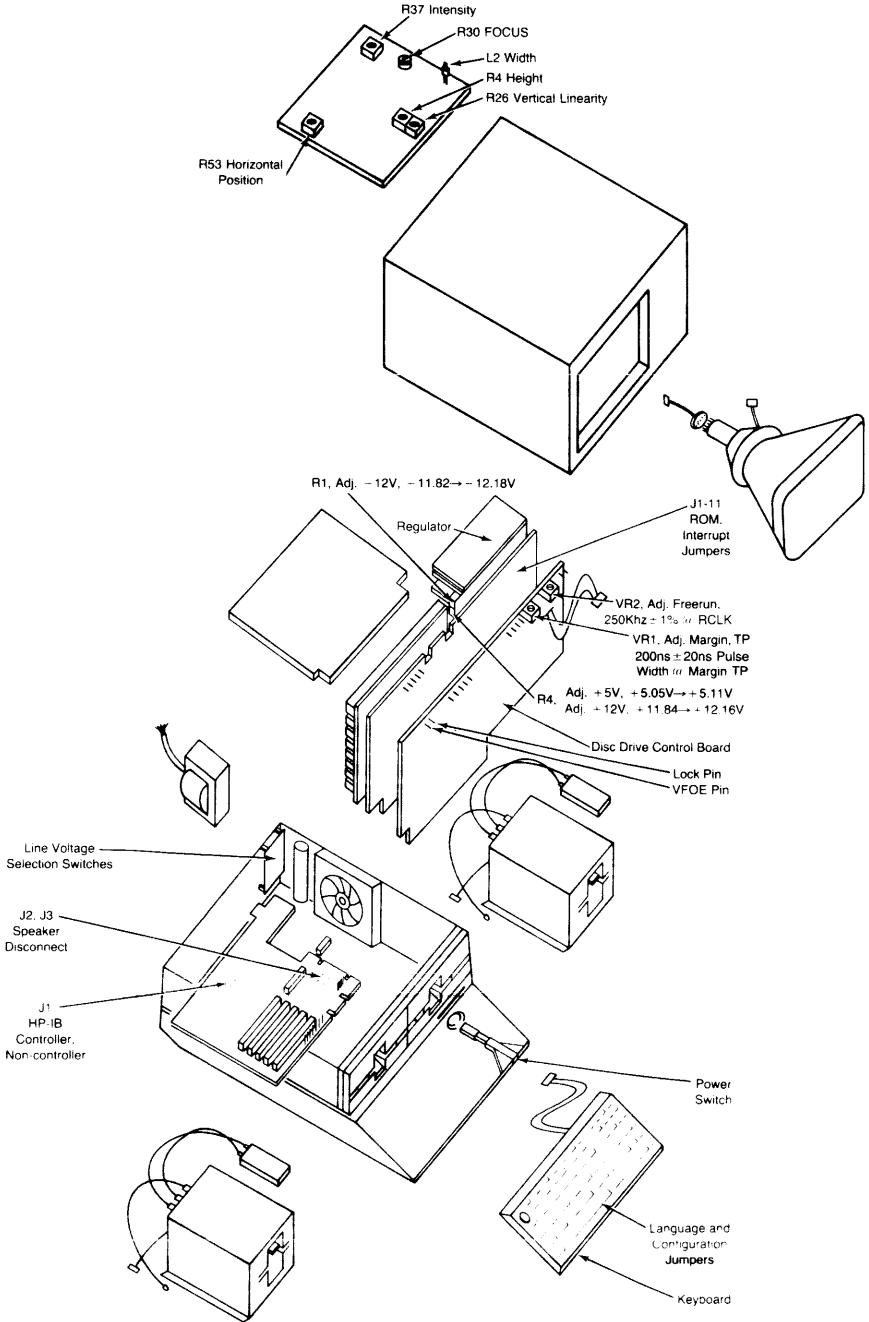

# 9836C Adjustments, Jumpers and Switches

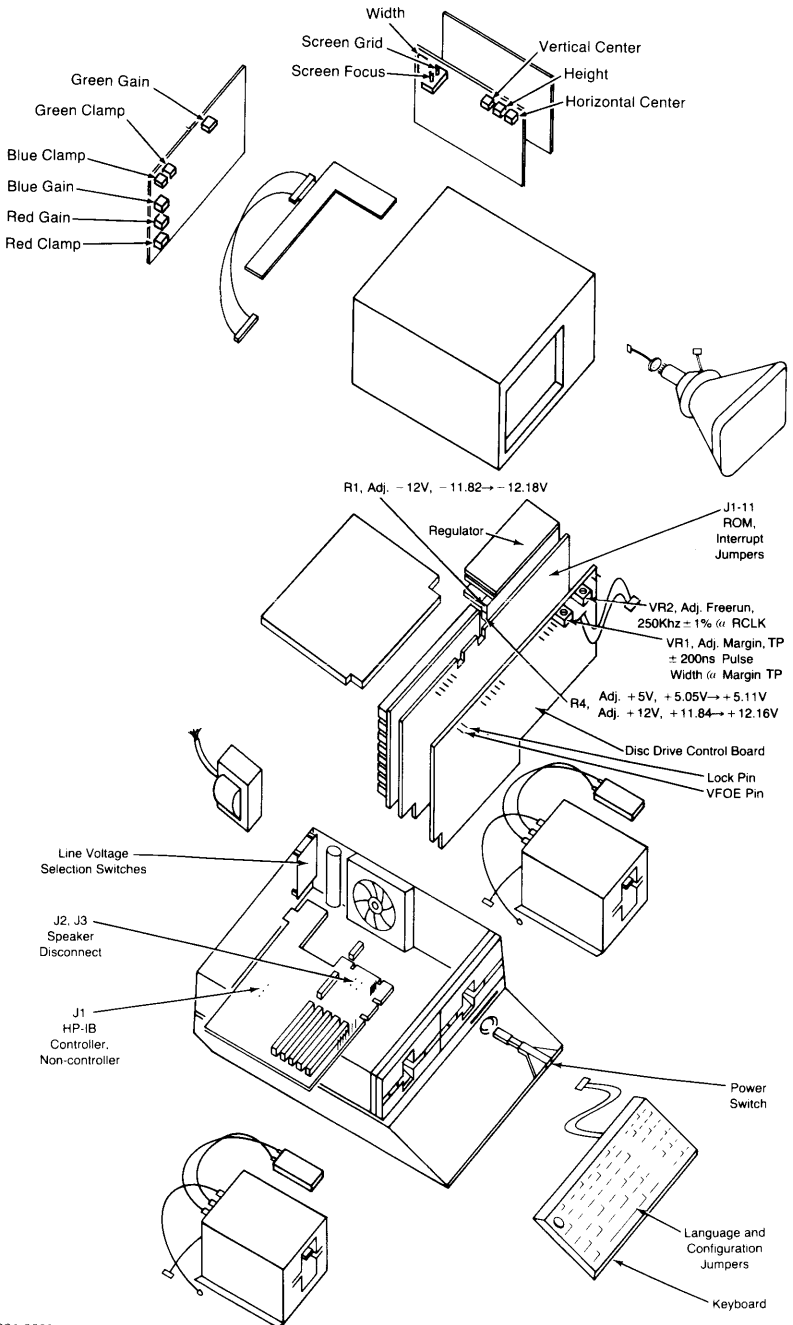



## Mainframe Jumper/Switch Chart

### Keyboard

Language Jumper		System Jumper	
1	French	1	System Jumper 1
2	German	2	System Jumper 2
3	Swedish/Finnish	3	System Jumper 3
4	Spanish	4	System Jumper 4
5	Japanese Kana	5	System Jumper 5
6	System Jumper 9	6	System Jumper 6
7	System Jumper 10	7	System Jumper 7
8	System Jumper 11	8	System Jumper 8
None	Standard		

### Motherboard

J1 Internal HP-IB System Controller/Non-controller  
 J2,J3 Speaker Disconnect

### Processor Board (09826-69514 or -69515)

J9 Interrupt 1  
 J11 Interrupt 2  
 J8 Interrupt 3  
 J7 Interrupt 4  
 J6 Interrupt 5  
 J5 Interrupt 6  
 J10 Interrupt 7

J1-J4 are used to accommodate different types of ROMs, such as EPROMs or ROMs and varying access times.

### Disc Drive Controller Board

VFOE TP jumpered to LOCK TP for margin adjustment.

### 9130K Drive Board

All jumpers installed (jumper shunt block)

### Test Card

Switches:

DRIVE causes Test Card to take control of the address bus.  
 TEST MODE allows selection of a specific test.  
 LOG HP-IB selects external data logging.

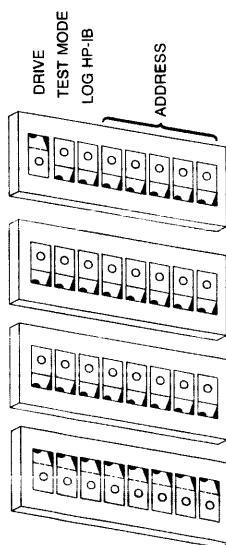

# Power Supply Adjustment Flowchart

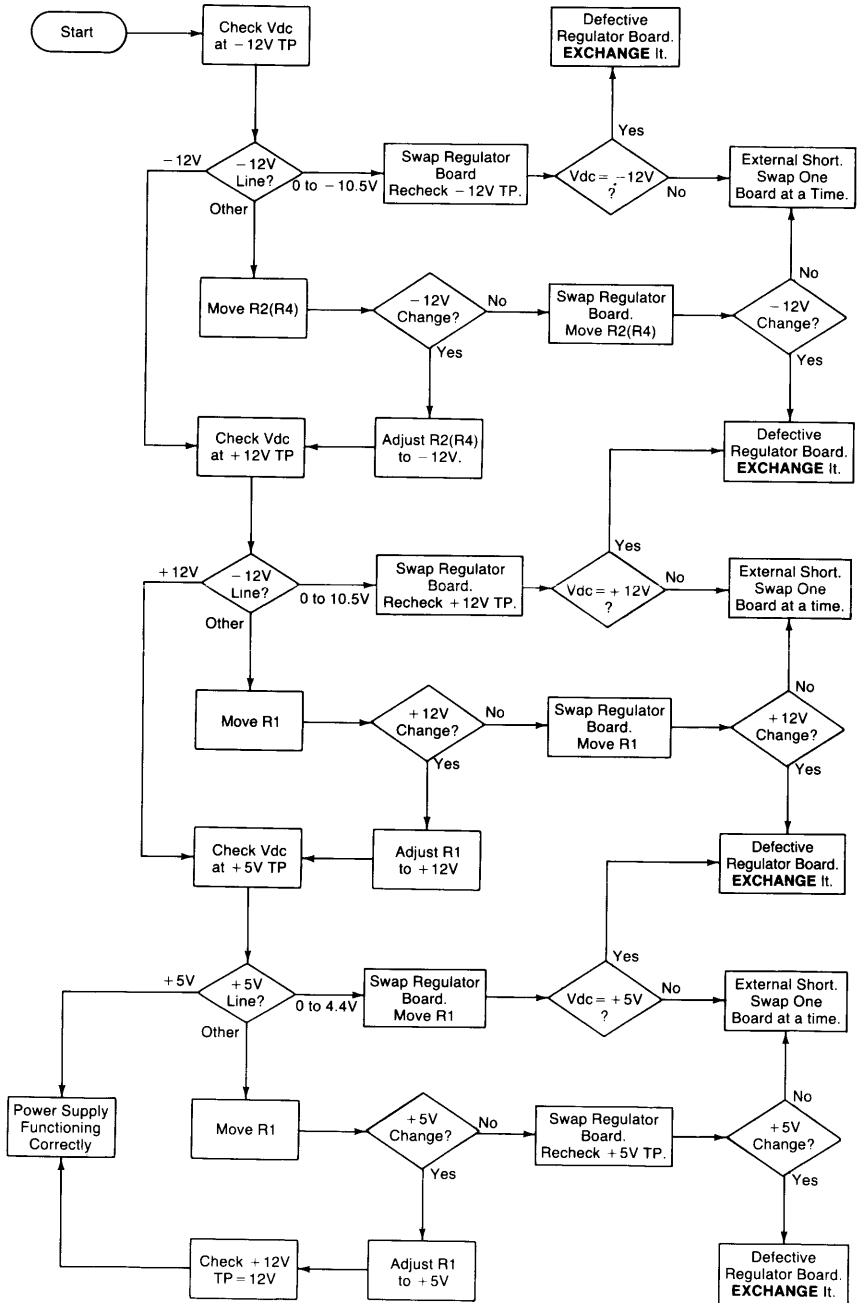

## 9826/9836 Adjustment Table

Electronic Test Equipment required for adjustments:

HP 1740 Oscilloscope or equivalent

HP 34768 DVM or equivalent

Photodyne 19XE Radiometer or equivalent

Assembly	Adjustment Name	Reference Designator	Specification	Comments
09826-66551 Regulator Board	- 12V	R1	- 11.76 to - 12.24V	Adjust first
	+ 5V	R2	+ 4.95 to + 5.05V	One adjustment for both V
	+ 12V	R2	+ 11.7 to + 12.3V	
09826-66553 Regulator Board	- 12V	R1	- 11.82 to - 12.18V	Adjust first
	+ 5V	R4	5.05 to 5.11V	One adjustment for both V
	+ 12V	R4	11.84 to 12.16V	
09826-66561 or 09826-66562 Disc Drive Control Board	Free Run	VR2	4 $\mu$ S $\pm$ .04 $\mu$ S @ RCLK TP (250 KHz $\pm$ 1%)	
	Margin	VR1	200nS $\pm$ 20nS Pulse Width @ Margin TP	Connect VFOE TP to LOCK TP
09826-66571 CRT Analog Board	Width	L6		Use K3, grid
	Focus	VR1	Full Pattern (k3, small e's)	400V high voltage present on adjuster
	Intensity (Int.)	VR2		User Intensity Maximum
	Intensity (user)	VR3	Personal Taste	
09826-66575 CRT Digital Board	Height	R17		Use k3, grid
	Vert. Pos.	R18		Use k3, grid
	Horiz. Pos.	S1		Use k3, grid
09826-66580 CRT Analog Board	Width	L2		Use k23, alignment
	Focus	R30	Full Pattern (k3, symbol)	400V high voltage present on adjuster
	Intensity (Int.)	R36		User Intensity Maximum
	Intensity (user)	R35	Personal Taste	
	Height	R4		Use k23, alignment
	Vert. Lin.	R26		Use k23, alignment
	Horiz. Pos.	R53		Use k23, alignment

Assembly	Adjustment Name	Reference Designator	Specification	Comments	
09836-66540 CRT Sweep Board	Height	VR3	} see Color Alignment Procedure	Use k3, grid	
	Width	L2		Use k3, grid	
	Horizontal Center	VR4		Use k3, grid	
	Vertical Center	VR2		Use k23, alignment	
	Focus	} on flyback		} Use k3, symbol	
Screen Grid					
09836-66542 CRT Video Board	Red Clamp	R117		} see Color Alignment Procedure	
	Red Gain	R113			
	Blue Clamp	R217			
	Blue Gain	R213			
	Green Clamp	R317			
	Green Gain	R313			

## Color Alignment Procedure

The color alignment procedure requires performing six tasks:

1. Set up the test conditions.
2. Determine the cathode cut-off points.
3. Adjust the screen grid.
4. Adjust the clamp and gain pots for the low cut-off gun (two iterations).
5. Repeat Task 4 for the middle cut-off gun.
6. Repeat Task 4 for the high cut-off gun.

Note that it is absolutely essential that the Tasks be performed in the above order. Each Task affects those which follow it.

---

### Note

The alignment procedure can be performed while the computer is operating at either 50 or 60 Hz. If done at 50 Hz, the computer will operate correctly at 50 or 60 Hz. If done at 60 Hz, it may not operate correctly at 50 Hz.

---

**Task 1, Set Up.** Turn the machine on to warm it up. If it is facing a window, move it so that it is facing away or close the drapes. Get all of the equipment ready. Remove the display cover and high voltage shield. Familiarize yourself with the location of the adjustment pots and test points. Also, position the intensity control at maximum. The intensity control is located under the left-hand edge of the base. Turn the control toward the front. There is no stop when the control reaches maximum, so turn it until the display stops getting brighter.

---

**Note**

The display chassis is coated with a non-conducting substance which makes it a poor ground. Therefore, attach the ground lead to the base-to-display cable connector hardware or the ground terminal provided on the rear panel of the base unit.

---

**Task 2, Cut-off Points.** The second Task is to determine the cut-off points of the three cathodes. Use the following procedure to do so. When setting a raster to cut-off, check the upper left corner and all edges.

1. Turn all clamp and gain pots fully clockwise.
2. Display a Neapolitan (three-color) raster.
3. Set the screen grid pot so that each color is dim, but visible.
4. Display a step 1 red raster.
5. Turn the blue and green clamp pots fully counter-clockwise.
6. Adjust the red clamp pot to just barely extinguish the raster.
7. Measure and record the voltage on the red test point.
8. Display a step 1 green raster.
9. Turn the red and blue clamp pots fully counter-clockwise.
10. Adjust the green clamp pot to just barely extinguish the raster.
11. Measure and record the voltage on the green test point.
12. Display a step 1 blue raster.
13. Turn the red and green clamp pots fully counter-clockwise.
14. Adjust the blue clamp pot to just barely extinguish the raster.
15. Measure and record the voltage on the blue test point.

You now know which cathode has the low, middle and high cut-off voltage.

**Task 3, Screen Grid.** Set the voltage on the screen grid by using the following procedure:

1. Set the clamp pot for the low cut-off cathode fully clockwise.
2. Set the other two clamp pots fully counter-clockwise.
3. Leave the gain pots fully clockwise.
4. Display a black raster.
5. Adjust the screen grid pot to just barely extinguish the raster.

**Task 4, Low Cut-off.** Adjust the cathode with the low cut-off point with the following procedure:

---

**Note**

This procedure includes instructions for zeroing your photometer. If your meter has an auto-zero feature, skip steps 9 to 11. The Photodyne 19XE has the auto-zero feature.

---

1. Display a black raster.
2. Adjust the clamp pot to just cut-off the raster.
3. Measure and record the voltage on the test point for that clamp pot (call it V1).

**Note**

V1 will be 0V (clamp pot fully clockwise) on the first pass through the low cut-off gun.

4. Display a step 1 raster for the cathode being aligned.
5. Adjust the clamp pot to just cutoff the raster.
6. Measure and record the voltage on the test point for that clamp pot (call it V2).
7. Add V1 to V2 and divide by two. The resulting voltage is the desired one for the test point (call it Vset).
8. Set the clamp pot so that the test point reads Vset.
9. Temporarily unplug the display power cord. Leave the base plugged in. If your meter has the auto-zero feature, skip to step 12. The 19XE auto-zeros.
10. Place the photometer in the center of the CRT and zero it.
11. Reconnect the display power cord and confirm the black raster is still present.
12. Display a step 15 raster for the cathode being aligned.
13. Measure the brightness in the center of the screen.
14. Adjust the gain pot until you obtain the meter reading listed in this table:

Color	foot-lamberts		$\mu\text{W}/\text{M}^2\text{sr}^*$	
	50 Hz	60 Hz	50 Hz	60 Hz
red	4.4	5.2	.135	.160
green	11.2	12.8	.165	.195
blue	2.0	2.2	.180	.215

\*All values + or -.005.

15. Now repeat steps 4 through 14. This is necessary because the clamp and gain pots interact to a small degree. The pots should need only a small amount of adjustment. If any require a large amount, you have probably done something wrong.

**Task 5, Middle Cut-off.** Repeat Task 4 for the cathode with the middle cut-off.

**Task 6, High Cut-off.** Repeat Task 4 for the cathode with the high cut-off.

## ROM Addressing

The various ROM locations in the computer are addressed by a six digit hexadecimal number. The boot ROM is located between 000000 and 003FFF. Language and option ROMs are located between 020000 and 3FFFFFF. The ROM on the test stimulus board starts at 810000.

## Option ROM Board Addressing

The memory space between the boot ROM and address 400000 is dedicated to language and option ROM. This space is arranged in blocks of 128k bytes. For the sake of simplicity, the boot ROM is allotted a 128k byte block, although it is only 16k bytes in size. Since 128k bytes is 20000 in hexadecimal, there is room for 31 blocks, with the first block addressed from 020000 to 03FFFF (000000 to 01FFFF are allotted to the boot ROM) and succeeding blocks starting with multiples of 20000.

Each 128k byte ROM board contains one block. Each 512k byte ROM board contains four consecutive blocks, with the number of the first block being a multiple of four

## Checking an Option ROM Board Address

### 128k Byte ROM Board.

A five segment jumper location determines which of the 31 blocks a given board represents. The jumper location is a binary representation of the block number. A jumper present represents a zero and a jumper absent represents a one.

For instance, a ROM board has jumpers installed like this:

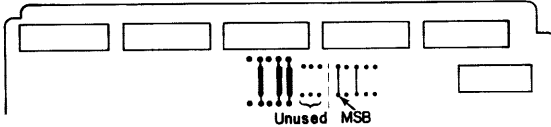

The jumpers read 01011. 01011 in binary converts to 0B in hexadecimal.

To determine the ROM address space occupied by a 128k byte board, multiply the block number by 20000 (hexadecimal). For instance, in the above example, B multiplied by 20000 is 160000. Therefore, this ROM board starts with address 160000 and ends with 17FFFF (one block).

An alternative to hexadecimal multiplication is to locate the jumper arrangement in this chart:

512k Byte Board Jumpers	Block	128k Byte Board Jumpers	Starting Address	Ending Address
	1	00001	020000	03FFFF
	2	00010	040000	05FFFF
	3	00011	060000	07FFFF
00100	4	00100	080000	09FFFF
	5	00101	0A0000	0BFFFF
	6	00110	0C0000	0DFFFF
	7	00111	0E0000	0FFFFF
01000	8	01000	100000	11FFFF
	9	01001	120000	13FFFF
	A	01010	140000	15FFFF
	B	01011	160000	17FFFF
01100	C	01100	180000	19FFFF
	D	01101	1A0000	1BFFFF
	E	01110	1C0000	1DFFFF
	F	01111	1E0000	1FFFFF
10000	10	10000	200000	21FFFF
	11	10001	220000	23FFFF
	12	10010	240000	25FFFF
	13	10011	260000	27FFFF
10100	14	10100	280000	29FFFF
	15	10101	2A0000	2BFFFF
	16	10110	2C0000	2DFFFF
	17	10111	2E0000	2FFFFF
11000	18	11000	300000	31FFFF
	19	11001	320000	33FFFF
	1A	11010	340000	35FFFF
	1B	11011	360000	37FFFF
11100	1C	11100	380000	39FFFF
	1D	11101	3A0000	3BFFFF
	1E	11110	3C0000	3DFFFF
	1F	11111	3E0000	3FFFFF

### 512k Byte ROM Board.

A five segment jumper/pull-up resistor location determines which four of the 31 blocks a given board represents. The jumper/resistor location is a binary representation of the number of the lowest address block. A jumper represents a zero and a pull-up resistor represents a one.

For instance, a ROM board has jumpers installed like this:

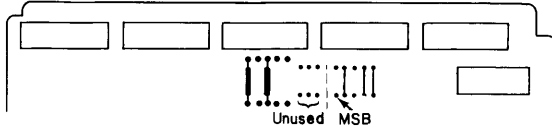

The segment location reads 10100. 10100 in binary converts to 14 in hexadecimal.

To determine the ROM address space occupied by a 512k byte board, multiply the block number by 20000 (hexadecimal). For instance, in the above example, 14 multiplied by 20000 is 280000. Therefore, this ROM board starts with address 280000 and ends with 2FFFFFF (four consecutive blocks).

An alternative to hexadecimal multiplication is to locate the jumper/resistor arrangement in the chart on the previous page.



**6-12** 9826/9836 Adjustments

# Chapter 7

## 9826/9836 Peripherals

### Peripherals Supported List

#### BASIC 2.0 Supported System Peripherals

Description	Interface Required
<b>Printers</b>	
2631B/G 180cps Dot Matrix Printer	Internal HP-IB or 98624A
2671A/G Serial Thermal Printer	Internal HP-IB or 98624A
2673A Intelligent Serial Thermal Printer	Internal HP-IB or 98624A
9866A/B Thermal Printer	98622A, Opt. 004
9876A Thermal Graphics Printer	Internal HP-IB or 98624A
82905A/B Dot Matrix Printer (graphics not supported)	Internal HP-IB or 98624A
<b>Digitizers</b>	
9111 Graphics Tablet	Internal HP-IB or 98624A
<b>Plotters</b>	
7225A/B Plotter with 17601A Personality Module	Internal HP-IB or 98624A
9872B/C/S/T 4 and 8-pen Plotters	Internal HP-IB or 98624A
7580A Eight-Color Drafting Plotter	Internal HP-IB or 98624A
<b>Mass Storage</b>	
9895A 8 in. Flexible Disc Drive	Internal HP-IB or 98624A
82900 Series 5¼ in. Flexible Mini-disc Drives	Internal HP-IB or 98624A
<b>Miscellaneous</b>	
6942A Multiprogrammer	Internal HP-IB or 98624A

#### HPL 2.0 Supported System Peripherals

Description	Interface Required
<b>Printers</b>	
2671A/G Serial Thermal Printer	Internal HP-IB or 98624A
9876 Thermal Graphics Printer	Internal HP-IB or 98624A
2631B/G 180cps Dot Matrix Printer	Internal HP-IB or 98624A
9866A/B Thermal Printer	98622A, Opt. 004
82905A/B Dot Matrix Printer (graphics not supported)	Internal HP-IB or 98624A
<b>Plotters</b>	
9872C Eight-color Plotter	Internal HP-IB or 98624A
7225A/B Plotter with 17601A Personality Module	Internal HP-IB or 98624A
7580 Eight-color Drafting Plotter	Internal HP-IB or 98624A
<b>Digitizers</b>	
9111A Graphics Tablet	Internal HP-IB or 98624A
<b>Mass Storage</b>	
9885M Flexible Disc Drive	98622A, Opt. 002 and 98620A
9895 Flexible Disc Drive	Internal HP-IB or 98624A, 98620A is optional
82900 Series Mini-disc drives	Internal HP-IB or 98624A, 98620A is optional
<b>Miscellaneous</b>	
6942A Multiprogrammer	Internal HP-IB or 98624A

#### Pascal Supported System Peripherals

Description	Interface Required
<b>Printers</b>	
2631G Graphics Printer	Internal HP-IB or 98624A
2673A Serial Thermal Printer	Internal HP-IB or 98624A
9876A Thermal Graphics Printer	Internal HP-IB or 98624A
<b>Mass Storage</b>	
9885M/A Flexible Disc Drive	98622A, Opt. 002 and 98620A
9895A Flexible Disc Drive	Internal HP-IB or 98624A

## Peripherals

Product No. (Opt. Included)	Description	Language Support		
		BASIC	HPL	Pascal
<b>Printers</b>				
2601A Opt. 826*	Letter Quality Daisy Wheel Printer	1.0	1.0	2.1
2602A Opt. 046	Letter Quality Daisy Wheel Printer	1.0	1.0	2.0
2631B/G	Serial Impact Graphics Printer	1.0	1.0	1.0
2671B/G†	Serial Thermal Graphics Printer	1.0	1.0	1.0
2673C†	Intelligent Serial Thermal Graphics Printer	1.0	1.0	1.0
9876A	Thermal Graphics Printer	1.0	1.0	1.0
82905A/B Opt.002†‡	Serial Impact Printer	1.0	1.0	1.0
<b>Plotters‡</b>				
9872C	Eight-pen Plotter	1.0	1.0	1.0
9872T	Eight-pen Plotter	1.0	1.0	1.0
7470A Opt. 002	Two-pen Graphics Plotter	1.0	1.0	1.0
7580A	Eight-pen D/A1-size Drafting Plotter	1.0	1.0	1.0
7585B	Eight-pen E/A0-size Drafting Plotter	1.0	1.0	2.0
<b>Tablet‡</b>				
9111A**	Graphics Tablet	2.0	—	1.0
<b>Mass Storage</b>				
9885M*	8-in. Flexible Disc Drive (Master)	2.0††	1.0	1.0
9885S*	8-in. Flexible Disc Drive (Slave)	2.0††	1.0	1.0
9895A	8-in. Dual Flexible Disc Drive (2.4M byte)	2.0††	1.0	1.0
82901M	5¼-in. Dual Flexible Disc Drive (Master) (540K byte)	2.0††	1.0	2.0
82902M	5¼-in. Flexible Disc Drive (Master) (240K byte)	2.0††	1.0	2.0
9121S	3½-in. Single Flexible Disc Drive (270K byte)	2.0††	1.0	2.0
9121D	3½-in. Dual Flexible Disk Drive (540K byte)	2.0††	1.0	2.0
9133A	Combination 3½-in. Flexible Disc (270K byte) and 5¼-in. Winchester Disc Drive (4.6M byte)	2.0††	1.0	2.0
Opt. 010	4.8M byte Winchester	2.0††	—	2.0
9133B	Combination 3½-in. Flexible Disc (270K byte) and 5¼-in. Winchester Disc Drive (9.7M byte)	2.0††	—	2.0
9134A	5¼-in. Winchester Drive (4.6M byte)	2.0††	1.0	1.0
Opt. 010	4.8M byte Winchester	2.0††	—	2.0
9134B	5¼-in. Winchester Drive (9.7M byte)	2.0††	—	2.0
9135A	Combination 5¼-in. Flexible Disc (270K byte) and 5¼-in. Winchester Drive (4.6M byte)	2.0††	1.0	2.0
Opt. 010	4.8M byte Winchester	2.0††	—	2.0
7908P	16.5M byte Fixed Disc	2.0††	—	2.0
7911P	28.1M byte Fixed Disc	2.0††	—	2.0
7912P	65.6M byte Fixed Disc	2.0††	—	2.0
<b>External Monitors (Model 20 only)</b>				
82913A	12-in. (305mm) CRT Display	N/A	N/A	N/A
Opt. 001	230V (Europe)			
Opt. 002	100V (Japan)			
82912A	9-in. (229mm) CRT Display	N/A	N/A	N/A
Opt. 001	230V (Europe)			
<b>Miscellaneous</b>				
1360S	Graphics Display System*	N/A	N/A	N/A

\* Not supported on the Model 16 or Model 20.

† Not supported in a Pascal development environment.

‡ Specify Opt. 026 when ordering Model 16 or 26 and Opt. 036 when ordering Model 36.

§ Graphics not supported.

\*\* Needs a dedicated HP-IB device to optimize cursor tracking. Also, when running BASIC, requires BASIC Extensions 2.1.

†† Requires BASIC Extensions 2.1.

‡‡ Although BASIC 2.0 is recommended, BASIC 1.0 customers can use the peripheral with the BASIC Enhancements Binary (BEB) present. However, this is not recommended, as BASIC 2.0 contains all BASIC 1.0 and BEB capabilities and more, and BEB is no longer a supported product.

# Chapter 8

## 9826/9836 Replaceable Parts

### 9826 Exploded View

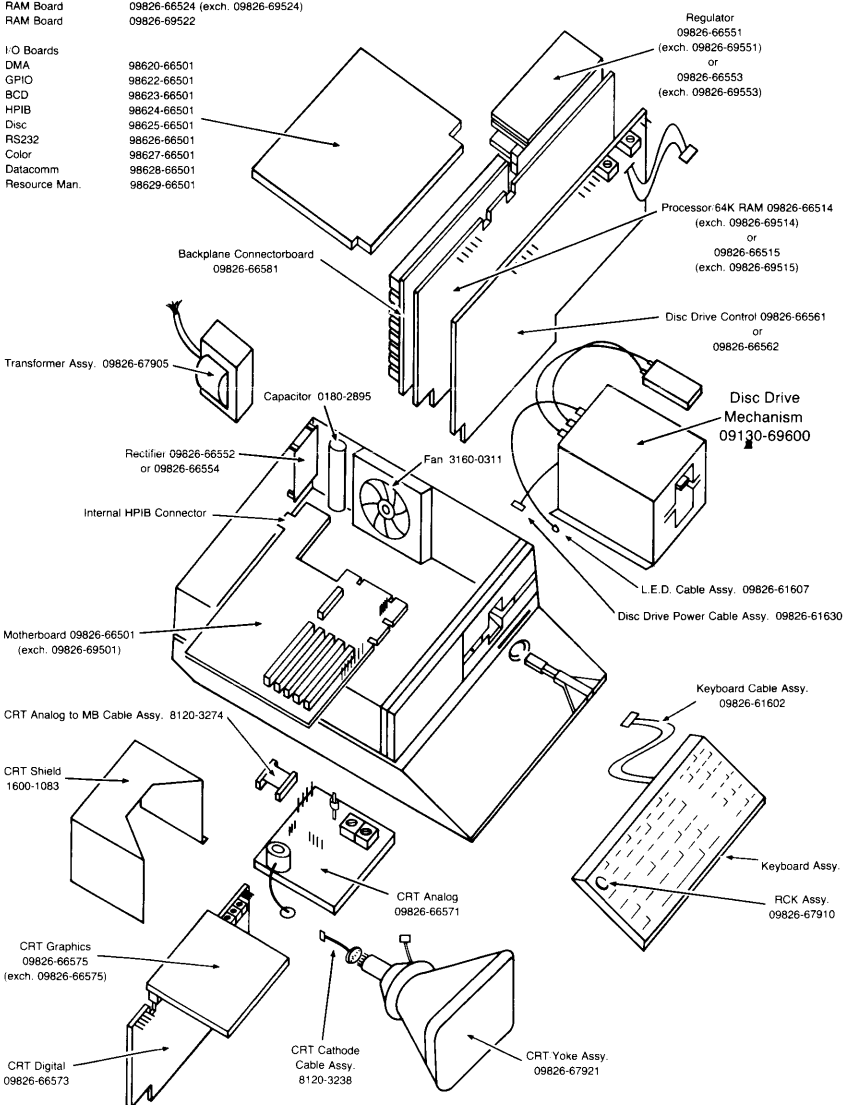

# 9836A Exploded View

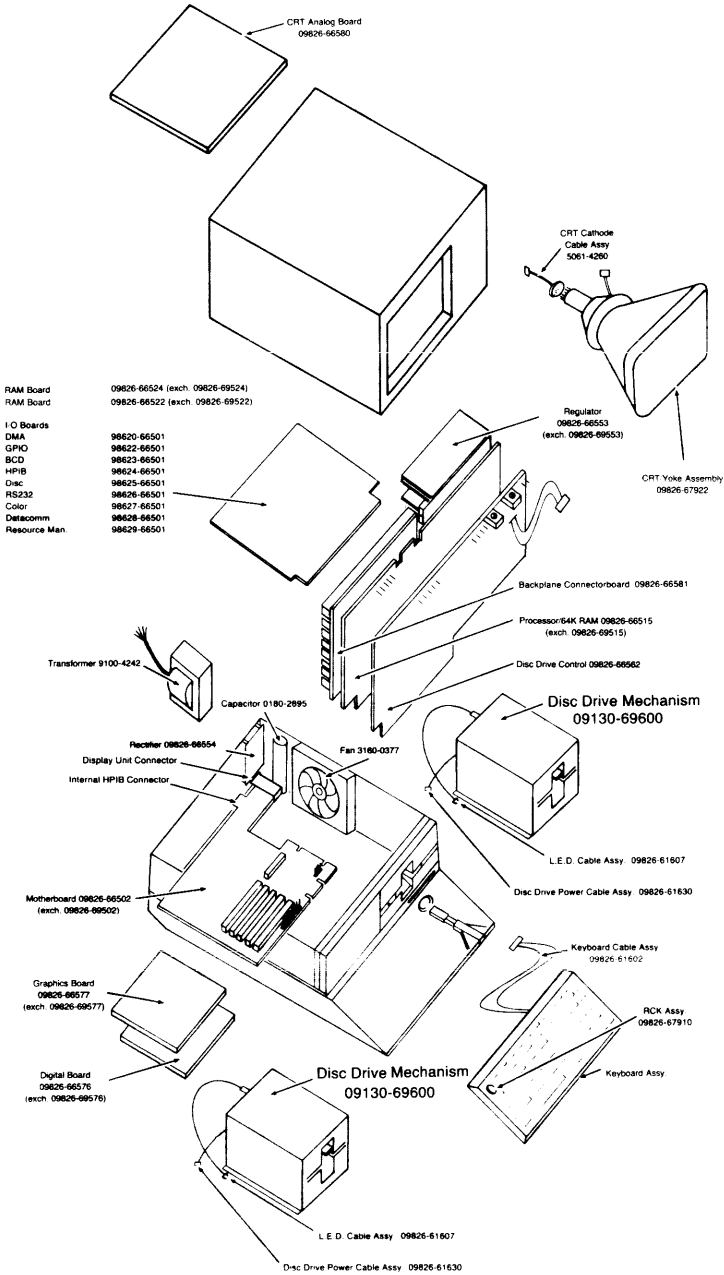

# 9836C Exploded View

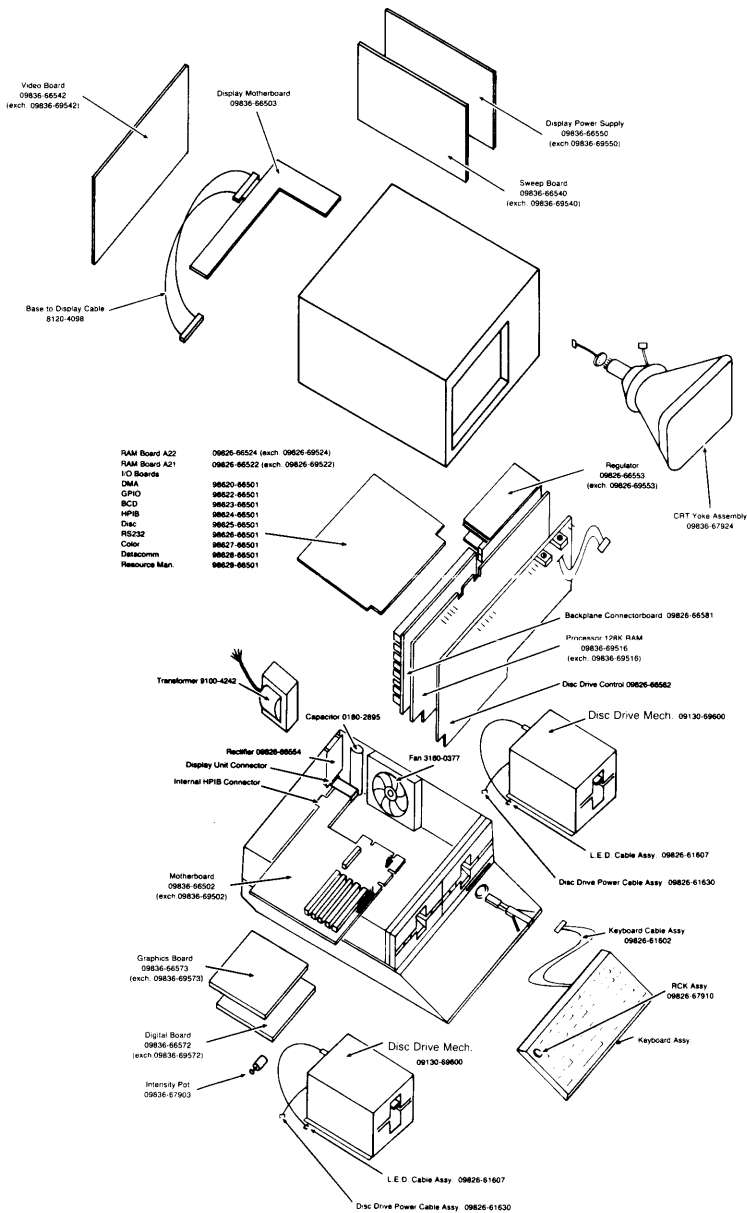

## 9826/9836 Exchange Assemblies

Reference Designator	CD	HP Part No.	TQ	Description
	2	09826-69501	1	Motherboard (9826)
	3	09826-69502	1	Motherboard (9836)
	4	09826-69511	1	Processor board (9826)
	7	09826-69514	1	Processor and 64k RAM (9826)
	8	09826-69515	1	Processor and 64k RAM
	7	09826-69522		64k RAM board
	9	09826-69524		256k RAM board
	2	09826-69551	1	Regulator board (9826)
	4	09826-69553	1	Regulator board
	0	09826-69575	1	CRT graphics board (9826)
	2	09826-69577	1	CRT graphics board (9836)
	1	09130-69600	1	Disc drive mechanism
	6	09826-69555		Powerfail Real-Time Clock Board
	1	09826-69576	1	CRT digital board (9836)

## 9826/9836 Non-exchange Assemblies

Reference Designator	CD	HP Part No.	TQ	Description
	7	09826-66552	1	Rectifier board (9826)
		09826-66554	1	Rectifier board
	8	09826-66561	1	Disc drive control board (9826)
	5	09826-66562	1	Disc drive control board
	2	09826-66573	1	CRT digital board (9826)
	0	09826-66571	1	CRT analog board (9826)
	8	09826-66580	1	CRT analog board (9836)
	2	09826-66581	1	Backplane connectorboard
	6	09826-67921	1	CRT yoke assembly (pincushioned) (9826)
	7	09826-67922	1	CRT yoke assembly (pincushioned) (9836)
	3	09826-67910	1	Rotary control knob assembly
	0	9100-4140	1	Transformer assembly (9826)
	3	9100-4242	1	Transformer assembly (9836)
	7	0180-2895	1	Capacitor assembly
	9	3160-0311	1	Ac Fan assembly (9826)
	7	3160-0377	1	Dc Fan assembly (9836)
	6	09826-68002		Standard keyboard (old tooling)
	8	09826-68012		Standard keyboard (new tooling)
	7	09826-68003		Option 810 keyboard (old tooling)
	9	09826-68013		Option 810 keyboard (new tooling)
	1	09826-68007		Option 820 keyboard (old tooling)
	3	09826-68017		Option 820 keyboard (new tooling)
	2	09826-68008		Option 830 keyboard (old tooling)
	4	09826-68018		Option 830 keyboard (new tooling)
	0	09826-68006		Option 840 keyboard (old tooling)
	2	09826-68016		Option 840 keyboard (new tooling)
	9	09826-68005		Option 850 keyboard (old tooling)
	1	09826-68015		Option 850 keyboard (new tooling)
	4	09826-90300		Option ROM Boards
	0	09836-66503	1	Display Motherboard
	1	09836-67924	1	CRT Yoke Assembly
	4	3160-0209	1	Display Fan
	8	8120-4098	1	Base-to-display Cable

## Part Numbers for New Exchange Assemblies

Reference Designator	CD	HP Part No.	TQ	Description
	6	09826-66501	1	Motherboard (9826)
	7	09826-66502	1	Motherboard (9836)
	6	09826-66551	1	Regulator board (9826)
	8	09826-66553	1	Regulator board
	5	09130-66600		Disc drive mechanism
	4	09826-66575	1	CRT graphics board (9826)
	6	09826-66577	1	CRT graphics board (9836)
	5	09826-66576	1	CRT digital board (9836)
	0	09826-66555	1	Powerfail Real-Time Clock board
	8	09826-66511	1	Processor board (9826)
	1	09826-66514	1	Processor and 64k RAM (9826)
	2	09826-66515	1	Processor and 64k RAM
	1	09826-66522		64k RAM board
	3	09826-66524		256k RAM board
	9	09826-66516	1	Processor Board
	3	09836-66502	1	Base Motherboard
	9	09836-66540	1	Sweep Board
	1	09836-66542	1	Video Board
	1	09836-66550	1	Display Power Supply
	7	09836-66572	1	Digital Board
	8	09836-66573	1	Graphics Board

## Miscellaneous Items

Reference Designator	CD	HP Part No.	TQ	Description
	8	6010-0695		Touch-up paint (Pearl grey)
	2	09130-67910		Disc drive shipping carton
	5	9211-3621		CRT shipping carton (9826)
	2	9220-2209		CRT shipping pad (9826)
	1	9220-3462		CRT shipping pad (9826)
	2	09836-80000		TSB update ROMs
	5	9222-0682		Anti-static bags
	5	9300-0933		Anti-static workstation
	3	92193A		Head cleaning kit
		8500-2163		CRT window cleaner

## Standard ASCII Keyboard Assembly

Keypad part number is 0371-XXXX.

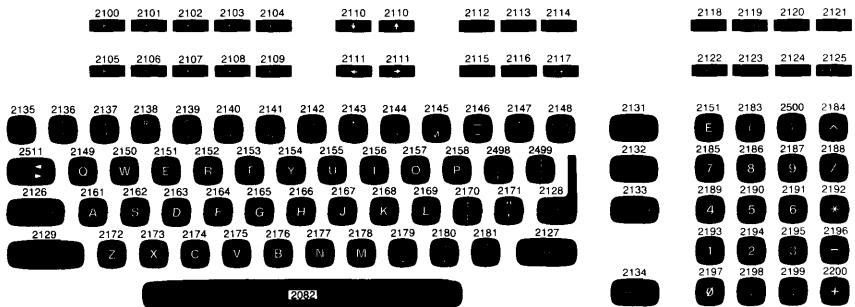



## Option 810, French Keyboard Assembly

Keycap part number is 0371-XXXX.

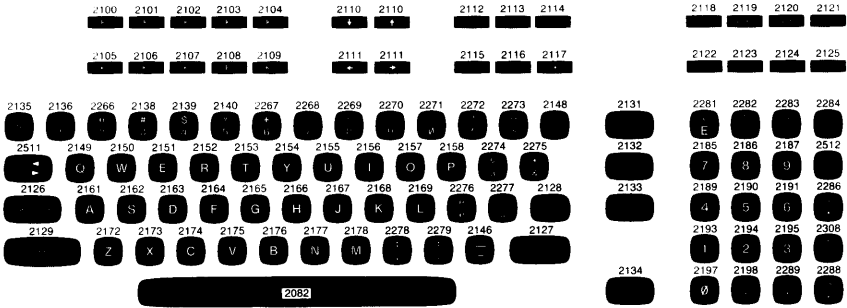

## Option 820, Spanish Keyboard Assembly

Keycap part number is 0371-XXXX.

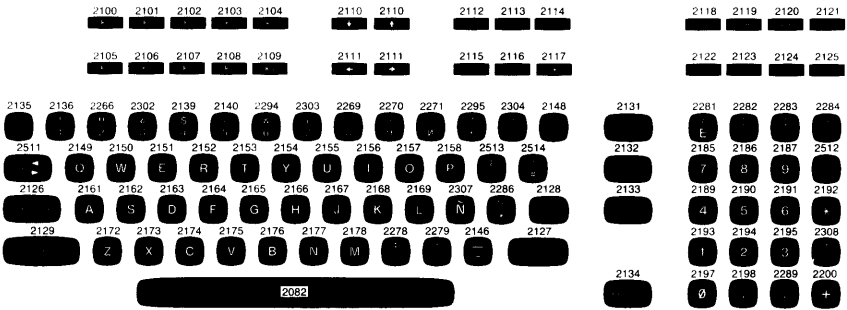

## Option 830, German Keyboard Assembly

Keycap part number is 0371-XXXX.

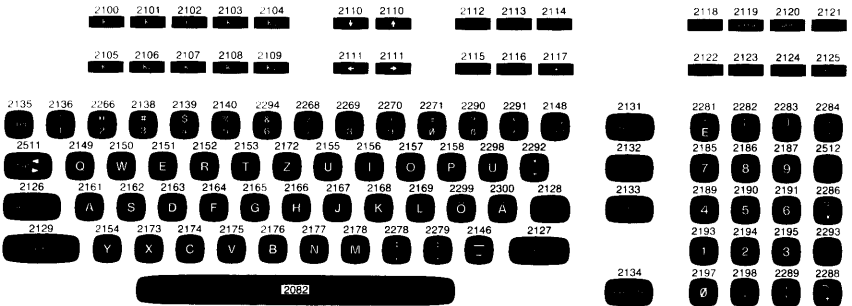

## Option 840, Jananese Kana Keyboard Assembly

Keycap part number is 0371-XXXX.

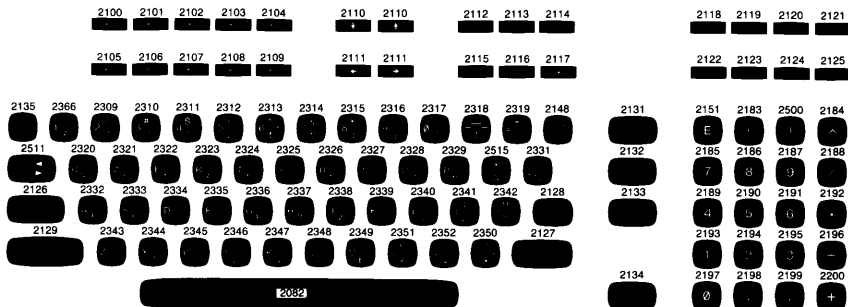

## Option 850, Swedish/Finnish Keyboard Assembly

Keycap part number is 0371-XXXX.

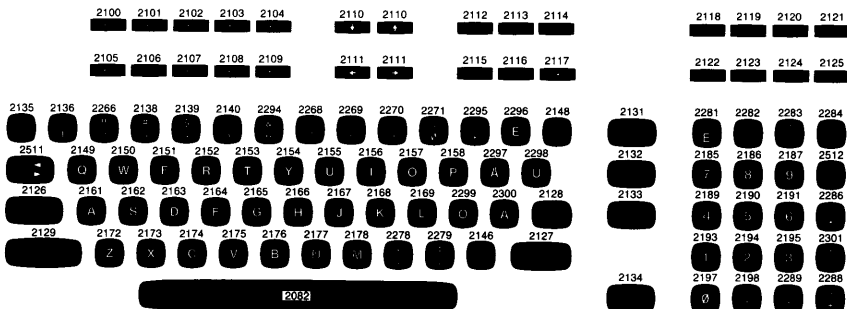

## 9826 Case Hardware Part Numbers

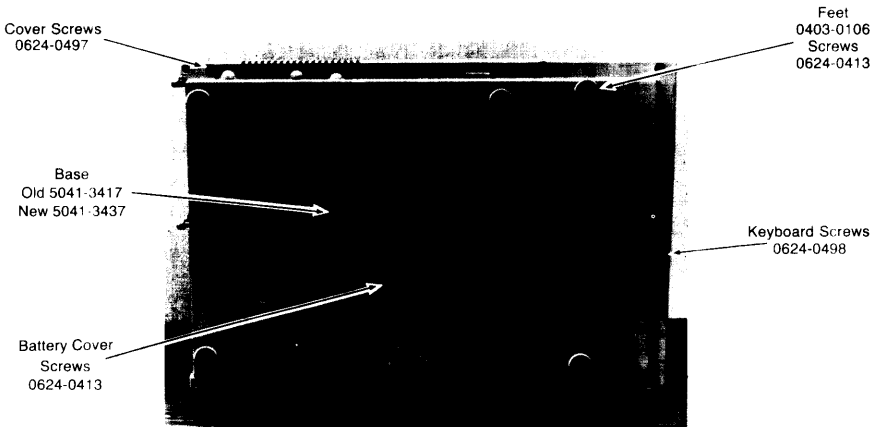
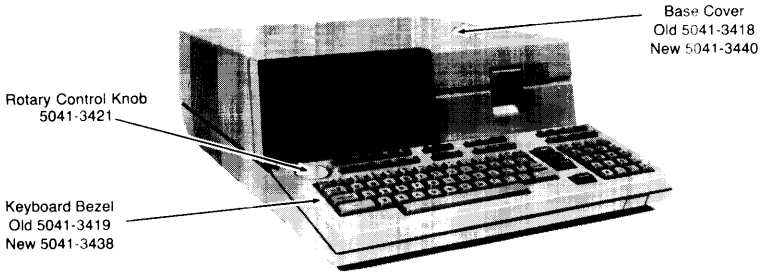

# 9826 Case Hardware Part Numbers (Continued)

Keyboard  
 Screws 0624-0410  
 Washers 2190-0008

Rotary Control Knob  
 Nut 2950-0001  
 Washer 3050-0067  
 Lock Washer 2190-0016

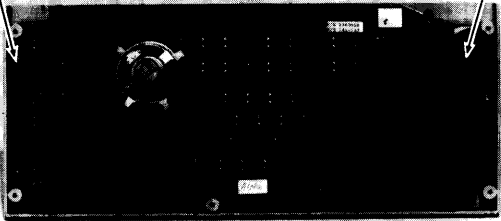

LED  
 09826-61607

CRT Window  
 Old 4040-1884  
 New 4040-2092

Screws  
 0624-0499

CRT Bezel  
 Old 5041-3420  
 New 5041-3439

Screws  
 0624-0497

Power Switch  
 3101-2452  
 Switch Housing  
 3131-0452  
 Switch Button  
 3131-0448  
 Warning Label  
 7120-4559  
 Screws  
 0624-0408

Keyboard Cable  
 09826-61602

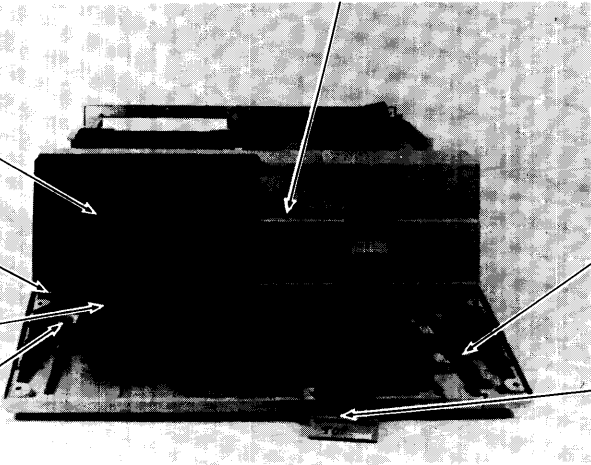

## 9826 Case Hardware Part Numbers (Continued)

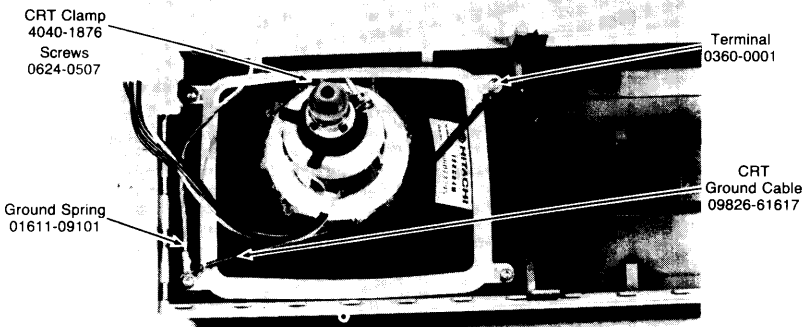
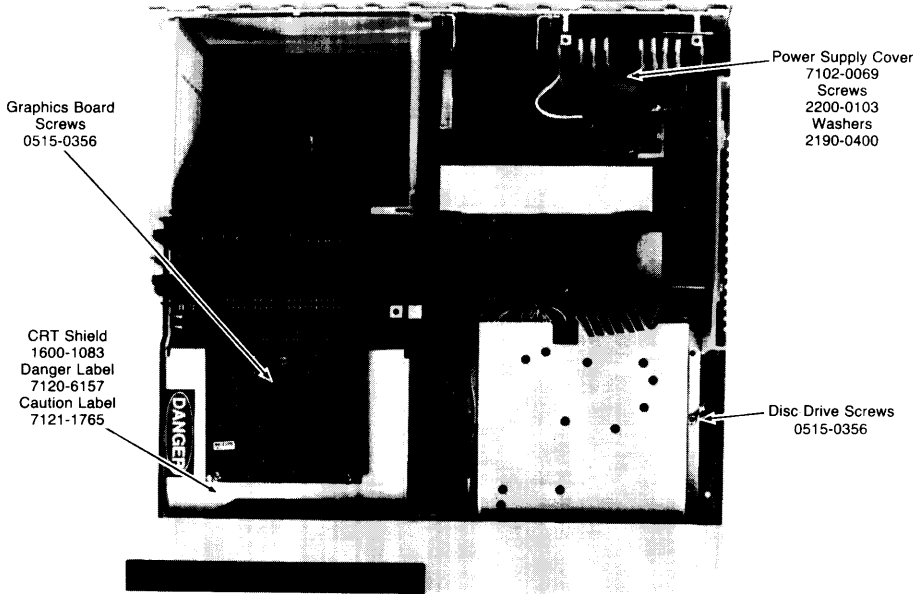

## 9826 Case Hardware Part Numbers (Continued)

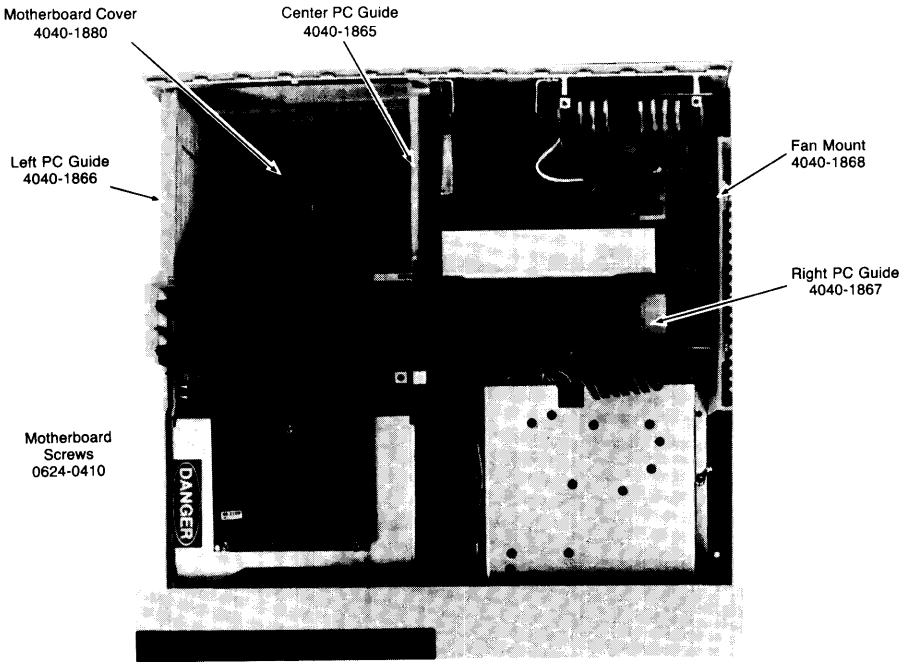

### PC Guide Hardware:

Fasten to base with:

Screw 0624-0499

Fasten to rear panel with:

Screw 0624-0472

### Fan Hardware:

Long Screws 0624-0473

Ground Connection Screw 2510-0099

Washer 3050-0066

## 9826 Case Hardware Part Numbers (Continued)

Rear Sub-Panel  
Old 1600-1082  
New 1600-1196

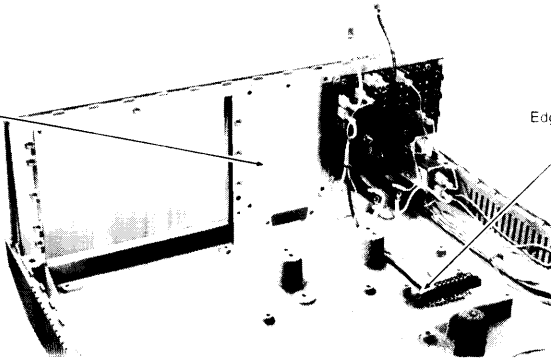

Edge Connector Screws  
0624-0281

Sub-Panel Screws  
0515-0305  
Line Filter Nut  
0535-0028

Transformer Screws  
Rear Panel  
0624-0472  
Base  
0624-0497

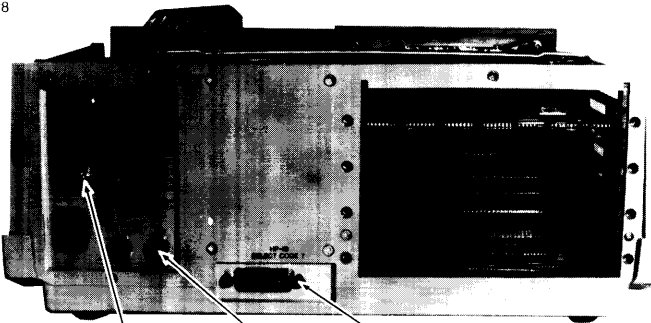

Rectifier Board  
Screw  
0515-0356

Fuse Holder Nut  
2110-0569  
Cap  
2110-0565

HP-IB  
Screws  
0380-1332  
Washer  
2190-0577

## 9836A Case Hardware Part Numbers

Keyboard  
Screws 0624-0410  
Ground Washer 2190-0008

Rotary Control Knob  
Nut 2950-0001  
Flat Washer 3050-0067  
Star Washer 2190-0016

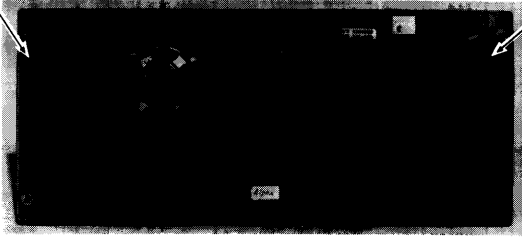

Base  
5041-3437

Screws  
0624-0497

Power Switch 3101-2452  
Switch Housing 3131-0452  
Switch Button 3131-0448  
Warning Label 7120-4559  
Screws 0624-0408

Keyboard Cable  
09826-61602

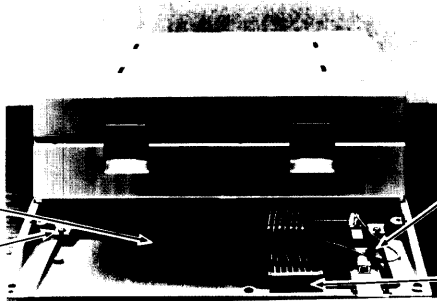



## 9836A Case Hardware Part Numbers (Continued)

Rotary Control Knob  
5041-3421

Base Cover  
5041-3441

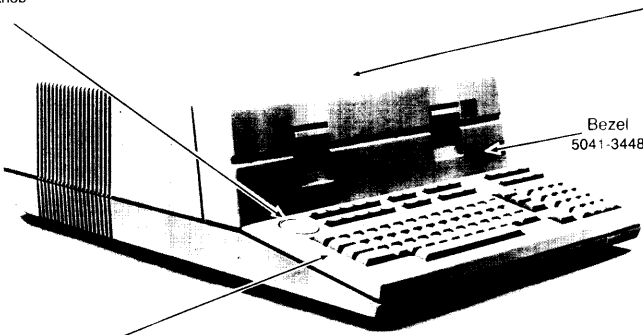

Bezel  
5041-3448

Keyboard Bezel  
5041-3438

Cover Screws  
0624-0497

Feet  
0403-0106  
Screws  
0624-0413

Base  
5041-3437

Keyboard Screws  
0624-0498

Battery Cover  
Screws  
0624-0413

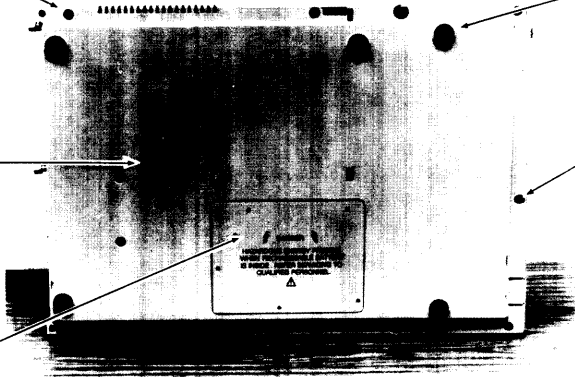

## 9836A Case Hardware Part Numbers (Continued)

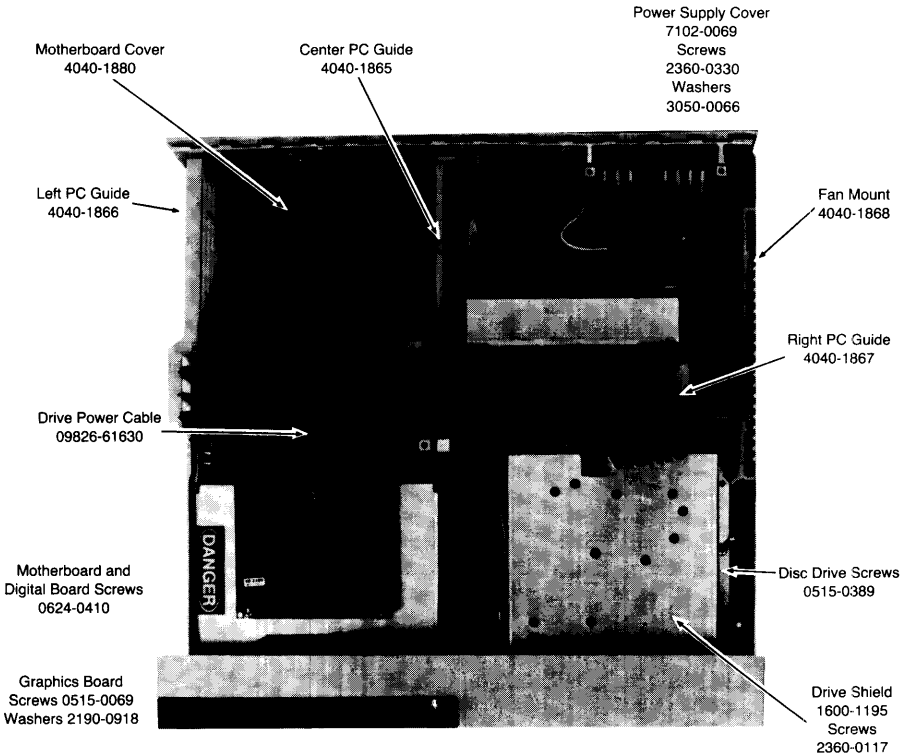

### PC Guide Hardware:

Fasten to base with:  
 Screw 0624-0499  
 Fasten to real panel with:  
 Screw 0624-0472

### Fan Hardware:

Long Screws 0624-0473  
 Base Screw 0624-0499  
 Ground Connection Screw 2510-0099

## 9836A Case Hardware Part Numbers (Continued)

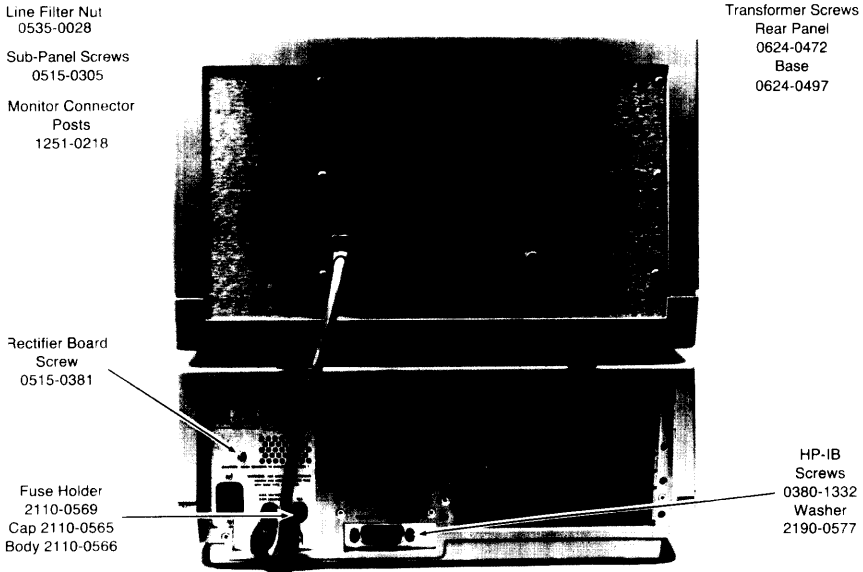
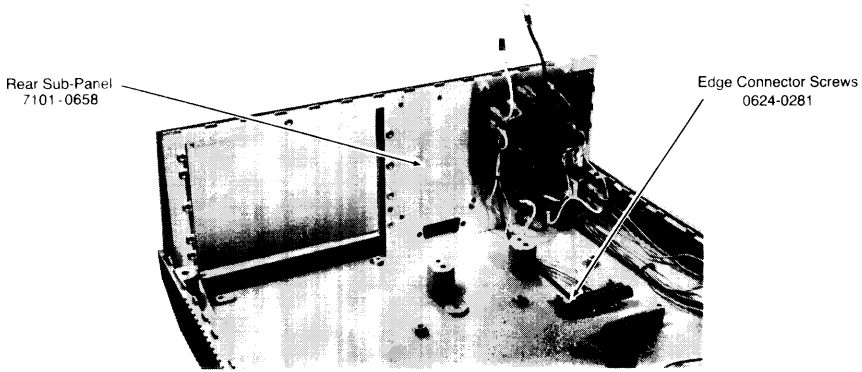

# 9836A Case Hardware Part Numbers (Continued)

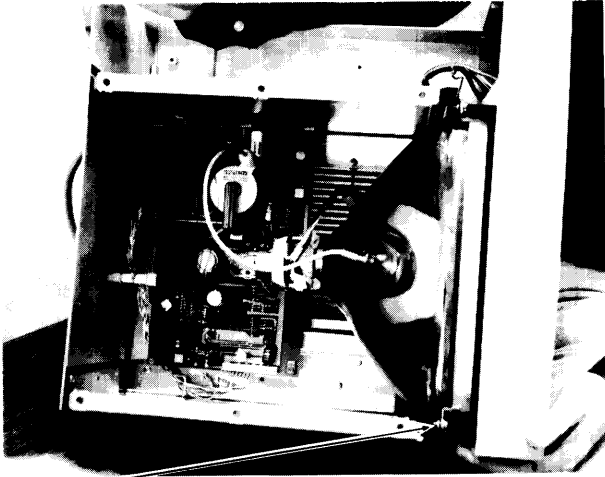

Interconnect Cable  
Clip  
1600-1157  
Ground Screw  
0515-0389

Intensity Pot Assembly  
09836-67902  
Washer  
2190-0027  
Nut  
2950-0006  
Knob  
0370-1121

**CRT**

Screws 0515-0389  
Bushings 0340-0500  
Metal Washers 3050-0257  
Plastic Washers 2190-0860

Analog Board Screws  
0515-0389

CRT Cover  
5041-3445  
Fasteners 1390-0594  
Clips 1390-0088

CRT Window  
1000-0640  
Screws  
0624-0410  
Clamp  
4040-0251

CRT Bottom  
5041-3443  
Screws  
0624-0458

CRT Bezel  
5041-3444  
Screws  
0624-0458

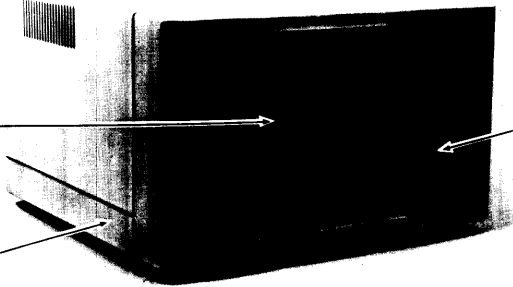

## 9836C Case Hardware Part Numbers

Keyboard  
Screws 0624-0410

Rotary Control Knob  
Nut 2950-0001  
Flat Washer 3050-0067  
Star Washer 2190-0016

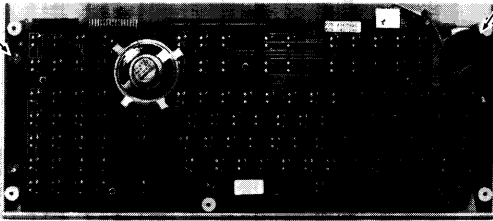

Screws  
0624-0497

Base  
5041-3437

Power Switch 3101-2452  
Switch Housing 3131-0452  
Switch Button 3131-0448  
Warning Label 7120-4559  
Screws 0624-0408

Keyboard Cable  
09826-61602

Base Cover  
5041-3441

Bezel  
09836-40802 (w/o Logo)  
5041-3448 (w Logo)

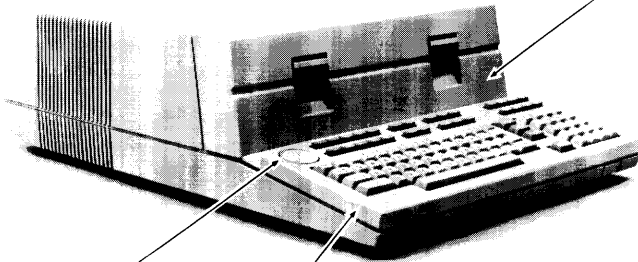

Rotary Control Knob  
5041-3421

Keyboard Bezel  
5041-3438

## 9836C Case Hardware Part Numbers (Continued)

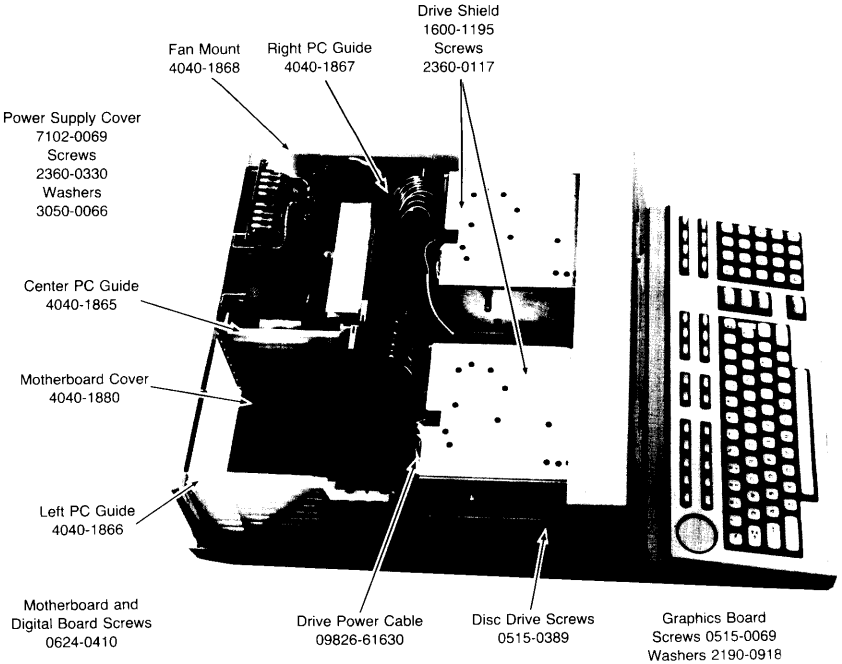
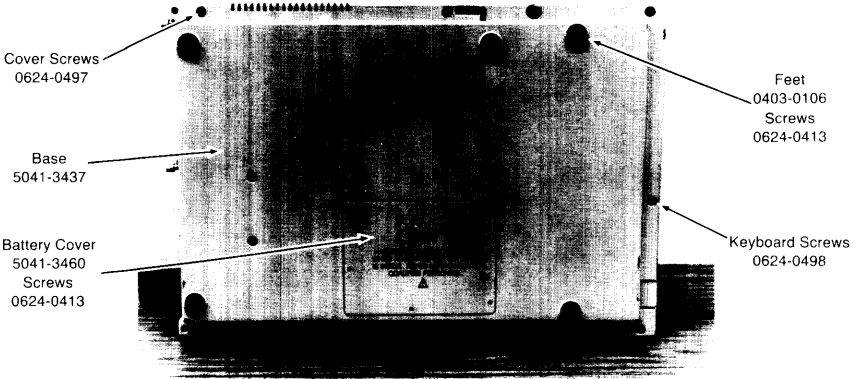

**PC Guide Hardware:**

Fasten to base with:  
Screw 0624-0499  
Fasten to rear panel with:  
Screw 0624-0472

**Fan Hardware:**

Long Screws	0624-0559
Base Screw	0624-0499
Ground Connection Screw	2510-0099

## 9836C Case Hardware Part Numbers (Continued)

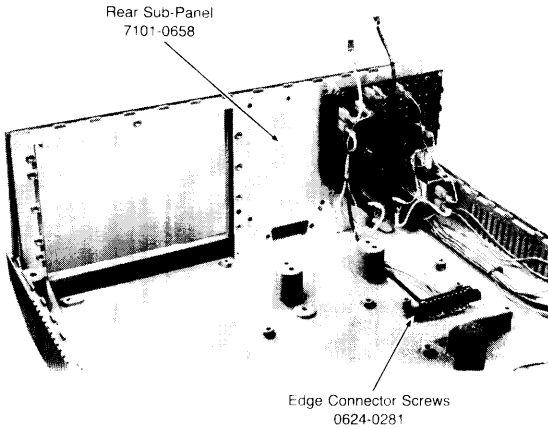

Line Filter Nuts  
0535-0028

Sub-Panel Screws  
0515-0305

Monitor Connector  
Posts  
1251-0218

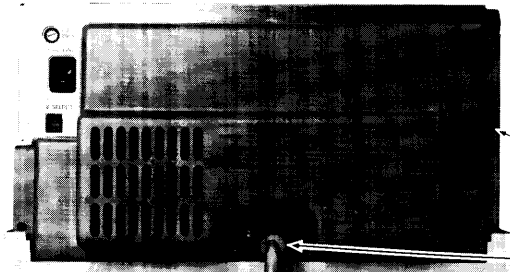

Fan 98760-67901  
Boot 4040-1926  
Cover 7101-0770  
Snap-ins 1390-0444

Cable  
8120-4098  
Clip  
1251-0220

Rectifier Board  
Screw  
0515-0381

Fuse Holder  
2110-0569  
Cap 2110-0565  
Body 2110-0566

Clip  
1251-0220

HP-IB  
Screws  
0380-1332  
Washer  
2190-0577

Transformer Screws  
Rear Panel  
0624-0472  
Base  
0624-0497

## 9836C Case Hardware Part Numbers (Continued)

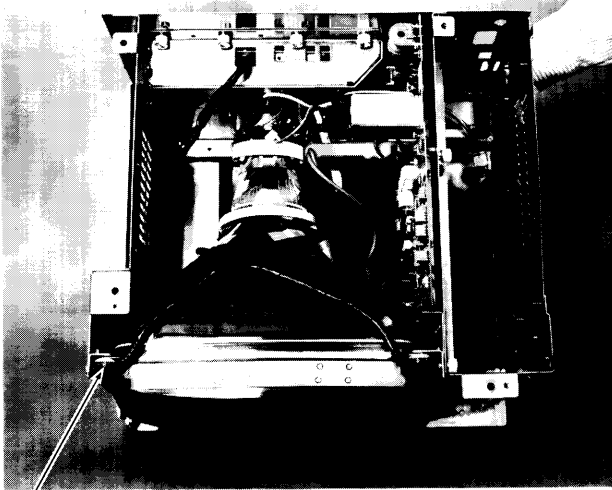

CRT

### New Video Board Fasteners

Screws 0515-0389  
 Bushings 0340-0500  
 Metal Washers 3050-0257  
 Nylon Washers 2190-0860  
 Nut 0535-0004  
 Insulator 1200-0081  
 Spring 1460-1915  
 Spring Washer 0360-0005

Screws 0515-0825  
 Spacers 0380-1579  
 Nuts 0535-0043

Interconnect Cable  
 8120-4098

CRT Window  
 1000-0640  
 Screws  
 0624-0410  
 Clamp  
 4040-0251

CRT Cover  
 5041-3445  
 Fasteners 1390-0594  
 Clips 1390-0088

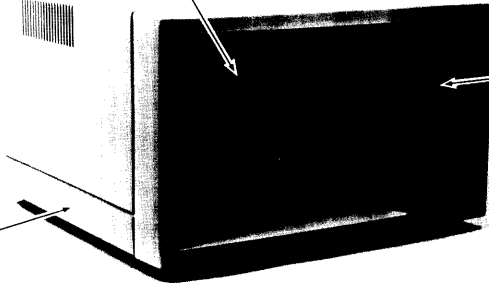

CRT Bottom  
 5041-3443  
 Screws  
 0624-0458

CRT Bezel  
 09836-40801 (w Logo)  
 5041-3444 (w o Logo)  
 Screws  
 0624-0458  
 Bracket  
 1600-1384  
 Screws  
 0515-0052  
 Star Washers  
 2190-0028  
 Flat Washers  
 3050-0803



## 9836C Case Hardware Part Numbers (Continued)

Slider 1600-1244  
Screw 0515-0222  
Plastic Washer 3050-1057  
Metal Washer 3050-0010

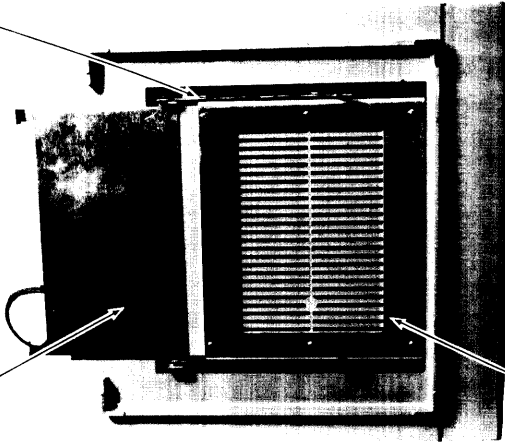

Handle 1440-0161  
Screw 0515-0389

Carriage 1600-1241  
Screws 0624-0458

CRT  
Screws 0515-0389  
Bushings 0340-0500  
Metal Washers 3050-0257  
Nylon Washers 2190-0860  
Nut 0535-0004  
Insulator 1200-0081  
Spring 1460-1915  
Spring Washer 0360-0005

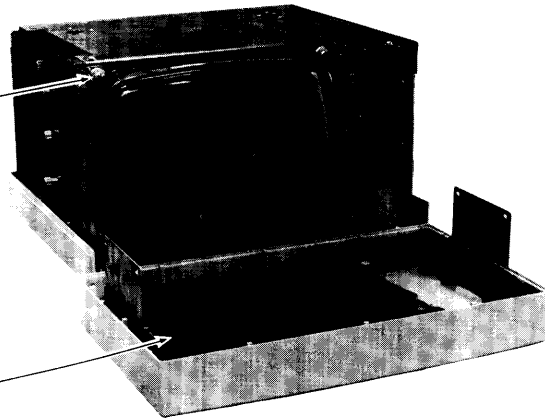

Dust Gasket 09836-46700  
Clamp 09836-41200

# Chapter 9

## 9826/9836 Diagrams

### 9826 Simplified Block Diagram

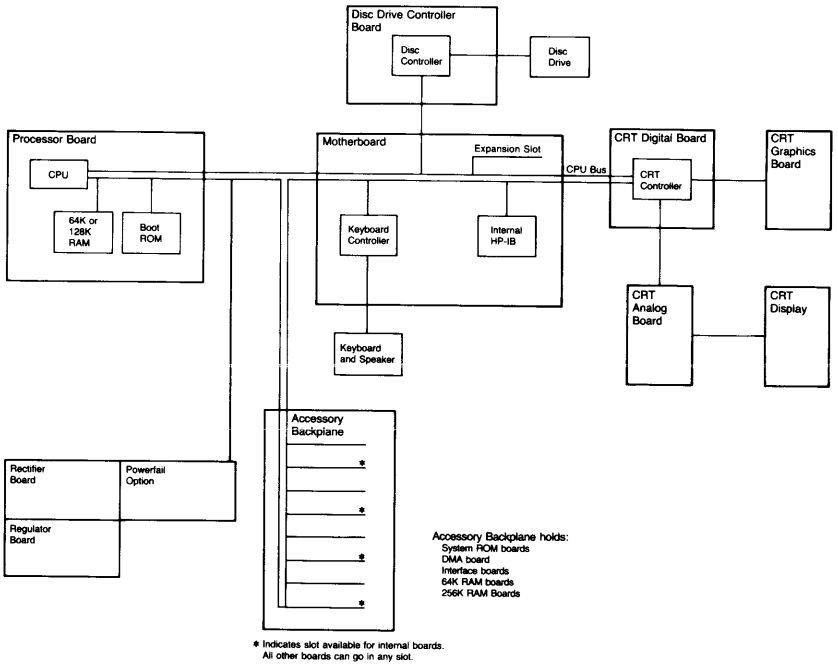

# 9836A Simplified Block Diagram

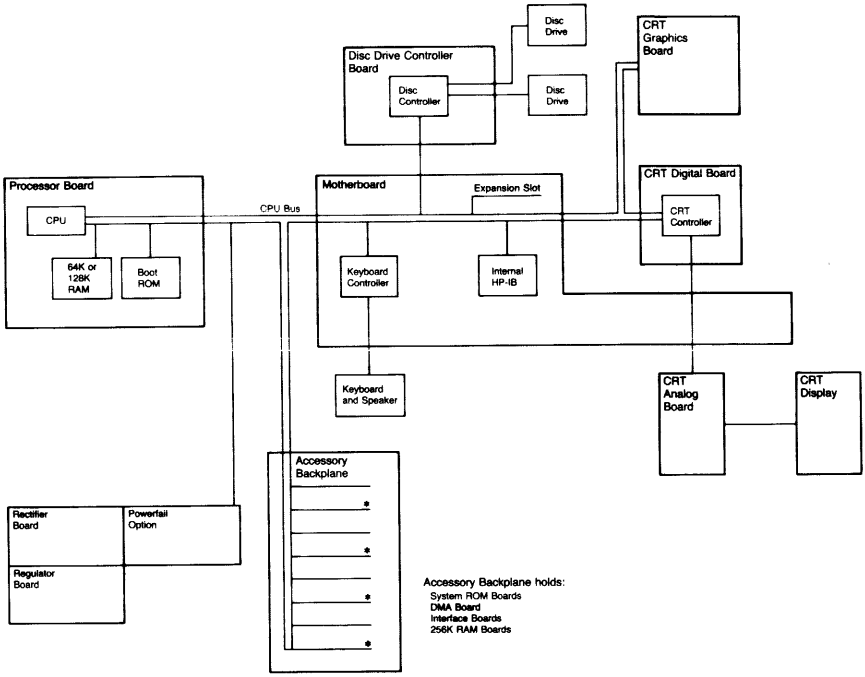

Accessory Backplane holds:  
 System ROM Boards  
 DMA Board  
 Interface Boards  
 256K RAM Boards

• Indicates slot available for internal boards.  
 All other boards can go in any slot.

# 9836C Simplified Block Diagram

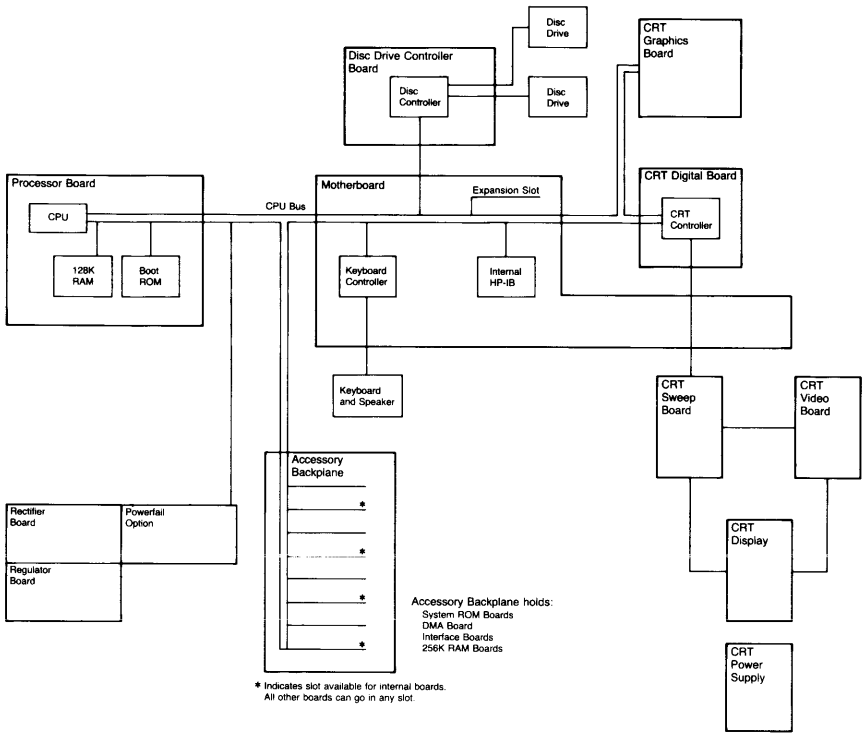

## Assembly Functions

### Processor Board

1. CPU, 64k RAM, Boot ROM
2. 23 address lines
3. 16 data lines
4. 7 interrupt lines
5. 17 control/handshake lines
6. 8 MHz clock

### Motherboard

1. Internal HP-IB (SC7)
2. Keyboard, RCK, beeper
3. Real-time clock
4. 10 Mhz clock
5. Chip select for
  - a. CRT alpha
  - b. CRT graphics
  - c. Keyboard
  - d. Internal HP-IB
  - e. Disc drive
  - f. Powerfail option

### Disc Drive Controller Board

1. Read, write interfacing
2. Margin testing
3. Freerun, margin adjust

### Video Board

1. Red, green, blue amplifiers
2. Intensity adjustments

### Sweep Board

1. High voltage generator/flyback
2. Horizontal drive
3. Spark protection
4. Vertical ramp and drive
5. Focus, width, height, centering adjust
6. Screen grid adjust

### CRT Digital Board

1. Character ROM
2. CRT controller IC
3. Vertical ramp and drive (9826 only)
4. Alpha/graphics mixer
5. Position, height adjust (9826 only)

### CRT Graphics Board

1. Graphics RAM
2. Graphics refresh

### CRT Analog Board

1. High voltage generator/flyback
2. Half/full video amp
3. Horizontal drive
4. Spark protection
5. Width, intensity, focus adjust
6. Vertical ramp and drive (9836A only)
7. Size, horizontal position, vertical linearity adjust (9836A only)

### Power Supply

1. -12, +12, +5V supply/adjust
2. Overcurrent protection
3. +5, +12V overvoltage protection
4. Power-up reset signal

### Display Power Supply

1. -12, +5, +12 and +75V supply
2. +75V overvoltage protection
3. Power-up reset signal

## Keyboard Row and Column Diagram

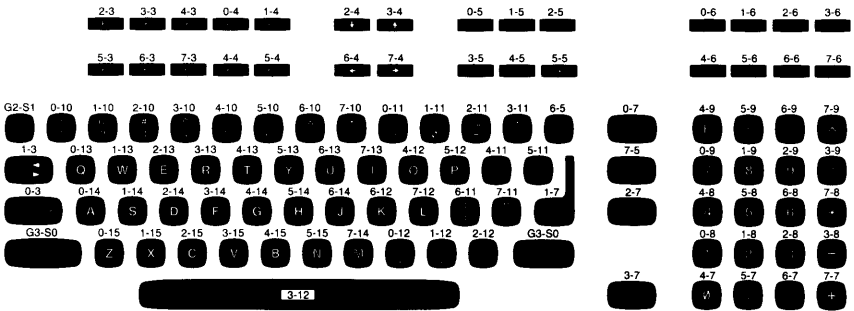

## Keycode Matrix Diagram

COLUMN		ROW															
		0	1	2	3	4	5	6	7	8	9	10	11	12	13	14	15
ROW	0	French	RCK Reset	J1	CAPS LOCK 1B	K3 20	INS LN 2B	EDIT 30	PAUSE 3B	1 40	7 4B	1 50	(9 5B	< 60	Q 6B	A 70	Z 7B
	1	German		J2	TAB 1B	k4 21	DEL LN 2B	ALPHA 31	ENTER 3B	2 41	8 4B	@ 51	J* 5B	> 61	W 6B	S 71	X 7B
	2	SW/F		J3	k0 1A	1 22	RECALL 2A	GRAPH 32	CONT 3A	3 42	9 4A	# 52	— 5A	7 62	E 6A	D 72	C 7A
	3	Spanish		J4	k1 1B	1 23	INS CHR 2B	STEP 33	EXEC 3B	— 43	/ 4B	\$ 53	— 5B	SPACE 63	R 6B	F 73	V 7B
	4	Kana		J5	k2 1C	k8 24	DEL CHR 2C	CLR LN 34	0 3C	4 44	E 4C	% 54	 5C	O 64	T 6C	G 74	B 7C
	5	J9		J6	k5 1D	k9 25	CLR END 2D	RESULT 35	3D	5 45	( 4D	^ 6 55	1 5D	P 65	Y 6D	H 75	N 7D
	6	J10		J7	k6 1E	— 26	BACK SPACE 2E	PRT ALL 3E	3E	6 46	) 4E	& 56	: 5E	K 66	U 6E	J 76	
	7	J11		J8	k7 1F	— 27	RUN 2F	CLR I/O 3F	+ 3F	* 47	< 4F	* 8 57	11 5F	L 67	1 6F	M 77	

**Key** Key is the key name that appears on a standard keyboard.  
**Code** Code is the hex code sent to the 68000.

## Rectifier Board Terminal Wiring

Terminal	Wire Function	Color	Color Code
1	Transformer Sec.	Brown	1
2	Capacitor, neg.	Brown	1
3	Reg. Bd., ground	Brown	1
4	Batt. Neg. (Powerfail Opt.)	Brown	1
5	Power Switch	Grey	8
6	Transformer Pri.	Orange	3
7	Transformer Pri.	Orange/black	3/0
8	Transformer Pri.	Black/green	0/5
9	Fan	Black	0
10	Transformer Pri.	Black/yellow	0/4
11	Transformer Pri.	Black	0
12	Power Switch	White/red/grey	9/2/8
13	Transformer Pri.	Black/red	0/2
14	Fan	Black	0
15	Capacitor, pos.	Yellow	4
16	15 A Fuse	Yellow	4
17	Batt. Pos. (Powerfail Opt.)	Yellow	4
18	Regulator Board	White/yellow/grey	9/4/8
19	Transformer Sec.	Red	2
20	Transformer Sec.	Red	2

## Rectifier Board Terminals

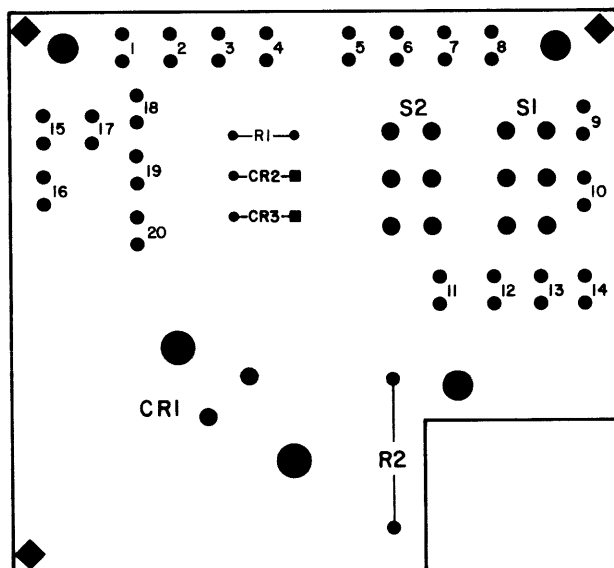

# 9826 Motherboard Connector Pin Assignments

J6 CRT DIGITAL BOARD

GND	1	2	18MHz
GND	3	4	GND
DMAR1	5	6	DMACK1
GND	7	8	GND
VPA	9	10	E
VMA	11	12	INT4
+5V	13	14	+5V
CSCRT	15	16	CSGRAP
GND	17	18	GND
DMARDY	19	20	DMONE
NC	21	22	NC
NC	23	24	ENOT
FC2	25	26	FC1
FC2	27	28	DTACK
GND	29	30	GND
RESET	31	32	BERR
GND	33	34	GND
ICW	35	36	IOR
BLOS	37	38	BUDS
BRW	39	40	BAS
GND	41	42	GND
HALT	43	44	BA1
BA2	45	46	BA3
BA4	47	48	BAS
BA6	49	50	BA7
BA8	51	52	BA9
BA10	53	54	BA11
GND	55	56	GND
BA12	57	58	BA13
BA14	59	60	BA15
BA16	61	62	BA17
BA18	63	64	BA19
BA20	65	66	BA21
BA22	67	68	BA23
+5V	69	70	+5V
BD0	71	72	BD1
BD2	73	74	BD3
BD4	75	76	BDS
BD6	77	78	BD7
GND	79	80	GND
BD8	81	82	BD9
BD10	83	84	BD11
BD12	85	86	BD13
BD14	87	88	BD15
+5V	89	90	+5V
FULL	91	92	HALF
GND	93	94	GND
HRTC	95	96	NC
VERT2	97	98	VERT1
-12V	99	100	+12V

J5 DISC DRIVE CONTROLLER BOARD

GND	1	2	18MHz
GND	3	4	GND
DMAR1	5	6	DMAR1
DMACK	7	8	DMACK1
GND	9	10	GND
INT2	11	12	CSDRSC
+5V	13	14	+5V
DMARDY	15	16	INT3
INT2	17	18	INT5
GND	19	20	GND
BG1	21	22	BG3
BS2	23	24	BR
DMARDY	25	26	BGACK
NC	27	28	NC
NC	29	30	ENOT
FC8	31	32	FC1
FC2	33	34	DTACK
GND	35	36	GND
RESET	37	38	BERR
GND	39	40	GND
ICW	41	42	IOR
BLOS	43	44	BUDS
BRW	45	46	BAS
GND	47	48	GND
HALT	49	50	BA1
BA2	51	52	BA3
BA4	53	54	BAS
BA6	55	56	BA7
BA8	57	58	BA9
BA10	59	60	BA11
GND	61	62	GND
BA12	63	64	BA13
BA14	65	66	BA15
BA16	67	68	BA17
BA18	69	70	BA19
BA20	71	72	BA21
BA22	73	74	BA23
GND	75	76	GND
BD0	77	78	BD1
BD2	79	80	BD3
BD4	81	82	BDS
BD6	83	84	BD7
+5V	85	86	+5V
BD8	87	88	BD9
BD10	89	90	BD11
BD12	91	92	BD13
BD14	93	94	BD15
GND	95	96	GND
NC	97	98	NC
-12V	99	100	+12V

J4 EXPANSION SLOT

DMAR1	1	2	DMAR1
DMACK8	3	4	DMACK1
NC	5	6	INT7
INT2	7	8	INT1
DMARDY	9	10	BG1
BS2	11	12	BG2
GND	13	14	GND
INT4	15	16	INT3
INT4	17	18	INT5
VECTOR	19	20	IACK
GND	21	22	GND
BG	23	24	BR
DMARDY	25	26	BGACK
NC	27	28	NC
NC	29	30	ENOT
FC8	31	32	FC1
FC2	33	34	DTACK
NC	35	36	GND
RESET	37	38	BERR
GND	39	40	GND
ICW	41	42	IOR
BLOS	43	44	BUDS
BRW	45	46	BAS
GND	47	48	GND
HALT	49	50	BA1
BA2	51	52	BA3
BA4	53	54	BAS
BA6	55	56	BA7
BA8	57	58	BA9
BA10	59	60	BA11
GND	61	62	GND
BA12	63	64	BA13
BA14	65	66	BA15
BA16	67	68	BA17
BA18	69	70	BA19
BA20	71	72	BA21
BA22	73	74	BA23
GND	75	76	GND
BD0	77	78	BD1
BD2	79	80	BD3
BD4	81	82	BDS
BD6	83	84	BD7
+5V	85	86	+5V
BD8	87	88	BD9
BD10	89	90	BD11
BD12	91	92	BD13
BD14	93	94	BD15
DGN03	95	96	DGN03
NC	97	98	NC
-12V	99	100	+12V

J3 PROCESSOR BOARD

+5V	1	2	+5V
IO	3	4	IO
INT2	5	6	INT1
GND	7	8	GND
VMA	9	10	VMA
INT4	11	12	E
GND	13	14	GND
INT4	15	16	INT3
INT4	17	18	INT5
VECTOR	19	20	IACK
GND	21	22	GND
BG	23	24	BR
GND	25	26	BGACK
BERR	27	28	NC
NC	29	30	ENOT
FC8	31	32	FC1
FC2	33	34	DTACK
NC	35	36	GND
RESET	37	38	PURESET
GND	39	40	GND
ICW	41	42	IOR
BLOS	43	44	BUDS
BRW	45	46	BAS
GND	47	48	GND
HALT	49	50	BA1
BA2	51	52	BA3
BA4	53	54	BAS
BA6	55	56	BA7
BA8	57	58	BA9
BA10	59	60	BA11
GND	61	62	GND
BA12	63	64	BA13
BA14	65	66	BA15
BA16	67	68	BA17
BA18	69	70	BA19
BA20	71	72	BA21
BA22	73	74	BA23
GND	75	76	GND
BD0	77	78	BD1
BD2	79	80	BD3
BD4	81	82	BDS
BD6	83	84	BD7
GND	85	86	GND
BD8	87	88	BD9
BD10	89	90	BD11
BD12	91	92	BD13
BD14	93	94	BD15
+5V	95	96	+5V
NC	97	98	NC
-12V	99	100	+12V

J2 ACCESSORY CARD CAGE

DMAR1	1	2	DMAR1
DMACK1	3	4	DMACK1
NC	5	6	INT7
INT2	7	8	INT1
DMARDY	9	10	BG1
BS2	11	12	BG2
GND	13	14	GND
INT4	15	16	INT3
INT4	17	18	INT5
VECTOR	19	20	IACK
GND	21	22	GND
BG	23	24	BR
DONE	25	26	BGACK
NC	27	28	NC
NC	29	30	ENOT
FC8	31	32	FC1
FC2	33	34	DTACK
NC	35	36	GND
RESET	37	38	BERR
GND	39	40	GND
ICW	41	42	IOR
BLOS	43	44	BUDS
BRW	45	46	BAS
GND	47	48	GND
HALT	49	50	BA1
BA2	51	52	BA3
BA4	53	54	BAS
BA6	55	56	BA7
BA8	57	58	BA9
BA10	59	60	BA11
GND	61	62	GND
BA12	63	64	BA13
BA14	65	66	BA15
BA16	67	68	BA17
BA18	69	70	BA19
BA20	71	72	BA21
BA22	73	74	BA23
GND	75	76	GND
BD0	77	78	BD1
BD2	79	80	BD3
BD4	81	82	BDS
BD6	83	84	BD7
+5V	85	86	+5V
BD8	87	88	BD9
BD10	89	90	BD11
BD12	91	92	BD13
BD14	93	94	BD15
DGN03	95	96	DGN03
NC	97	98	NC
-12V	99	100	+12V

J11 KEYBOARD CONNECTOR

GND	1	2	RP08
+5V	3	4	RP04
GND	5	6	S1
SP	7	8	S8
GND	9	10	SP
SP	11	12	RP8
R1	13	14	RP2
R3	15	16	RP4
R5	17	18	RP6
R7	19	20	C15
C14	21	22	C13
C12	23	24	C11
C10	25	26	C9
C8	27	28	C7
C6	29	30	C5
C4	31	32	C3
C2	33	34	C8

J10 POWERFAIL CONNECTOR

+5V	1	2	+5V
GND	3	4	INT7
GND	5	6	PURESET
GND	7	8	SHUTDOWN
GND	9	10	BRW
IOR	11	12	BA5
PF15	13	14	BA6
PF16	15	16	BD0
GND	17	18	BD1
GND	19	20	BD2
GND	21	22	BD3
GND	23	24	BD4
GND	25	26	BD5
GND	27	28	BD6
GND	29	30	BD7
GND	31	32	CSBAT
GND	33	34	INT1

J9 DISC DRIVE POWER

1	L1 +5V
2	GND
3	DGN01
4	+12V01

J8 REGULATOR BOARD

PURESET	1	2	SHUTDOWN
DGN02	3	4	DGN02
NC	5	6	NC
DGN01	7	8	PF16
GND	9	10	GND
+12V01	11	12	-12V
+5V	13	14	+5V
+12V	15	16	+12V
GND	17	18	GND
+12V02	19	20	+5V
-12V	21	22	-12V
GND	23	24	GND
+5V	25	26	+5V
+5V	27	28	+5V
GND	29	30	GND
DGN03	31	32	DGN03

J7 CRT ANALOG BOARD

1	-12V02
2	DGN02 (CRT)
3	GND (SYS)
4	HRTC
5	GND (SYS)
6	HALF
7	FULL
8	GND (SYS)
9	VERT1
10	VERT2
11	GND
12	+5V
13	-12V
14	-12V



# 9836 Motherboard Connector Pin Assignments

J6 DISC DRIVE



J5 DISC DRIVE CONTROLLER BOARD

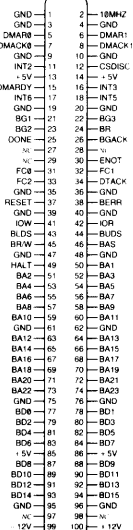

J4 EXPANSION SLOT

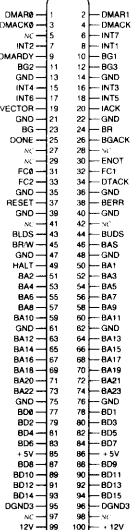

J3 PROCESSOR BOARD

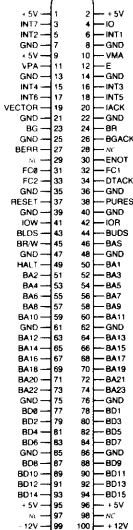

J2 ACCESSORY BACKPLANE

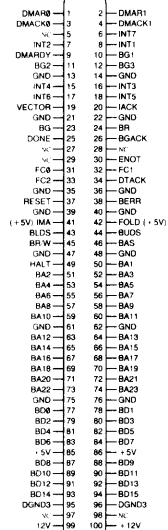

J11 KEYBOARD CONNECTOR

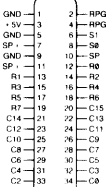

J10 POWER/ALL CONNECTOR

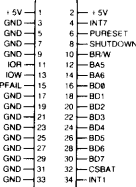

J9 DISC DRIVE POWER



J8 REGULATOR BOARD

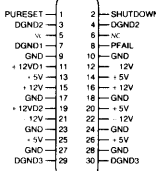

J7 CRT ANALOG BOARD

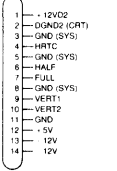

J16 CRT ANALOG CONNECTOR

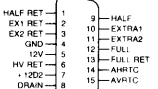

J14 VIDEO CONNECTOR (QUAD COAX)

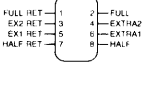

J13 CRT J2 CONNECTOR

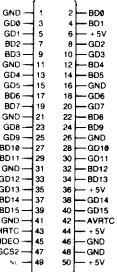

J12 CRT J1 CONNECTOR

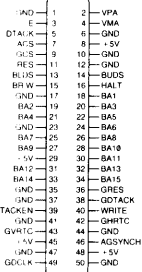

## Motherboard Signal Lines and Mnemonics

BA1-23	Buffered address lines 1-23
BAS	Buffered address strobe
BD0-15	Buffered data lines 0-15
BERR	Bus error
BG	Bus grant
BG1-3	Bus grant 1-3
BGACK	Bus grant acknowledge
BLDS	Buffered lower data strobe
BR	Bus request
BR/W	Buffered read/write
BUDS	Buffered upper data strobe
C0-15	Keyboard columns 0-15
CSCRT	CRT controller chip and RAM select
CSDISC	Disc drive controller chip select
CSGRAPH	Graphics RAM chip select
DGND1-3	Dirty ground 1-3
DMACK0-1	Direct memory access acknowledge 0-1
DMAR0-1	Direct memory access request 0-1
DMARDY	Direct memory access ready (to/from I/O card)
DONE	Direct memory access transfer done
DTACK	Data transfer acknowledge
E	E (6800 cycle)
ENDT	Enable DTACK (for 5 state access)
FC0-2	Function code 0-2 (from 68000)
FOLD	Fold lower byte to upper byte (DMA)
FULL	Full-bright video
GND	Ground
HALF	Half-bright video
HALT	Halt
HRTC	Horizontal retrace
IACK	Interrupt acknowledge
IMA	I'm addressed (accessory backplane only)
INT1-7	Interrupt 1-7
IO	I/O address space accessed
IOR	Input/output read
IOW	Input/output write
PFAIL	Input power failed
PURESET	Power-up reset
R1-7	Keyboard rows 1-7
RESET	Reset
RPGA-B	Rotary control knob lines
S0	Shift key
S1	Control key
SHUTDOWN	Shutdown
SP	Speaker
VECTOR	Vectored interrupt active
VERT1-2	CRT vertical deflection current
VPA	Valid peripheral address (6800 cycle)
VMA	Valid memory address (6800 cycle)

## Power Supply Specifications

**Table 5-1A. "51" Board Specifications**

Voltage	Voltage Tolerance	Maximum Current	Ripple	Used By
-12 V	-11.76 to -12.24 V	1.32 A	75 mV	Digital board Disc drive control I/O cards (RS-232)
+5 V	4.95 to 5.05 V	13.5 A	45 mV	All assemblies
+12 V	11.7 to 12.3 V	3.15 A	75 mV	Analog board Digital board Disc drive control Disc drive mechanism I/O cards (RS-232)

**Table 5-1B. "53" Board Specifications**

Voltage	Voltage Tolerance	Maximum Current	Ripple	Used By
-12 V	-11.82 to -12.18 V	1.32 A	75 mV	Digital board Disc drive control I/O cards (RS-232)
+5 V	5.05 to 5.11 V	18.9 A	50 mV	All assemblies
+12 V	11.84 to 12.16 V	3.74 A	85 mV	Analog board Digital board Disc drive control Disc drive mechanism I/O cards (RS-232)

# Chapter 10

## 9826/9836 Reference

### Typical Backplane Power Available

#### Power Supply

Voltage	9826	9836A/C
+ 5 Vdc	38W	38W
+ 12 Vdc	11W	11W
- 12 Vdc	7W	7W
Backplane Max.	42W	42W

### Accessories Typical Power Requirements

Product Number	Accessory Description	Typical Max Watts Each P/S Voltage			Typical Max Watts Per Acc
		+ 5	+ 12	- 12	
9888A	Bus Expander	5.0			5.0
13264A	Data Link Pod	0.2	1.9	0.3	2.4
13265A	Modem	0.5	0.5	0.5	1.5
13266A	Current Loop Pod	1.0	1.0	1.0	3.0
98028A	Resource Mgmt. Multiplex	2.2	6.4		8.6
98201A	Custom Keypad Card	0.1			0.1
98204A	Comp. Vid. w/o Graph	5.2	0.1		5.3
98204A	Comp. Vid. with Graph	6.5	0.1		6.6
98253A	EPROM Prgm. Assy.	5.7			5.7
98254A	64K-byte RAM	3.0			3.0
98255A	EPROM Card	2.8			2.8
98256A	256k byte RAM	4.1			4.1
98259A	128k byte Bubble Memory	2.4	2.9		5.3
98601A	BASIC 2.0 ROM	2.4			2.4
98602A	BASIC 2.1 ROM	3.6			3.6
98604A	HPL 2.0 ROM	1.5			1.5
98620A	DMA Controller	6.0			6.0
98621A	OPT 001 BASIC 1.0 ROM	2.3			2.3
98621A	OPT 004 HPL 1.0 ROM	2.0			2.0
98622A	GPIO Interface	3.8			3.8
98623A	BCD Interface	2.5			2.5
98624A	HP-IB Interface	2.4			2.4
98625A	Disc Interface	3.0	0.1		3.1
98626A	RS-232 Interface	2.0	0.6	0.6	3.2
98627A	Color Video Interface	5.5			5.5
98628A	Data Communications	3.6	0.5	0.7	4.8
98629A	Resource Mgt. w/o 98028A	3.7	0.5	0.5	4.7
98629A	Resource Mgmt. w/98028A*	5.9	6.8	0.5	13.2
98630A	Breadboard Card (Unloaded)	1.3			1.3
98691A	Programmable Datacomm	3.6	0.5	0.7	4.8
98206-66501	Series 200 Test Card	4.2			4.2
98206-66533	Keyboard/HP-IB Intfc.	2.6			2.6
09920-66534	Kbd./HP-IB lfc. w/beep	2.6			2.6

\* A 9826 9836 SRM system configured with two 98629A-98028A cards and one 98625A card will exceed the + 12 Vdc power limit. The unique characteristics of the SRM system permit this exception. When this configuration is used in a 9826 9836, no other cards using power from the computer's - 12 Vdc power supply may be used.



# Chapter 11

## 9826/9836 Service Notes

Service Notes will be published in **Support Update**. They are printed in reduced size for placing in this binder. Remove them from the **Support Update**, and place them behind this page.

## Service Notes (continued)