

DIAGNOSTIC CONFIGURATOR

reference manual

For HP 2114, 2115, 2116, 2100, and HP 1000 M-, E-, and F-Series Computer Systems using the HP 24396A through HP 24396F Diagnostics on Multimedia or the HP 24998-14002 Diagnostic Library for the HP 1000 Computer Systems.

ABSOLUTE BINARY PROGRAM NO. 24296-60001
DATE CODE 1928

PRINTING HISTORY

The Printing History below identifies the Edition of this Manual and any Updates that are included. Periodically, Update packages are distributed which contain replacement pages to be merged into the manual, including an updated copy of this Printing History page. Also, the update may contain write-in instructions.

Each reprinting of this manual will incorporate all past Updates, however, no new information will be added. Thus, the reprinted copy will be identical in content to prior printings of the same edition with its user-inserted update information. New editions of this manual will contain new information, as well as all Updates.

To determine what manual edition and update is compatible with your current software revision code, refer to the appropriate Software Numbering Catalog, Software Product Catalog, or Diagnostic Configurator Manual.

First Edition	Mar 1979	Date Code 1627.
Update 1	Jun 1979	Revised to incorporate Date Code Revisions to 1926.
Update 2	Jan 1980	Revised to incorporate Date Code Revisions to 1928.
Update 3	Mar 1980	Update 2 incorrectly specified on U1, U2, and ii as 2001 update. Changed to 1928.
Update 4	Jun 1980	Revised to incorporate Date Code Revisions to 2026.
Update 5	Oct 1980	The 9-track Mag Tape Diagnostic has been updated to Date Code Revision 2040.
Reprint	Oct 1980	Revised to incorporate Update 5.

NOTICE

The information contained in this document is subject to change without notice.

HEWLETT-PACKARD MAKES NO WARRANTY OF ANY KIND WITH REGARD TO THIS MATERIAL, INCLUDING, BUT NOT LIMITED TO, THE IMPLIED WARRANTIES OF MERCHANTABILITY AND FITNESS FOR A PARTICULAR PURPOSE. Hewlett-Packard shall not be liable for errors contained herein or for incidental or consequential damages in connection with the furnishing, performance or use of this material.

Hewlett-Packard assumes no responsibility for the use or reliability of its software on equipment that is not furnished by Hewlett-Packard.

This document contains proprietary information which is protected by copyright. All rights are reserved. No part of this document may be photocopied, reproduced or translated to another program language without the prior written consent of Hewlett-Packard Company.

LIST OF EFFECTIVE PAGES

The List of Effective Pages gives the most recent update number on which the technical material on any given page was altered. If a page is simply re-arranged due to a technical change on a previous page, it is not listed as a updated page. Within the manual, changes are marked with a vertical bar in the margin. When a update is incorporated in a reprinted manual, the update number and vertical bar in the margin is removed but the update number will remain on this List of Effective Pages page.

Pages	Update No.	Pages	Update No.
Title	3		
ii and iii	3		
1-4	1		
2-8	1		
2-11	1		
A-3/A-4	2		
A-5/A-6	2		

CONTENTS

Section I	Page	Configuration of Drivers	3-6
INTRODUCTION		Table of Drivers	3-7
General	1-1	Utility Routines	3-7
Required Hardware	1-2	Timer or Wait Loop (One Millisecond)	3-8
Required Software	1-3	S-Register Check	3-8
Text Conventions Used	1-3	Decimal to ASCII Conversion	3-8
Configurator Limitations	1-4	Octal to ASCII Conversion	3-9
		ASCII to Binary Conversion	3-9
		Formatted Output	3-9
Section II	Page	Configured Drivers	3-11
OPERATING PROCEDURE		Console Output	3-11
Operational Overview	2-1	Console Input	3-11
Configurator Loading Procedure	2-3	Line Printer Output	3-12
Register Usage	2-3		
S-Register	2-3	Appendix A	Page
A- and B-Registers	2-5	DIAGNOSTIC SERIAL NUMBERS	A-1
Configurator Pretest	2-6		
Conversational Configuration	2-7	Appendix B	Page
Automatic Configuration	2-7	CONFIGURATOR HALT CODE SUMMARY	B-1
Manual Configuration	2-12		
Configurator Binary Loader	2-15	Appendix C	Page
Dump to Paper Tape	2-16	OPERATOR'S NOTES	C-1
Section III	Page	Appendix D	Page
PROGRAM DESCRIPTION		PRETEST SOURCE LISTING	D-1
General Organization	3-1		
Configurator Linkage Area	3-1	Appendix E	Page
Pretest	3-2	BASIC BINARY LOADER LISTINGS	E-1
Computer Parameters	3-5		

ILLUSTRATIONS

Figure	Page	Figure	Page
Operational Overview Flowchart	2-2	Linkage Area	3-3
Configurator Loading Procedure Flowchart	2-4	Diagnostic Serial Number (DSN)	3-4
Configurator Pretest Flowchart	2-8	Computer Type and Options	3-5
Conversational Configuration Flowchart	2-9	Memory Size	3-6
Automatic Configuration Flowchart	2-11	Program Transfer Guide	C-1
Manual Configuration Flowchart	2-13	Magnetic Tape and Cartridge Tape Format	C-2
Configurator Binary Loader Flowchart	2-17	Disc Initialization Flowchart	C-4
Paper Tape Dump Routine Flowchart	2-19	Dual Computer Link	C-7
Memory Map	3-2	Cross Link Flowchart	C-9

Table	Page
Summary of A- and B-Register Concept	2-5
Diagnostic Reference Table for HP 24396A-F Products	A-3
Diagnostic Reference Table for Part No. 24998-14002	A-5
Basic Binary Loader Reference	E-1
HP 7900/7901 Disc Boot Loader	E-3
HP 7905/20 Disc Boot Loader	E-4
HP 2644/45 Cartridge Tape Binary Loader	E-5
HP 7970B/7970E Magnetic Tape Binary Loader ...	E-7

INTRODUCTION

SECTION

I

1-1. GENERAL

This manual describes the operation and use of the Diagnostic Configurator (hereafter called the Configurator), a standalone program loaded into an HP 1000 M-Series, E-Series, F-Series, 2100A/S, 2116A/B/C, 2115A, or 2114A/B Computer System* before other diagnostics. The program loads and controls the sequential execution of most of the HP 2100 Series Computer, interface, and peripheral equipment diagnostics, and they in turn reference the Configurator for certain parameters required by the diagnostics.

The Configurator is available on all diagnostic media which include paper tape, HP 7900/7905/7906 Disc, HP 7970B/E Magnetic Tape, and HP 2644/2645/48 Cartridge Tape.

The six media which carry the diagnostic library are employed to give the user a choice of several input devices. Any one of the diagnostic media listed below carries a special product number which includes the diagnostic library on the specified medium and all associated manuals:

PRODUCT NO.	MEDIUM	COMMENT
24396A	Paper Tape	} All Configurator-compatible diagnostics on any medium.
24396B	7900 Disc	
24396C	7905 Disc	
24396D	7970B Magnetic Tape	
24396E	7970E Magnetic Tape	
24396F	2644/45 Cartridge Tape	
		} All Configurator-compatible diagnostics on 7 cartridge tapes.

In addition to the 6 products mentioned above which provide all configurator compatible diagnostics on different media a special selection of diagnostics has been created. This selection (part no. 24998-14002) carries only the diagnostics which are compatible with the HP 1000 System. It consists of 6 HP 2645 cartridge tapes, and the appropriate manuals and is supplied with an HP 1000 System.

Two Diagnostic Reference Tables, which are provided in appendix A, list the Diagnostic Serial Numbers (DSN), diagnostic designations, and the associated part numbers for the HP 2100 Series diagnostics and the appropriate manuals used with the Configurator.

Table A-1 lists all the diagnostics available on the 6 media, table A-2 lists the selected diagnostics for the HP 1000 System.

The Configurator furnishes drivers (console, line printer, and diagnostic input) and commonly used utility routines for the diagnostic program. It also sets parameters related to the computer which can be referenced by the executing diagnostic. This allows a diagnostic, in conjunction with the Configurator, to test an HP 2100 Series Computer, an interface board, or a peripheral subsystem connected to the computer.

*Throughout the rest of this manual, the term "2100 Series Computer" will be used as a general reference to any one of the above-mentioned computer systems. When specifically required, the term "21MX" will be used to specify a 21MX M-Series, E-Series, or 21MX F-Series Computer.

The Configurator can be executed in three basic modes: Conversational, Automatic, and Manual. Other features in the Configurator include a Pretest (for the CPU, memory, and basic I/O), Binary Loaders, Paper Tape Dump routine, and the ability to sequentially execute diagnostics (Long Diagnostic). The Pretest is used when the CPU is in question and a check is desired prior to configurations. The Binary Loaders allow the operator to load diagnostics from any standard input device. (See paragraph 1-2d.) The Paper Tape Dump routine is used to dump (to paper tape) an absolute binary copy of the object code currently in memory. Sequential diagnostic execution capabilities are included to allow the operator to execute diagnostics in the Long Diagnostic mode from any one of the specified input devices.

It should be noted that previous diagnostics were coded for a particular computer system such as the diagnostics designed exclusively for the HP 2116 Computers. The Diagnostic Configurator is not compatible with these single computer diagnostics. However, it is possible to use the Teleprinter Driver portion of the Configurator in conjunction with previous diagnostics. Since, during the loading process, such a previous diagnostic will overlay portions of the Configurator, it is necessary to reload the Configurator when it is desired to run a newer type of diagnostic listed in appendix A. Any programs loaded with the Configurator shall not overlay the linkage area except locations 100, 105, 116, and 126 (octal). (See figure 3-2.)

Also included in this manual are the descriptions and procedures for storing the Configurator, diagnostics, and control programs on disc (Disc Initialization) and interconnecting two CPU's (Cross Link). The binary object programs are separated from the Configurator and have their own DSN's. They must be loaded prior to execution. Disc initialization is covered in appendix C, paragraph C-3 and cross link in appendix C, paragraph C-10.

1-2. REQUIRED HARDWARE

The following hardware is required:

- a. An HP 2100 Series Computer with at least 4K of memory. When a computer has more than 4K of memory, the Configurator utility routines and device drivers are relocated to the last page of memory. See paragraphs 1-5 and 2-10c for memory size restrictions. The computer must have the configured basic binary loader (BBL), for the medium on which the Configurator is stored, in the last 64 (decimal) locations in memory. (Refer to appendix E.)
- b. A loading device for the medium on which the Configurator is stored. (Normally this is the same as the diagnostic input device.)
- c. A console device, for operator communication, is optional. If a console is used, the interface must be an HP 12531B/C/D, HP 12880A, HP 12587B, HP 12966A or HP 12968A.
- d. A diagnostic input device. (The device for loading depends upon the medium on which the Configurator/diagnostic(s) are distributed or available.)
 - (1) Paper tape reader: HP 2737A/B, HP 2748A/B, HP 2758A (or teleprinter with paper tape reader).
 - (2) Magnetic tape unit: HP 7970B/E (9-track only, unit 0 only); requires DMA (DCPC).
 - (3) Cartridge disc: HP 7900A or HP 7901A (unit 0, removable platter only); requires DMA (DCPC).

- (4) Cartridge disc: HP 7905A (unit 0, removable platter and upper surface only) or 7920A (unit 0, upper surface only); requires DMA (DCPC). The disc can only be interconnected to those computers specified in the appropriate hardware manuals.
- (5) Cartridge tape: HP 2644A or 2645A Terminal; requires HP 12966A interface (strapped for external baud rate). (Operator must preselect left/right CTU. Refer to Owner's Manual, part no. 02644-90001 or 02645-90001.)
- e. A line printer (optional, only if the diagnostic requires one): HP 2767A, HP 2610A, HP 2614A, HP 2613A, HP 2617, HP 2618A, HP 2607A, HP 2778A, HP 9866A.
- f. A punch device (required for paper tape dump routine only): HP 2753A or HP 2895A.

Note: Throughout the rest of this manual, model numbers may be abbreviated for simplicity (e.g., HP 2737A/B will be simply 2737).

1-3. REQUIRED SOFTWARE

Additional software beyond the diagnostic(s) or control program(s) to be executed is not required by the Configurator. However, the operator should make sure that the diagnostic(s)/control program(s) to be run have been designed to be used with the Configurator. These programs are listed in appendix A.

1-4. TEXT CONVENTIONS USED

All halt codes, select codes, and addresses used in this manual are in octal unless specifically shown otherwise. Whenever the term "Press PRESET" is used in this manual it applies, in case of an HP 2100A/S, that "INTERNAL PRESET" as well as "EXTERNAL PRESET" has to be pressed. Throughout the flowcharts, notes, and text that follow, abbreviations may be used where necessary to conserve space and reduce confusion. The abbreviations used are listed below. (Such abbreviations as BBL, IBL, I/O, etc., are commonplace in HP 2100 Series Computer manuals and are not listed here.)

ABBREVIATION	MEANING
ADDR	Address
A-REG	A-Register
BMDL	Binary Moving Head Disc Loader
B-REG	B-Register
CART. DISC	Cartridge Disc
CR	Carriage Return
CTU	Cartridge Tape Unit
DC	Date Code
DCPC	Dual Channel Port Controller
DIAG	Diagnostic
DMA	Direct Memory Access
DRT	Diagnostic Reference Table
DSN	Diagnostic Serial Number

ENBL	Enable
EOF	End-of-File
EOM	End-of-Message
E-REG	E-Register
FWA	First Word of Available Memory
HLT(S)	Halt or halts
LF	Line Feed
LWA	Last Word of Available Memory
MAG TAPE	Magnetic Tape
MPRT	Memory Protect
M-REG	M-Register
P-REG	P-Register
REV.	Revision
RTE	Real-Time Executive
SC	Select Code
S-REG	Switch Register (or Display Register)
T-REG	T-Register (or Memory Data Register)
WCS	Writable Control Store

1-5. CONFIGURATOR LIMITATIONS

If a diagnostic, which relocates the Configurator to a different area in memory, is executed and then aborted, the restart procedures as outlined in paragraph 2-10 and figure 2-7 cannot be employed. The Configurator has to be reloaded with the binary loader and configured to continue with the execution of other diagnostics.

It is not advisable to utilize a diagnostic input device which has write capabilities (disc, magnetic tape, cartridge tape) if the functional integrity of the hardware is in question.

Due to the fact that the A-, B- and P-Register on the HP 2114A/B computer can only be accessed via the Switch Register, it is mandatory that the A-, B-, P- and S-Registers be addressed in this sequence whenever the Configurator procedure calls for updating or modifying a register. Whenever the A- and/or B-Register are modified, the P- and S-Register contents have to be restored.

On an HP 2115A/B or HP 2116A/B/C Computer, the A-, B- and P-Registers can be modified in any sequence; however, the S-Register must be the last one set.

The FPP/SIS/FFP Diagnostic (DSN 101121) cannot be executed in the automatic sequential load manner. The DSN must be specified in the A-register, and the diagnostic selection in the B-register with bit 15 of the S-register set.

The minimum memory size required is 4K. If the diagnostic to be executed or dumped on paper tape requires more than 4K, the minimum memory size is determined by the diagnostic and listed in the appropriate Diagnostic Reference Manual and in appendix A of this manual. Table A-1 lists software and manual part numbers of all diagnostics that run under control of the Configurator. If a diagnostic occupies any memory locations in the area N6300 through N6500 and the diagnostic is loaded from a disc, the available memory size is insufficient. (N= 0 for 4K, N= 1 for 8K, N= 2 for 12K, and N= 3 for 16K. If more than 16K are available, this limitation cannot be reached with any diagnostics). See also paragraph 2-10c.

If the Writable Control Store (WCS) accessory is installed, it must be disconnected to run the pretest because it issues an STF instruction to all SC's. The same applies for all I/O related diagnostics which employ a basic I/O test.

If the 12979B Dual-Port I/O Extender is installed and pretest or any I/O related diagnostic is to be run, the extender should be "locked" to the port (either A or B) that the computer running the diagnostic is connected to.

Full system dedications is required during loading and configuring the Configurator. This also applies to all associated components of the diagnostic input device.

2-1. OPERATIONAL OVERVIEW

This section describes the procedures for loading the Configurator, executing the Pretest, configuring the Configurator, and loading the diagnostics. The operating procedures are shown in flowcharts with notes where necessary for clarification.

There are three procedures for configuring the program: Conversational, Automatic, and Manual. The Conversational method provides a means of configuring the program from the console with one input from the S-Register and utilizing the parameters calculated by the program. This method is recommended for the user who is not familiar with the Configurator. The Automatic method provides a means of configuring the program with one input from the S-Register (A- and B-Registers) and utilizing the parameters calculated by the program. The Manual method provides a means of configuring the program using the S-Register exclusively and allows modification of the parameters calculated by the program.

The Conversational or Manual methods of configuration must be used when a line printer is required by a diagnostic.

Prior to configuration, the operator may execute the Pretest to ensure that the basic instructions of the CPU can be executed and the drivers will be configured correctly.

A general loading procedure flowchart for the various devices and computers is furnished as a quick reference in figure 2-1.

The basic configuration procedure is:

1. LOAD THE CONFIGURATOR PROGRAM (figure 2-2).

Note: Immediately after loading the Configurator (a diagnostic or a control program), the Diagnostic Serial Number (DSN) which resides in memory location 126 (octal) may be checked for a match with the information shown in the left-hand column of table A-1 in appendix A of this manual.

2. SET P-REG TO:
 - (a) 2 → to execute the Pretest prior to configuration (figure 2-3).
 - (b) 100 → to start configuration directly.

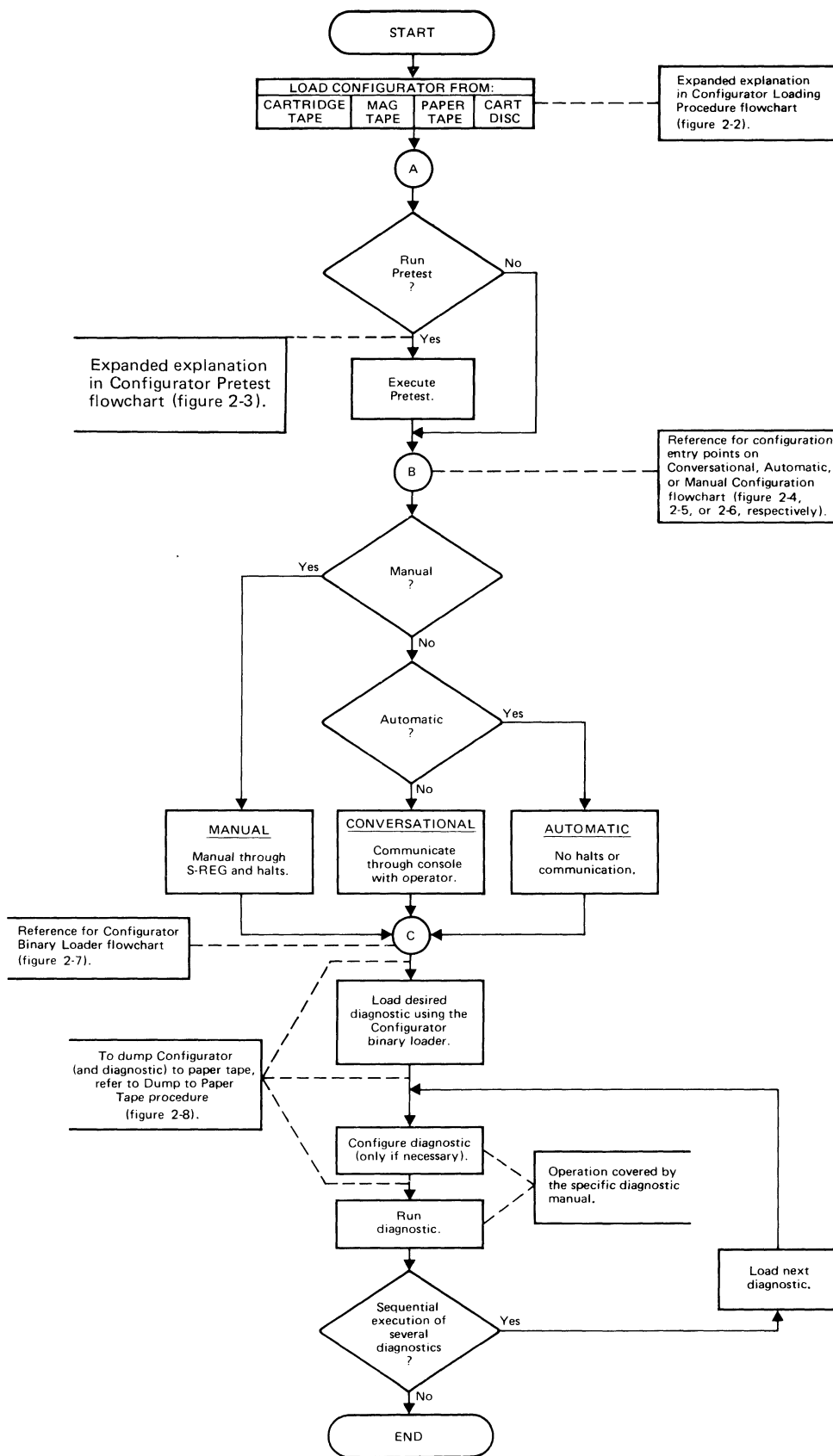

7 132-1

Figure 2-1. Operational Overview Flowchart

3. SET S-REG TO: (a) The console select code (Conversational, figure 2-4).

-or-

- (b) The console select code, diagnostic input device select code, and diagnostic input device type. Set bit 15 if the A-Register specifies a DSN and the B-Register the diagnostic to be loaded and executed following the specified DSN (Automatic, figure 2-5).

-or-

- (c) Clear (Manual, figure 2-6).

4. PRESS PRESET, RUN.

Note: Running time for the Configurator is entirely dependent upon the selection or deletion of the Pretest, the mode selected, and operator response time. (The Pretest requires approximately 10 seconds for a CPU with 32K of base memory.)

2-2. CONFIGURATOR LOADING PROCEDURE

Figure 2-2 is the flowchart for loading the Configurator. Paragraph 2-10 provides information for loading diagnostics after the Configurator is loaded and configured.

2-3. REGISTER USAGE

The following describes the use of the four registers (P, S, A and B) during configuration and the loading of diagnostics. The P-Register, as shown in the table below, shows the starting address of the various programs and the required registers.

P-REGISTER	PROGRAM SELECTION	REQUIRED REGISTERS
2	Execute Pretest	S-A-B
100	Configure Diagnostic Configurator	S-A-B
120	Load Diagnostics	A-B
N7677	Dump to Paper Tape	S

2-4. S-REGISTER

As shown in the table below, the S-Register is used to indicate which configuration mode (Automatic, Conversational, or Manual) shall be used. If only the console is specified, then Conversational is used. If the console and the input device are specified, then Automatic is used. If the S-Register is left clear, then Manual is used. If a legal but incorrect SC is given for an I/O device, the result is unpredictable.

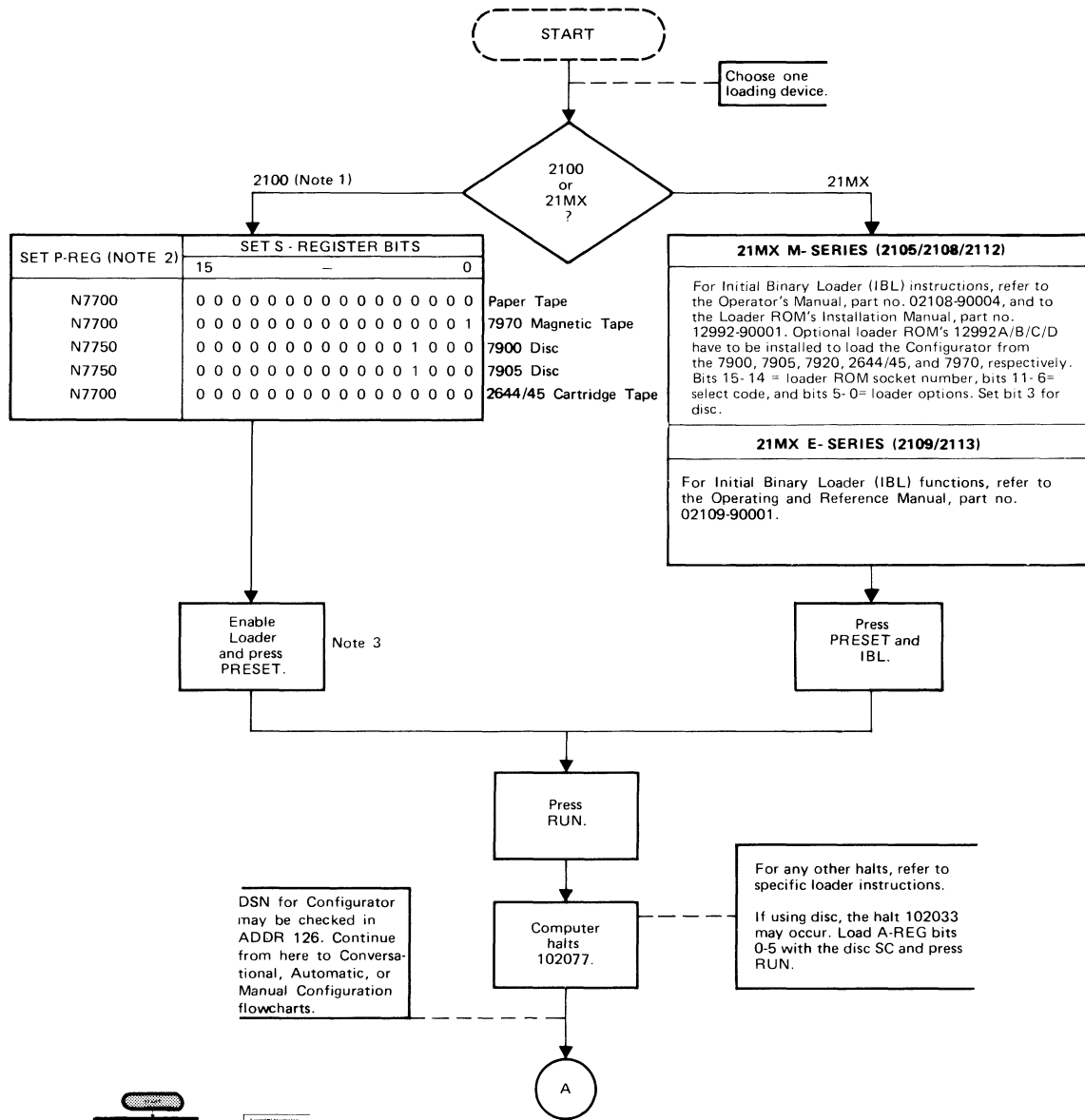

- NOTES: 1. HP 2100 or earlier (2114A/B, 2115A, 2116A/B/C).
 2. N = 0 for 4K, 1 for 8K, 2 for 12K, 3 for 16K, 4 for 20K, 5 for 24K, 6 for 28K, and 7 for 32K.
 3. For 2114A/B, press PRESET and LOAD simultaneously.

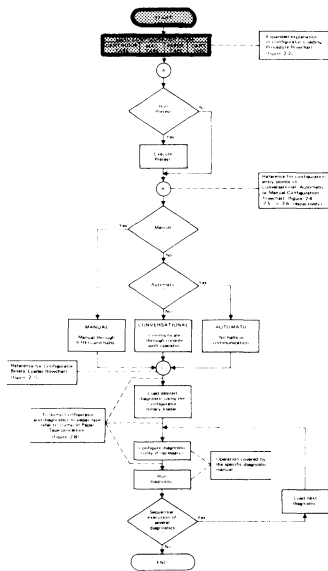

7132-2

Figure 2-2. Configurator Loading Procedure Flowchart

During the Paper Tape Dump routine, the SC of the punch is specified in the S-Register. (Refer to Dump routine in paragraph 2-11.)

S-REGISTER	INTERFACE TYPES & SELECT CODES	
	CONFIGURE (PRETEST)	DUMP ROUTINE
5-0	Console Select Code	Punch Select Code
11-6	Input Device Select Code	
14-12	Input Device Type	
15	Additional Parameters (in A- and B-Registers)	

2-5. A- AND B-REGISTERS

The two working registers have a special meaning when employed in conjunction with the Configurator Binary Loader. (See table 2-1.)

The A-Register has to be either loaded with the DSN of the diagnostic to be read into memory (and executed) or be cleared, in which case the next sequentially stored file in the input device will be loaded (and executed).

The B-Register has to be loaded with the bit pattern representing the appropriate diagnostic files to be loaded (and executed) following the diagnostic specified by the A-Register. B-Register bit 0 set will call for the execution of the diagnostic specified by the A-Register, bit 1 set will call for the execution of the next sequential diagnostic (file), etc. If the B-Register is cleared, the diagnostic specified in the A-Register will be loaded but not automatically executed. If any bit or bits are set in the B-Register, it will load and start execution of the selected diagnostic.

If both the A- and B-Register are not clear the Configurator will, after the specified diagnostics have been executed, return (rewind) to the first diagnostic specified and repeat the execution; i.e., loop on selected diagnostics.

Table 2-1. Summary of A- and B-Register Concept

B-REGISTER	A-REGISTER	
	CLEARED	SET TO DSN
Cleared	Load next file (diagnostic) and halt before execution.	Load specified diagnostic and halt before execution.
Set to bit pattern	Load next file and execute from there on each diagnostic specified in the B-Register one time.	Load specified diagnostic, execute from there on each specified diagnostic, and loop on all selected diagnostics.

This concept enables the user to concatenate his own Long Diagnostic with the desired diagnostics. The A- and B-Registers are set prior to Automatic configuration (see paragraph

2-8) and at the end of Manual configuration (halt 102077; see paragraph 2-9). In the Conversational mode, the user inputs the information via the terminal in response to the message: DSN (,SEQ.DIAG.EXECUT.) . . .

Example: A-REG → 101002: B-REG → 156235

 A-REG → 101002: Load Shift-Rotate Instruction Group Diagnostic.

 B-REG → 156235: Execute Shift-Rotate Instruction Group diagnostic, then load and execute sequentially the specified diagnostics.

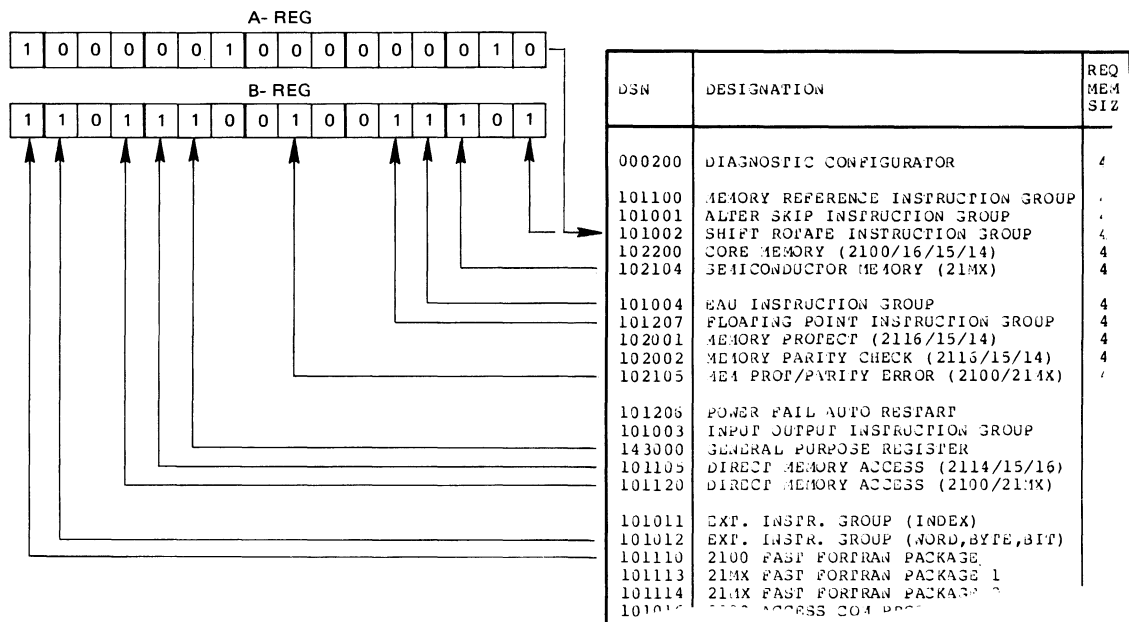

If in the above example the B-Register carries the value 156234, the Shift-Rotate Instruction Group diagnostic will not be executed.

After the 2100 Fast FORTRAN Package diagnostic has been executed and the diagnostic media is disc or magnetic tape, the diagnostic execution will restart. In case of cartridge tape or paper tape, an end-of-tape halt 106070 will be reached at an earlier point. This is because the cartridge tape number 1, with 17 files stored, reaches an EOF after the DMA/DCPC (2100/21MX) diagnostic. In case of paper tape, the first EOF will be reached after the semiconductor memory diagnostic.

2-6. CONFIGURATOR PRETEST

This procedure provides a means to execute the Pretest (which is loaded as part of the Configurator) prior to any configuration. It should be used whenever the CPU, memory, or

basic I/O is in question. When it is executed and an error halt 102066 is encountered, the operator should refer to the listing in appendix D. An error-reporting method via a console is not employed for the Pretest because it verifies the basic integrity of the CPU, base memory, and basic I/O, which is a prerequisite for transferring data to a console. The approximate run time for the Pretest is 10 seconds for 32K of memory.

The memory section of the Pretest checks only the base memory. The basic I/O section of the Pretest requires a standard* I/O interface board with its SC specified. If installed, disconnect WCS accessory. The Configurator Pretest flowchart is shown in figure 2-3.

2-7. CONVERSATIONAL CONFIGURATION

This procedure, which provides a fully conversational configuration from the console, must be used when a line printer is required**. It should also be used (if possible) when the operator is not familiar with the program operation. This procedure requires a console with one of the console interfaces listed in paragraph 1-2c. The Conversational Configuration flowchart is shown in figure 2-4.

All inputs are terminated by a CR (carriage return). If an entry is found incorrect prior to entering a CR, the input can be erased by entering a RUBOUT/DELETE. In reply, the program will issue a CR/LF (line feed).

2-8. AUTOMATIC CONFIGURATION

This procedure provides a means to configure the program and load a diagnostic with one input from the S-Register. There are no messages on the console. The program configures the appropriate drivers and then loads a diagnostic. Because there is no report of what is calculated by the program, the operator must assume that the calculations were made correctly. For Automatic Configuration, figure 2-5 shows the expansion of point B to point C from the Operational Overview flowchart.

*Standard I/O implies that the interface will respond to the assigned meaning of the I/O instructions and will also interrupt when control and flag are set and the interrupt system is enabled, (e.g., the 12665-60001, 59310-60101, 13175A, and 13178B interfaces cannot be used).

**Manual method may also be used to specify (configure) a line printer driver.

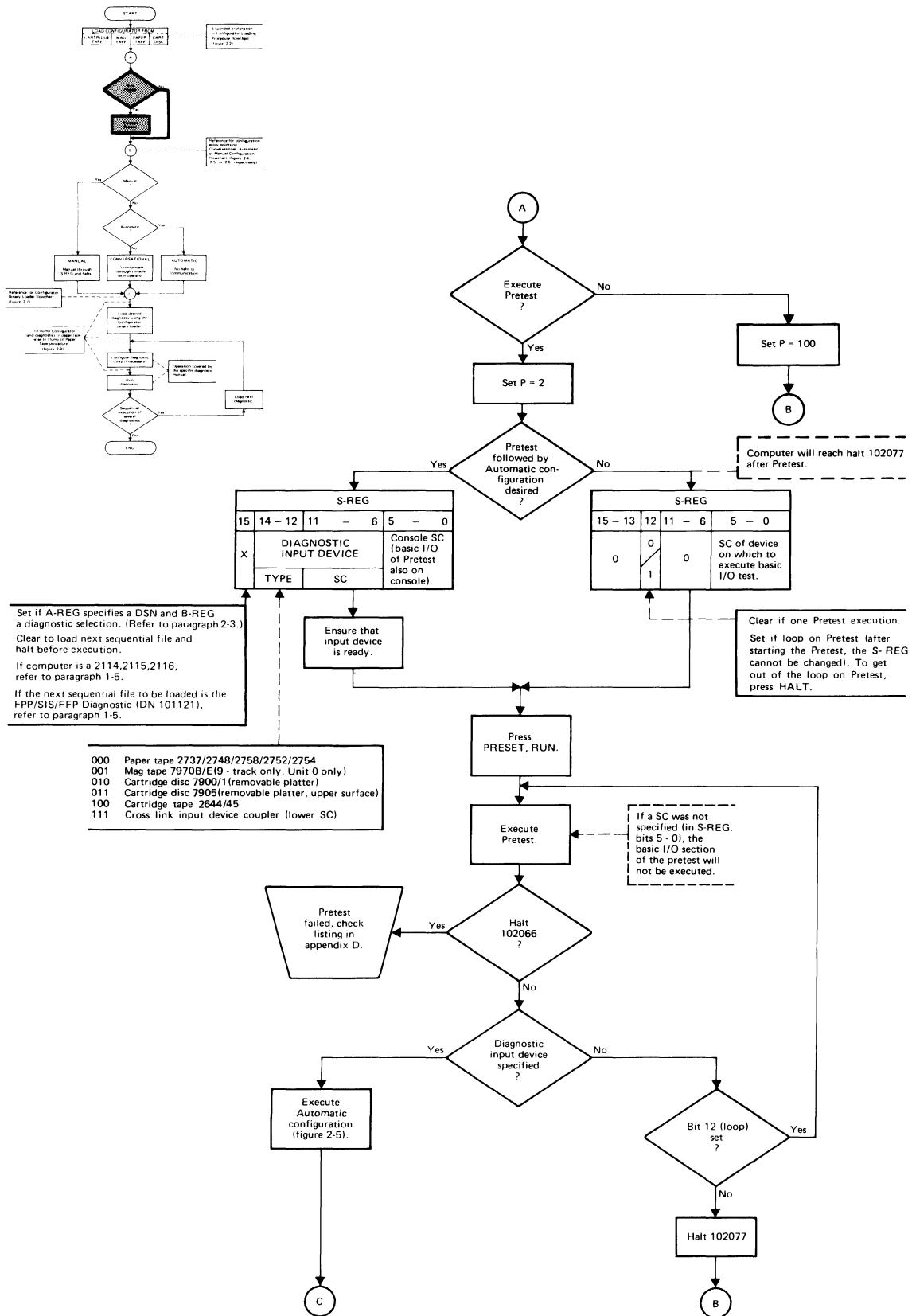

7132-3

Figure 2-3. Configurator Pretest Flowchart

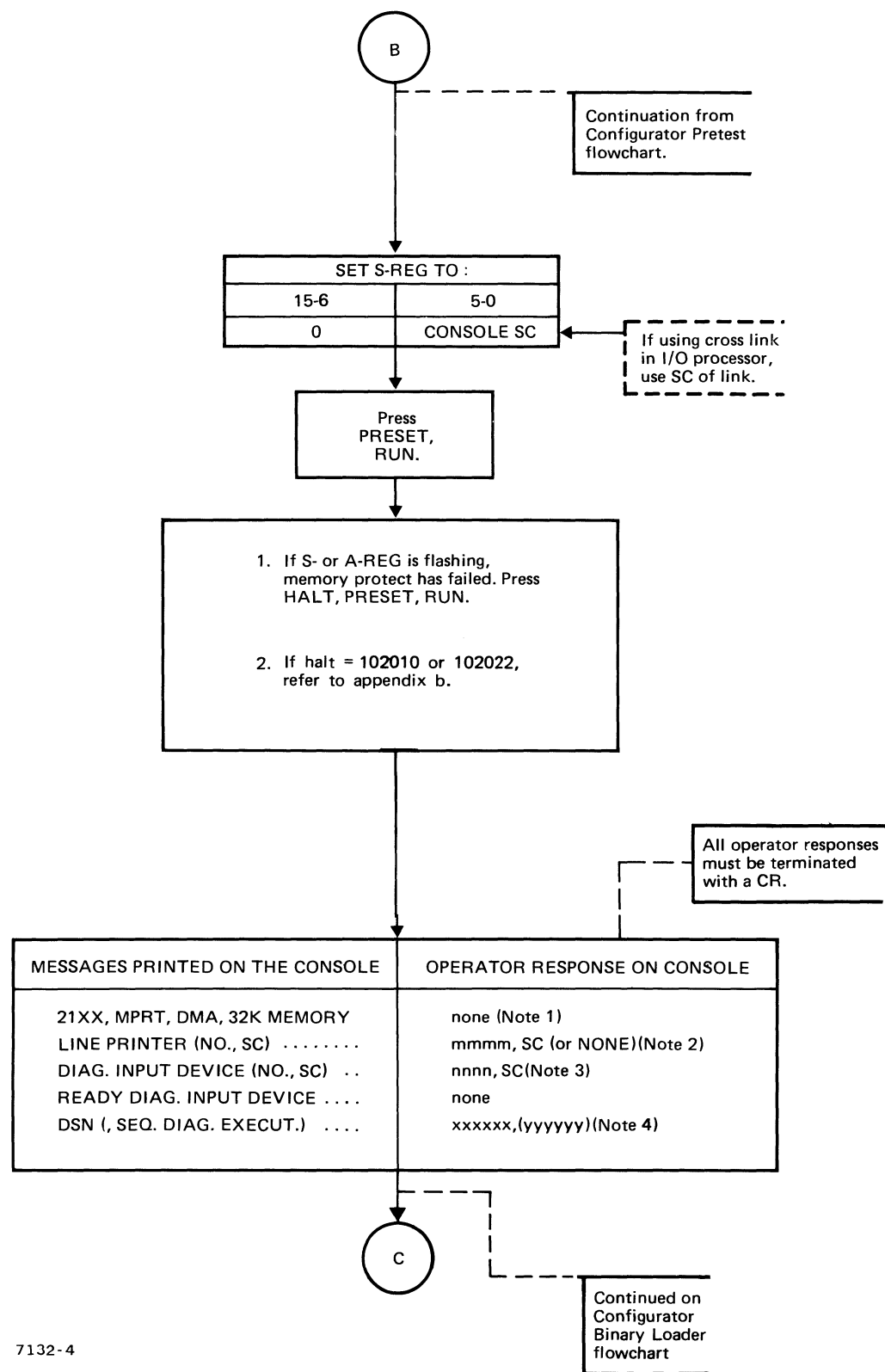

7132-4

Console Configuration Notes:

- No response to this message is required. The printout shows the parameters calculated by the program. They are listed for operator reference only. The actual printout will depend on the computer and its options:

21MX M, 21MX E, 2114, 2115, 2116, 2100	Computer type (21MX E refers to the E-Series and F-Series computer)
NO MPRT or MPRT	Memory protect
NO DMA or DMA	Direct Memory Access/Dual Channel Port Controller
32K MEMORY	Calculated base memory size, this does not include Memory Expansion Unit.
- Respond with the appropriate line printer model number and select code.

m m m m	= 2767, 2610, 2614, 2613, 2617, 2618, 2778, 2607 or 9866 NONE (if not available) LINK (if cross link is used)
SC	= Line printer select code.
- Respond with the appropriate device number (or LINK) and select code.

n n n n	= 2737, 2748 or 2758 Paper tape devices
	= 7970 Mag tape (9 - track only, Unit 0 only)
	= 7900 or 7901 Cartridge disc (removable platter only)
	= 7905/20 Cartridge disc (removable platter, upper surface)
	= 2644 or 2645 Cartridge tape (input 2645 if using 2648)
	= LINK (if cross link input device coupler is used)
SC	= select code of device (Lower SC in case of 2 SC)
- Respond with the desired Diagnostic Serial Number for the indicated value of xxxxxx. Refer to appendix A for a list of available diagnostics and their DSN's. If 0 is entered, the next consecutive binary file will be loaded from the input device.

The value yyyyyy may be entered for the octal equivalent of the binary bits selecting the desired diagnostic. (The program will load the values xxxxxx into the A-REG and yyyyyy into the B-REG and interpret as explained in paragraph 2-3.) If yyyyyy is not entered, the program sets the B-REG to 000000.

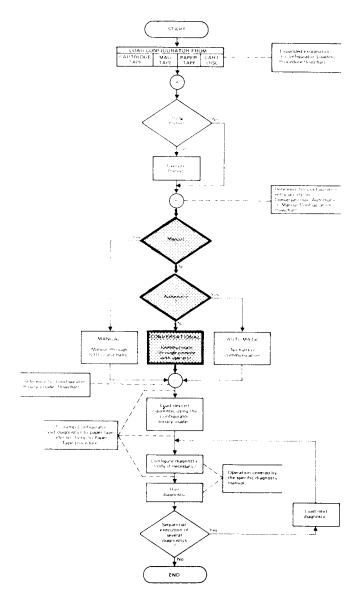

Figure 2-4. Conversational Configuration Flowchart

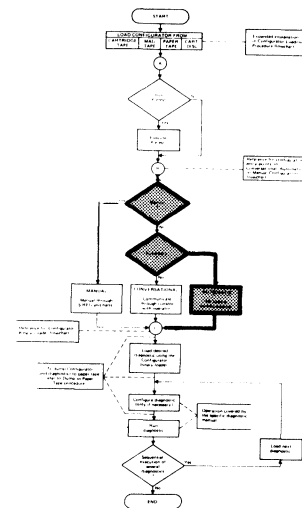
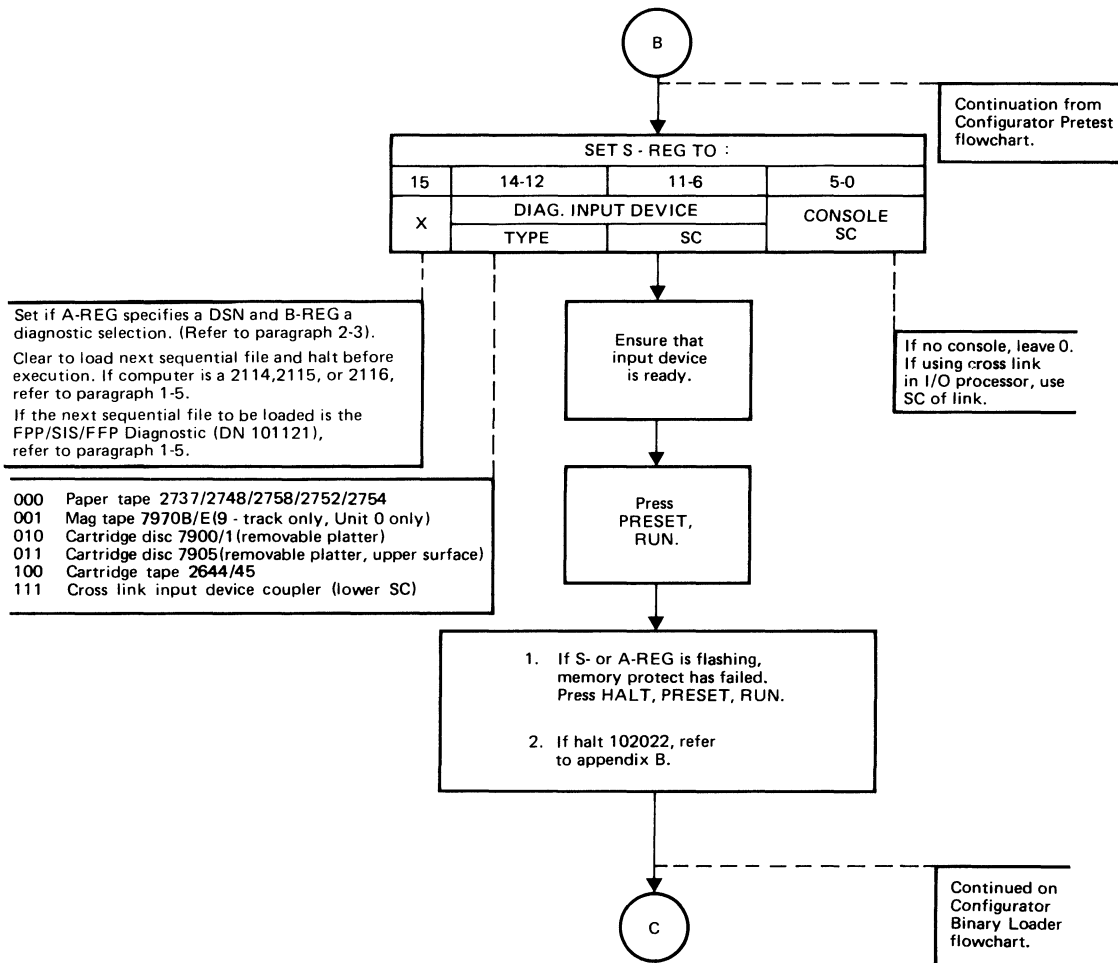

Figure 2-5. Automatic Configuration Flowchart

2-9. MANUAL CONFIGURATION

This procedure allows complete configuration through the S-Register via five halts. The program calculated parameters are displayed in the A- and S-Registers at the appropriate halts (0 and 3). When the operator presses RUN, the S-Register is read and the information supersedes the calculated value.* The basic halts and required inputs are:

HALTS	INPUT
102000	Computer type and options.
102001	Console interface type and select code.
102002	Line printer type and select code.
102003	Memory size.
102004	Diagnostic input device type and select code.
102077	Configuration complete.

After halt 102077, the program exits to the Configurator Binary Loader routine to accept a DSN in the A-Register and a sequential execution bit pattern in the B-Register. (Refer to paragraph 2-3b.) The Manual Configuration flowchart is shown in figure 2-6.

*If the S-Register is cleared at halt 102000, the program calculated parameters are used for configuration. This is ordinarily useful on the 2116 and 2115 where the S-Register is already cleared and the A-Register contains the correct parameters.

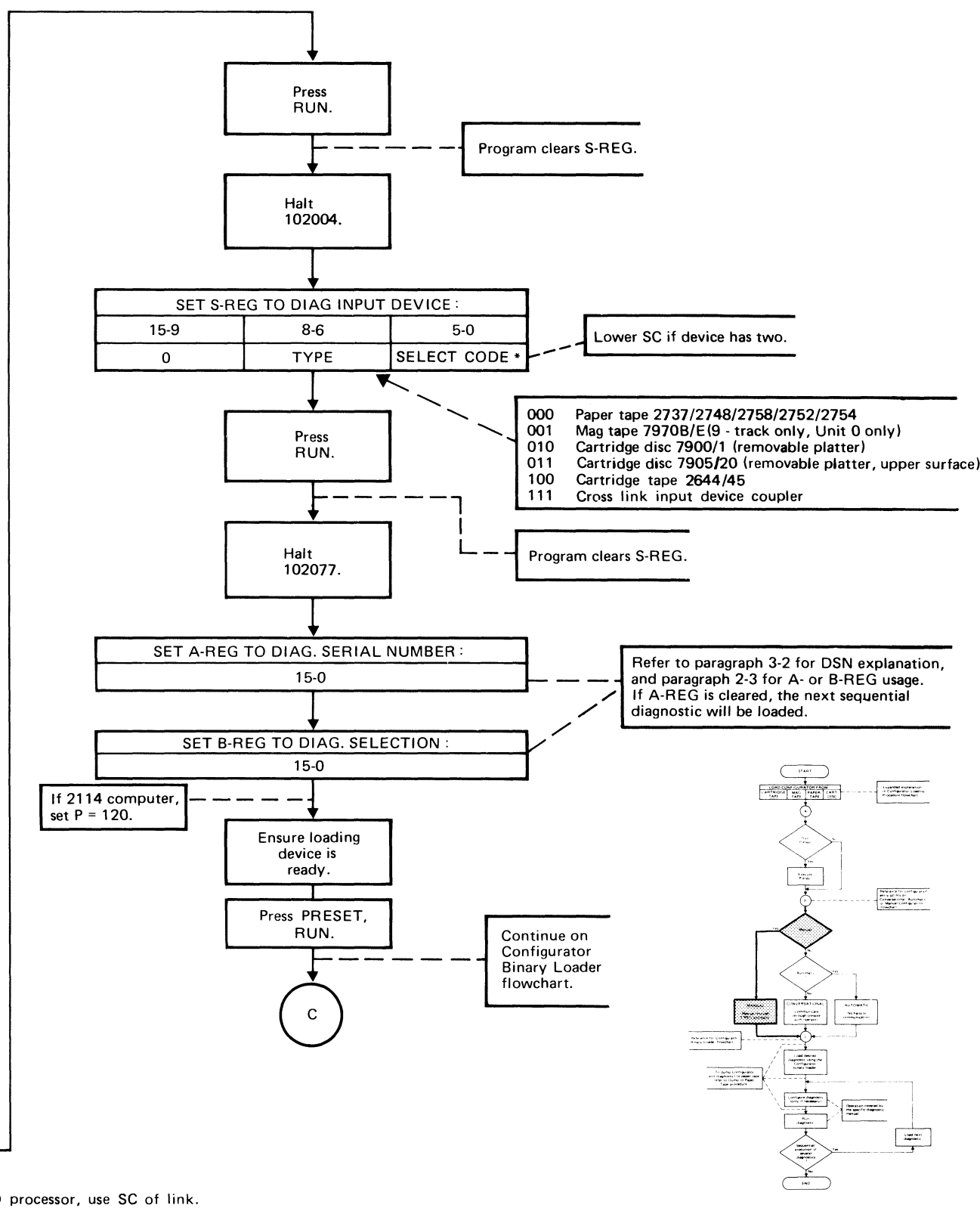
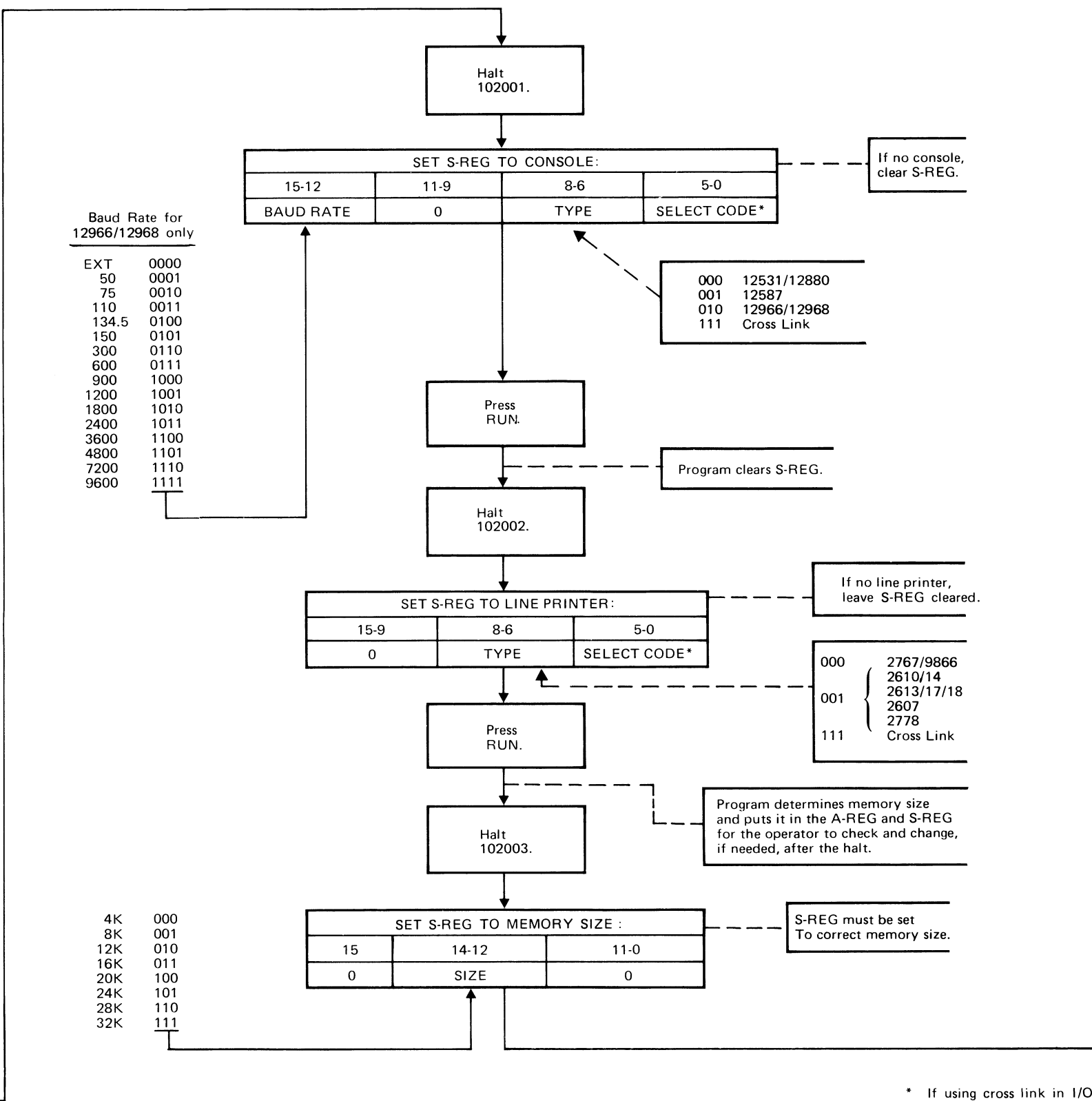
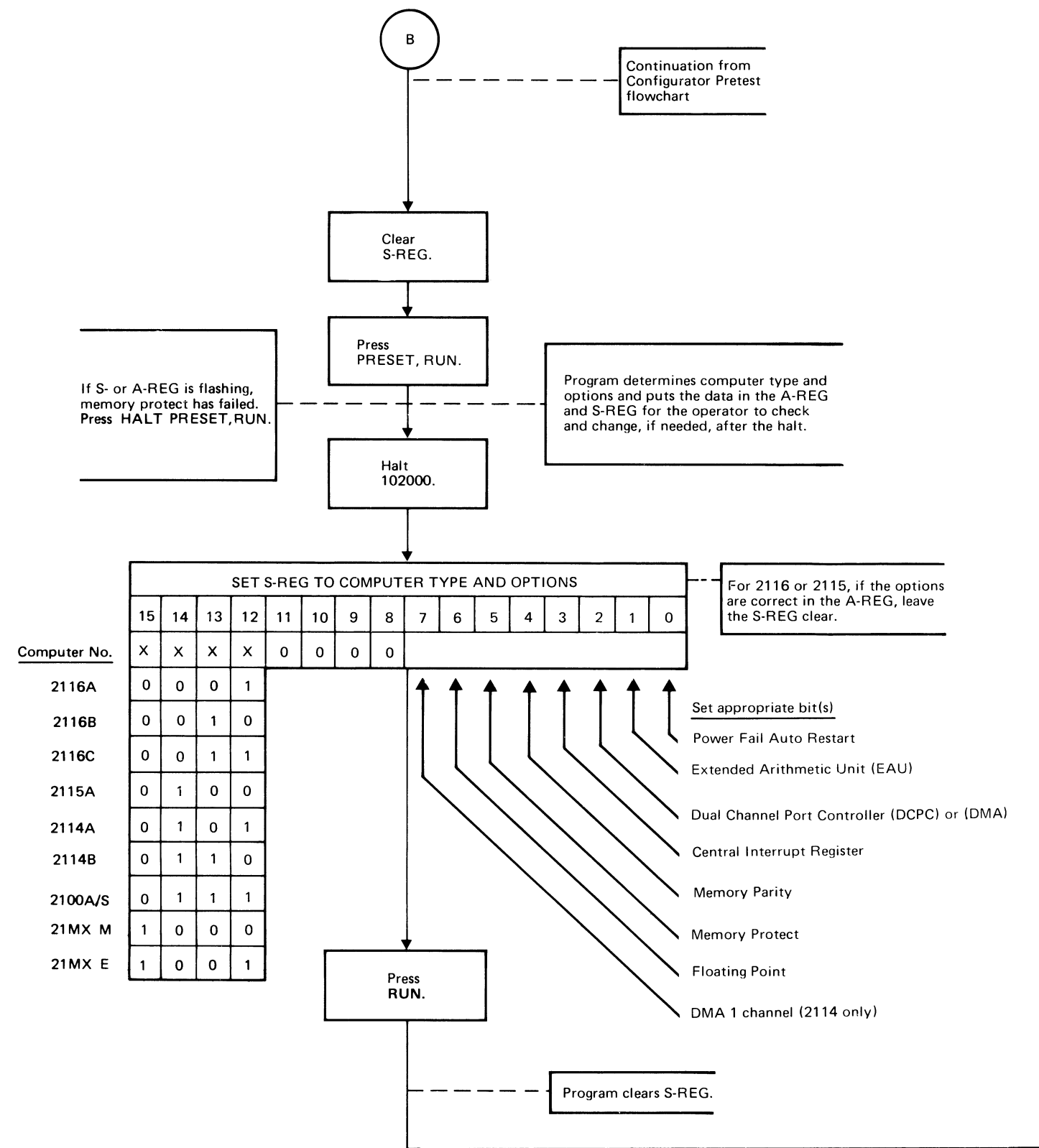

* If using cross link in I/O processor, use SC of link.

Figure 2-6. Manual Configuration Flowchart.

2-10. CONFIGURATOR BINARY LOADER

The Configurator Binary Loader is used to load diagnostic programs from the following devices:

- a. Paper Tape Readers; (Type 0)*: HP 2737, 2748, 2758, or teleprinter with paper tape reader.
- b. Magnetic Tape; (Type 1)* (requires DMA/DCPC), (Unit 0 only): HP 7970B/E 9-track only, interfaces = 13181, 13183, 18184.
- c. Cartridge Disc; (Types 2 and 3)* (requires DMA/DCPC), (Unit 0 only): HP 7900/1 Removable platter or HP 7905 Removable platter, upper surface.

The loader utilizes memory addresses N6300 through N6500 as a sector buffer for the disc loader. Diagnostics are loaded starting at address 130 and they may extend into the sector buffer area. Therefore, prior to loading the diagnostic, the upper memory boundary required to load the diagnostic is tested. If it reaches beyond N6300, the loader program will halt with 106073 displayed. Three possible routes can then be chosen by the operator as follows:

- (1) Load the desired diagnostic from a different device.
 - (2) Restart the loader and specify another DSN.
 - (3) Continue loading the diagnostic from disc but be aware that the overlaid buffer may cause unpredictable results.
- d. Cartridge Tape; (Type 4)*: HP 2644 or 2645 Terminal with 12966 interface.
 - e. Cross Loader Coupler; (Type 7)*: This is not a true loader but it allows the program to cross link to a loader driver in the central processor. The data checking (checksum and address violation) is done in the I/O processor (or slave) and only the device driver is used in the central processor. (See paragraphs C-10 through C-14.)

When using the loader, the files are searched until the specified Diagnostic Serial Number is found. If the specified DSN is not found, the program will halt 106070. When the Configurator Binary Loader has loaded the desired diagnostic and the B-Register was cleared, the program halts 102077 with the A-Register carrying the DSN contained in address 126.

To load the next consecutive binary file, clear the A- and B-Registers, set P=120, press PRESET and RUN.

All files are assumed to be absolute and the record length is not longer than 60 words including the count, address, and checksum. The flowchart for the Configurator Binary Loader is in figure 2-7.

*Type numbers refer to S-Register bits 14 through 12 in Automatic Configuration and S-Register bits 8 through 6 after halt 102004 is reached in Manual Configuration. They are also placed in memory location 111 with the select code.

2-11. DUMP TO PAPER TAPE

The Paper Tape Dump Routine can be employed to dump (a) the configured Configurator, (b) the configured Configurator and an unconfigured diagnostic, or (c) the configured Configurator and a configured diagnostic. The requirements are as follows:

- a. The paper tape loader must be specified during configuration as the diagnostic input device. The Configurator can therefore be loaded from any one of the specified input devices; the diagnostic, however, must be loaded from the paper tape reader. The Configurator must be configured manually.
- b. The dump device must be one of the following:
 - HP 2895, 2753 (punches)
 - HP 2752, 2754 (teleprinter tape punch device)
- c. The desired diagnostic should be loaded. It can also be configured. If a diagnostic is not loaded, only a copy of the Configurator Linkage Area, Utility Routines, and Drivers will be dumped to tape.

The Paper Tape Dump Routine flowchart is shown in figure 2-8.

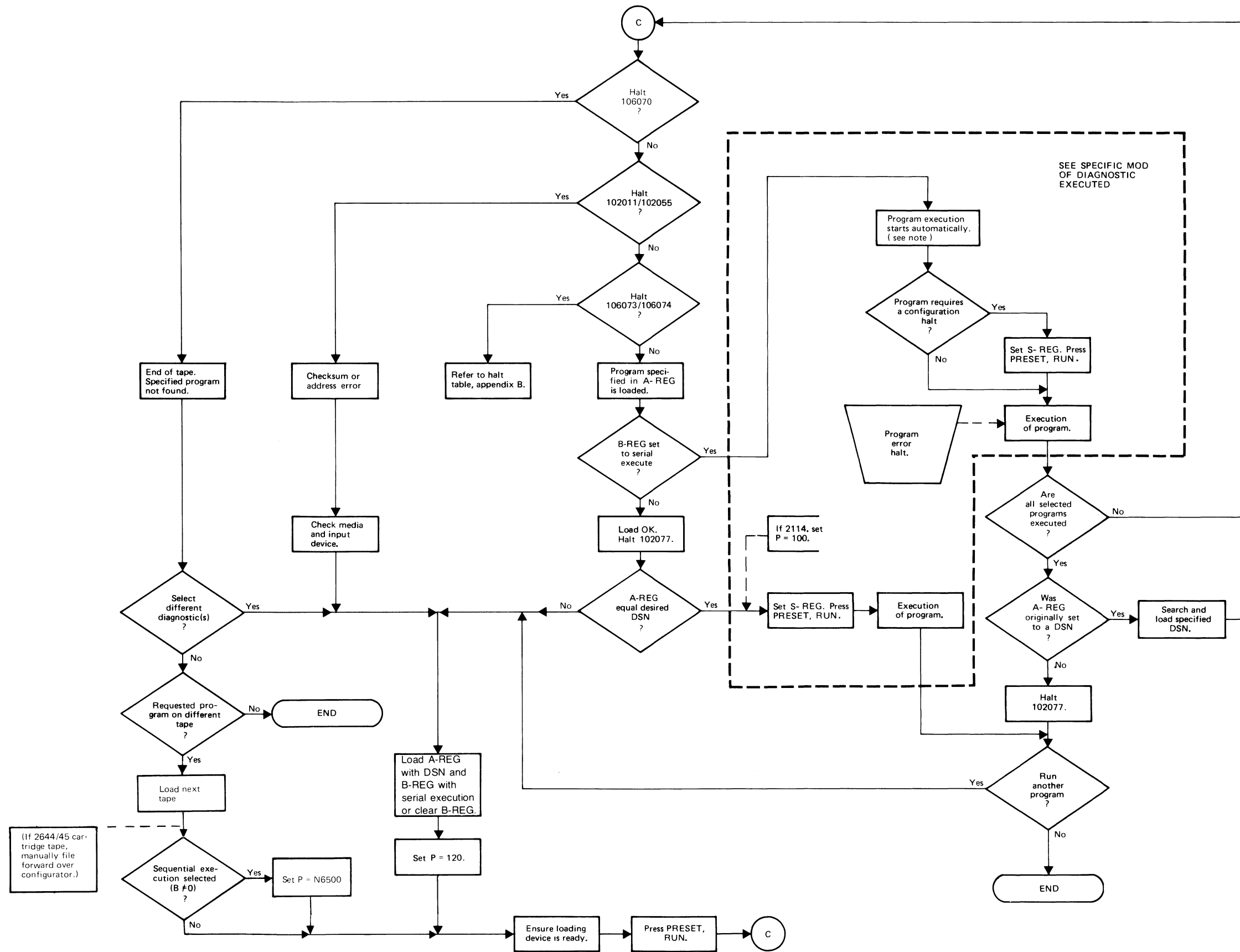

NOTE:
 If sequential execution of diagnostics has been selected and the diagnostic just loaded requires a configuration input an error halt (normally 102073) will be reached. Refer to the appropriate manual of diagnostics.

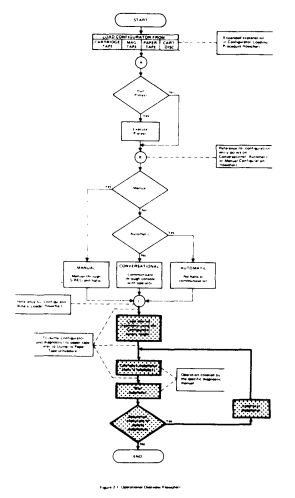
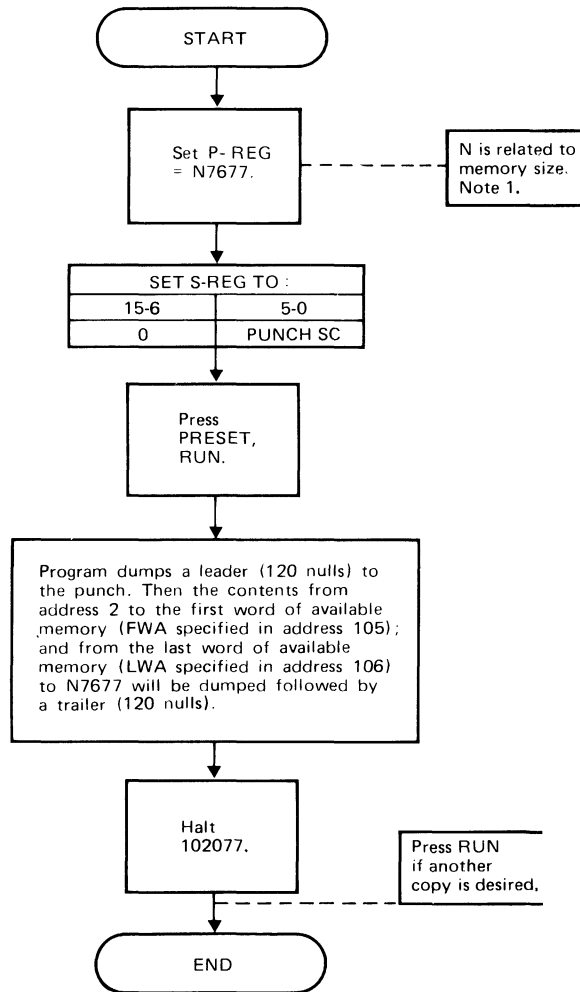

Figure 2-7. Configurator Binary Loader Flowchart



1. N=0 for 4K, 1 for 8K, 2 for 12K, 3 for 16K, 4 for 20K, 5 for 24K, 6 for 28K, and 7 for 32K.

Figure 2-8. Paper Tape Dump Routine Flowchart

PROGRAM DESCRIPTION

SECTION

III

3-1. GENERAL ORGANIZATION

The program is organized according to the memory map shown in figure 3-1. The map also includes the paragraph number that describes that area or function. The addresses shown in figure 3-1 are effective prior to configuration. Utility Routines and Configured Drivers are moved during configuration to the corresponding addresses in the last page of memory.

The area from 130 to N6477* may be overlaid when a diagnostic is loaded.

3-2. CONFIGURATOR LINKAGE AREA

This area, starting at address 100, is reserved by the Configurator for address links to utility routines and drivers. It also has data referenced by the diagnostic for computer parameters such as DMA/DCPC available, Memory Protect, memory size, etc. Refer to figure 3-2 for details of the linkage area.

When a diagnostic is loaded, it will overlay the JMP START (address 100), FWA (address 105), and DSN (address 126). The configurator loader does not protect the linkage area when a binary file is loaded.

The JMP START from address 100 establishes a common starting point for all diagnostics.

The FWA is the first unused memory location after the area occupied by the diagnostic. The area between the FWA and LWA is essentially unused memory. The LWA is established by the Configurator utility routines and is set to N6477 which is the last unused memory location before the routines. Some diagnostics use the area (FWA to LWA) as a buffer area. When dumping to paper tape, this area is not dumped; only locations 2 to FWA-1 and LWA+1 to N7677.

The DSN (Diagnostic Serial Number) is used to identify any diagnostic in memory. (See figure 3-3.) Each diagnostic is assigned a DSN when it is originally written and the revision number in the DSN is incremented each time the diagnostic is updated. The DSN allows the operator to check exactly what diagnostic and which revision of the diagnostic is loaded.

Any prereleased diagnostics or control programs will carry a pseudo-DSN of 177777. Figure 3-3 describes the DSN in detail. A diagnostic control program loads individual diagnostics, supplies parameters necessary for diagnostic execution, and/or monitors the sequential execution of discrete diagnostics.

*N is related to memory size. Also see figure 2-2, note 2.

3-3. PRETEST

The Pretest consists of a check to ensure that all major base set instructions work correctly. This is a cursory check and is not meant to replace any CPU Diagnostics. Each instruction is checked in a general manner and the entire base memory is checked with several patterns. When the Pretest passes, configuration can be performed with relative assurance that the basic computer is functional.

Four possible halts that can be encountered during the Pretest are as follows:

- a. When an error occurs (halt 102066) the operator must refer to the Pretest listing in appendix D. Any malfunctions must be corrected before continuing.

DESCRIPTION PARAGRAPH	STARTING MEMORY ADDRESS	FUNCTION
—	10	Trap cells for I/O select codes.
3-2	100	Configurator linkage area (figure 3-2).
3-3	130	Pretest part A.
	1400	Storage.
3-3	2000	Pretest part B.
3-4	3000	Establish computer parameters (memory size, DMA, MPRT, and computer type).
3-5		Configuration of drivers <ol style="list-style-type: none"> a. Console b. Line printer c. Diagnostic input device.
2-9		Manual configuration.
3-6		Table of drivers <ol style="list-style-type: none"> a. Consoles b. Line printers c. Diagnostic input devices.
3-7	N6500	Utility routines
3-14	N7000	Configured drivers <ol style="list-style-type: none"> a. Console driver b. Line printer driver c. Diagnostic input device driver.
	N7700	Basic Binary Loader (protected area or IBL).
<p>Note: The shaded area represents an area protected by the Configurator or an area within the BBL. An attempt to write into location N6500-N7777, when using the Configurator Binary Loader, will result in a halt 102055. Any programs loaded shall not overwrite the configurator linkage area (location 100-127), except locations, 100, 105, 116 and 126.</p>		

Figure 3-1. Memory Map

OCTAL ADDRESS	CONTENTS	MEANING
100	JMP START	GO TO START OF USER PROGRAM
101	NOP	RESERVED
102	DEF CNSLO	CONSOLE OUTPUT DRIVER
103	DEF LNPTR	LINE PRINTER DRIVER
104	DEF CNSLI	CONSOLE INPUT DRIVER
105 FWA	OCT 130	FIRST WORD OF AVAILABLE MEMORY
106 LWA	OCT 6477	LAST WORD OF AVAILABLE MEMORY
107	DEF LOADR	LOADER PROGRAM
110 TMC	DEC -200	1 MILLISEC. TIME COUNT
111	OCT 0	LOADER SELECT CODE
112	OCT 0	CONSOLE SELECT CODE (0=NOT AVAILABLE)
113	OCT 0	LINE PRINTER SELECT CODE (0=NOT AVAILABLE)
114	OCT 0	CONSOLE SELECT CODE (0=NOT AVAILABLE)
115	OCT 0	COMPUTER TYPE/OPTIONS
116	OCT 0	USER CARD TYPE AND SC
117	OCT 0	MEMORY SIZE
120	JSB 107B,1	GO TO LOADER PROGRAM
121	DEF TMR	1 MILLISEC. TIMER ROUTINE
122	DEF SWR	CHECK S-REG
123	DEF D2ASC	DECIMAL TO ASCII CONVERSION
124	DEF O2ASC	OCTAL TO ASCII CONVERSION
125	DEF ASC2N	ASCII TO NUMBER CONVERSION
126 DSN	OCT 000200	DIAGNOSTIC SERIAL NUMBER (CONF./REV. 1)
127	DEF FMTR	FORMATTER ROUTINE

REV B

Figure 3-2. Linkage Area

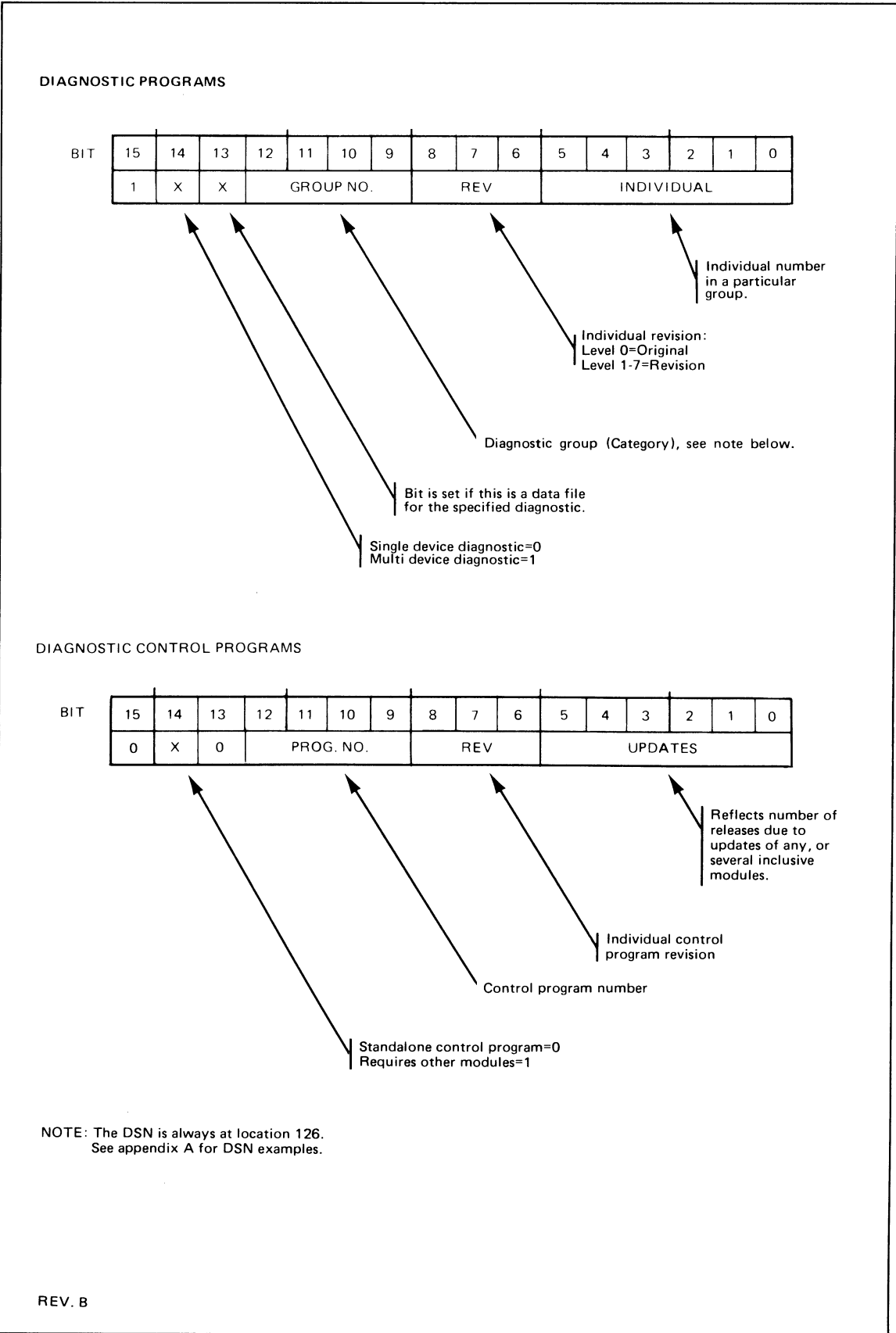

Figure 3-3. Diagnostic Serial Number (DSN)

- b. Halts 102020 and 102021 can occur only when testing a 2115 or 2116 computer where the S-Register cannot be modified under program control.
- c. Halt 102077 indicates successful Pretest execution.

3-4. COMPUTER PARAMETERS

The parameters calculated by the program are: computer type, DMA/DCPC, Memory Protect, and memory size. After being calculated, the computer type is used to look up the standard features, and the 1-millisecond timing constant. See figure 3-4 for computer type and options parameter details and figure 3-5 for memory size parameter details.

The calculated parameters are printed on the console device when Conversational Configuration is used. They are displayed in the A- and S-Registers when Manual Configuration is used. The display of parameters is for operator reference. If the parameters are wrong, it is a direct indication that the appropriate hardware has failed. The operator can correct the parameters by using Manual Configuration.

BIT	SET IF AVAILABLE	21MX E	21MX M	2100 A/S	2116 A/B/C	2115 A	2114 A/B
0	POWER FAIL AUTO RESTART	1	1	1 1	X X X	X	X X
1	EXTENDED ARITHMETIC UNIT	1	1	1 1	X X X	X	0 0
2	DMA/DCPC	X	X	X 1	X X X	X	0 X
3	CENTRAL INTERRUPT REG.	1	1	1 1	X* 1 1	X*	0 1
4	MEMORY PARITY CHECK	1	1	1 1	X X X	X	X X
5	MEMORY PROTECT	X	X	1 1	X X X	0	0 0
6	FLOATING POINT	1	1	X 1	0 0 0	0	0 0
7	DMA (1 CHANNEL ONLY)	0	0	0 0	0 0 0	0	0 1
8	RESERVED	0	0	0 0	0 0 0	0	0 0
9	RESERVED	0	0	0 0	0 0 0	0	0 0
10	RESERVED	0	0	0 0	0 0 0	0	0 0
11	RESERVED	0	0	0 0	0 0 0	0	0 0
12	} COMPUTER TYPE CODE }	1	0	1 1	1 0 1	0	1 0
13		0	0	1 1	0 1 1	0	0 1
14		0	0	1 1	0 0 0	1	1 1
15		1	1	0 0	0 0 0	0	0 0
NOTES: * = ON EARLIER MODELS THIS WAS AN OPTION X = OPTIONAL FEATURE AVAILABLE ON INDICATED COMPUTER. 0 = FEATURE NOT AVAILABLE ON INDICATED COMPUTER. 1 = STANDARD FEATURE ON INDICATED COMPUTER.							
LINKAGE AREA , ADDRESS 115.							

Figure 3-4. Computer Type and Options

In determining the computer type, it should be noted that the Configurator cannot distinguish between a 2115 and 2116 computer. The program will default to a 2115 calculation if the calculated memory size is 8K or less.

The S-Register will flash to indicate a hardware problem if one exists when checking for MPRT. The operator must press HALT, PRESET, RUN.

3-5. CONFIGURATION OF DRIVERS

The device drivers are written in such a way that only the basic hardware differences (in programming for each device and interface) are kept in a table. One table is used for each driver (console line printer and diagnostic input device). When a device is specified, the appropriate driver is moved from the table to the driver area of the Configurator. During the move the select code is set to the one specified by the operator. If a cross link is specified, the program will only configure the driver that has been loaded into the driver area. Refer to paragraph C-10. If no device is specified, a pseudo-driver is used so that if the diagnostic calls that driver no action is taken. The select code in the base page is also cleared to indicate that there is no device for that driver. When using Conversational or Automatic Configuration, the Configurator program determines the console interface type installed in the select code specified by the operator. If the Configurator is unsuccessful in determining the interface type, the program will halt 102022. The operator must enter a new select code or use Manual Configuration.

If a line printer was not specified during configuration, a pseudo-driver is used to call the console output driver. Therefore, in the event the diagnostic calls the line printer driver, the message will appear on the console.

The Configurator program asks for the device model number of the diagnostic input device and the select code during configuration. This data is used to look up the Binary Loader driver.

MEMORY SIZE	15	14 13 12	11-0
4K	0	0 0 0	0
8K	0	0 0 1	0
12K	0	0 1 0	0
16K	0	0 1 1	0
20K	0	1 0 0	0
24K	0	1 0 1	0
28K	0	1 1 0	0
32K	0	1 1 1	0

LINKAGE AREA, ADDRESS 117.

Figure 3-5. Memory Size

If the diagnostic input device model number cannot be found during input, the request line will be output repeatedly until a valid device number is entered. The same situation applies to the select code if the entry is greater than 77 or less than 10.

3-6. TABLE OF DRIVERS

The tables consist of console, line printer, and diagnostic input device drivers. The drivers in each table are written in a format that can be relocated to the driver routine area of memory during configuration. Primarily, the tables represent hardware differences (in programming) that must be known in order to interface with the driver routines.

The tables contain the following device drivers:

- a. Console:
 - 12531/12880
 - 12587
 - 12966
- b. Line printer:
 - 2767/9866
 - 2607/2610/2613/2614/2617/2618/2778
- c. Diagnostic Input Device:
 - Paper tape: 2737, 2748, 2758 (or teleprinter)
 - Magnetic tape: 7970B/E (9-track unit 0)
 - Cartridge disc: 7900/1 (unit 0, removable platter only)
 - Cartridge disc: 7905/20 (unit 0, removable platter, upper surface only)
 - Cartridge tape: 2644/2645 terminal

3-7. UTILITY ROUTINES

The following six paragraphs, listed below, describe the calling sequence for each of the Utility routines. The routines are generally required by diagnostics and are therefore incorporated in the configurator and are not overlaid by the diagnostic. These routines do not change the interrupt system and are interruptable at any point if the interrupt system is enabled.

- a. Timer or Wait Loop.
- b. S-REG Check.
- c. Decimal (Integer) to ASCII Conversion.
- d. Octal to ASCII Conversion.
- e. ASCII to Number (Binary) Conversion.
- f. Formatted Output.

The routines will not be directly used by the operator and are described here only to provide a broader scope of understanding the Configurator. The information can be used as a basis for creating individual diagnostics to run under the Configurator.

3-8. TIMER OR WAIT LOOP (ONE MILLISECOND)

CALLING SEQUENCE:

	LDA	TIME	NUMBER OF MILLISEC.
P	JSB	121B,I	GO TO TIMER
P+1	. . .		NORMAL RETURN
TIME	DEC	100	100 MILLISEC.

From P to P+1 = Time \times 1 millisecond.

3-9. S-REGISTER CHECK

CALLING SEQUENCE:

	LDB	SW10	SWITCH NUMBER
P	JSB	122B,I	CHECK IT
P+1	. . .		RETURN IF SWITCH(ES) IS ON
P+2	. . .		RETURN IF SWITCH IS OFF
SW10	OCT	002000	S-REG BIT 10

Upon entry the B-register contains the mask for the switch(es) of interest. The return is P+2 if the switch is off (or all off) or P+1 if any switches in question are on.

3-10. DECIMAL TO ASCII CONVERSION

CALLING SEQUENCE:

	CLE		START WITH UPPER HALF (CCE=LOWER*)
	LDA	DECNO	GET NUMBER FOR CONVERSION
	LDB	BFPTR	GET LOCATION IN BUFFER TO STORE THE CONVERTED NUMBER
	JSB	123B,I	MAKE CONVERSION
	. . .		NORMAL RETURN
DECNO	DEC	-32000	DECIMAL VALUE
BFPTR	DEF	***	POINTER TO BUFFER

The above call will result in the following:

BFPTR	—	3	
		2	0
		0	0

ASCII characters in memory.

Note: The routine does a right justify. The contents of the A- and B-Registers are lost.

3-11. OCTAL TO ASCII CONVERSION

CALLING SEQUENCE:

CLE		START WITH UPPER HALF (CCE= LOWER*)
LDA	OCTN	GET OCTAL NUMBER TO BE CONVERTED TO ASCII
LDB	BFPTR	GET LOCATION IN BUFFER TO STORE THE CONVERTED NUMBER
JSB	124B,I	MAKE CONVERSION
...		NORMAL RETURN

OCTN	OCT	034567
------	-----	--------

The above call will result in the following:

BFPTR	0	3	
	4	5	ASCII characters in memory.
	6	7	

Note: The routine does a right justify. The contents of the A- and B-Registers are lost.

3-12. ASCII TO BINARY CONVERSION

Converts a decimal or octal ASCII coded number in memory to a binary number and puts it in the A-Register. This routine will accept ASCII numbers only, 60 to 70 (octal). Any other characters will terminate the conversion or the routine will terminate after converting the sixth character.

CALLING SEQUENCE:

CLA		DECIMAL CONVERSION (CCA= OCTAL)
LDB	BFPTR	GET LOCATION IN BUFFER TO STORE THE CONVERTED NUMBER
CLE		START WITH UPPER HALF (CCE= LOWER*)
JSB	125B,I	MAKE CONVERSION
...		NORMAL RETURN

A-REG = CONVERTED NUMBER
 B-REG = BUFFER ADDRESS OF NEXT CHARACTER
 E-REG = UPPER/LOWER CHARACTER*

3-13. FORMATTED OUTPUT

To make it easier for programming, a simple format output call is available. This allows more room for the diagnostic.

*A four word buffer is required in this mode.

CALLING SEQUENCE:

CLA,	CLE (see note 1)	FORMAT STARTING
LDB	FMTA	POINTER TO FORMAT STRING
JSB	127B,I	CALL FOR OUTPUT
. . .		NORMAL RETURN
		A = 0 (OUTPUT COMPLETE)
		B = 0
		or
		A = 43 (# WAS REQUESTED)
		B = N.A.

FMTA	DEF	*+ 1
	ASC	7,FORMAT OUTPUT/

FORMAT CONTROL CHARACTERS

= NUMBER OUTPUT (See explanation — next page.)

/ = OUTPUT BUFFER WITH A CR-LF (OR PRINT IF OUTPUTTING TO LINE PRINTER)

← = OUTPUT BUFFER WITHOUT A CR-LF (OR SUPPRESS PRINT OF PENDING BUFFER, IF OUTPUTTING TO LINE PRINTER, UNTIL A /CONTROL CHARACTER IS ENCOUNTERED)

/ = or ← will cause a return with the original A- and B-REGS.

Note 1: CLA, CLE = OUTPUT TO CONSOLE
 CLA, CCE = OUTPUT TO LINE PRINTER

CALLING SEQUENCE: (number output)

This call can be used *only* in conjunction with the calling sequence above.

CCA	(see note 2)	OUTPUT NUMBER (OCTAL)
LDB	NMBR	GET NUMBER FOR OUTPUT
JSB	127B,I	CONTINUE FORMAT OUTPUT WITH NUMBER
. . .		RETURN

Note 2: CCA = OUTPUT NUMBER IN OCTAL
 CLA, INA = OUTPUT NUMER IN DECIMAL

If a call is made for a number output but a format has not been established, no action is taken and control is returned to P+ 1.

When the Format routine is started (A=0), the formatter moves each character in the string to a buffer. Each character is examined for the three control characters. If the character is #, a jump back to the caller is made. The program then indicates the type of conversion and passes the number back. The number is then converted and added to the buffer. The formatter will then continue to move each character until another control character is found. If the output string is larger than the format buffer, the buffer is output but no CR-LF or PRINT command is given. This process continues until a terminating control character is found (/ or ←).

*A four word buffer is required in this mode.

3-14. CONFIGURED DRIVERS

The following paragraphs (listed below) describe the calling sequence for each of the drivers (console, line printer, and diagnostic input device) available to the diagnostic program.

- a. Console Output.
- b. Console Input.
- c. Line Printer Output.
- d. Binary Loader.

3-15. CONSOLE OUTPUT

- a. Calling Sequence:

```

LDA  CNT    BUFFER COUNT
LDB  BUFA   BUFFER ADDRESS
JSB  102B,I CALL CONSOLE OUTPUT DRIVER
      .     RETURN WHEN COMPLETE
      .     A + B MEANINGLESS

```

- b. Count and Address:

The count is the positive number of 8-bit characters in the buffer. The address is the absolute memory location of the first byte in the buffer.

Note: The count cannot be negative, the results are unpredictable. A buffer count of zero will issue a CR-LF to the console.

- c. Call Console Output Driver:

This call will initialize an output of the specified buffer. The buffer is unpacked 8 bits (1 byte) at a time and transferred to the console. When the transfer has reached the count, a carriage return (CR) line feed (LF) is issued and the driver returns to the caller. If, during a transfer, a RUBOUT character is found, the driver will return to the caller at that point regardless of the remaining count, and no carriage return or line feed is issued.

3-16. CONSOLE INPUT

- a. Calling Sequence:

```

LDA  CNTMX  MAXIMUM INPUT COUNT
LDB  BUFA   BUFFER ADDRESS
JSB  104B,I CALL CONSOLE INPUT DRIVER
      .     RETURN WHEN COMPLETE
      .     A = NUMBER OF CHARACTERS INPUT BY THE
      .     OPERATOR
      .     B = MEANINGLESS

```

b. Count and Address:

The count is the positive maximum number of 8-bit characters to be input and loaded into the buffer. The address is the absolute memory location of the buffer.

Note: The count cannot be negative or zero, the results are unpredictable.

c. Call Console Input Driver:

This call will initialize an input from the console device. The characters will be put in the buffer in packed format (8-bit bytes) until the operator enters a CR (carriage return), or the buffer is filled.

Note: The driver automatically takes care of a RUBOUT (or delete) by the operator, issues a CR/LF, and resets the pointers to the start of the buffer. The driver requires only a CR to terminate an input.

d. Return:

When the operator enters a line feed, or the buffer is filled, the driver will return to the caller with the A-REG set to the input count.

3-17. LINE PRINTER OUTPUT

The same rules apply as for the Console Output driver except:

- a. The JSB is JSB 103B,I.
- b. A halt 106076 will occur if the line printer is not ready.

DIAGNOSTIC SERIAL NUMBERS

APPENDIX

A

Major groups are listed first (these are the prefixes for the DSN's). Specific DSN's follow this listing.

DSN	DIAGNOSTIC GROUP
000RXX	Control Programs
100RXX	Reserved
101RXX	CPU
102RXX	Memory
103RXX	Interface Cards
104RXX	Consoles
105RXX	Line Printers
106RXX	Tape Readers/Punches
107RXX	Plotters
110RXX	Reserved
111RXX	Discs
112RXX	Mag Tapes
113RXX	Card Readers
114RXX	Reserved
116RXX	Reserved
117RXX	Special Peripherals
177777	Prereleased program

Notes: See figure 3-3 in paragraph 3-2 for explanations.
R = revision.

All one's in the DSN represents a prereleased diagnostic or control program.

A diagnostic reference table is presented in table A-1, which lists the DSN's, diagnostic designations, part numbers, and date codes for the HP 2100 Series diagnostic media and the appropriate diagnostic reference manuals used with this Configurator.

24396A-F Products Cross Reference List

PRODUCT NO.	NAME	PARTS SUPPLIED WITH PRODUCT	
		SOFTWARE	MANUALS
24396A	DIAGNOSTIC LIBRARY ON PAPER TAPES	24296-60001 24396-12001 24396-12002 24396-12003 12943-16002 12943-16001 12907-16003 12977-16004 12977-16005 12740-16001 12929-16001 24395-16002 12539-16001 12936-16001 12908-16001 13197-16002 24335-16001 59310-16001 12587-16001 12920-16001 12920-16002 12621-16001 12622-16001 12967-16001 12966-16001 12968-16001 24340-16001 02618-16001 02631-16001 02635-16001 02608-16001 12996-16001 12732-16003 12960-16001 12962-16001 92900-16001 13181-16001 13184-16001 24296-16003 24296-16002 12597-16001 12560-16001 12924-16001 12989-16001 12531-16001 24351-16001 24360-16001	24396-14001 24396-14002 24396-14003 24396-14004
24396B	DIAGNOSTIC LIBRARY ON 7900/01 CARTRIDGE DISC	24396-13001	
24396C	DIAGNOSTIC LIBRARY ON 7905 CARTRIDGE DISC	24396-13101	
24396D	DIAGNOSTIC LIBRARY ON 7970B MAGNETIC TAPE (800 BPI)	24396-13501	
24396E	DIAGNOSTIC LIBRARY ON 7970E MAGNETIC TAPE (1600 BPI)	24396-13601	
24396F	DIAGNOSTIC LIBRARY ON 2644/45 MINICARTRIDGES	24396-13301 24396-13302 24396-13303 24396-13304 24396-13305 24396-13306 24396-13307	
*The diagnostics and control programs listed in this reference table are stored on the appropriate media in the sequence specified by the table. This does not imply that a specific system delivered to a user is compatible with all the hardware listed in this table.			

Table A-1. Diagnostic Reference Table for HP 24396A-F Products

DSN	DESIGNATION	REQ MEM SZ	SINGLE FILE PAPER TAPE			MULTIPLE FILES																	
			BINARY	D.C.	MANUAL	PAPER TAPE		2644/45 CARTRIDGE		DISC/MAG TAPE		MANUAL VOL.											
						BINARIES	D.C.	BINARIES	D.C.	BINARIES	D.C.												
000200	DIAGNOSTIC CONFIGURATOR	4K	24296-60001	1627	02100-90157	24296-60001	1627	THE DIAGNOSTIC CONFIGURATOR IS THE FIRST FILE ON EVERY CARTRIDGE TAPE, DISC AND MAG TAPE.															
101100	MEMORY REFERENCE INSTRUCTION GROUP	4K	24315-16001	1624	02100-90218	24396-12001	1644																
101001	ALTER SKIP INSTRUCTION GROUP	4K	24316-16001	1431	02100-90211																		
101002	SHIFT ROTATE INSTRUCTION GROUP	4K	24317-16001	1431	02100-90212																		
102200	CORE MEMORY (2100/16/15/14)	4K	24323-16001	1624	02100-90219																		
102104	SEMICONDUCTOR MEMORY (21MX)	4K	24395-16001	1644	24395-90001																		
101004	EAU INSTRUCTION GROUP	4K	24319-16001	1431	02100-90214	24396-12002	1901	24396-13301 1901															
101207	FLOATING POINT INSTRUCTION GROUP	4K	24320-16001	1551	24320-90001																		
102305	MEM PROT/PARITY ERROR (2100/21MX)	4K	12892-16001	1705	12892-90005																		
101206	POWER FAIL AUTO RESTART	4K	24321-16001	1635	02100-90216	24396-12003	1901																
141103	I/O INSTR-GROUP I/O CHANNEL EXTENDER	8K	24318-16001	1810	02100-90213																		
143300	GENERAL PURPOSE REGISTER	4K	24391-16001	1813	24391-90001																		
101220	DIRECT MEMORY ACCESS (2100/21MX)	4K	24322-16002	1705	24322-90002																		
101011	EXT. INSTR. GROUP (INDEX)	4K	12943-16002	1432	12943-90004	24396-13302 1926																	
101112	EXT. INSTR. GROUP (WORD,BYTE,BIT)	4K	12943-16001	1728	12943-90004																		
101110	2100 FAST FORTRAN PACKAGE	4K	12907-16003	1632	12907-90003																		
101213	M/E-Series FAST FORTRAN PACKAGE 1	4K	12977-16004	1822	12977-90002																		
101114	M/E-Series FAST FORTRAN PACKAGE 2	4K	12977-16005	1632	12977-90002																		
101121	F-Series FPP/SIS/FFP	16K	12740-16001	1926	12740-90004																		
102103	MEMORY EXPANSION UNIT	16K	12929-16001	1830	12929-90003							24396-14002											
102006	SEMICOND MEMORY, MICROCODED F.21MX	4K	24395-16002	1644	24395-90003																		
103301	TIME BASE GENERATOR	4K	12539-16001	1830	12539-90011																		
103115	12936 PRIVILEGED INTERRUPT	4K	12936-16001	1643	12936-90003																		
103105	12908/12978 WCS 256 W.	4K	12908-16001	1502	12908-90013																		
103023	13197 WCS 1024 W.	4K	13197-16002	1640	13197-90002																		
103207	12889 HARDWIRED SERIAL INTERFACE	4K	24335-16001	1717	02100-90169																		
103122	59310 INTERF. BUS INTERFACE	4K	59310-16001	1728	59310-90061																		
103003	12587 ASYN. DATA SET INTERF.	8K	12587-16001	1552	12587-90013																		
103110	12920 ASYN. MULTIPLEXER (DATA)	4K	12920-16001	1805	12920-90009																		
103011	12920 ASYN. MULTIPLEXER (CNTL)	4K	12920-16002	1444	12920-90009																		
103012	12621 SYNC. DATA SET (RECEIVE)	4K	12621-16001	1532	12621-90008	24396-13303 1830																	
103013	12622 SYNC. DATA SET (SEND)	4K	12622-16001	1532	12622-90008																		
103116	12967 SYNC. INTERFACE	4K	12967-16001	1438	12967-90001																		
103017	12966 ASYN. DATA SET	8K	12966-16001	1519	12966-90004																		
103121	12968 ASYN. COMM. INTERFACE	4K	12968-16001	1602	12968-90003																		
103024	12821 ICD DISC INTERFACE	8K	12821-16001	1928	12821-90002																		
105102	2607 LINE PRINTER	4K	24340-16001	1446	12987-90004							24396-13304 1928											
145103	2613/17/18 LINE PRINTER	4K	02618-16001	1633	02618-90006																		
105106	2631 PRINTER	8K	02631-16001	1913	02631-90906																		
105107	2635 PRINTING TERMINAL	8K	02635-16001	1913	02635-90906																		
105105	2608 LINE PRINTER	8K	02608-16001	2026	02608-90906																		
105104	9866 LINE PRINTER	4K	12996-16001	1541	12996-90001																		
111104	12732 FLEXIBLE DISC SUBSYSTEM	8K	12732-16003	1708	12732-90003	24396-13305 2026																	
151302	7900/01 CARTRIDGE DISC	8K	12960-16001	1805	12960-90003																		
151403	7905/06/20/25 DISC	16K	12962-16001	1805	12962-90001																		
104117	92900 TERMINAL SUBSYS (3070,40280)	8K	92900-16001	1814	92900-90003																		
112200	9-TRACK MAG TAPE (7970, 13181/3)	8K	13181-16001	2040	13181-90095													24396-13306 1901					
112102	7/9 TRACK MAG TAPE (13184 INTF)	8K	13184-16001	1629	13184-90008																		
010000	DIAGNOSTIC CROSS LINK	4K	24296-16003	1627	02100-90157																		
011000	7900/05/20 DISC INITIALIZATION	4K	24296-16002	1627	02100-90157																		
146200	PAPER TAPE READER-PUNCH	4K	12597-16001	1725	12597-90031																		
107000	DIG. PLOTTER INTERFACE (CALCOMP)	4K	12560-16001	1540	12560-90029																		
113100	2892 CARD READER	4K	12924-16001	1537	12924-90006																		
113001	2894 CARD READER PUNCH	8K	12989-16001	1728	12989-90001																		
104003	TELEPRINTER	4K	12531-16001	1509	12531-90042																		
104007	2615 VIDEO TERMINAL	4K	24351-16001	1347	02615-90002																		
103006	12909B PROM WRITER	4K	24360-16001	1420	24360-90001	24396-13307 2040																	

Table A-2. Diagnostic Reference Table for Part no. 24998-14002

DSN	DESIGNATION*	REQ MEM SIZ	SINGLE FILE PAPER TAPE			MULTIPLE FILES			
			BINARY	D.C.	MANUAL	2645 CARTRIDGE BINARIES	D.C.		
000200	DIAGNOSTIC CONFIGURATOR	4K	24296-60001	1627	02100-90157	} 24998-13301	1926		
101100	MEMORY REFERENCE INSTRUCTION GROUP	4K	24315-16001	1624	02100-90218				
101001	ALTER SKIP INSTRUCTION GROUP	4K	24316-16001	1431	02100-90211				
101002	SHIFT ROTATE INSTRUCTION GROUP	4K	24317-16001	1431	02100-90212				
102104	SEMICONDUCTOR MEMORY (21MX)	4K	24395-16001	1644	24395-90001				
101004	EAU INSTRUCTION GROUP	4K	24319-16001	1431	02100-90214				
101207	FLOATING POINT INSTRUCTION GROUP	4K	24320-16001	1551	24320-90001				
102305	MEM PROT/PARITY ERROR (2100/21MX)	4K	12892-16001	1705	12892-90005				
101206	POWER FAIL AUTO RESTART	4K	24321-16001	1635	02100-90216				
141103	I/O INSTR GROUP I/O CHANNEL/EXTENDER	8K	24318-16001	1810	02100-90213				
143300	GENERAL PURPOSE REGISTER	4K	24391-16001	1813	24391-90001				
101220	DIRECT MEMORY ACCESS (2100/21MX)	4K	24322-16002	1705	24322-90002				
101011	EXT. INSTR. GROUP (INDEX)	4K	12943-16002	1432	12943-90004				
101112	EXT. INSTR. GROUP (WORD,BYTE,BIT)	4K	12943-16001	1728	12943-90004				
101213	M/E-Series FAST FORTRAN PACKAGE 1	4K	12977-16004	1822	12977-90002				
101114	M/E-Series FAST FORTRAN PACKAGE 2	4K	12977-16005	1632	12977-90002				
101121	F-Series FPP/SIS/FFP	16K	12740-16001	1926	12740-90004			} 24998-13302	1926
102103	MEMORY EXPANSION UNIT	16K	12929-16001	1830	12929-90003				
102006	SEMICOND MEMORY, MICROCODED F.21MX	4K	24395-16002	1644	24395-90003				
103301	TIME BASE GENERATOR	4K	12539-16001	1830	12539-90011				
103023	13197 WCS 1024 W.	4K	13197-16002	1640	13197-90002	} 24998-13303	1928		
103110	12920 ASYN. MULTIPLEXER (DATA)	4K	12920-16001	1805	12920-90009				
103011	12920 ASYN. MULTIPLEXER (CNTL)	4K	12920-16002	1444	12920-90009				
103012	12621 SYNC. DATA SET (RECEIVE)	4K	12621-16001	1532	12621-90008				
103013	12622 SYNC. DATA SET (SEND)	4K	12622-16001	1532	12622-90008				
103116	12967 SYNC. INTERFACE	4K	12967-16001	1438	12967-90001				
103017	12966 ASYN. DATA SET	8K	12966-16001	1519	12966-90004				
104003	TELEPRINTER	4K	12531-16001	1509	12531-90042				
103207	12889 HARDWIRED SERIAL INTERFACE	4K	24335-16001	1717	02100-90169				
103122	59310 INTERF. BUS INTERFACE	4K	59310-16001	1728	59310-90061				
103024	12821 ICD DISC INTERFACE	8K	12821-16001	1928	12821-90002	} 24998-13304	2026		
105102	2607 LINE PRINTER	4K	24340-16001	1446	12987-90004				
145103	2613/17/18 LINE PRINTER	4K	02618-16001	1633	02618-90006				
105106	2631 PRINTER	8K	02631-16001	1913	02631-90906				
105107	2635 PRINTING TERMINAL	8K	02635-16001	1913	02631-90906				
105105	2608 LINE PRINTER	8K	02608-16001	2026	02608-90906				
105104	9866 LINE PRINTER	4K	12996-16001	1541	12996-90001	} 24998-13305	1822		
111104	12732 FLEXIBLE DISC SUBSYSTEM	8K	12732-16003	1708	12732-90003				
151302	7900/01 CARTRIDGE DISC	8K	12960-16001	1805	12960-90003				
151403	7905/06/20/25 DISC	16K	12962-16001	1805	12962-90001	} 24998-13306	2040		
104117	92900 TERMINAL SUBSYS (3070,40280)	8K	92900-16001	1814	92900-90003				
112200	9-TRACK MAG TAPE (7970, 13181/3)	8K	13181-16001	2040	13181-90095				
146200	PAPER TAPE READER-PUNCH	4K	12597-16001	1725	12597-90031				
113100	2892 CARD READER	4K	12924-16001	1537	12924-90006				
010000	DIAGNOSTIC CROSS LINK	4K	24296-16003	1627	02100-90157				
011000	7900/05/20 DISC INITIALIZATION	4K	24296-16002	1627	02100-90157				

Note: Part no. 24998-14002 consists of the 6 cartridge tapes 24998-13301, 24998-13302, 24998-13303, 24998-13304, 24998-13305 and 24998-13306 plus all manuals listed in the table.

*The diagnostics and control programs listed in this reference table are stored on the appropriate media in the sequence specified by the table. This does not imply that a specific system delivered to a user is compatible with all the hardware listed in this table.

CONFIGURATOR HALT CODE SUMMARY

APPENDIX

B

HALT CODE	REASON/RESPONSE
102000	<p>Manual Configuration was selected (S-REG originally cleared). The program is requesting the computer type and options. The program calculated type and options are stored in the A-REG and S-REG (S-REG only if the computer being used is a HP 21MX, 2100A/S or 2114A/B).</p> <p>Refer to figure 3-4 and paragraph 3-4 and if necessary, change the S-REG to the correct, or desired value and press RUN.</p>
102001	<p>Manual Configuration was selected (S-REG originally cleared). The program is requesting the console interface type and select code. The A-REG and S-REG are cleared by the program prior to the halt.</p> <p>Refer to figure 2-6 for the correct bit setting, set the S-REG accordingly and press RUN. If no console device is available ensure that the S-REG is cleared and then press RUN.</p>
102002	<p>Manual Configuration was selected (S-REG originally cleared). The program is requesting the line printer type and select code. The A-REG and S-REG are cleared prior to the halt.</p> <p>Refer to figure 2-6 for the correct bit setting, set the S-REG accordingly and press RUN. If no line printer is available ensure that the S-REG is cleared then press RUN.</p>
102003	<p>Manual Configuration was selected (S-REG originally cleared). The program is requesting the memory size. The program calculated size is stored in the A-REG and S-REG (S-REG only if the computer being used is a 21MX, 2100A/S or 2114A/B).</p> <p>Refer to figure 3-5 and paragraph 3-4 and if necessary, change the S-REG to correct, or desired value then press RUN.</p>
102004	<p>Manual Configuration was selected (S-REG originally cleared). The program is requesting the diagnostic input device type and select code. The A-REG and S-REG are cleared by the program prior to the halt.</p> <p>Refer to figure 2-6 for the correct bit setting, set the S-REG accordingly then press RUN.</p>
102010	<p>Illegal select code (<10) for diagnostic input device or console was chosen. Restart at P = 100 for configuration or P = 2 for Pretest.</p> <p>(If halt occurs during disc initialization, there was no console specified and program cannot be run.)</p>

HALT CODE	REASON/RESPONSE
102011	Checksum error during the loading of a binary file.
102020	Pretest halt for 2115 or 2116 computer. Set S-REG to 177777 and press RUN.
102021	Pretest halt for 2115 or 2116 computer. Clear S-REG and press RUN.
102022	<p>Conversational or Automatic Configuration was selected and the console interface type could not be determined by the configurator from the select code input to the S-REG.</p> <p>Check the S-REG for the correct select code:</p> <ol style="list-style-type: none"> a. Change it if incorrect, then press RUN. b. If the select code is correct check the interface type. If it is not a 12531, 12880, 12587, 12966 or 12968, no driver is available and no console can be specified. c. If the select code and type are correct there is a possible problem on the interface board and the Manual Configuration must be used. The diagnostic for the console or interface should be run.
102033	<p>The disc boot has been loaded and executed. During execution the boot could not find the DMA/DCPC control word in upper memory (for the select code).</p> <p>Load A-REG bits 5-0 with the disc select code and press RUN.</p>
102044	Disc did not respond with a flag. Restart program.
102045	Disc not ready or a hardware failure has occurred. Press RUN to try operation again.
102055	Address violation during the loading of a binary file.
102066	Pretest failed. Refer to M-REG for memory location in Pretest and appendix D for program listing.
102071	<p>Manual Configuration was selected (S-REG originally cleared) and the console type input by the operator was not valid.</p> <ol style="list-style-type: none"> a. To leave a pseudo-driver in place, press RUN or b. Restart configuration.
102072	<p>An invalid loader type has been specified during configuration.</p> <ol style="list-style-type: none"> a. Press RUN to leave a pseudo-loader in the driver area or b. Restart configuration.

HALT CODE**REASON/RESPONSE**

102077	<p>End-of-operation.</p> <ol style="list-style-type: none"> Disc Boot. Disc Initialization. Paper Tape Dump. Load Complete. Configuration Complete (Manual). Pretest Complete.
106070	<p>“End-of-Files” was reached during a diagnostic load operation. The specified DSN was not found.</p> <p>If a different diagnostic(s) selection on the current tape is desired:</p> <ol style="list-style-type: none"> Load the A-REG with a new DSN. Clear the B-REG if sequential execution is not desired, otherwise set B-REG to appropriate sequential selection. Ready input device, set P-REG = 120, press PRESET and RUN. <p>If the diagnostic(s) originally selected is on a different tape:</p> <ol style="list-style-type: none"> Load the new tape. (If a 2644/45 cartridge tape, manually file forward over the configurator.) If sequential execution was selected ($B \neq 0$) set P-REG = N6500. Ready input device, press PRESET and RUN.
106071*	<p>No console was specified during configuration. A pseudo-driver was configured in place of the console driver and a request for input from the console was generated by the diagnostic.</p> <p>Press RUN to return to the program — but it should be noted that the request is in error. The program should check for the presence of a console (address 114 = SC of the console) before making a request.</p>
106072*	<p>No diagnostic input device was specified during Manual or Automatic configuration. A pseudo-driver was configured in place of the diagnostic input device driver and a request for input was generated by the diagnostic or the operator.</p> <p>No loading is possible.</p>

HALT CODE	REASON/RESPONSE
106073*	This halt has two meanings as follows: <ol style="list-style-type: none">During a transfer using the I/O processor loader link, an error was encountered. Restart the loader program in the I/O processor.The diagnostic memory size exceeded the available space. (Refer to paragraph 2-10c.)
106074*	Error on diagnostic input device (paper tape, magnetic tape, cartridge tape, or disc): <ol style="list-style-type: none">Device not ready; ready device: Press RUN.Time-out on long paper tape leader: Press RUN.Incorrect SC or device type specified: Reconfigure Configurator.Data error on device: Restart loader in Configurator by setting P = 120, A-REG to DSN, and B-REG to serial execution.
106075*	All unused memory locations in the first 4K are loaded with halts 106075.
106076*	An output request to the line printer has been generated and the line printer was not ready. Ready the line printer and press RUN.
106077*	Trap cell halt. M-REG = trap cell address.

*These halts can occur during diagnostic execution.

OPERATOR'S NOTES

APPENDIX

C

C-1. GENERAL

Appendix C is divided into four basic sections:

1. Figure C-1 gives the operator the basic instructions to transfer the Configurator and diagnostic(s) and/or control programs from one medium to another. It is a general guide to lead the user to the appropriate area in this manual (in case of paper tape dump or disc initialization), or to an operating system.
2. Magnetic tape and cartridge tape format required by basic loader and loader in Configurator.
3. Cartridge Disc Initialization for HP 7900/7901, HP 7905 and HP 7920.
4. Cross Link for program down-loading from a second computer in a multicomputer system.

LOAD CONFIGURATOR, DIAGNOSTIC(S), AND/OR CONTROL PROGRAM(S) FROM:	IF IT IS DESIRED TO TRANSFER THE CONFIGURATOR, DIAGNOSTIC(S), AND/OR CONTROL PROGRAMS TO:		
	PAPER TAPE	7970 MAG TAPE (9-TRACK) OR 2644/45 CARTRIDGE TAPE	7900/01 DISC 7905 DISC
Paper tape	Use Paper Tape Dump routine in Configurator; load Configurator and diagnostic from paper tape and create a memory dump of: <ol style="list-style-type: none"> a. Configured Configurator. — or — b. Configured Configurator and unconfigured diagnostic. — or — c. Configured Configurator and configured diagnostic. 	Not possible with Configurator. Use DOS or RTE to transfer the absolute binary diagnostics onto magnetic tape or RTE to transfer the binary onto cartridge tape.	Use Disc Initialization Program to create a diagnostic disc with Configurator, desired diagnostic(s), and/or control program(s).
7970 Magnetic Tape (9-track) or 2644/45 Cartridge Tape.	Not possible with Configurator. Use DOS or RTE System for magnetic tape; use RTE System for cartridge tape.		
7900/01 Disc 7905 Disc 7920 Disc	Not possible due to special disc format.		

Figure C-1. Program Transfer Guide

C-2. MAGNETIC TAPE AND CARTRIDGE TAPE FORMAT

To facilitate the use of magnetic tape and cartridge tape, input drivers were added to the Configurator. This allows the operator to boot-in the Configurator, then load diagnostics using the Configurator driver. The Configurator, diagnostics, and control programs are in absolute binary format and the last file is followed by a second EOF record. To create a magnetic tape, the operator must use RTE or DOS to write the absolute binary programs onto magnetic tape. To create a cartridge tape, the operator must use RTE. Refer to figure C-2 for the format used on magnetic tape and cartridge tape.

C-3. CARTRIDGE DISC INITIALIZATION

C-4. GENERAL

The Cartridge Disc Initialization program is used to write first the Configurator, then Diagnostics and/or Control Programs on an HP 7900/1, HP 7905, or HP 7920 Cartridge Disc. After the Cartridge Disc has been initialized, the operator uses the Disc Loader (IBL or BMDL) to load the Configurator, then the Configurator is configured and used to load programs specified by a DSN from the disc.

The Disc Initialization program allows either the Configurator, diagnostics, and control programs to be coresident on a disc with an RTE or DOS operating system or have a disc entirely dedicated to diagnostic programs. When using the Disc Loader, the operator can specify via S-Register bit 3 to load either the Configurator (bit 3 set) or the system boot (bit 3 cleared), provided a system was on the disc prior to initialization. Disc Initialization requires continuous tracks on the disc. Track sparing is not employed by Disc Initialization. If diagnostics are coresident with a system, the system cannot do track sparing in the area where the diagnostic will be stored.

C-5. REQUIRED HARDWARE

The following hardware is required:

- a. An HP 2100 series computer with at least 4K of memory.
- b. An HP 7900/1, HP 7905, or HP 7920 Cartridge Disc. (Only computer type and cartridge disc type combinations specified by the appropriate hardware manuals are allowed to run Disc Initialization. The disc platter must be formatted and track sparing cannot be used. It cannot be the same physical disc as specified in paragraph C-5d.)

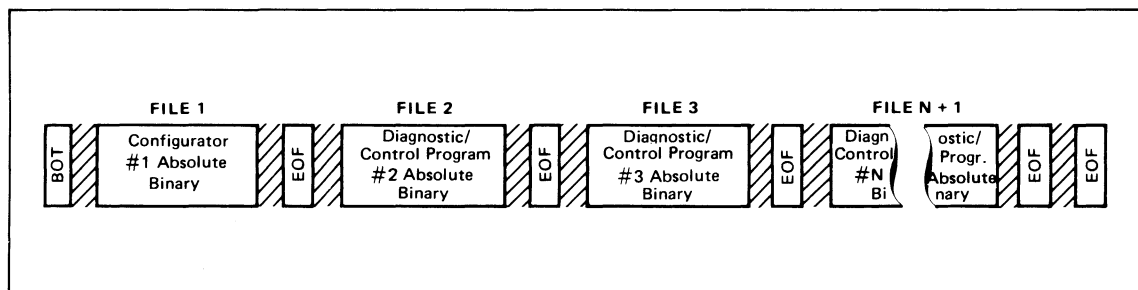

Figure C-2. Magnetic Tape and Cartridge Tape Format

- c. A console device for operator communication is required. The interface must be an HP 12531B/C/D, 12880A, 12587B, 12966A, or 12968A.
- d. A program input device as specified in paragraph 1-2d.

C-6. REQUIRED SOFTWARE

In addition to the Configurator and the programs to be loaded onto the disc, the Disc Initialization, part no. 24296-16002 is required.

C-7. OPERATING PROCEDURE

The operating procedures for Disc Initialization are outlined in figure C-3.

When the Disc Initialization program is executed it reads into memory cylinder 0, head 0, sector 0 where the system boot is located if the disc carries an operating system. It then copies data necessary for DOS IIIB, only that it saves the data so that the boot will operate with DOS IIIB.

After the Configurator has been loaded and configured, and the Disc Initialization has been loaded with the help of the Configurator, the program (when executed) writes a title message and asks the operator to input the disc device type and SC followed by the first and last cylinder number. The numbers entered are first checked to ensure that the first cylinder number is smaller than the second and that the second cylinder number is not greater than 202 for 7900/1 or 410 for 7905/20. If either of the above conditions exists, the question is repeated. The Configurator loader routine is then written on the disc in the first cylinder specified by the operator. If the boot on the disc is not the original system boot but a previous Configurator boot, the program reads the original system boot from its previous location. The system boot is then written on the disc in the same cylinder as the loading routine.

The operator is then asked for the input device to be used. When the device is ready, the routine copies all files from the input device to the disc. The files must contain records of 60 words or less and be in absolute binary format. The files are stored consecutively until all files have been copied from the input device. At this point the operator is asked "END OF FILES?". If more files are to be loaded from the same input device, the operator answers "NO". If the entire file loading process is completed, the disc is ready to be employed as a diagnostic input device and the operator answers "YES" to terminate the disc initialization. If "RUN" is pressed after halt 102077, the program will restart.

C-8. CARTRIDGE DISC FORMAT

The first cylinder specified by the operator contains the original system boot and the Configurator loading routine. These are memory image formats. The Configurator (which must be loaded first), diagnostics, and/or control programs start on the next sequential cylinder and are in absolute binary format with the exception of the first three words. Each file starts on a sector boundary and the first three words contain the following:

- a. Word 1 = the cylinder number of the next consecutive file.
- b. Word 2 = the head and the sector of the next consecutive file.
- c. Word 3 = the highest memory address location used by the file.

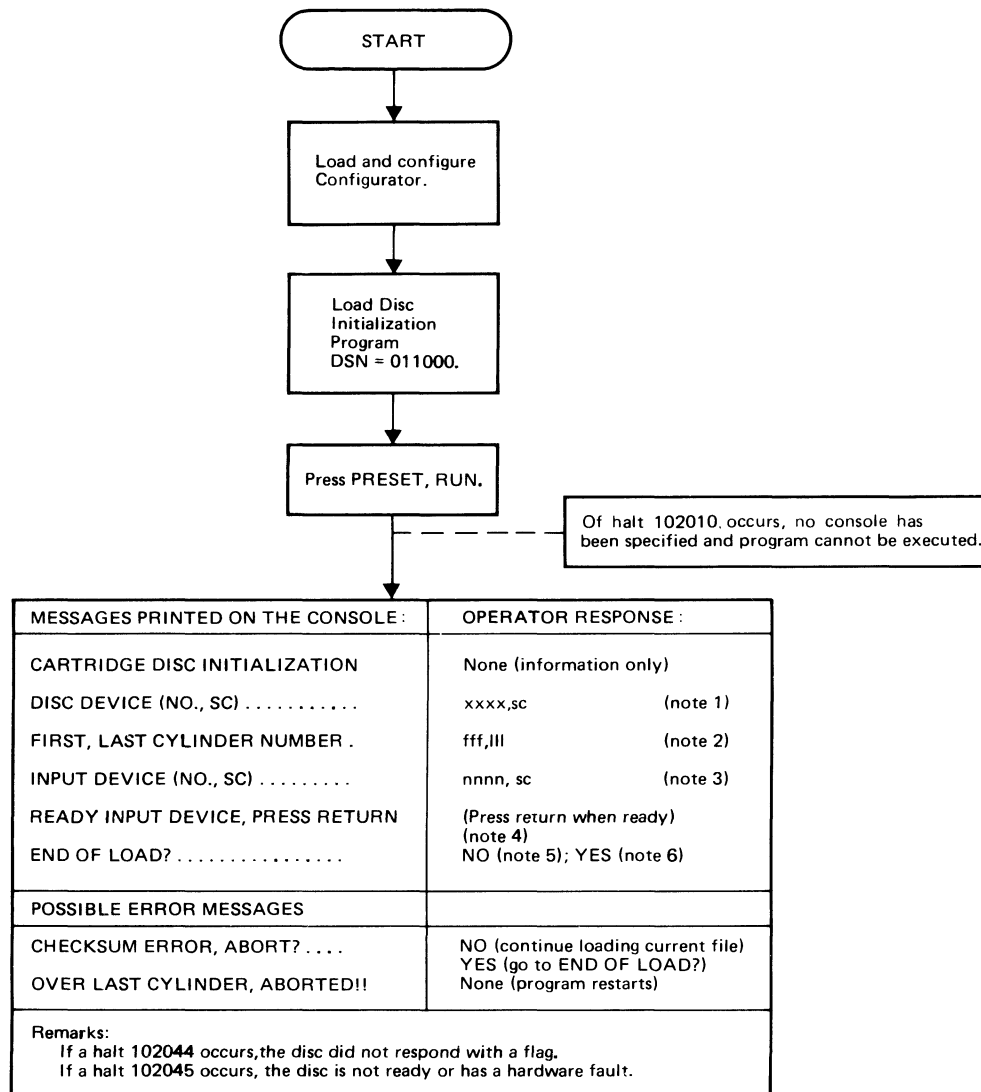

- NOTES:
1. Respond with appropriate disc model number and lower SC (higher priority). XXXX = 7900, 7901, or 7905.
 2. Respond with cylinder number on disc to be used for program storage.
 3. Respond with the appropriate device number (or two letters) and select code.

nnn	= 2737, 2748 or 2758	Paper tape devices
	= 7970	Mag tape (9 - track only, Unit 0 only)
	= 7900 or 7901	Cartridge disc (removable platter only)
	= 7905	Cartridge disc (removable platter, upper surface)
	= 7920	Cartridge disc (upper surface)
	= 2644 or 2645	Cartridge tape
SC	= select code of device	(Lower SC in case of 2 SC)
 4. All binary files will be transferred from specified input device to disc until double end of files or end of tape is reached. The Configurator must be first file loaded.
 5. Respond with "NO" to continue loading more files from specified input device after input device has been readied.
 6. Respond with "YES" if end of load operation.

Figure C-3. Disc Initialization Flowchart

The last file is an end of files mark where:

- a. Word 1 = all one's.
- b. Word 2 = all zero's.
- c. Word 3 = all zero's.

C-9. DISC INITIALIZATION EXAMPLE

The system configuration is used for the following Disc Initialization example:

- a. HP 21MX Computer with DMA, MPRT, and 32K memory.
- b. Console in select code 12.
- c. Paper tape reader in select code 13.
- d. HP 7900A Disc in select code 15.
- e. HP 7970B Magnetic Tape Unit in select code 21.

Initialize a cartridge disc using magnetic tape as a source for the binary files. The cartridge disc can:

- a. Be blank (but must be formatted),
- b. Have a system on it with a reserved area set aside when the system was generated, or
- c. Have a system on it with an area set aside in the file area on disc. This area, once initialized, cannot be moved (example PK command). Therefore, it should be the first area in the directory. The area can be set aside by the ST,B command for DOS or the CR command for RTE. (A directory list will give the starting cylinder of the file.)

After the Disc Initialization program has been loaded by the Configurator and started at location 100, the following messages appear on the terminal:

```
CARTRIDGE DISC INITIALIZATION
DISC DEVICE (NO.,SC) . . . . . 7900,15
FIRST, LAST CYLINDER NUMBERS.0,40    (blank disc or the area set aside)
INPUT DEVICE (NO.,SC) . . 7970,21
READY INPUT DEVICE, PRESS RETURN
```

At this point the program loads the binary files sequentially from magnetic tape. When the transfer is complete, the program will output the message "END OF LOAD?". If more files are to be loaded from the same device, answer "NO". If all files are loaded and the cartridge is ready, answer "YES".

C-10. CROSS LINK

C-11. GENERAL

Cross Link is used in a multicomputer environment where one computer is designated as a central processor and all others are I/O (slave) processors. It is used to load the Configurator,

diagnostics, and control programs from the central processor to an I/O processor through one of three possible links:

- a. HP 12875 Processor Interconnect. (Four 12566 interfaces; Cross Link utilizes one 12566 processor interconnect pair.)
- b. HP 12665 Computer Serial Interface Kit.
- c. HP 12773 Computer Modem Interface Kit.

The two interface kits have the same program control. The differences are that the 12665 is hardwired and the 12773 is modem connected.

The program is useful when the I/O processor has one of the two links to the central processor but no input device and/or no console and/or no line printer attached, and a diagnostic has to be loaded and executed in the I/O processor. This does not imply that all three peripheral devices have to be attached to the central processor. However, when any one of the three devices are attached to the central processor, Cross Link must be loaded and execution started in the central processor so that the linkage for that device can be established to the I/O processor.

All drivers (input device, console, and line printer) which have been loaded as part of the Configurator will be configured to the peripherals in the central processor. The Cross Link program, which then is loaded, will link the drivers via link routines from the central processor to the I/O processor. This feature gives the user the capability to load a program (diagnostic) from the input device via the input device link in the main processor through the input device coupler driver in the I/O processor into the I/O processor memory. Then he starts program execution in the I/O processor. Message reporting to the console is done via the console coupler driver in the I/O processor, the console link and console driver in the central processor, and to the attached console. See figure C-4.

The Cross Link program does require the full dedication of the central processor because it is a standalone program. It is not possible to initialize a disc through Cross Link.

C-12. REQUIRED HARDWARE

The following hardware is required:

- a. Two or more 2100 series computers, each with at least 4K of memory.
- b. HP 12875 Processor Interconnect or HP 12665/12773 Computer Serial Interface. (Only computer type and Processor Interconnect combinations or computer type and Serial Interface combinations specified by the appropriate hardware manuals are allowed.)
- c. A console device for operator communication is optional. See paragraph 1-2c.
- d. A program input device as specified in paragraph 1-2d.

C-13. REQUIRED SOFTWARE

In addition to the Configurator and the programs to be cross-loaded to the I/O processor, the Diagnostic Cross Link, part no. 24296-16003, is required.

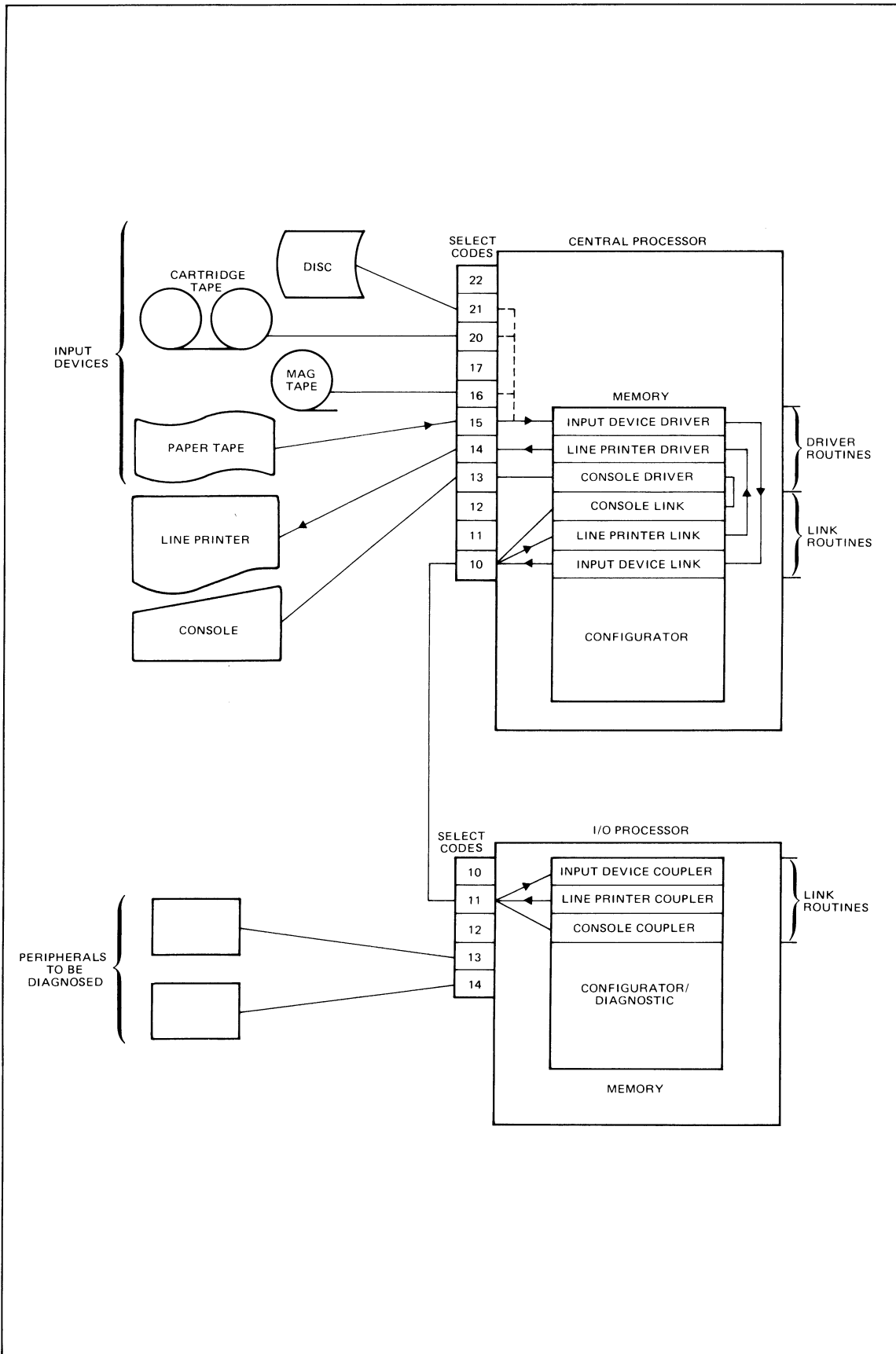
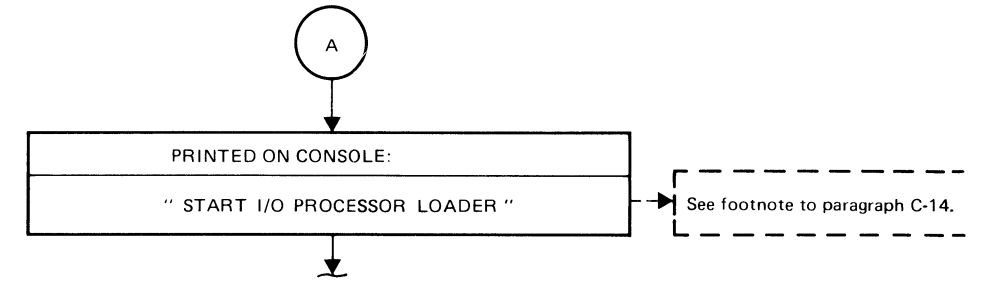
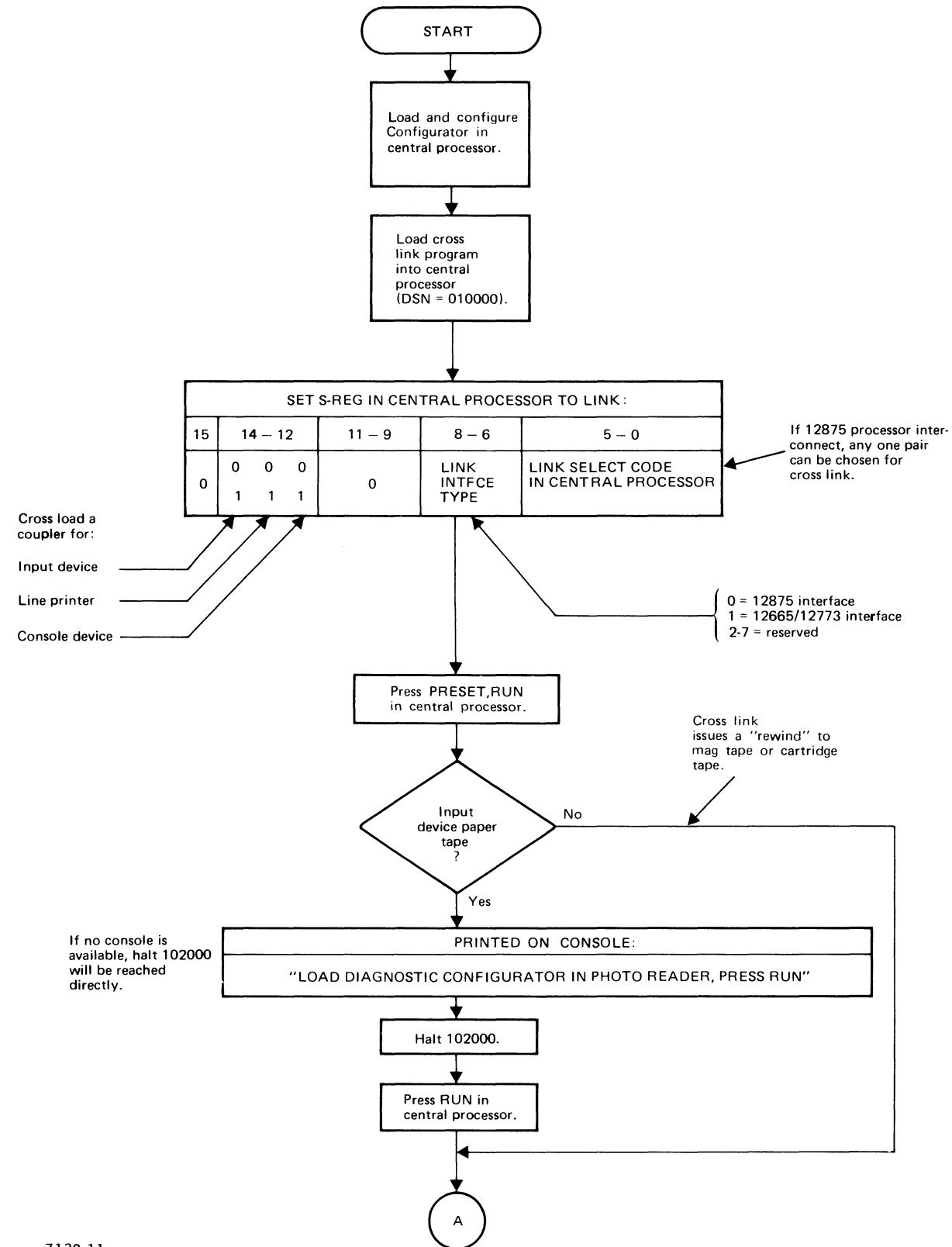

Figure C-4. Dual Computer Link

C-14. OPERATING PROCEDURES

The operating procedures for Cross Link are outlined in figure C-5. To execute the Cross Link program, the operator must first load and configure the Configurator in the central processor to the input device and/or console and/or line printer type and SC's, then load the Cross Link program with the Configurator. In S-Register bits 0-8, specify the link interface type and select codes and with S-Register bits 12-14, specify which drivers (input device, line printer, console) are to be used in the I/O processor. After pressing RUN on the central processor, the program instructs the operator to start the special binary loader* in the I/O processor to load the Configurator from the input device via the central processor to the I/O processor. When the Configurator is loaded, the Cross Link loads the couplers which were specified by the operator. It should be noted that the Cross Link program sets a flag in the I/O processor memory so that, when the Configurator in the I/O processor is configured, the program will use the console coupler (unless overridden by Manual Configuration). The input device coupler SC must be specified as the diagnostic input device during configuration of the Configurator. In case of a line printer, the first coupler SC must be specified.

*Special binary loader: for 12875 Processor Interconnect, standard Paper Tape Loader is employed to cross link.
for 12665/12773 Computer Interface Kit, SCE1 Loader Program, part no. 91700-16160 Rev. 1621, or equivalent ROM.



When I/O processor is started, the link program down loads the Configurator and then the selected couplers. (Note 1.)

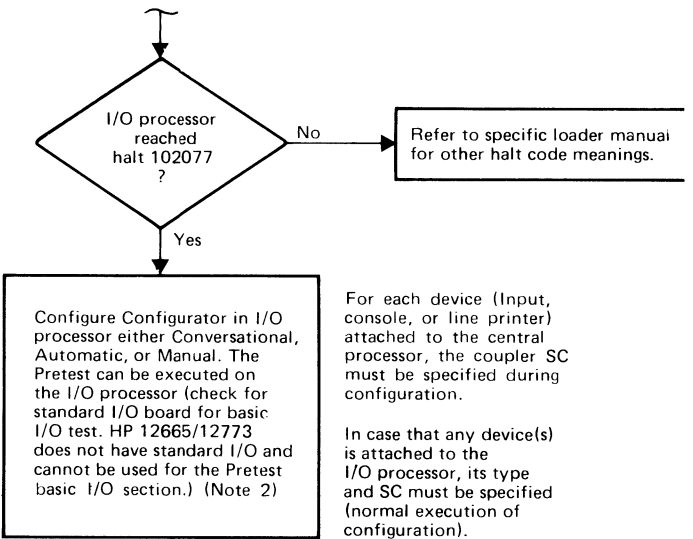

When the console SC is specified for Automatic or Conversational and a link has been cross loaded, the program will configure the link driver. This can be overridden by Manual configuration

- NOTES:
1. If an error occurs during cross loading, the program will output the message "CROSS LOAD ERROR (PRESS RUN TO START AGAIN)" and then halt 102060 is reached. When RUN is pressed, the program starts the Configurator loading process into the I/O processor again.
 2. If the link fails during configuration of the Configurator or executions of a diagnostic or control program, the program will output the message "CROSS LINK ERROR" and terminate the current operation and start checking for a new request.

PRETEST SOURCE LISTING

APPENDIX

D

PAGE 0002 #01 DIAGNOSTIC CONFIGURATOR (DSN 000200)

```

0001          ASMR,A,B,L,C
0003 00002          ORG 2
0004          SLP
0005 00000          A    EGL 2
0006 00001          B    EGL 1
0007 00000          SC   EGL 0
0008 00000          INTP EGL 2
0009 00001          SWREG EGL 1
0010 00002          DMA2  EGL 2
0011 00006          DMA6  EGL 6
0012 00005          MPRT  EGL 5
0013 00002 024130   JMP 130R      GC TO START OF PRETEST
0014 00003 106077   OCT 106077
0015          REP 15
0016 00004 106077   OCT 106077,106077,106077,106077
0016 00010 106077   OCT 106077,106077,106077,106077
0016 00014 106077   OCT 106077,106077,106077,106077
0016 00020 106077   OCT 106077,106077,106077,106077
0016 00024 106077   OCT 106077,106077,106077,106077
0016 00030 106077   OCT 106077,106077,106077,106077
0016 00034 106077   OCT 106077,106077,106077,106077
0016 00040 106077   OCT 106077,106077,106077,106077
0016 00044 106077   OCT 106077,106077,106077,106077
0016 00050 106077   OCT 106077,106077,106077,106077
0016 00054 106077   OCT 106077,106077,106077,106077
0016 00060 106077   OCT 106077,106077,106077,106077
0016 00064 106077   OCT 106077,106077,106077,106077
0016 00070 106077   OCT 106077,106077,106077,106077
0016 00074 106077   OCT 106077,106077,106077,106077
0017*
0018*          LINK TABLE
0019*
0020 00100 125417   START JMP CFGI,I      GC DIRECT TO CONFIGURATION
0021 00101 007431   CRI  DEF LCVR        DATA RECCRD INPUT
0022 00102 007327   COD  DEF CNSLO       CCNSOLE OUTPLT DRIVER
0023 00103 007404   LPD  DEF LNPTR       LINE PRINTER DRIVER
0024 00104 007354   CIO  DEF CNSLI       CCNSOLE INPUT DRIVER
0025 00105 000130   FWA  OCT 130         FIRST WORD OF AVBL. MEMORY
0026 00106 006477   LWA  DEF LWAA        LAST WORD OF AVBL. MEMORY
0027 00107 007167   CLP  DEF LCAD        DIAG. LOADER PROGRAM
0028 00110 177404   DEC  =252           1 MILSEC. TIME COUNT
0029 00111 000000   CRISC OCT 2         DATA RECCRD INPUT SELECT CCDE
0030 00112 000000   CODSC OCT 2         CCNSOLE OUTPUT SELECT CCDE
0031 00113 000000   LPDSC OCT 2         LINE PRINTER SELECT CCDE
0032 00114 000000   CIO SC OCT 2        CCNSOLE INPUT SELECT CCDE
0033 00115 000000   CTO  NCP             COMPUTER TYPE/OPTIONS
0034 00116 000000   NCP             USER CARD TYPE AND SELECT CCDE
0035 00117 000000   MEM  NCP             MEMORY SIZE
0036 00120 114107   JSR  DLP,I          GC TO DIAG. LOADER PROGRAM
0037 00121 006730   WAIT DEF TMR        1 MILL SEC TIMER ROUTINE
0038 00122 006722   SWRC DEF SWR        CHECK SWITCH REG
0039 00123 006610   C2AS DEF D2ASC       DECIMAL TO ASCII CONVERSION
0040 00124 006566   C2AS DEF C2ASC       CCTAL TO ASCII CONVERSION
0041 00125 006653   AS2N DEF ASC2N       ASCII TO BINARY CONVERSION
0042 00126 000200   DSN  OCT 000200     CCNF. SERIAL NUMBER
0043 00127 006502   FMTC DEF FMTR       FORMATTED OUTPUT

```

PAGE 0003 #01 DIAGNOSTIC CONFIGURATOR (CSN 000200)

0045* ONLY SINGLE OPERATION INSTRUCTIONS ARE TESTED.
 0046* IT IS ASSUMED THAT COMBINATIONS AFTER INITIAL
 0047* TEST WILL WORK (NOT NECESSARILY TRUE BUT NECESSARY).
 0048*
 0049* INSTRUCTIONS ARE TESTED IN THE FOLLOWING SEQUENCE:
 0050*
 0051* RSS SOS SCC STC CLO CLE SEZ CCE CME
 0052*
 0053* CLA CCA CPA SZA STA LDA INA CMA SSA SLA (B-REG INCLUSIVE)
 0054*
 0055* STA B,I STR A,I LDA B,I LDB A,I CPA B,I CPB A,I
 0056*
 0057* JMP (BP) JSB (BP) JSB (BP),I TC (BF)
 0058*
 0059* GENERAL MEMORY TEST (FIRST 4K ONLY)
 0060*
 0061* AND XOR ICR ISZ ADA ADB
 0062*
 0063* MEMORY ADDRESS, PATTERN & WORST CASE TEST (ABOVE 4K ONLY)
 0064*
 0065* CURRENT PAGE / BASE PAGE JMP LDA STA CPA JSB
 0066*
 0067* ALS ARS RAL RAR ALR ALF (BITS 8-6)
 0068*
 0069* ALS ARS RAL RAR ALR ALF (BITS 2-0)
 0070*
 0071* ELA ERA (BITS 8-6) ELA ERA (BITS 2-0)
 0072*
 0073*
 0074* ANY ERROR ENCOUNTERED WILL BE INDICATED BY
 0075* A HALT 66B (102066)
 0076* 00066 ERM EGU 66B
 0077* REFER TO LISTING AT THE M-REG. ADDRESS FOR DETAILS IF
 0078* A HALT OCCURS.
 0079* FOR REFERENCES (BP) = BASE PAGE AND (CP) = CURRENT PAGE

0081* ARITHMETIC SETTING OF E & C REGISTERS (INA ADA INB ADB)
 0082*
 0083* EXTEND & OVERFLOW REGISTER RESULTS
 0084*

AD*	MEM	TO REG.	=	REG.	CVF	EXT
0087*	+	+		+	0	0
0088*	+	+		-	1	0
0089*	+	-		+	0	1
0090*	-	+		+	0	1
0091*	-	+		-	0	0
0092*	+	-		-	0	0
0093*	-	-		-	0	1
0094*	-	-		+	1	1

PAGE 0004 #01 DIAGNOSTIC CONFIGURATOR (CSN 000200)

```

0096*          PRE-TEST PART A (BP)
0097*
0098 00130 107700          CLC INTP,C    GENERATE CRS
0099 00131 002001          RSS
0100 00132 102066  HLT  HLT ERH          RSS FAILED OR I/O CAUSED SKIP
0101*
0102 00133 071404          STA DISN      SAVE A=REG. FOR LATER
0103 00134 075405          STB DIBP      SAVE B=REG FOR LATER ALSO
0104 00135 002400          CLA
0105 00136 071406          STA SWRX      CLEAR S=REG. FLAG IF RESTART.
0106 00137 071407          STA BIOSC     CLEAR BASIC I/O SELECT CCCE
0107*
0108 00140 102101  PTLP  STC              START HERE IF PRE TEST LCCP
0109 00141 102201          SOC
0110 00142 102301          SCS
0111 00143 102066  HLT  HLT ERH          STC / SCC / SOS
0112 00144 103101          CLC
0113 00145 102301          SCS
0114 00146 102201          SOC
0115 00147 102066  HLT  HLT ERH          CLC / SOS / SCC
0116 00150 000040          CLE
0117 00151 002041          SEZ,RSS
0118 00152 002040          SEZ
0119 00153 102066  HLT  HLT ERH          CLE / SEZ,RSS / SEZ
0120 00154 002300          CCE
0121 00155 002040          SEZ
0122 00156 002041          SEZ,RSS
0123 00157 102066  HLT  HLT ERH          CCE / SEZ / SEZ,RSS
0124 00160 002200          CME
0125 00161 002041          SEZ,RSS
0126 00162 002040          SEZ
0127 00163 102066  HLT  HLT ERH          CME / SEZ / SEZ,RSS

```

PAGE 0005 #01 DIAGNOSTIC CONFIGURATOR (CSN 000200)

```

0129*
0130*
0131 00164 002400 CLA
0132 00165 007400 CCB
0133 00166 071376 STA TMPA
0134 00167 075377 STB TMPB
0135 00170 051335 CPA B0
0136 00171 002002 SZA
0137 00172 102066 HLT ERH CLA/CPA/SZA
0138 00173 006002 SZB
0139 00174 055335 CPB B0
0140 00175 102066 HLT ERH CCB/CPB/SZB
0141 00176 051366 CPA M1
0142 00177 102066 HLT ERH CPA
0143 00200 055335 CPB B0
0144 00201 102066 HLT ERH CPB
0145 00202 061377 LDA TMPB
0146 00203 065376 LCB TMPA
0147 00204 002002 SZA
0148 00205 051335 CPA B0
0149 00206 102066 HLT ERH STB/LDA
0150 00207 055335 CPB B0
0151 00210 006002 SZE
0152 00211 102066 HLT ERH STA/LCB
0153 00212 102301 SCS
0154 00213 002040 SEZ
0155 00214 102066 HLT ERH E / C SET
0156 00215 006004 INB
0157 00216 102301 SCS
0158 00217 002040 SEZ
0159 00220 102066 HLT ERH E / C SET
0160 00221 002004 INA
0161 00222 002040 SEZ
0162 00223 102201 SOC
0163 00224 102066 HLT ERH E NCT SET / C SET
0164 00225 000040 CLE
0165 00226 006002 SZB
0166 00227 002002 SZA
0167 00230 102066 HLT ERH INA/INE
0168 00231 055336 CPB B1
0169 00232 002001 RSS
0170 00233 102066 HLT ERH INB

```

PAGE 0006 #01 DIAGNOSTIC CONFIGURATOR (CSN 000200)

```

0172*
0173*
0174 00234 003400 CCA
0175 00235 006400 CLB
0176 00236 071376 STA TMPA
0177 00237 075377 STB TMPB
0178 00240 051366 CPA M1
0179 00241 002003 SZA,RSS
0180 00242 102066 HLT ERH CCA/CPA/SZA,RSS
0181 00243 006003 SZB,RSS
0182 00244 055366 CPB M1
0183 00245 102066 HLT ERH CLB/CPB/SZB,RSS
0184 00246 051335 CPA B0
0185 00247 102066 HLT ERH CPA
0186 00250 055366 CPB M1
0187 00251 102066 HLT ERH CPB
0188 00252 061377 LDA TMPB
0189 00253 065376 LDB TMPA
0190 00254 002003 SZA,RSS
0191 00255 051366 CPA M1
0192 00256 102066 HLT ERH STB/LDA
0193 00257 055366 CPB M1
0194 00260 006003 SZB,RSS
0195 00261 102066 HLT ERH STA/LDB
0196 00262 102301 SCS
0197 00263 002040 SEZ
0198 00264 102066 HLT ERH E / C SET
0199 00265 002004 INA
0200 00266 102301 SCS
0201 00267 002040 SEZ
0202 00270 102066 HLT ERH E / C SET
0203 00271 006004 INB
0204 00272 002040 SEZ
0205 00273 102201 SCC
0206 00274 102066 HLT ERH E NOT SET / C SET
0207 00275 000040 CLE
0208 00276 006003 SZB,RSS
0209 00277 002003 SZA,RSS
0210 00300 102066 HLT ERH INA/INB
0211 00301 051336 CPA B1
0212 00302 002001 RSS
0213 00303 102066 HLT ERH INA

```

PAGE 0007 #01 DIAGNOSTIC CONFIGURATOR (CSN 000200)

```

0215*
0216*
0217 00304 061413 LDA ALT0
0218 00305 065413 LCB ALT1
0219 00306 071376 STA TMPA
0220 00307 075377 STB TMPB
0221 00310 051413 CPA ALT0
0222 00311 002001 RSS
0223 00312 102066 HLT ERH LDA/CPA
0224 00313 055415 CPB ALT1
0225 00314 002001 RSS
0226 00315 102066 HLT ERH LDB/CPB
0227 00316 061377 LCA TMPB
0228 00317 065376 LCB TMPA
0229 00320 051415 CPA ALT1
0230 00321 002001 RSS
0231 00322 102066 HLT ERH LDA/STB
0232 00323 055413 CPB ALT0
0233 00324 002001 RSS
0234 00325 102066 HLT ERH LDB/STA
0235 00326 002004 INA
0236 00327 006004 INB
0237 00330 051416 CPA ALT1A
0238 00331 002001 RSS
0239 00332 102066 HLT ERH INA
0240 00333 055414 CPB ALT0A
0241 00334 002001 RSS
0242 00335 102066 HLT ERH INB

```

PAGE 0008 #01 DIAGNOSTIC CONFIGURATOR (DSN 200200)

		PRE-TEST PART A (BP)	
0244*			
0245*			
0246	00336 002400	CLA	
0247	00337 007400	CCB	
0248	00340 003000	CMA	
0249	00341 007000	CMB	
0250	00342 051366	CPA M1	
0251	00343 006002	SZB	
0252	00344 102066	HLT ERH	CMA / CMB
0253	00345 002020	SSA	
0254	00346 006020	SSB	
0255	00347 102066	HLT ERH	SSA / SSB
0256	00350 000010	SLA	
0257	00351 004010	SLB	
0258	00352 102066	HLT ERH	SLA / SLB
0259	00353 003000	CMA	
0260	00354 007000	CMB	
0261	00355 055366	CPB M1	
0262	00356 002002	SZA	
0263	00357 102066	HLT ERH	CMA / CMB
0264	00360 006020	SSB	
0265	00361 002020	SSA	
0266	00362 102066	HLT ERH	SSA / SSB
0267	00363 004010	SLB	
0268	00364 000010	SLA	
0269	00365 102066	HLT ERH	SLA / SLB
0270	00366 061413	LDA ALT0	
0271	00367 065415	LDB ALT1	
0272	00370 003000	CMA	
0273	00371 007000	CMB	
0274	00372 051415	CPA ALT1	
0275	00373 002001	RSS	
0276	00374 102066	HLT ERH	CMA
0277	00375 055413	CPB ALT0	
0278	00376 002001	RSS	
0279	00377 102066	HLT ERH	CMB

PAGE 0009 #01 DIAGNOSTIC CONFIGURATOR (DSN 000200)

```

0281*                PRE-TEST PART A (BF)
0282*
0283*                CHECK SWITCH REGISTER I/O
0284*
0285 00400 061406      LDA SWRX      CHECK IF SWREG HAS
0286 00401 002002      SZA                BEEN CHECK BEFORE
0287 00402 024452      JMP NXT00     YES SKIP CHECK
0288 00403 102501      LIA SWREG     GET AND
0289 00404 071406      STA SWRX      SAVE S-REG.
0290 00405 061413      LDA ALT0     TRY ALTERNATING PATTERNS
0291 00406 102601      OTA SWREG
0292 00407 102501      LIA SWREG
0293 00410 051406      CPA SWRX      STILL ORIGINAL?
0294 00411 061413      LDA ALT0     YES 2116/5 FORCE SKIP
0295 00412 051413      CPA ALT0
0296 00413 002001      RSS
0297 00414 102066      HLT ERH
0298 00415 061415      LDA ALT1     OTHER PATTERN
0299 00416 102601      OTA SWREG
0300 00417 102501      LIA SWREG
0301 00420 051406      CPA SWRX      STILL ORIGINAL?
0302 00421 061415      LDA ALT1     YES 2116/5 FORCE SKIP
0303 00422 051415      CPA ALT1
0304 00423 002001      RSS
0305 00424 102066      HLT ERH
0306 00425 003400      CCA                TRY OUTPLTING
0307 00426 102601      OTA SWREG     ALL ONE'S
0308 00427 102501      LIA SWREG     NOW GET IT BACK
0309 00430 051406      CPA SWRX      2115/2116?
0310 00431 024444      JMP **+11     OPERATOR MUST SET S-REG.
0311 00432 102501      LIA SWREG     GET IT AGAIN
0312 00433 051366      CPA M1        DID IT ECHO THE 1'S?
0313 00434 002001      RSS
0314 00435 102066      HLT ERH      NC
0315 00436 002400      CLA                TRY OUTPLTING
0316 00437 102601      OTA SWREG     B0 IS
0317 00440 102501      LIA SWREG     GET IT BACK
0318 00441 002002      SZA                OK
0319 00442 102066      HLT ERH      NC
0320 00443 024452      JMP NXT00     YES
0321 00444 102020      HLT 20B      2115/2116 OPERATOR MUST SET S-REG.
0322 00445 102501      LIA SWREG     GET IT
0323 00446 051366      CPA M1        IS IT ALL ONES
0324 00447 002001      RSS
0325 00450 102066      HLT ERH      NC INFORM OPERATOR
0326 00451 102021      HLT 21B      OPERATOR MUST CLEAR S-REG.
0327 00452                NXT00 EQL *
0328 00452 102501      LIA SWREG     GET IT AGAIN
0329 00453 002002      SZA                DID IT ECHO THE 0'S
0330 00454 102066      HLT ERH      NC
0331 00455 102301      SCS
0332 00456 002040      SEZ
0333 00457 102066      HLT ERH      E 0 SET

```

PAGE 0010 #01 DIAGNOSTIC CONFIGURATOR (DSN 000200)

```

0335*          PRE-TEST PART A (BP)
0336*
0337 00460 061431      LDA DTMPB
0338 00461 065430      LDB DTMPA
0339 00462 170001      STA B,I
0340 00463 174000      STB A,I
0341 00464 051376      CPA TMPA
0342 00465 002001      RSS
0343 00466 102066      HLT ERH          STA B,I/STB A,I
0344 00467 055377      CPB TMPB
0345 00470 002001      RSS
0346 00471 102066      HLT ERH          STA B,I/STB A,I
0347 00472 160001      LDA B,I
0348 00473 164000      LDB A,I
0349 00474 051376      CPA TMPA
0350 00475 002001      RSS
0351 00476 102066      HLT ERH          LCA B,I
0352 00477 055377      CPB TMPB
0353 00500 002001      RSS
0354 00501 102066      HLT ERH          LCB A,I
0355 00502 160000      LDA A,I
0356 00503 164001      LDB B,I
0357 00504 150001      CPA B,I
0358 00505 002001      RSS
0359 00506 102066      HLT ERH          CPA B,I/LDA A,I
0360 00507 154000      CPB A,I
0361 00510 002001      RSS
0362 00511 102066      HLT ERH          CPB A,I/LDB B,I

```

PAGE 0011 #01 DIAGNOSTIC CONFIGURATOR (DSN 000200)

```

0364*          PRE-TEST PART A (BF)
0365*
0366  00512  024514          JMP  **2
0367  00513  102066          HLT  ERH          JMP  (BF)
0368  00514  024520          JMP  **4
0369  00515  102066          HLT  ERH          JMP  (BF)
0370  00516  024522          JMP  **4
0371  00517  102066          HLT  ERH          JMP  (BF)
0372  00520  024516          JMP  **2
0373  00521  102066          HLT  ERH          JMP  (BF)
0374*
0375  00522  002400          CLA
0376  00523  070531          STA  JB0
0377  00524  070544          STA  JB1
0378  00525  060132          LDA  HLT0
0379  00526  064132          LCB  FLT0
0380  00527  014531          JSB  **2
0381  00530  102066          JBR0 HLT  ERH          JSB  (BF)
0382  00531  000000          JB0  NCP
0383  00532  060531          LDA  **1
0384  00533  051434          CPA  DJBR0
0385  00534  002001          RSS
0386  00535  102066          HLT  ERH          JSB  (BF)  RETURN ADDRESS
0387  00536  060132          LDA  HLT0
0388  00537  114541          JSB  **2,I
0389  00540  102066          JBR1 HLT  ERH          JSB  (BF),I
0390  00541  000544          DEF  **3
0391  00542  102066          HLT  ERH          JSB  (BF),I
0392  00543  102066          HLT  ERH          JSB  (BF),I
0393  00544  000000          JB1  NCP
0394  00545  060544          LDA  **1
0395  00546  051435          CPA  DJBR1
0396  00547  002001          RSS
0397  00550  102066          HLT  ERH          JSB  (BF),I  RETURN ADDRESS

```

PAGE 0012 *01 DIAGNOSTIC CONFIGURATOR (DSN 000200)

```

0399*                PRE-TEST PART A (BF)
0400*
0401*    GENERAL MEMORY TEST
0402*    COVERS 4K MEMORY (2 TO 7677)
0403*    EXCEPT THIS ROUTINE
0404*
0405  00551          GMTS  EGL  *
0406  00551  006400          CLB          START WITH ADDRESS
0407  00552  006004          INB
0408  00553  006004          INE          TWC
0409  00554  160001    L00  LCA  E,I    GET CURRENT CONTENTS
0410  00555  150001          CPA  B,I    DID IT LOAD OK?
0411  00556  002001          RSS
0412  00557  102066          HLT  ERH    NO FAILED ON LOAD
0413  00560  071376          STA  TMPA   CK SAVE ORIGINAL CONTENTS
0414  00561  003400          CCA
0415  00562  170001          STA  B,I    PUT ALL M1  IN LOCATION
0416  00563  150001          CPA  B,I    DID IT STORE?
0417  00564  002001          RSS
0418  00565  102066          HLT  ERH    NO FAILED ON STORE
0419  00566  002400          CLA          PUT 0  IN LOCATION
0420  00567  170001          STA  B,I
0421  00570  150001          CPA  B,I    DID IT STORE?
0422  00571  002001          RSS
0423  00572  102066          HLT  ERH    NO FAILED ON STORE
0424  00573  061413          LCA  ALT0   PUT ALTERNATING PATTERN IN LOCATION
0425  00574  170001          STA  B,I
0426  00575  150001          CPA  B,I    DID IT STORE?
0427  00576  002001          RSS
0428  00577  102066          HLT  ERH    NO
0429  00600  061415          LCA  ALT1   TRY OPPOSITE PATTERN
0430  00601  170001          STA  B,I
0431  00602  150001          CPA  B,I    DID IT STORE?
0432  00603  002001          RSS
0433  00604  102066          HLT  ERH    NO
0434  00605  061376          LCA  TMPA   RESTORE ORIGINAL CONTENTS
0435  00606  170001          STA  B,I
0436  00607  150001          CPA  B,I    DID IT GC BACK?
0437  00610  002001          RSS
0438  00611  102066          HLT  ERH    NO
0439  00612  006004          INB          MOVE TO NEXT LOCATION
0440  00613  055432          CPE  GMTSA   GET TO THIS PROGRAM
0441  00614  065433          LCB  GMTEA   YES SKIP OVER THIS SECTION
0442  00615  055361          CPE  B7700  DONE THIS 4K?
0443  00616  002001          RSS
0444  00617  024554          JMP  L00   NO DO NEXT LOCATION
0445  00620          GMTE  EGL  *

```

PAGE 0013 #01 DIAGNOSTIC CONFIGURATOR (CSN 000200)

```

0447*          PRE-TEST PART A (BF)
0448*
0449  00620 003400      CCA
0450  00621 011335      AND BR
0451  00622 002002      SZA
0452  00623 102066      HLT ERH      AND
0453  00624 061413      LDA ALT0
0454  00625 011415      AND ALT1
0455  00626 002002      SZA
0456  00627 102066      HLT ERH      AND
0457  00630 061415      LDA ALT1
0458  00631 011413      AND ALT0
0459  00632 002002      SZA
0460  00633 102066      HLT ERH      AND
0461  00634 003400      CCA
0462  00635 011413      AND ALT0
0463  00636 051413      CPA ALT0
0464  00637 002001      RSS
0465  00640 102066      HLT ERH      AND
0466  00641 003400      CCA
0467  00642 011415      AND ALT1
0468  00643 051415      CPA ALT1
0469  00644 002001      RSS
0470  00645 102066      HLT ERH      AND
0471*
0472  00646 002400      CLA
0473  00647 021335      XCR BR
0474  00650 002002      SZA
0475  00651 102066      HLT ERH      XCR
0476  00652 021413      XCR ALT0
0477  00653 051413      CPA ALT0
0478  00654 002001      RSS
0479  00655 102066      HLT ERH      XCR
0480  00656 021415      XCR ALT1
0481  00657 051366      CPA M1
0482  00660 002001      RSS
0483  00661 102066      HLT ERH      XCR
0484  00662 021413      XCR ALT0
0485  00663 051415      CPA ALT1
0486  00664 002001      RSS
0487  00665 102066      HLT ERH      XCR
0488  00666 021415      XCR ALT1
0489  00667 002002      SZA
0490  00670 102066      HLT ERH      XCR
0491  00671 003400      CCA
0492  00672 021366      XCR P1
0493  00673 002002      SZA
0494  00674 102066      HLT ERH      XCR

```

PAGE 0014 #01 DIAGNOSTIC CONFIGURATOR (DSN 000200)

		PRE-TEST PART A (BP)		
0496*				
0497*				
0498	00675 002400	CLA		
0499	00676 031335	ICR B0		
0500	00677 002002	SZA		
0501	00700 102066	HLT ERH	ICR	
0502	00701 031413	ICR ALT0		
0503	00702 051413	CPA ALT0		
0504	00703 002001	RSS		
0505	00704 102066	HLT ERH	ICR	
0506	00705 031415	ICR ALT1		
0507	00706 051366	CPA M1		
0508	00707 002001	RSS		
0509	00710 102066	HLT ERH	ICR	
0510	00711 002400	CLA		
0511	00712 031415	ICR ALT1		
0512	00713 051415	CPA ALT1		
0513	00714 002001	RSS		
0514	00715 102066	HLT ERH	ICR	
0515	00716 031413	ICR ALT0		
0516	00717 051366	CPA M1		
0517	00720 002001	RSS		
0518	00721 102066	HLT ERH	ICR	

PAGE 0015 #01 DIAGNOSTIC CONFIGURATOR (CSN 000200)

```

0520*          PRE-TEST PART A (BP)
0521*
0522 00722 002400      CLA
0523 00723 006400      CLB
0524 00724 071376      STA TMPA
0525 00725 051365      L01 CPA #100K
0526 00726 002001      RSS
0527 00727 024734      JMP **5
0528 00730 102201      SCC
0529 00731 002040      SEZ
0530 00732 102066      HLT ERH      E SET / C NOT SET
0531 00733 103101      CLC
0532 00734 102301      SCS
0533 00735 002040      SEZ
0534 00736 102066      HLT ERH      E / C SET
0535 00737 002004      INA
0536 00740 002003      SZB,RSS
0537 00741 024756      JMP NXT01
0538 00742 006004      INB
0539 00743 006003      SZB,RSS
0540 00744 102066      HLT ERH      INA
0541 00745 035376      ISZ TMPA
0542 00746 002001      RSS
0543 00747 102066      HLT ERH      ISZ
0544 00750 051376      CPA TMPA
0545 00751 002001      RSS
0546 00752 102066      HLT ERH      ISZ / INA
0547 00753 054000      CPB A
0548 00754 024725      JMP L01
0549 00755 102066      HLT ERH      ISZ / INB
0550 00756 002040      NXT01 SEZ
0551 00757 102201      SCC
0552 00760 102066      HLT ERH      E NOT SET / C SET
0553 00761 000040      CLB
0554 00762 006004      INB
0555 00763 002040      SEZ
0556 00764 102201      SCC
0557 00765 102066      HLT ERH      E NOT SET / C SET
0558 00766 000040      CLB
0559 00767 006002      SZB
0560 00770 102066      HLT ERH      INB
0561 00771 035376      ISZ TMPA
0562 00772 102066      HLT ERH      ISZ
0563 00773 102301      SCS
0564 00774 002040      SEZ
0565 00775 102066      HLT ERH      E / C SET

```

PAGE 0016 #01 DIAGNOSTIC CONFIGURATOR (CSN 000200)

```

0567*          PRE-TEST PART A (BP)
0566*
0569 00776 002400      CLA
0570 00777 007400      CCB
0571 01000 041336      ADA B1
0572 01001 102301      SCS
0573 01002 002040      SEZ
0574 01003 102066      HLT ERH      E / C SET
0575 01004 045336      ADB B1
0001 01005 002040      SEZ
0002 01006 102201      SCC
0003 01007 102066      HLT ERH      E NOT SET / C SET
0004 01010 000040      CLE
0005 01011 051336      CPA B1
0006 01012 006002      SZB
0007 01013 102066      HLT ERH      ADA/ADE
0008 01014 003400      CCA
0009 01015 006400      CLB
0010 01016 045336      ADB B1
0011 01017 102301      SCS
0012 01020 002040      SEZ
0013 01021 102066      HLT ERH      E / C SET
0014 01022 041336      ADA B1
0015 01023 002040      SEZ
0016 01024 102201      SCC
0017 01025 102066      HLT ERH      E NOT SET / C SET
0018 01026 000040      CLE
0019 01027 055336      CPE B1
0020 01030 002002      SZA
0021 01031 102066      HLT ERH      ADA/ADE
0022 01032 002400      CLA
0023 01033 007400      CCB
0024 01034 041366      ADA M1
0025 01035 102301      SCS
0026 01036 002040      SEZ
0027 01037 102066      HLT ERH      E / C SET
0028 01040 045366      ADB M1
0029 01041 002040      SEZ
0030 01042 102201      SCC
0031 01043 102066      HLT ERH      E NOT SET / C SET
0032 01044 000040      CLE
0033 01045 051366      CPA M1
0034 01046 002001      RSS
0035 01047 102066      HLT ERH      ADA
0036 01050 055367      CPB M2
0037 01051 002001      RSS
0038 01052 102066      HLT ERH      ADE
0039 01053 003400      CCA
0040 01054 006400      CLB
0041 01055 045366      ADB M1
0042 01056 102301      SCS
0043 01057 002040      SEZ
0044 01060 102066      HLT ERH      E / C SET
0045 01061 041366      ADA M1
0046 01062 002040      SEZ
0047 01063 102201      SCC

```

PAGE 0017 #02 DIAGNOSTIC CONFIGURATOR (CSN 000200)

0048	01064	102066	HLT ERH	E NOT SET / C SET
0049	01065	000040	CLE	
0050	01066	051367	CPA M2	
0051	01067	002001	RSS	
0052	01070	102066	HLT ERH	ADA
0053	01071	055366	CPB M1	
0054	01072	002001	RSS	
0055	01073	102066	HLT ERH	ADB
0056	01074	061413	LDA ALT0	
0057	01075	065415	LCB ALT1	
0058	01076	045415	ADB ALT1	
0059	01077	102201	SOC	
0060	01100	002040	SEZ	
0061	01101	102066	HLT ERH	E SET / C NOT SET
0062	01102	103101	CLO	
0063	01103	041416	ADA ALT1A	
0064	01104	002040	SEZ	
0065	01105	102201	SCC	
0066	01106	102066	HLT ERH	E NOT SET / C SET
0067	01107	000040	CLE	
0068	01110	055413	CPB ALT0	
0069	01111	002002	SZA	
0070	01112	102066	HLT ERH	ADA/ADB
0071	01113	061415	LDA ALT1	
0072	01114	065413	LCB ALT0	
0073	01115	041413	ACA ALT0	
0074	01116	102301	SCS	
0075	01117	002040	SEZ	
0076	01120	102066	HLT ERH	E / C SET
0077	01121	045416	ACB ALT1A	
0078	01122	002040	SEZ	
0079	01123	102201	SCC	
0080	01124	102066	HLT ERH	E NOT SET / C SET
0081	01125	000040	CLE	
0082	01126	051366	CPA M1	
0083	01127	006002	SZE	
0084	01130	102066	HLT ERH	ACA/ADB

PAGE 0018 #02 DIAGNOSTIC CONFIGURATOR (CSN 002200)

```

0086*                PRE-TEST PART A (BP)
0087*
0088*      *    CALCULATE MEMORY SIZE & RUN MEMCRY ADDRESS AND PATTERN CN
0089*                MEMORY ABOVE 4K-IF MEMCRY>4K.
0090*
0091 01131 065363      LDB B10K      START WITH 8K
0092 01132 045340      ADB B3        MOVE TO ADDRESS 3
0093 01133 002400      L02  CLA        CLEAR WRAPAROUND
0094 01134 070003      STA JB
0095 01135 061413      LCA ALTP      TRY TO
0096 01136 170001      STA B,I      WRITE PATTERN THERE
0097 01137 050003      CPA JE        DID IT WRAPAROUND
0098 01140 025152      JMP NXT02     YES = NO MEMCRY
0099 01141 150001      CPA B,I      DID THE PATTERN STORE?
0100 01142 025147      JMP **+5     YES, MEMORY IS THERE
0101 01143 002400      CLA        NO, SPOLLD
0102 01144 150001      CPA B,I      BE ALL
0103 01145 025152      JMP NXT02     0'S
0104 01146 102066      HLT ERH     NOT 0. SOMETHING'S WRONG
0105 01147 045363      ADB B10K    MOVE UP 4K
0106 01150 006021      SSB,RSS    DONE 32K?
0107 01151 025133      JMP L02     NO
0108 01152 060001      NXT02 LDA B  CHANGE HANDS
0109 01153 041370      ADA M10K   BACK UP ONE STEP
0110 01154 000040      CLE
0111 01155 103101      CLC
0112 01156 051340      CPA B3     ONLY 4K?
0113 01157 025771      JMP NXT05  YES = SKIP MEMORY TESTS
0114 01160 011364      AND B70K   ELIMINATE LOWER 2 BITS
0115 01161 041361      ADA B7700 POINT TO BINARY LOADER
0116 01162 041366      ACA M1
0117 01163 102601      OTA SWREG DISPLAY MEMORY SIZE
0118 01164 002040      SEZ
0119 01165 102201      SCC
0120 01166 102066      HLT ERH   E NOT SET / 0 SET
0121 01167 000040      CLE
0122 01170 071403      STA LADD   LWAP
0123 01171 061361      LDA B7700 SET FWAM
0124 01172 071402      STA FADD

```

PAGE 0019 #02 DIAGNOSTIC CONFIGURATOR (CSN 000200)

```

0126*      *   QUICK MEMORY ADDRESS TEST
0127*
0128 01173 061402      LDA FADD
0129 01174 170000      L03 STA A,I      STORE IN EACH
0130 01175 051403      CPA LADD      LOCATION OF AVAILABLE
0131 01176 025201      JMP **3      MEMORY THE ADDRESS
0132 01177 002004      INA      OF THAT LOCATION
0133 01200 025174      JMP L03
0134 01201 061402      LDA FADD
0135 01202 150000      L04 CPA A,I      VERIFY MEMORY
0136 01203 002001      RSS      CONTENTS
0137 01204 102066      HLT ERH      MEMORY ADDRESS FAILURE
0138 01205 051403      CPA LADD
0139 01206 025211      JMP **3      GO ON TO MEMORY PATTERN TEST
0140 01207 002004      INA
0141 01210 025202      JMP L04
0142*
0143*      *   QUICK MEMORY PATTERN TEST
0144*
0145 01211 003400      CCA      START WITH 177777
0146 01212 065402      L05 LDB FADD
0147 01213 170001      L06 STA B,I      WRITE PATTERN
0148 01214 006004      INB      IN A REG IN
0149 01215 055403      CPB LADD      AVAILABLE MEMRCY
0150 01216 002001      RSS
0151 01217 025213      JMP L06
0152 01220 065402      LDB FADD
0153 01221 150001      L07 CPA B,I      COMPARE PATTERN READ
0154 01222 002001      RSS      IC PATTERN WRITTEN
0155 01223 102066      HLT ERH      MEMORY PATTERN FAILED
0156 01224 006004      INB
0157 01225 055403      CPB LADD
0158 01226 002001      RSS
0159 01227 025221      JMP L07
0160 01230 051415      CPA ALT1      DONE 125252 YET?
0161 01231 025241      JMP NXT03      YES
0162 01232 051413      CPA ALT0
0163 01233 061415      LDA ALT1
0164 01234 002003      SZA,RSS
0165 01235 061413      LDA ALT0
0166 01236 051366      CPA M1
0167 01237 002400      CLA
0168 01240 025212      JMP L05
0169 01241      NXT03 EGL *

```

PAGE 0020 #02 DIAGNOSTIC CONFIGURATOR (DSN 000200)

```

0171*                               PRE-TEST PART A (BF)
0172*
0173*      WORST CASE PATTERN TEST
0174*
0175  01241 061402          LDA FADD
0176  01242 065402          LDB FADD
0177  01243 071376      L08  STA TMPA
0178  01244 011355          AND B140      WRITE
0179  01245 051355          CPA B140      WORST
0180  01246 002400          CLA          CASE
0181  01247 002002          SZA          PATTERN
0182  01250 003400          CCA
0183  01251 170001          STA B,I      IN MEMORY
0184  01252 055403          CPB LADD
0185  01253 025260          JMP NXT04
0186  01254 006004          INB
0187  01255 061376          LDA TMPA
0188  01256 002004          INA
0189  01257 025243          JMP L08
0190  01260 061402      NXT04 LDA FADD
0191  01261 065402          LDB FADD
0192  01262 071376      L09  STA TMPA
0193  01263 011355          AND B140      NOW
0194  01264 051355          CPA B140      COMPARE
0195  01265 002400          CLA          PATTERN
0196  01266 002002          SZA
0197  01267 003400          CCA
0198  01270 150001          CPA B,I
0199  01271 002001          RSS
0200  01272 102066          HLT ERH      MEMORY PATTERN FAILED
0201  01273 055403          CPB LADD
0202  01274 025771          JMP NXT05      CONTINUE
0203  01275 061444          LDA MHLT      FILL UNUSED MEMORY
0204  01276 170001          STA B,I      WITH HALTS
0205  01277 006004          INB
0206  01300 061376          LDA TMPA
0207  01301 002004          INA
0208  01302 025262          JMP L09

```

PAGE 0021 #02 DIAGNOSTIC CONFIGURATOR (DSN 000200)

```

0210*                PRE-TEST PART A (BP)
0211*
0212*                PROGRAM COMES HERE FROM CURRENT PAGE
0213*
0214*
0215  01303 125305 BPJP0 JMP **2,I
0216  01304 102066        HLT ERH        JMP (BP),I (TO BP)
0217  01305 001310        DEF **3
0218  01306 102066        HLT ERH        JMP (BP),I (TO BP)
0219  01307 102066        HLT ERH        "          "
0220  01310 125312        JMP **2,I
0221  01311 102066        HLT ERH        JMP (BP),I (TO CP)
0222  01312 002037        DEF CPJP0
0223  01313 102066        HLT ERH        JMP (BP),I (TO CP)
0224  01314 102066        HLT ERH        "          "
0225  01315 125317 BPJP1 JMP **2,I
0226  01316 102066        HLT ERH        JMP (BP),I (TO CP)
0227  01317 002044        DEF CPJP1
0228  01320 102066        HLT ERH        JMP (BP),I (TO CP)
0229  01321 102066        HLT ERH        "          "
0230*
0231  01322 000000 BPJB0 NCP
0232  01323 061322        LDA **1
0233  01324 051436        CPA DJBR2
0234  01325 002001        RSS
0235  01326 102066        HLT ERH        JSB (BP) FROM CP RETURN ADDRESS
0236  01327 060132        LDA FLT0
0237  01330 115332        JSB **2,I
0238  01331 102066        JBR5  HLT ERH        JSB (BP),I TO CP
0239  01332 002105        DEF CPJB0
0240  01333 102066        HLT ERH        JSB (BP),I TO CP
0241  01334 102066        HLT ERH        JSB (BP),I TO CP
0242*
0243*                END OF PRE-TEST PART A (BP)

```

PAGE 0022 #02 DIAGNOSTIC CONFIGURATOR (CSN 000200)

```

0245*      *   STORAGE AND CONSTANTS
0246*
0247  01335 000000 B0   OCT 0
0248  01336 000001 B1   OCT 1
0249  01337 000002 B2   OCT 2
0250  01340 000003 B3   OCT 3
0251  01341 000004 B4   OCT 4
0252  01342 000005 B5   OCT 5
0253  01343 000006 B6   OCT 6
0254  01344 000007 B7   OCT 7
0255  01345 000010 B10  OCT 10
0256  01346 000017 B17  OCT 17
0257  01347 000037 B37  OCT 37
0258  01350 000040 B40  OCT 40
0259  01351 000054 B54  OCT 54
0260  01352 000060 B60  OCT 60
0261  01353 000070 B70  OCT 70
0262  01354 000077 B77  OCT 77
0263  01355 000140 B140 OCT 140
0264  01356 000170 B170 OCT 170
0265  01357 000177 B177 OCT 177
0266  01360 000777 B777 OCT 777
0267  01361 007700 B7700 OCT 7700
0268  01362 006500 B6.5K OCT 6500
0269  01363 010000 B10K  OCT 10000
0270  01364 070000 B70K  OCT 70000
0271  01365 100000 B100K OCT 100000
0272  01366 177777 M1   OCT -1
0273  01367 177776 M2   OCT -2
0274  01370 170000 M10K OCT -10000
0275  01371 177760 M17  OCT 177760
0276  01372 177700 M77  OCT 177700
0277  01373 107777 M70K OCT 107777
0278  01374 010003 D0K3 OCT 10003
0279  01375 070003 D32K3 OCT 70003
0280  01376 177777 TMPA OCT -1
0281  01377 000000 TMPB OCT 0
0282  01400 000000 SVA  NCP
0283  01401 000000 SVB  NCP
0284  01402 000000 FADD NCP
0285  01403 000000 LADD NCP
0286  01404 000000 DISK NCP
0287  01405 000000 DIOP NCP
0288  01406 000000 SWRX NCP
0289  01407 000000 B10SC NCP
0290  01410 000000 SCX  NCP
0291  01411 000000 IBUF NCP
0292  01412 172525 APTRN OCT 172525
0293  01413 125252 ALT0 OCT 125252
0294  01414 125253 ALT0A OCT 125253
0295  01415 052525 ALT1 OCT 052525
0296  01416 052526 ALT1A OCT 052526

```

PAGE 0023 #02 DIAGNOSTIC CONFIGURATOR (CSN 000200)

```

0298 01417 002720 CFGI DEF CFRG
0299 01420 004100 CFSB DEF CKSC
0300 01421 004062 ISCR DEF ISC
0301 01422 004024 MDVR DEF MVDVR
0302 01423 004000 CFM DEF CFMEM
0303 01424 004113 MSG DEF MSGR
0304 01425 004150 IBUF DEF IBUF
0305 01426 004163 CNST DEF CNTS
0306 01427 004261 CNSC DEF CVSC
0307 01430 001376 DTMPA DEF TMPA
0308 01431 001377 DTMPB DEF TMPB
0309 01432 000551 GMTSA DEF GMTS
0310 01433 000620 GMTSA DEF GMTS
0311 01434 000530 CJBR0 DEF JBR0
0312 01435 000540 CJBR1 DEF JBR1
0313 01436 002104 CJBR2 DEF JBR2
0314 01437 006740 DTMC DEF TMC
0315 01440 006734 DTMI DEF TMI
0316 01441 007431 LCDVR DEF LCDVR
0317 01442 007327 CCO DEF CNSLO
0318 01443 007404 LPDV DEF LMPTR
0319 01444 106075 MFLT OCT 106075
0320*
0321*
0322 01445 015446 CFMPJ JSB **1
0323 01446 000000 NCP
0324 01447 103100 CLF INTP
0325 01450 107705 CLC 5B,C TURN OFF MEMORY PROTECT
0326 01451 006400 CLB
0327 01452 125446 JMP **4,I RETURN
0328*
0329 01453 101454 CEFT DEF **1,I
0330 01454 000101 OCT 101,102,103,104,106,107
0331 01462 000121 OCT 121,122,123,124,125,127
0332 01470 001437 DEF DTMC
0333 01471 006501 DEF LCMXA
0334 01472 006562 DEF FMTBF
0335 01473 001366 DEF M1
0336*
0337 01474 160000 CMABT OCT 160000

```

PAGE 0028 #02 DIAGNOSTIC CONFIGURATOR (DSN 000200)

```

0484*          START OF PRE-TEST PART B (CP)
0485*
0486 01771 002400  NXT05 CLA
0487 01772 102601      OTA SWREG      CLEAR S-REG.
0488 01773 102301      SOS
0489 01774 002040      SEZ
0490 01775 102066      HLT ERH      E / C SET
0491 01776 060132      LDA HLT0      HALT IF CURRENT PAGE/
0492 01777 064132      LDB HLT0      BASE PAGE DOESN'T WORK
0493 02000 026001      JMP **+1
0494 02001 066764      LDE .ALT1
0495 02002 061413      LDA ALT0
0496 02003 002001      RSS
0497 02004 000001      OCT 1      USED IN CPU TYPE CALCULATION
0498 02005 072771      STA .TMPA
0499 02006 075377      STB TMPB
0500 02007 052763      CPA .ALT0
0501 02010 002001      RSS
0502 02011 102066      HLT ERH      LDA (BP) / CPA (CP)
0503 02012 055415      CPB ALT1
0504 02013 002001      RSS
0505 02014 102066      HLT ERH      LDB (CP) / CPB (BP)
0506 02015 066771      LDB .TMPA
0507 02016 061377      LDA TMPB
0508 02017 052764      CPA .ALT1
0509 02020 002001      RSS
0510 02021 102066      HLT ERH      STB (BP)   CPA (CP)
0511 02022 055413      CPB ALT0
0512 02023 002001      RSS
0513 02024 102066      HLT ERH      STA (CP) / CPB (BP)

```

PAGE 0029 #02 DIAGNOSTIC CONFIGURATOR (CSN 000200)

```

0515*                                PRE-TEST PART B (CF)
0516 02025 026027                    JMP **2
0517 02026 102066                    HLT ERH          JMP (CF)
0518 02027 026033                    JMP **4
0519 02030 102066                    HLT ERH          JMP (CF)
0520 02031 026035                    JMP **4
0521 02032 102066                    HLT ERH          JMP (CF)
0522 02033 026031                    JMP **2
0523 02034 102066                    HLT ERH          JMP (CF)
0524*
0525 02035 025303                    JMP BPJP0
0526 02036 102066                    HLT ERH          JMP (CF) TO (BP)
0527 02037 126041                    CPJP0 JMP **2,I
0528 02040 102066                    HLT ERH          JMP (CF),I (TO BP)
0529 02041 001315                    DEF BPJP1
0530 02042 102066                    HLT ERH          JMP (CF),I (TO BP)
0531 02043 102066                    HLT ERH          " " "
0532 02044 126046                    CPJP1 JMP **2,I
0533 02045 102066                    HLT ERH          JMP (CF),I (TO CP)
0534 02046 002051                    DEF **3
0535 02047 102066                    HLT ERH          JMP (CF),I (TO CP)
0536 02050 102066                    HLT ERH          " "
0537*
0538 02051 002400                    CLA
0539 02052 072062                    STA .JB0
0540 02053 072075                    STA .JB1
0541 02054 071322                    STA BPJB0
0542 02055 072105                    STA CFJB0
0543 02056 060132                    LDA HLT0
0544 02057 064132                    LCB HLT0
0545 02060 016062                    JSB **2
0546 02061 102066                    JBR3 HLT ERH          JSB (CF)
0547 02062 000000                    .JB0 NCP
0548 02063 062062                    LDA **1
0549 02064 052773                    CPA DJBR3
0550 02065 002001                    RSS
0551 02066 102066                    HLT ERH          JSB (CF) RETURN ADDRESS
0552 02067 060132                    LDA HLT0
0553 02070 116072                    JSB **2,I
0554 02071 102066                    JBR4 HLT ERH          JSB (CF),I
0555 02072 002075                    DEF **3
0556 02073 102066                    HLT ERH          JSB (CF),I
0557 02074 102066                    HLT ERH          JSB (CF),I
0558 02075 000000                    .JB1 NCP
0559 02076 062075                    LDA **1
0560 02077 052774                    CPA DJBR4
0561 02100 002001                    RSS
0562 02101 102066                    HLT ERH          JSB (CF),I RETURN ADDRESS
0563 02102 060132                    LDA HLT0
0564 02103 015322                    JSB BFJB0
0565 02104 102066                    JBR2 HLT ERH          JSB (BF)
0566 02105 000000                    CPJB0 NCP
0567 02106 062105                    LDA **1
0568 02107 052775                    CPA DJBR5
0569 02110 002001                    RSS
0570 02111 102066                    HLT ERH          JSB (BF),I TO CP RETURN ADDRESS

```

PAGE 0030 #02 DIAGNOSTIC CONFIGURATOR (DSN 000200)

```

0572*
0573*
0574 02112 062765 LDA SRGP1 1000100100100111
0575 02113 066766 LDB SRGP2 1001100000100000
0576 02114 001000 ALS 1001001001001110
0001 02115 005100 BRS 1100110000010000
0002 02116 001100 ARS 1100100100100111
0003 02117 005400 BLR 0001100000100000
0004 02120 001000 ALS 1001001001001110
0005 02121 005700 BLF 1000001000000001
0006 02122 001300 RAR 0100100100100111
0007 02123 005000 BLS 1000010000000010
0008 02124 001100 ARS 0010010010010011
0009 02125 005300 RBR 0100001000000001
0010 02126 001400 ALR 0100100100100110
0011 02127 005000 BLS 0000010000000010
0012 02130 001200 RAL 1001001001001100
0013 02131 005700 BLF 0100000000100000
0014 02132 001100 ARS 1100100100100110
0015 02133 005200 RBL 1000000000100000
0016 02134 001400 ALR 0001001001001100
0017 02135 005100 BRS 1100000000100000
0018 02136 001700 ALF 0010010011000001
0019 02137 005200 RBL 10000000001000001
0020 02140 001200 RAL 0100100110000010
0021 02141 005100 BRS 1100000000100000
0022 02142 001000 ALS 0001001100000100
0023 02143 005300 RBR 0110000000010000
0024 02144 001300 RAR 0000100110000010
0025 02145 005400 BLR 0100000000100000
0026 02146 001700 ALF 10011000000100000
0027 02147 005000 BLS 0000000000100000
0028 02150 052766 CPA SRGP2
0029 02151 002001 KSS
0030 02152 102066 HLT ERH SRG INST A=REG.
0031 02153 056767 CPE SRGP3
0032 02154 002001 RSS
0033 02155 102066 HLT ERH SRG INST B=REG.
0034 02156 102301 SCS
0035 02157 002040 SEZ
0036 02160 102066 HLT ERH E / O SET

```

PAGE 0031 #03 DIAGNOSTIC CONFIGURATOR (DSN 000200)

```

0038*
0039*
0040 02161 006765 LDB SRGP1 1000100100100111
0041 02162 002766 LDA SRGP2 1001100000100000
0042 02163 005000 BLS 1001001001001110
0043 02164 001100 ARS 1100110000010000
0044 02165 005100 BRS 1100100100100111
0045 02166 001400 ALR 0001100000100000
0046 02167 005000 BLS 1001001001001110
0047 02170 001700 ALF 1000001000000001
0048 02171 005300 RBF 0100100100100111
0049 02172 001000 ALS 1000010000000010
0050 02173 005100 BRS 0010010010010011
0051 02174 001300 RAR 0100001000000001
0052 02175 005400 BLR 0100100100100110
0053 02176 001000 ALS 0000010000000010
0054 02177 005200 RBL 1001001001001100
0055 02200 001700 ALF 0100000000100000
0056 02201 005100 BRS 1100100100100110
0057 02202 001200 RAL 1000000000100000
0058 02203 005400 BLF 0001001001001100
0059 02204 001100 ARS 1100000000100000
0060 02205 005700 BLF 0010010011000001
0061 02206 001200 RAL 1000000000100000
0062 02207 005200 RBL 0100100110000010
0063 02210 001100 ARS 1100000000100000
0064 02211 005000 BLS 0001001100000100
0065 02212 001300 RAK 0110000000010000
0066 02213 005300 RBF 0000100110000010
0067 02214 001400 ALR 0100000000100000
0068 02215 005700 BLF 1001100000100000
0069 02216 001000 ALS 0000000000100000
0070 02217 006766 CPB SRGP2
0071 02220 002001 HSS
0072 02221 102066 HLT ERH SRG INST B-REG.
0073 02222 002767 CPA SRGP3
0074 02223 002001 HSS
0075 02224 102066 HLT ERH SRG INST A-REG.
0076 02225 102301 SCS
0077 02226 002040 SEZ
0078 02227 102066 HLT ERH E / C SET

```

```

0080*
0081*
0082 02230 062765 LDA SRGP1 1000100100100111
0083 02231 066766 LCB SRGP2 1001100000100000
0084 02232 000020 OCT 0020 ALS 1001001001001110
0085 02233 004021 OCT 4021 BRS 1100110000010000
0086 02234 000021 OCT 0021 ARS 1100100100100111
0087 02235 004024 OCT 4024 BLR 0001100000100000
0088 02236 000020 OCT 0020 ALS 1001001001001110
0089 02237 004027 OCT 4027 BLF 1000001000000001
0090 02240 000023 OCT 0023 RAR 0100100100100111
0091 02241 004020 OCT 4020 BLS 1000010000000100
0092 02242 000021 OCT 0021 ARS 0010010010010011
0093 02243 004023 OCT 4023 RBR 0100001000000001
0094 02244 000024 OCT 0024 ALR 0100100100100110
0095 02245 004020 OCT 4020 BLS 0000010000000010
0096 02246 000022 OCT 0022 RAL 1001001001001100
0097 02247 004027 OCT 4027 BLF 0100000000100000
0098 02250 000021 OCT 0021 ARS 1100100100100110
0099 02251 004022 OCT 4022 RBL 1000000000100000
0100 02252 000024 OCT 0024 ALR 0001001001001100
0101 02253 004021 OCT 4021 BRS 1100000000100000
0102 02254 000027 OCT 0027 ALF 0010010011000001
0103 02255 004022 OCT 4022 RBL 1000000000100000
0104 02256 000022 OCT 0022 RAL 0100100110000010
0105 02257 004021 OCT 4021 BRS 1100000000100000
0106 02260 000020 OCT 0020 ALS 0001001100000100
0107 02261 004023 OCT 4023 RBR 0110000000010000
0108 02262 000023 OCT 0023 RAR 0000100110000010
0109 02263 004024 OCT 4024 BLR 0100000000100000
0110 02264 000027 OCT 0027 ALF 1001100000100000
0111 02265 004020 OCT 4020 BLS 0000000001000000
0112 02266 052766 CPA SRGP2
0113 02267 002001 RSS
0114 02270 102066 HLT ERH SRG INST A-REG.
0115 02271 056767 CPE SRGP3
0116 02272 002001 RSS
0117 02273 102066 HLT ERH SRG INST B-REG.
0118 02274 102301 SCS
0119 02275 002040 SEZ
0120 02276 102066 HLT ERH E / C SET
    
```

PAGE 0033 #03 DIAGNOSTIC CONFIGURATOR (DSN 000200)

```

0122*                                PRE-TEST PART B (CF)
0123*
0124 02277 066765                    LCB SRGP1      1000100100100111
0125 02300 062766                    LCA SRGP2                                1001100000100000
0126 02301 004020                    OCT 4020 BLS  1001001001001110
0127 02302 000021                    OCT 0021 ARS  1100110000010000
0128 02303 004021                    OCT 4021 BRS  1100100100100111
0129 02304 000024                    OCT 0024 ALR  0001100000100000
0130 02305 004020                    OCT 4020 BLS  1001001001001110
0131 02306 000027                    OCT 0027 ALF  1000001000000001
0132 02307 004023                    OCT 4023 RBR  0100100100100111
0133 02310 000020                    OCT 0020 ALS  1000010000000010
0134 02311 004021                    OCT 4021 BRS  00100010010010011
0135 02312 000023                    OCT 0023 RAR  0100001000000001
0136 02313 004024                    OCT 4024 BLR  0100100100100110
0137 02314 000020                    OCT 0020 ALS  0000010000000010
0138 02315 004022                    OCT 4022 RBL  1001001001001100
0139 02316 000027                    OCT 0027 ALF  0100000000100000
0140 02317 004021                    OCT 4021 BRS  1100100100100110
0141 02320 000022                    OCT 0022 RAL  1000000000100000
0142 02321 004024                    OCT 4024 BLR  0001001001001100
0143 02322 000021                    OCT 0021 ARS  1100000000100000
0144 02323 004027                    OCT 4027 BLF  0010010011000001
0145 02324 000022                    OCT 0022 RAL  1000000000100000
0146 02325 004022                    OCT 4022 RBL  0100100110000010
0147 02326 000021                    OCT 0021 ARS  1100000000100000
0148 02327 004020                    OCT 4020 BLS  0001001100000100
0149 02330 000023                    OCT 0023 RAR  0110000000010000
0150 02331 004023                    OCT 4023 RBR  0000100110000010
0151 02332 000024                    OCT 0024 ALR  0100000000100000
0152 02333 004027                    OCT 4027 BLF  1001100000100000
0153 02334 000020                    OCT 0020 ALS  0000000001000000
0154 02335 056766                    CPE SRGP2
0155 02336 002001                    RSS
0156 02337 102066                    HLT ERH      SRG INST B-REG.
0157 02340 052767                    CPA SRGP3
0158 02341 002001                    RSS
0159 02342 102066                    HLT ERH      SRG INST A-REG.
0160 02343 102301                    SCS
0161 02344 002040                    SEZ
0162 02345 102066                    HLT ERH      E / O SET

```

PAGE 0034 #03 DIAGNOSTIC CONFIGURATOR (CSN 000200)

```

0164*          PRE-TEST PART B (CF)
0165*
0166 02346 062770   LCA SRGEP   0111010001110010
0167 02347 066770   LDB SRGEP           0111010001110010
0168 02350 001500   ERA           0011101000111001 0
0169 02351 005600   ELB           01110100011100100 0
0170 02352 001500   ERA           0001110100011100 1
0171 02353 005600   ELB           11010001110010001 1
0172 02354 001500   ERA           1000111010001110 0
0173 02355 005600   ELB           11010001110010010 1
0174 02356 001500   ERA           1100011101000111 0
0175 02357 005600   ELB           10100011100100100 1
0176 02360 001500   ERA           1110001110100011 1
0177 02361 005600   ELB           01000111001001001 0
0178 02362 001500   ERA           0111000111010001 1
0179 02363 005600   ELB           10001110010010011 1
0180 02364 001500   ERA           1011100011101000 1
0181 02365 005600   ELB           0011100100100111 0
0182 02366 001500   ERA           0101110001110100 0
0183 02367 005600   ELB           00111001001001110 0
0184 02370 005500   ERB           0011100100100111 0
0185 02371 001600   ELA           1011100011101000 0
0186 02372 005500   ERB           10001110010010011 1
0187 02373 001600   ELA           0111000111010001 1
0188 02374 005500   ERB           1000111001001001 1
0189 02375 001600   ELA           1110001110100011 0
0190 02376 005500   ERB           10100011100100100 1
0191 02377 001600   ELA           1100011101000111 1
0192 02400 005500   ERB           01010001110010010 0
0193 02401 001600   ELA           1000111010001110 1
0194 02402 005500   ERB           01101000111001001 0
0195 02403 001600   ELA           0001110100011100 1
0196 02404 005500   ERB           11110100011100100 1
0197 02405 001600   ELA           0011101000111001 0
0198 02406 005500   ERB           00111010001110010 0
0199 02407 001600   ELA           0111010001110010 0
0200 02410 052770   CPA SRGEP
0201 02411 002001   RSS
0202 02412 102066   HLT ERH       SRG E-REG ERRCR
0203 02413 056770   CPB SRGEP
0204 02414 002001   RSS
0205 02415 102066   HLT ERH       SRG E-REG ERRCR
0206 02416 102301   SCS
0207 02417 002040   SEZ
0208 02420 102066   HLT ERH       E / C SET

```

PAGE 0035 #03 DIAGNOSTIC CONFIGURATOR (DSN 000200)

```

0210*
0211*
0212 02421 062770 LDA SRGEP 0111010001110010
0213 02422 066770 LCB SRGEP 0111010001110010
0214 02423 000025 OCT 0025 ERA 0011101000111001 0
0215 02424 004026 OCT 4026 ELB 0 1110100011100100
0216 02425 000025 OCT 0025 ERA 0001110100011100 1
0217 02426 004026 OCT 4026 ELB 1 1101000111001001
0218 02427 000025 OCT 0025 ERA 1000111010001110 0
0219 02430 004026 OCT 4026 ELB 1 1010001110010010
0220 02431 000025 OCT 0025 ERA 1100011101000111 0
0221 02432 004026 OCT 4026 ELB 1 0100011100100100
0222 02433 000025 OCT 0025 ERA 1110001110100011 1
0223 02434 004026 OCT 4026 ELB 0 1000111001001001
0224 02435 000025 OCT 0025 ERA 0111000111010001 1
0225 02436 004026 OCT 4026 ELB 1 0001110010010011
0226 02437 000025 OCT 0025 ERA 1011100011101000 1
0227 02440 004026 OCT 4026 ELB 0 0011100100100111
0228 02441 000025 OCT 0025 ERA 0101110001110100 0
0229 02442 004026 OCT 4026 ELB 0 0111001001001110
0230 02443 004025 OCT 4025 ERB 0 0011100100100111
0231 02444 000026 OCT 0026 ELA 1011100011101000 0
0232 02445 004025 OCT 4025 ERB 1 0001110010010011
0233 02446 000026 OCT 0026 ELA 0111000111010001 1
0234 02447 004025 OCT 4025 ERB 1 1000111001001001
0235 02450 000026 OCT 0026 ELA 1110001110100011 0
0236 02451 004025 OCT 4025 ERB 1 0100011100100100
0237 02452 000026 OCT 0026 ELA 1100011101000111 1
0238 02453 004025 OCT 4025 ERB 0 1010001110010010
0239 02454 000026 OCT 0026 ELA 1000111010001110 1
0240 02455 004025 OCT 4025 ERB 0 1101000111001001
0241 02456 000026 OCT 0026 ELA 0001110100011100 1
0242 02457 004025 OCT 4025 ERB 1 1110100011100100
0243 02460 000026 OCT 0026 ELA 0011101000111001 0
0244 02461 004025 OCT 4025 ERB 0 0111010001110010
0245 02462 000026 OCT 0026 ELA 0111010001110010 0
0246 02463 052770 CPA SRGEP
0247 02464 002001 RSS
0248 02465 102066 HLT ERH SRG E=REG ERRCR
0249 02466 056770 CPB SRGEP
0250 02467 002001 RSS
0251 02470 102066 HLT ERH SRG E=REG ERRCR
0252 02471 102301 SCS
0253 02472 002040 SE2
0254 02473 102066 HLT ERH E / C SET

```

```

0256*          PRE-TEST PART B (CP)
0257*
0258*          BASIC I/O TEST
0259*
0260 02474      BICT  EQL  *
0261 02474 061406      LDA  SWRX
0262 02475 011354      AND  B77
0263 02476 071407      STA  BICSC      SAVE  I1
0264 02477 002003      SZA, RSS      IS  THERE  ONE?
0265 02500 026702      JMP  BICEX      NO  SKIP  BASIC  I/O
0266 02501 011353      AND  B70      CHECK  OVER  7B
0267 02502 002003      SZA, RSS
0268 02503 102066      HLT  ERH
0269 02504 067001      BIC0  LDE  BICSD      UPDATE  I/O  INSTRUCTIONS
0270 02505 160001      LDA  E,I
0271 02506 051366      CPA  M1      END  OF  LIST
0272 02507 026515      JMP  BIC1      YES  =  START  EXECUTION
0273 02510 011372      AND  M77      MASK  OLD  SC  CFF
0274 02511 031407      IOR  BICSC      ADD  NEW  SC
0275 02512 170001      STA  E,I      PUT  IT  BACK  IN  PLACE
0276 02513 006004      INB      MOVE  TO  NEXT  INSTRUCTION
0277 02514 026505      JMP  BIC0+1
0278 02515 065340      BIC1  LDE  B3      SET  TRAP  CELLS
0279 02516 063000      LDA  IHLT      TO  INTERRUPT  HALT
0280 02517 170001      STA  E,I
0281 02520 055354      CPB  B77      END
0282 02521 026524      JMP  **3      YES
0283 02522 006004      INB
0284 02523 026517      JMP  **4
0285 02524 107700      CLC  INTP,C      GENERATE  CRS  TO  ALL  I/O

```

PAGE 0037 #03 DIAGNOSTIC CONFIGURATOR (CSN 000200)

```

0287*          PRE-TEST PART B (CP)
0288*
0289*          BASIC I/O TEST
0290*
0291 02525 102100      STF INTP      TOGGLE INTERRUPT
0292 02526 103100      CLF INTP      FLAG TO CLEAR
0293 02527 102200      SFC INTP      IS IT CLEARED?
0294 02530 102066      HLT ERH      NC = ERRCR
0295 02531 102300      SFS INTP      IS IT NOT SET
0296 02532 002001      RSS
0297 02533 102066      HLT ERH      NC = ERRCR
0298 02534 102100      STF INTP      SET INTERRUPT FLAG
0299 02535 102300      SFS INTP      IS IT SET?
0300 02536 102066      HLT ERH      NC = ERRCR
0301 02537 102200      SFC INTP      IS IT NOT CLEARED?
0302 02540 002001      RSS
0303 02541 102066      HLT ERH      NC = ERRCR
0304 02542 103100      CLF INTP      TURN FLAG OFF
0305 02543 102100      BS01 STF SC      TOGGLE INTERFACE
0306 02544 103100      BS02 CLF SC      CARD FLAG TO CLEAR
0307 02545 102200      BS03 SFC SC      IS IT CLEARED?
0308 02546 102066      HLT ERH      NC = ERRCR
0309 02547 102300      BS04 SFS SC      IS IT NOT SET?
0310 02550 002001      RSS
0311 02551 102066      HLT ERH      NC = ERRCR
0312 02552 102100      BS05 STF SC      SET CARD FLAG
0313 02553 102300      BS06 SFS SC      IS IT SET
0314 02554 102066      HLT ERH      NC = ERRCR
0315 02555 102200      BS07 SFC SC      IS IT NOT CLEAR?
0316 02556 002001      RSS
0317 02557 102066      HLT ERH      NC = ERRCR
0318 02560 016751      JSB BICI      SET INTERRUPT RETURN
0319 02561 002571      DEF BICR1     INTERRUPT TO ERROR
0320 02562 102100      BS08 STF SC      SET THE FLAG
0321 02563 102700      BS09 STC SC      AND CONTROL
0322 02564 102100      STF INTP      TURN I/O SYSTEM ON THEN
0323 02565 103100      CLF INTP      TURN I/O SYSTEM OFF
0324 02566 000000      NCP      GIVE IT A CHANCE TO INTERRUPT
0325 02567 000000      NCP
0326 02570 026573      JMP **3
0327 02571 000000      BICR1 NCP
0328 02572 102066      HLT ERH      INTERRUPT CANT BE TURNED OFF
0329 02573 107700      CLC INTP,C     GENERATE CRS

```

PAGE 0038 #03 DIAGNOSTIC CONFIGURATOR (CSN 000200)

```

0331*          PRE-TEST PART B (CP)
0332*
0333*          BASIC I/O TEST
0334*
0335 02574 107700 BS10 CLC SC,C      RESET SC FLAG AND CONTROL
0336 02575 065345          LDB B10      START WITH LOWEST ADDRESS
0337 02576 055407 BS10 CPB B10SC    IS IT THIS SELECT CODE
0338 02577 026607          JMP B103      YES = SKIP CHECK
0339 02600 062776          LDA ,STF      SET UP
0340 02601 030001          ICR B        INSTRUCTIONS
0341 02602 072604          STA **2
0342 02603 103100 BS11 CLF SC        CLEAR SC FLAG
0343 02604 000000          NCF
0344 02605 102200 BS12 SFC SC        CHECK SC FLAG
0345 02606 102066          HLT ERH      NOT CLEAR THEN ERROR
0346 02607 055354 BS10 CPB B77      IS THAT THE LAST?
0347 02610 026613          JMP **3      YES = MOVE TO NEXT TEST
0348 02611 006004          INE          NO = MOVE TO NEXT SC
0349 02612 026576          JMP B102      AND CHECK IT
0350 02613 107700          CLC INTP,C    CREATE CRS INCASE OF PRIV. INT.
0351 02614 016751          JSB B10I    SET INTERRUPT LINK
0352 02615 002726          DEF B10I0
0353 02616 002400          CLA          CLEAR FLAGS
0354 02617 072635          STA B10JD
0355 02620 072726          STA B10I0
0356 02621 071376          STA TMPA
0357 02622 102700 BS13 STC SC        TURN ON
0358 02623 102100 BS14 STF SC        CARD
0359 02624 102100          STF INTP      AND INTF'IS
0360 02625 102701          STC 1          *
0361 02626 102101          STF 1          *
0362 02627 106701          CLC 1          *
0363 02630 103101          CLF 1          * NO INTERRUPT
0364 02631 126632          JMP **+1,I      * SHOULD OCCUR
0365 02632 002633          DEF **+1      * HERE
0366 02633 116634          JSB **+1,I      *
0367 02634 002635          DEF **+1      *
0368 02635 000000 BS10JC NCF        *
0369 02636 035376          ISZ TMPA      INT. SHOULD BE HERE
0370 02637 035376          ISZ TMPA
0371 02640 103100          CLF INTP      TURN I/O SYSTEM OFF
0372 02641 107700 BS15 CLC SC,C      RESET SC FLAG AND CONTROL
0373 02642 066726          LDB B10I0    DID IT INTERRUPT?
0374 02643 006003          SZB,RSS
0375 02644 102066          HLT ERH      NO = ERROR
0376 02645 065376          LDB TMPA      RETURN CORRECTLY
0377 02646 055337          CPB B2
0378 02647 002001          HSS
0379 02650 102066          HLT ERH      NO = ERROR

```

PAGE 0039 #03 DIAGNOSTIC CONFIGURATOR (LSN 000200)

```

0381*          PRE-TEST PART B (CF)
0382*
0383*          BASIC I/O TEST
0384*
0385 02651 016751          JSB BICI
0386 02652 002663          DEF BICR2
0387 02653 102700      BS16 STC SC          CONTROL CN
0388 02654 102100      BS17 STF SC          FLAG LP
0389 02655 102100          STF INTP        TURN CN INTERRUPTS
0390 02656 106700      BS20 CLC SC          CLEAR SC CONTROL
0391 02657 000000          NCF            GIVE IT A CHANCE
0392 02658 000000          NCF            *
0393 02661 000000          NCF            *
0394 02662 026665          JMP **3
0395 02663 000000      BIOR2 NCF
0396 02664 102066          HLT ERH          CONTROL NOT CLEARED
0397 02665 103100          CLF INTP        TURN INTP'S OFF
0398 02666 016751          JSB BICI
0399 02667 002677          DEF BICR3
0400 02670 102700      BS21 STC SC          TURN CONTROL CN
0401 02671 102100          STF INTP        TURN INTP'S ON
0402 02672 106700          CLC INTP        CLEAR I/O SYSTEM
0403 02673 000000          NCF            GIVE IT A CHANCE
0404 02674 000000          NCF            *
0405 02675 000000          NCF            *
0406 02676 026701          JMP **3
0407 02677 000000      BIOR3 NCF
0408 02700 102066          HLT ERH
0409 02701 107700      BS22 CLC SC,C        TURN OFF DEVICE
0410 02702 107700      BIOCX CLC INTP,C    TURN OFF ALL I/O
0411 02703 061406          LDA SWRX        CHECK IF AUTOMATIC MODE
0412 02704 011361          AND B7700
0413 02705 002002          SZA
0414 02706 027030          JMP CFGR          YES GO TO CONFIGURATION
0415 02707 061406          LDA SWRX        CHECK IF LOOP
0416 02710 011363          AND B10K
0417 02711 002002          SZA
0418 02712 024140          JMP PTLP        YES LOCP
0419 02713 061406          LDA SWRX        RESTORE S-REG.
0420 02714 102601          CTA SWREG
0421 02715 061404          LDA DISN          AND A & B REG
0422 02716 065405          LDB DIBP
0423 02717 102077          HLT 77B        WAIT FOR CONFIGURATION INFORMATION
0424*
0425 02720 107700      CFRG CLC INTP,C    TURN OFF ALL I/O
0426 02721 071404          STA DISN
0427 02722 075405          STB DIBP
0428 02723 102501          LIA SWREG        GET SWITCH REGISTER
0429 02724 071406          STA SWRX
0430 02725 027030          JMP CFGR          GO TO CONFIGURATION

```

PAGE 0040 #03 DIAGNOSTIC CONFIGURATOR (DSN 000200)

```

0432*                PRE-TEST PART B (CP)
0433*
0434*                BASIC I/O TEST
0435*
0436 02726 000000  BICIO NCP
0437 02727 103100          CLF INTP          TURN I/O SYSTEM OFF
0438 02730 066635          LDB BICJD          CHECK TO SE IF ALL
0439 02731 056747          CPB BIOD0          INSTRCTIONS COMPLETED
0440 02732 002001          RSS
0441 02733 102066          HLT ERH          NO - ERROR
0442 02734 066750          LDB BICD1          CHECK RETURN ADDRESS
0443 02735 056726          CPB BICIO          *
0444 02736 026741          JMP **3          *
0445 02737 006004          INB          *
0446 02740 056726          CPB BICIO          *
0447 02741 002001          RSS          *
0448 02742 102066          HLT ERH          *
0449 02743 016751          JSR BICI          SET ERROR IF SECOND INTP
0450 02744 002760          DEF BICE
0451 02745 102100          STF INTP          TURN I/O SYSTEM ON
0452 02746 126726          JMP BICIO,I          CONTINUE TEST
0453*
0454 02747 002634  BIOD0 DEF BICJD-1
0455 02750 002636  BIOD1 DEF BICJD+1
0456*
0457*
0458 02751 000000  BIOI  NCP
0459 02752 166751          LCB BICI,I
0460 02753 036751          ISZ BICI
0461 02754 074003          STB 3B
0462 02755 066777          LDB JSBI.
0463 02756 074000  BSSTB STB SC
0464 02757 126751          JMP BICI,I
0465*
0466*
0467 02760 000000  BICE  NCP
0468 02761 102066          HLT ERH          SECOND INTERRUPT OCCURED
0469 02762 126760          JMP BICE,I
0470*

```

PAGE 0041 #03 DIAGNOSTIC CONFIGURATOR (CSN 000200)

0472	02763	125252	.ALT0	OCT	125252		
0473	02764	052525	.ALT1	OCT	052525		
0474	02765	104447	SRGP1	OCT	104447	10001000100100111	
0475	02766	114040	SRGP2	OCT	114040		1001100000100000
0476	02767	000100	SRGP3	OCT	000100		
0477	02770	072162	SRGP	OCT	072162	011010001110010	
0478	02771	000000	.TMPA	NCF			
0479	02772	000000	.TMPB	NCF			
0480	02773	002061	CJBR3	DEF	JBR3		
0481	02774	002071	CJBR4	DEF	JBR4		
0482	02775	001331	CJBR5	DEF	JBR5		
0483	02776	102100	.STF	STF	0		
0484	02777	114003	JSBI.	JSB	3B,I		
0485	03000	106077	IHLT	OCT	106077		
0486*							
0487*							
0488	03001	103002	BIOSD	DEF	*+1,I		
0489	03002	002543		DEF	BS01		
0490	03003	002544		DEF	BS02		
0491	03004	002545		DEF	BS03		
0492	03005	002547		DEF	BS04		
0493	03006	002552		DEF	BS05		
0494	03007	002553		DEF	BS06		
0495	03010	002555		DEF	BS07		
0496	03011	002562		DEF	BS08		
0497	03012	002563		DEF	BS09		
0498	03013	002574		DEF	BS10		
0499	03014	002603		DEF	BS11		
0500	03015	002605		DEF	BS12		
0501	03016	002622		DEF	BS13		
0502	03017	002623		DEF	BS14		
0503	03020	002641		DEF	BS15		
0504	03021	002653		DEF	BS16		
0505	03022	002654		DEF	BS17		
0506	03023	002656		DEF	BS20		
0507	03024	002670		DEF	BS21		
0508	03025	002701		DEF	BS22		
0509	03026	002756		DEF	BSSTB		
0510	03027	001366		DEF	M1		

BASIC BINARY LOADER LISTINGS

APPENDIX

E

E-1. GENERAL

With the availability of the Configurator and diagnostics on different media and the 2100A/S, 2114A/B, 2115A, and 2116A/B/C computers not having appropriate absolute binary ROM loaders, it will be necessary to toggle the corresponding loader into the last 64 locations of any one page in the available base memory, excluding pages 0, 1, or 2. (The configurator will load into any memory location from 2 to 7677.)

Table E-1 summarizes the four loaders listed in tables E-2 through E-5. Table E-1 also specifies the peripheral product and corresponding interface, subsystem, and loader format.

Table E-1. Basic Binary Loader Reference

LOADER LISTING	ASSOCIATED DEVICE			FORMAT
	PERIPHERAL PRODUCT	INTERFACE	SUBSYSTEM NUMBER	
Table E-2	7900 Cartridge Disc	13210A Disc Interface	12960A	Disc Boot
	7901 Cartridge Disc	13210A Disc Interface	12961A	Disc Boot
Table E-3	7905/20 Cartridge Disc	13175A or 13178B Disc Interface	12962A/B/C/D (For 7905 Only)	Disc Boot
Table E-4	2644/45 CRT Terminal	12966A Buffered Async Interface or 12968A Async Interface	N/A	Absolute Binary
Table E-5	7970B Mag Tape	13181A Mag Tape Interface	12970A	Absolute Binary
	7970E Mag Tape	13183A Mag Tape Interface	12972A	Absolute Binary

E-2. 7900/7901 DISC LOADER

This disc loader loads a program from an HP 7900 or 7901 into memory. Starting at the beginning of cylinder 0, it is used to load from the selected surface of disc drive 0 a block of 128 (decimal) words into memory starting at location 2011 (octal). It then jumps indirect to a subroutine via memory address 2055 (octal) to execute the program just loaded from the disc. This program can be a boot loader which loads the Configurator after RUN is pressed. If the load is not successful, the result is unpredictable and the disc loader may have to be reloaded if a second load execution is desired. Before execution, the S-register must be set to 10 (octal). Table E-2 lists the loading and execution procedure.

E-3. 7905/7920 DISC LOADER

This disc loader loads a program from an HP 7905 or an HP 7920 into memory. Starting at the beginning of cylinder 0, it is used to load from the selected surface of disc drive 0 a block of 128

words into memory starting at location 2011 (octal). It then jumps indirect to a subroutine via memory address 2055 (octal) to execute the program just loaded from the disc. This program can be a boot loader which loads the Configurator after RUN is pressed. If the load is not successful, the result is unpredictable and the disc loader may have to be reloaded if a second load execution is desired. Before execution, the S-register must be set to 10 (octal). Table E-3 lists the loading and execution procedure.

E-4. 2644/45 CARTRIDGE TAPE LOADER

This loader is used to load the Configurator stored on an HP 2644/45 cartridge tape via an HP 12966A Buffered Asynchronous Interface or an HP 12968A Asynchronous Interface into memory. The operator must select via the console the unit and file number prior to starting the loader. (Refer to *HP 2644A Mini Data Station Owner's Manual*, part no. 02644-90001, or to the *HP 2645A Display Station User's Manual*, part no. 02645-90001.) There are no S-register settings required. Table E-4 lists the loading and execution procedure.

E-5. 7970B/7970E MAGNETIC TAPE LOADER

This loader is used to load the Configurator from 9-track magnetic tape (unit 0 only) into memory. Due to the fact that this loader does not have file selection capabilities, it is the responsibility of the operator to ensure that the next file to be read is the Configurator. There are no S-register settings required. Table E-5 lists the loading and execution procedure.

Table E-2. HP 7900/7901 Disc Boot Loader

```

0001          ASMB,A,B,L,C
0003 07700          ORG 7700B
0004*
0005*
0006**** 7900 DISC BOOT LOADER ****
0007*
0008*
0009*      LOAD THE ENTIRE PROGRAM INTO THE LAST 64 LOCATION OF
0010*      ANY ONE PAGE IN BASE MEMORY WITH THE CORRECT SC'S FOR
0011*      THE DATA (DC) AND CONTROL (CC) CHANNELS. BRING THE
0012*      P-REGISTER TO THE STARTING ADDRESS OF THE PROGRAM,
0013*      SET S-REGISTER TO 10 (OCTAL), PRESS PRESET (INT.
0014*      AND EXT.) AND RUN.
0015*
0016*
0017*      SEEK CYLINDER 0, UPPER/LOWER PLATTER, SECTOR 0
0018*
0019 07700 067741  START LDB SEEKC          GET SEEK COMMAND WORD
0020 07701 106600          OTB DC ←        USE WORD FOR ADDRESS 0
0021 07702 103700          STC DC,C ←      AND OUTPUT TO DATA CHANNEL
0022 07703 106601          OTB CC ←        OUTPUT SEEK COMMAND
0023 07704 103701          STC CC,C ←      AND START SEEK
0024 07705 102300          SFS DC ←        HAS CYLINDER ADDRESS BEEN ACCEPTED?
0025 07706 027705          JMP *-1        NO
0026 07707 002400          CLA            SPECIFY HEAD 0 AND SECTOR 0
0027 07710 102600          OTA DC ←        AND OUTPUT TO DATA CHANNEL
0028 07711 103700          STC DC,C ←
0029 07712 102301          SFS CC ←        IS SEEK OPERATION COMPLETED?
0030 07713 027712          JMP *-1        NO
0031*
0032*      DMA INITIALIZATION
0033*
0034 07714 067735          LDB DMACW        GET DMA CONTROL WORD
0035 07715 106606          OTB 6            ISSUE DMA CONTROL WORD
0036 07716 067736          LDB ADDR1        GET MEMORY ADDR AND SPECIFY INPUT
0037 07717 106602          OTB 2            ISSUE MEMORY ADDR
0038 07720 102702          STC 2            SELECT WORD COUNT
0039 07721 067740          LDB CNT          GET WORD COUNT
0040 07722 106602          OTB 2            ISSUE WORD COUNT
0041*
0042*      7900 READ ROUTINE
0043*
0044 07723 106700          CLC DC ←        PREPARE CONTROLLER FOR READ COMMAND
0045 07724 106701          CLC CC ←
0046 07725 063742          LDA READC        GET READ COMMAND WORD
0047 07726 103601          OTA CC,C ←      AND OUTPUT COMMAND
0048 07727 103700          STC DC,C ←      PREPARE DATA CHANNEL FOR READ OPERATION
0049 07730 103706          STC 6,C        START DMA TRANSFER
0050 07731 103701          STC CC,C ←      INITIATE READ OPERATION
0051 07732 102301          SFS CC ←        CHECK FOR TRANSFER FINISHED
0052 07733 027732          JMP *-1
0053 07734 117737          EXIT JSB ADDR2,I  EXIT TO BOOT LOADER
0054*
0055*      CONSTANTS
0056*
0057 07735 120000          DMACW ABS 120000B+DC←SC OF CHANNEL (BITS 15 & 13 SET)
0058 07736 102011          ADDR1 OCT 102011
0059 07737 102055          ADDR2 OCT 102055
0060 07740 177600          CNT DEC -128
0061 07741 030000          SEEKC OCT 030000  SEEK COMMAND WORD
0062 07742 020000          READC OCT 020000  READ COMMAND WORD
0063*
0064 00000          DC EQU 0B
0065 00001          CC EQU DC+1
0066          END
** NO ERRORS *TOTAL **RTE ASMB 750420**

```

Table E-3. HP 7905/20 Disc Boot Loader

```

0001          ASMB,A,B,L,C
0003 07700          ORG 7700B
0004*
0005*
0006**** 7905 DISC BOOT LOADER ****
0007*
0008*
0009*   LOAD THE ENTIRE PROGRAM INTO THE LAST 64 LOCATION OF
0010*   ANY ONE PAGE IN BASE MEMORY WITH THE CORRECT SC FOR
0011*   THE DISC CHANNEL. BRING THE P-REGISTER TO THE STAR-
0012*   TING ADDRESS OF THE PROGRAM, SET S-REGISTER TO 10
0013*   (OCTAL), PRESS PRESET (INT. AND EXT.) AND RUN.
0014*
0015*
0016*   DMA INITIALIZATION
0017*
0018 07700 067716   START LDB DMACW   GET DMA CONTROL WORD
0019 07701 106606           OTB 6     ISSUE DMA CONTROL WORD
0020 07702 067717           LDB ADDR1  GET MEMORY ADDR AND SPECIFY INPUT
0021 07703 106602           OTB 2     ISSUE MEMORY ADDR
0022 07704 102702           STC 2     SELECT WORD COUNT
0023 07705 067721           LDB CNT   GET WORD COUNT
0024 07706 106602           OTB 2     ISSUE WORD COUNT
0025*
0026*   7905 COLD LOAD ROUTINE
0027*
0028 07707 106700           CLC SC    ← PREPARE CONTROLLER FOR COMMAND
0029 07710 002400           CLA        CREATE COLD LOAD READ, HEAD 0, SECTOR 0
0030 07711 103600           OTA SC,C ← OUTPUT COLD LOAD COMMAND
0031 07712 103706           STC 6,C   START DMA TRANSFER
0032 07713 102300           SFS SC    ← CHECK FOR TRANSFER FINISHED
0033 07714 027713           JMP *-1
0034 07715 117720   EXIT JSB ADDR2,I   EXIT TO BOOT LOADER
0035*
0036*   CONSTANTS
0037*
0038 07716 000000   DMACW ABS SC ← SC OF CHANNEL (BITS 15 & 13 CLEARED)
0039 07717 102011   ADDR1 OCT 102011
0040 07720 102055   ADDR2 OCT 102055
0041 07721 177600   CNT   DEC -128
0042*
0043 00000          SC   EQU 0B
0044          END
** NO ERRORS *TOTAL **RTE ASMB 750420**

```

Table E-4. HP 2644/45 Cartridge Tape Binary Loader

0001			ASMB,A,B,L	
0003	07700		ORG 7700B	
0004*				
0005*				
0006***	2644/45		CARTRIDGE TAPE ABSOLUTE BINARY LOADER	
0007*				
0008*				
0009*			LOAD THE ENTIRE PROGRAM INTO THE LAST 64 LOCATION OF	
0010*			ANY ONE PAGE IN BASE MEMORY WITH THE CORRECT SC FOR	
0011*			THE CHANNEL. BRING THE P-REGISTER TO THE STARTING	
0012*			ADDRESS OF THE PROGRAM, PRESS PRESET (INT. AND EXT.)	
0013*			AND RUN.	
0014*			THIS ASSUMES THE INTERFACE IS A 12966 OR 12968	
0015*			THE BAUD RATE IS EXTERNAL	
0016*			THE CARTRIDGE IS POSITIONED AT THE FILE TO BE READ	
0017*			"RUN" CAN NOT BE PRESSED AFTER HALT 77B OR HALT 11B	
0018*				
0019*				
0020	07700	063773	START LDA LDOTP	RESET POINTER
0021	07701	073702	STA **1	
0022	07702	063763	NCW LDA OTP	GET A WORD FROM THE TABLE
0023	07703	037702	ISZ *-1	MOVE TO NEXT WORD IN TABLE
0024	07704	103600	OTA SC,C ←	OUTPUT CURRENT WORD
0025	07705	053771	CPA EOT	END OF TABLE?
0026	07706	027717	JMP NRD	YES - START INPUT
0027	07707	001727	ALF,ALF	IS THIS A CHARACTER?
0028	07710	013772	AND .377	
0029	07711	002002	SZA	?
0030	07712	027702	JMP NCW	NO - DO NEXT CONTROL WORD
0031	07713	103700	STC SC,C ←	PUT CARD IN DATA MODE
0032	07714	102300	SFS SC ←	IS CHARACTER OUT?
0033	07715	027714	JMP *-1	NO - WAIT FOR IT
0034	07716	027702	JMP NCW	YES - DO NEXT CONTROL WORD
0035	07717	017750	NRD JSB INPUT	READ IN FIRST WORD (RECORD COUNT)
0036	07720	005727	BLF,BLF	POSITION COUNT TO LOWER BYTE
0037	07721	007007	CMB,INB,SZB,RSS	MAKE IT NEG AND IS IT EOF?
0038	07722	102077	HLT 77B	YES - END-OF-FILE
0039	07723	006021	SSB,RSS	IF COUNT WAS ALL ONES
0040	07724	102000	HLT 0	THEN TAPE ERROR
0041	07725	077776	STB WCT	SAVE COUNT
0042	07726	017750	JSB INPUT	READ STORE ADDRESS
0043	07727	077774	STB CKSUM	START CHECKSUM
0044	07730	077775	STB ADD	AND SAVE ADDRESS
0045	07731	017750	NWD JSB INPUT	GET WORD TO BE STORED
0046	07732	063775	LDA ADD	CHECK IF ADDRESS
0047	07733	043777	ADA MXAD	IS ABOVE LOADER
0048	07734	002040	SEZ	IS IT?
0049	07735	102055	HLT 55B	YES
0050	07736	177775	STB ADD,I	NO - PUT WORD IN MEMORY
0051	07737	047774	ADB CKSUM	ADD IT TO CHECKSUM
0052	07740	077774	STB CKSUM	
0053	07741	037775	ISZ ADD	MOVE ADDRESS UP ONE
0054	07742	037776	ISZ WCT	FINISHED WITH THIS RECORD?
0055	07743	027731	JMP NWD	NO - READ NEXT WORD
0057	07744	017750	JSB INPUT	YES - READ CHECKSUM
0058	07745	057774	CPB CKSUM	IS CHECKSUM OK?
0059	07746	027717	JMP NRD	YES - READ NEXT RECORD
0060	07747	102011	HLT 11B	NO
0061	07750	000000	INPUT NOP	INPUT ONE WORD FROM INTERFACE
0062	07751	006700	CLB,CCE	ZERO WORD AND START WITH UPPER HALF
0063	07752	102500	LIA SC ←	GET DATA
0064	07753	002021	SSA,RSS	IS IT VALID DATA?
0065	07754	027752	JMP *-2	NO
0066	07755	013772	AND .377	YES - ELIMINATE UPPER HALF
0067	07756	044000	ADB A	ADD DATA TO B REG.
0068	07757	002041	SEZ,RSS	SECOND HALF READ?
0069	07760	127750	JMP INPUT,I	YES - RETURN WITH WORD IN B REG.

Table E-4. HP 2644/45 Cartridge Tape Binary Loader (Continued)

```

0070 07761 005767      BLF,CLE,BLF  NO - MOVE BYTE TO UPPER HALF
0071 07762 027752      JMP INPUT+2  SET LOWER HALF FLAG AND READ IT
0072*
0073 07763 150077  OTP   OCT 150077  MASTER RESET
0074 07764 040740      OCT 40740  INTERFACE CONTROL
0075 07765 030003      OCT 30003  CHAR FRAME CONTROL
0076 07766 000033  CHR1  OCT 33   ASCII "ESC"
0077 07767 050077      OCT 50077  RESET BUFFER STATUS
0078 07770 000145  CHR2  OCT 145  ASCII LOWER CASE "E"
0079 07771 040340  EOT   OCT 40340  INPUT COMMAND WORD
0080*
0081 07772 000377  .377  OCT 377  UPPER HALF WORD MASK
0082 07773 063763  LDOTP LDA OTP  POINTER TO OUTPUT TABLE
0083 07774 000000  CKSUM NOP   CHECKSUM STORAGE
0084 07775 000000  ADD  NOP   ADDRESS STORAGE
0085 07776 000000  WCT  NOP   INPUT WORD COUNT
0086 07777 170100  MXAD  ABS -START  START BINARY LOADER AREA
0087*
0088 00000      SC   EQU 0B
0089 00000      A   EQU 0B
0090 00001      B   EQU 1B
0091          END
** NO ERRORS *TOTAL **RTE ASMB 750420**

```

Table E-5. HP 7970B/7970E Magnetic Tape Binary Loader

0001			ASMB,A,B,L	MAG TAPE LOADER	
0003	07700			ORG 7700B	
0004*					
0005*					
0006****				7970 MAG TAPE ABSOLUTE BINARY LOADER	
0007*					
0008*					
0009*				LOAD THE ENTIRE PROGRAM INTO THE LAST 64 LOCATION OF	
0010*				ANY ONE PAGE IN BASE MEMORY WITH THE CORRECT SC'S FOR	
0011*				THE DATA (DC) AND CONTROL (CC) CHANNELS. BRING THE	
0012*				P-REGISTER TO THE STARTING ADDRESS OF THE PROGRAM.	
0013*				PRESS PRESET (INT. AND EXT.) AND RUN.	
0014*					
0015*					
0016	07700	067753	START	LDB RDCMD	GET READ COMMAND
0017	07701	106601		OTB CC ←	OUTPUT COMMAND
0018	07702	102501		LIA CC ←	CHECK IF REJECTED
0019	07703	001323		RAR,RAR	
0020	07704	001310		RAR,SLA	??
0021	07705	027701		JMP *-4	YES, TRY AGAIN
0022	07706	103701		STC CC,C ←	NO, START COMMAND
0023	07707	103700		STC DC,C ←	START DATA CHANNEL
0024	07710	102201	WFST	SFC CC ←	CHECK FOR STATUS
0025	07711	027743		JMP STAT	YES
0026	07712	102300		SFS DC ←	ANY DATA
0027	07713	027710		JMP *-3	NO
0028	07714	107500		LIB DC,C ←	YES GET IT (RECORD COUNT)
0029	07715	005727		BLF,BLF	POSITION COUNT TO LOWER BYTE
0030	07716	007000		CMB	MAKE IT NEGATIVE
0031	07717	077755		STB WCT	SAVE INPUT COUNT
0032	07720	102201		SFC CC ←	CHECK FOR STATUS
0033	07721	027743		JMP STAT	YES EXIT TO STATUS
0034	07722	102300		SFS DC ←	WAIT TO READ NEXT WORD
0035	07723	027720		JMP *-3	
0036	07724	107500		LIB DC,C ←	GET LOAD ADDRESS
0037	07725	074000		STB 0	START CHECKSUM
0038	07726	077756		STB CMD	AND ADDRESS POINTER
0039	07727	027733		JMP **4	
0040	07730	177756	NWD	STB CMD,I	PUT WORD IN MEMORY
0041	07731	040001		ADA 1	ADD IT TO CHECK SUM
0042	07732	037756		ISZ CMD	MOVE UP ADDRESS
0043	07733	102300		SFS DC ←	WAIT FOR NEXT WORD
0044	07734	027733		JMP *-1	
0045	07735	107500		LIB DC,C ←	GET DATA TO STORE IN MEMORY
0046	07736	037755		ISZ WCT	FINISHED WITH DATA?
0047	07737	027730		JMP NWD	NO READ NEXT WORD
0048	07740	054000		CPB 0	IS CHECKSUM OK?
0049	07741	027710		JMP WFST	YES - WAIT FOR COMMAND CHANNEL STATUS
0050	07742	102011		HLT 11B	NO
0052	07743	102501	STAT	LIA CC ←	GET STATUS
0053	07744	001727		ALF,ALF	POSITION EOF BIT
0054	07745	002020		SSA	IS IT EOF?
0055	07746	102077		HLT 77B	YES
0056	07747	001727		ALF,ALF	REPOSITION STATUS
0057	07750	001310		RAR,SLA	YES READ OK?
0058	07751	102000		HLT 0	NO TELL OPERATOR
0059	07752	027700		JMP START	YES READ NEXT RECORD
0060*					
0061*					
0062	07753	001423	RDCMD	OCT 1423	MT READ A RECORD COMMAND
0063	07754	000203	FFC	OCT 203	MT FILE FORWARD COMMAND
0064	07755	000000	WCT	NOP	INPUT WORD COUNT
0065	07756	000000	CMD	NOP	
0066*					
0067	00000		DC	EQU 0B	
0068	00001		CC	EQU DC+1	
0069				END	
**	NO ERRORS	*TOTAL	**RTE	ASMB 750420**	



MANUAL PART NO. 02100-90157
Printed in U.S.A. October 1980

HEWLETT-PACKARD COMPANY
Data Systems Division
11000 Wolfe Road
Cupertino, California 95014