

DATA COMMUNICATIONS

DPS 7 GCOS 7

**Communications Processing Facility
Volume 1 : Communications Overview**

SOFTWARE

SOFTWARE

SOFTWARE

SOFTWARE

SOFTWARE





DATA COMMUNICATIONS

DPS 7 GCOS 7

Communications Processing Facility Volume 1 : Communications Overview

Software

Subject

: This manual gives an overview of the GCOS networking environment and describes the way it implements DSA concepts.
New products available in the current release are, DSAC, AUPI and BNSE. They are described in Section V.

Special Instructions

: This manual belongs to a set of three volumes which deal with the subject "Communications Processing Facility", namely,
. 47 A2 01UC Communications Overview
. 47 A2 02UC Network Generation
. 47 A2 03UC MCS User Guide.
With respect to Revision 0, change bars denote additions or modifications, while asterisks denote deletions.

Software Supported

: GCOS 7-LS Release V2
GCOS 7-MS Release V2
GCOS 7-ES Release V2

Date

: July 1985

BULL

CEDOC - CELOG

BP 110 Parc Industriel d'Incarville
27100 VAL DE REUIL - FRANCE

47 A2 01UC REV1

© CII HONEYWELL BULL 1985
Dépot légal
3ème trimestre 1985

Printed in France

Suggestions and criticisms concerning the form, content, and presentation of this manual are invited. A form is provided at the end of this manual for this purpose.

This document is issued for information purposes only. It does not involve CII-HB's responsibility in case of damage resulting from its implementation. Corrections or modifications will be made without prior notice and brought to the knowledge of subscribers by appropriate updatings.

PREFACE

This manual is the first of three volumes dealing with the subject "Communications Processing Facility".

The Communications Overview Manual describes how the DPS 7 implements DSA concepts in the environment of both secondary and primary networks. It explains the relationship between the Communications Network Configurator (CNC) commands and their associated DSA function. This manual is therefore intended to be used with the Network Generation Manual, which is the second volume of "Communications Processing Facility".

In the three volumes of "Communications Processing Facility", the term "64/DPS 7" is synonymous with "DPS 7", the prefix "64" being a "carry-over" from previous releases. GCOS is used to designate DPS 7 software.

The only public data network dealt with is TRANSPAC, which is the X25 packet switching network in France, and the use of which is contracted by PTT subscription.

This manual is intended for all personnel of the DPS 7 network processing installation in understanding the structure and function of their system.

Section I describes the way that DSA relates to the DPS 7 system. It explains how the DPS 7 distributes and implements the various DSA layers. It gives the correspondence between the network objects, created by CNC, and GCOS communications components, and DSA elements.

Section II defines the networking environment and gives an overall description of the GCOS communications components that support it. It relates these components to the principal DSA layers that they occupy, and gives a resumé of what these components do and how they interact with each other.

Sections III and IV describe in detail the mechanism of establishing the network connection, the transport connection and the logical connection between correspondents of the network. Each of the networks described, is related to the set of CNC commands for creating it.

Section III deals with the networks accessed over the URP. It describes in detail the functions of the URP, BTNS and TNS.

Section IV deals with the networks accessed over the DN7100. It describes in detail the functions of the DN7100 and FNPS.

Section V describes the services offered by DSAC and how it is architecturally implemented. It also treats the access provided by AUPI to administrative data in the DSA network.

Appendix A describes the TRANSPAC network and how its various components function. Each of the network objects concerning TRANSPAC are related to the CNC commands and their associated parameters.

The following publications provide the relevant details to the immediate networking environment

- For a description of Distributed Systems Architecture
 - . 38A4 9725 DSA Concepts
- For references to the syntax and description of the CNC commands
 - . 47A2 02UC Network Generation
- For the GCOS communications operator interface
 - . 47A2 04UC Terminal Operations
 - . 47A2 05UC Network Control Operations
- For a functional description of the DN7100
 - . 39A2 9808 DNS System Introduction
- For starting-up and generating the network on the DN7100
 - . 39A2 8024 DN7100 System Generation
- For GCOS management of the DN7100
 - . 47A2 06UC Network Administrative Supplement
- For a functional description of DSAC and details on the ASF log function
 - . 47A2-15UC DSAC User Guide
- For a functional specification of AUPI
 - . 47A2-16UC AUPI User Guide

CONTENTS

Section I	Introduction	1-01
	The Advantages of Layered Architecture	1-02
	How DSA Layers are Structured	1-04
	Information Processing	1-04
	Application Layer	1-04
	Presentation Layer	1-04
	Message Management	1-04
	Session Layer	1-04
	Communications Management	1-05
	Transport Layer	1-05
	Transport Protocol Options	1-05
	Network Layer	1-06
	Data Link Layer	1-06
	Physical Link Layer	1-06
	How DSA Layers are Distributed	1-07
	Handling Data across the DSA Layers	1-09
	Mapping Objects of the Primary Network	1-10
	Mapping Session Objects	1-12
	Mapping Transport Objects	1-14
	Mapping Network Objects	1-16
	Mapping Data Link Objects	1-20
	Mapping DSA Elements on GCOS Communications Components	1-22
	Mailboxes	1-24
	Terminal Mailbox	1-24
	Application Mailbox	1-24
	Administrative Mailbox	1-25
	Workstations	1-26
	BTNS Workstation	1-26
	TNS Workstation	1-26
	FNPS Workstation	1-27
	Service Workstation	1-27
	TDS Workstation	1-28
	QMON Workstation	1-28
	Logical Connection	1-29
	Session	1-29

Section II	GCOS Support of Networks	2-01
	Types of Networks	2-02
	Communications Components	2-04
	Communications Services	2-06
	RBF6/FTF6	2-06
	DJP/DFT	2-06
	IOF	2-06
	TDS	2-07
	DSAC	2-07
	TILS	2-07
	OLTD	2-07
	MCS	2-08
	NASF	2-08
	User Defined Applications	2-08
	Message Management	2-09
	Communications Management	2-10
	BTNS	2-10
	TNS	2-10
	FNPS	2-11
	ADM	2-11
	Communications Network Configurator (CNC)	2-12

Section III	Networks Connected via the URP	3-01
	Communications over BTNS	3-02
	URP Local Network	3-02
	Communications over TNS	3-04
	TRANSPAC/URP Secondary Network	3-04
	PAD Terminals	3-06
	CSX25 Terminals	3-07
	TNS Primary Network	3-08
	Network Route Management	3-10
	Transport Connection Management	3-10
	Functional Description of the URP	3-11
	Universal Communications Line Adaptor (UCLA)	3-11
	Multiline Attachment (MLA)	3-11
	Functional Description of BTNS	3-13
	Line Monitor	3-13
	I/O Request Supervisor	3-13
	Line Drivers	3-13
	Terminal Drivers	3-14
	Secondary Network Controller	3-15
	Local Dialog Handler	3-15
	Connection Handler	3-15
	Connection from a Terminal to an Application	3-16
	Connection from an Application to a Terminal	3-16
	Secondary Network Administration	3-17

Section III (continued)

Functional Description of TNS	3-18
DSA Transport Station (MUX)	3-19
Network Connection and Resource Manager (ENCRM)	3-19
X25 Level 3	3-20
Asynchronous Access Method (ASAM)	3-20
HDLC Driver	3-20

Section IV	Networks Connected via the DN7100	4-01
	Communications over FNPS	4-02
	DN7100 Local Network	4-02
	TRANSPAC/DN7100 Secondary Network	4-04
	FNPS Primary Network	4-06
	Functional Description of the DN7100	4-08
	Links Management	4-08
	Terminal Manager	4-08
	Transport and Routing Management Services	4-09
	Functional Description of FNPS	4-10
	Transport Module (TPM)	4-10
	Events Manager (TPMEVT)	4-12
	Administrative Function (ADCOM)	4-12
	I/O Driver (PIO)	4-12

Section V	Distributed Systems Administration and Control	5-01
	DSAC Services	5-02
	Commands and Responses	5-02
	Journalization	5-03
	DSAC Objects	5-04
	Administrative Functions	5-05
	Administrative Correspondents	5-06
	Administrative Groups	5-07
	Administrative Filters	5-08
	Administrative Logs	5-09
	Correspondent Types	5-10
	Overview of Correspondent Types	5-11
	DSAC Implementation Overview	5-12
	Connections to AF LNAD	5-13
	Connections to AF DSALOG	5-13
	Journalization	5-14
	Local Journalization	5-14
	Remote Journalization	5-14
	Schema of Journalization	5-15
	Use of Filters during Journalization	5-16
	Operating the DSAC Session	5-17
	Administrative Utilities Programmatic Interface	5-18
	Schematic Overview of AUPI	5-19
	Basic Network Session Exercizer	5-20
	Schematic Overview of BNSE	5-21

Appendix A	Access over TRANSPAC	A-01
	Description of the TRANSPAC Network	A-02
	Virtual Circuits	A-04
	Subscriber and Subscription	A-05
	Packets and Packet-Switching	A-06
	Features of the Packet-Switching Network	A-07
	PAD Service	A-07

SECTION I

INTRODUCTION

Distributed Systems Architecture (DSA) defines a functional model of Open Systems Interconnection (OSI).

Being "open", such a networking model is flexible enough to keep pace with changes in technology and user demands.

The advantages are twofold

- . firstly, the actual network processing is not visible to the user
- . and, secondly, the network itself can be more flexibly reconfigured.

THE ADVANTAGES OF LAYERED ARCHITECTURE

The whole purpose of a network is to enable the user at a terminal to communicate with an application available and executing in any one of the configured systems.

The less the user and the application are aware of the physical network, the more both correspondents can devote their resources to actual data processing.

In order to achieve this, DSA structures network services in layers, each of which acts independently of the others, and is solely responsible for its own task.

Each layer provides other layers the unconditional assurance that the data it transmits is error-free and in the same logical order as when received.

The net result of such mutual reliance and cooperation between layers is that data reconstituted on reception is a facsimile of data when disassembled on emission.

How the layer accomplishes its task is in the observance of its protocol which is a set of rules governing the processing and transmission of the data entity with which the layer is associated. Each layer has its own data entity and its own protocol.

For as long as interconnected systems observe a common norm, in this case the DSA standard, layers of the same level can dialogue directly.

The DSA standard ensures that the transmission of data from user to application, and vice versa, occurs with neither correspondent being aware of the physical components of the network between them or of the techniques used to maintain communication. As far as the both correspondents are concerned, it is as though they were within the same site.

Functional Example
of
Layered Architecture

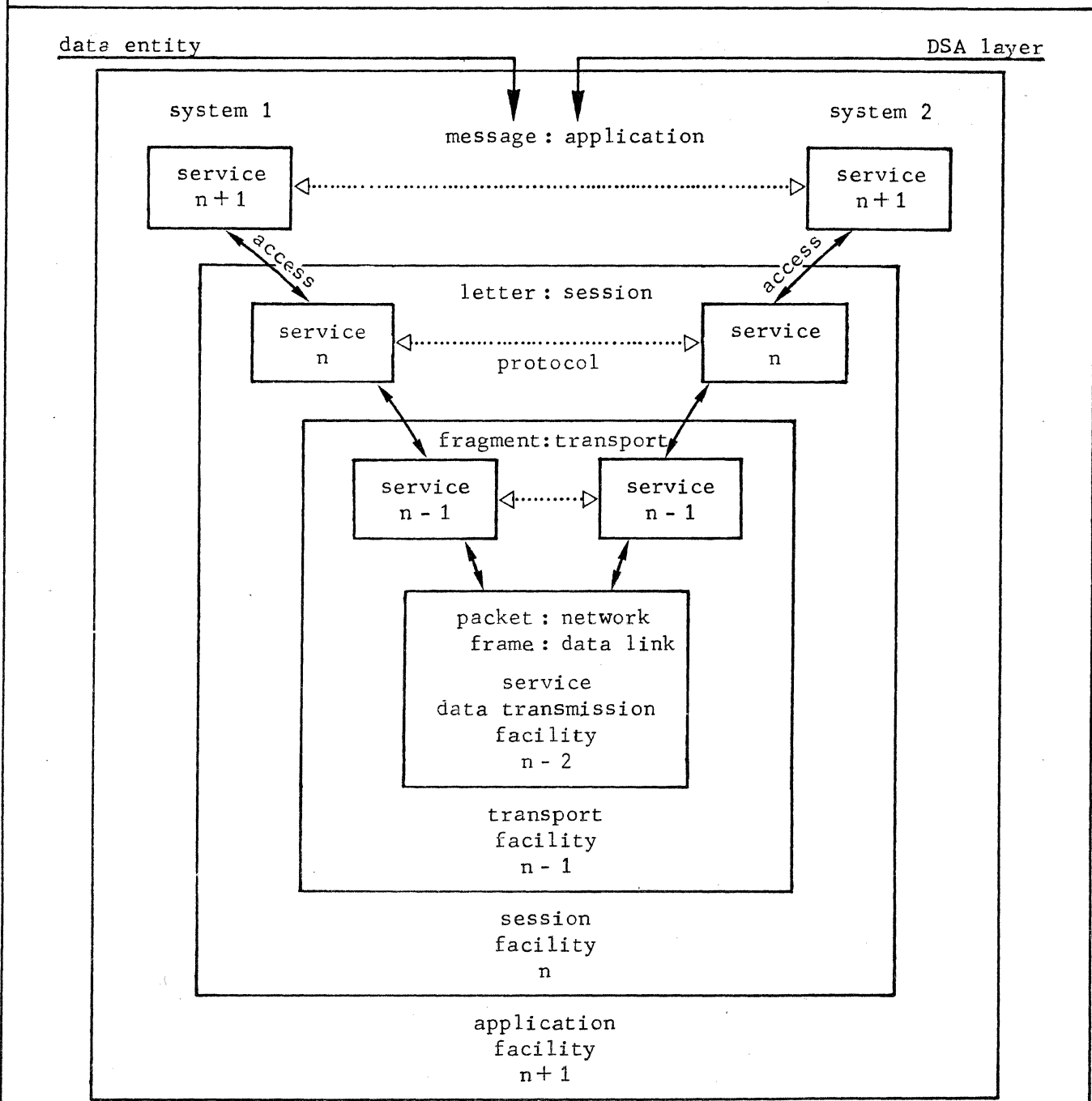

This diagram identifies the principal DSA layers and their associated data entities. The innermost rectangle represents the network link which is at the lowest layer, while the outermost rectangle represents the highest level of activity, representing the application and the user accessing it.

Layers of the same level share a common protocol which governs the transfer of data and the access to successive layers.

A facility defines a group of functions provided by a level of service.

HOW DSA LAYERS ARE STRUCTURED

Any communications architecture is concerned with three principal functions

- . processing data
- . and, inputting and outputting data between application and user, which involves
 - firstly establishing their connection
 - and secondly, maintaining and managing their communication.

DSA layers are structured in the following way to implement these three functions.

Information Processing

Information processing is the highest level of all activities. It comprises the actual processing of data and the way that data is presented to both the application and the user.

APPLICATION LAYER

The application layer is concerned with data processing and is occupied by applications, each of which is identifiable by its own mailbox within its system.

In GCOS, applications are synonymous with "communications services" and are packaged products like IOF and TDS, and user-defined MCS applications.

PRESENTATION LAYER

The presentation layer provides a data transformation service so that

- . data input to the application is independent of the hardware characteristics of the real terminal
- . and, data output to the user is displayed in a "readable" format.

In GCOS, the FORMS package comprising the utilities H_FORMGEN and H_FORMRTP is used to provide a formatting service for synchronous terminals in an IOF or a TDS environment.

Message Management

Message management is concerned with the interactive transmission of data between mailboxes, representing the application and the user accessing it.

Both application and user have unique DSA addresses of the format s.m, where

- . s is the "session-name" and is unique throughout the network
- . and, m is the "mailbox-name" local to a system and unique only for that system.

The presentation layer and the session layer implement message management.

SESSION LAYER

The session layer provides direct access between the correspondents with neither being aware of the other's location, or of the communications path or mechanism used to ensure this access. However, if the correspondents are in different systems, the session layer invokes communications management for the service provided by the transport layer.

Communications Management

Communications management handles all functions involved in transporting data over a communications medium between systems in different physical locations.

TRANSPORT LAYER

The transport layer is the entry point into the communications network. It provides the connection independent of the medium over which the transport function is implemented. However, transport protocol options can be specified by the user to ensure the grade of transport service according to the type of application and the nature of the physical link.

Each physical system has its own unique transport station through which all communications pass.

Transport Protocol Options

Transport protocol options determine the techniques and rules for

- . transport negotiation
- . regulation of data traffic
- . and, data error recovery.

In GCOS, these options are specified as arguments for the LEVEL parameter of the XPRTC command at network generation.

The options, in the following increasing levels of functional importance, are

- . Level 0 : SLAVE
The correspondent has no choice, not even to negotiate a connection. Instead, the DPS 7 "local system" imposes its own techniques and rules.
- . Level 1 : BASIC
The correspondent only has the right to connect to the DPS 7 "local system" but has no choice in selecting the techniques and rules.
- . Level 2 : FLOW (FLOW_CONTROL)
Both correspondents can initiate connection and regulate data traffic, but neither imposes error recovery.
- . Level 3 : RQST (RQST_RECOVERY)
Both correspondents can initiate connection and regulate data traffic, but only partial error recovery is possible on demand to retransmit by the receiver.
- . Level 4 : FULL (FULL_RECOVERY)
Both correspondents can initiate connection and regulate data traffic, and full error recovery is supported on demand to retransmit by either the sender or receiver, or both.

physical link application type	single path		multipath
	point-to-point	X25 with error notification	
transactional	BASIC	RQST	FULL
file transfer/remote batch	FLOW	RQST	FULL

NETWORK LAYER

The network layer provides the functional and procedural means for routing data between the transport layers of sender and receiver, across one switcher machine to the next.

DATA LINK LAYER

The data link layer manages and maintains data transmission between participating systems through HDLC lines of the communications network.

Each HDLC line configured over TRANSPAC to the DPS 7 must be declared

- . at the one end on the side of the DPS 7, as a DTE (Data Terminal Equipment)
- . and, at the other end on the side of the switcher machine, in this case, TRANSPAC, as a DCE (Data Circuit-terminating Equipment).

For a point-to-point HDLC line, it does not matter which side declares its end of the line as DTE or DCE. For as long as both ends are declared a DTE-DCE pair, the circuit, whatever the type of line, can be established.

In GCOS, the declaration of its end of the HDLC line is specified in the TERMD parameter of the LN command for the TLT (Terminal and Line Table) of the URP firmware generation.

PHYSICAL LINK LAYER

The physical link layer is composed of all the hardware and its interfaces needed to support the network link.

HOW DSA LAYERS ARE DISTRIBUTED

The DPS 7 connects to the network

- . either through the Data Communications Controller of its own integrated URP
- . or through the DN7100 acting as its "front-end" processor.

DSA layers are spread differently according to the type of connection.

DN7100 Connection :

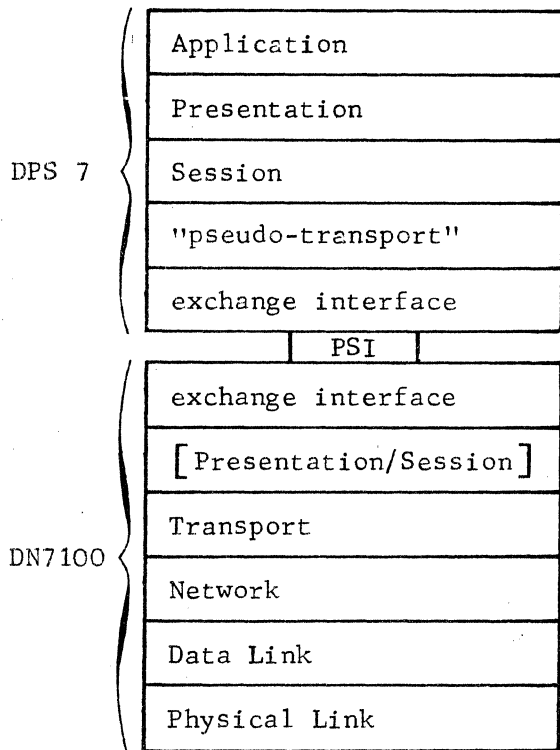

URP Connection :

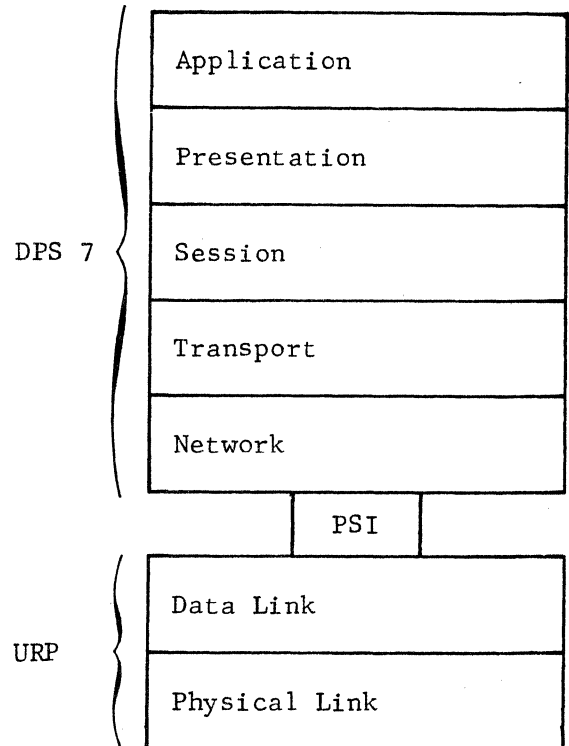

In the URP connection, the DSA layers are distributed without overlap and correspond one-to-one with the DSA standard.

In the DN7100 connection, however, additional "services" are present to ensure the "access" between the systems, the DPS 7 and the DN7100, and the type of network configured to the DN7100, namely

- . the "pseudo-transport" in the DPS 7
- . the exchange interface present in both the DPS 7 and the DN7100
- . the Presentation/Session Layers of Message Management in the DN7100 in the case where a secondary network is configured.

Data
Disassembly and Reconstitution
across DSA Layers

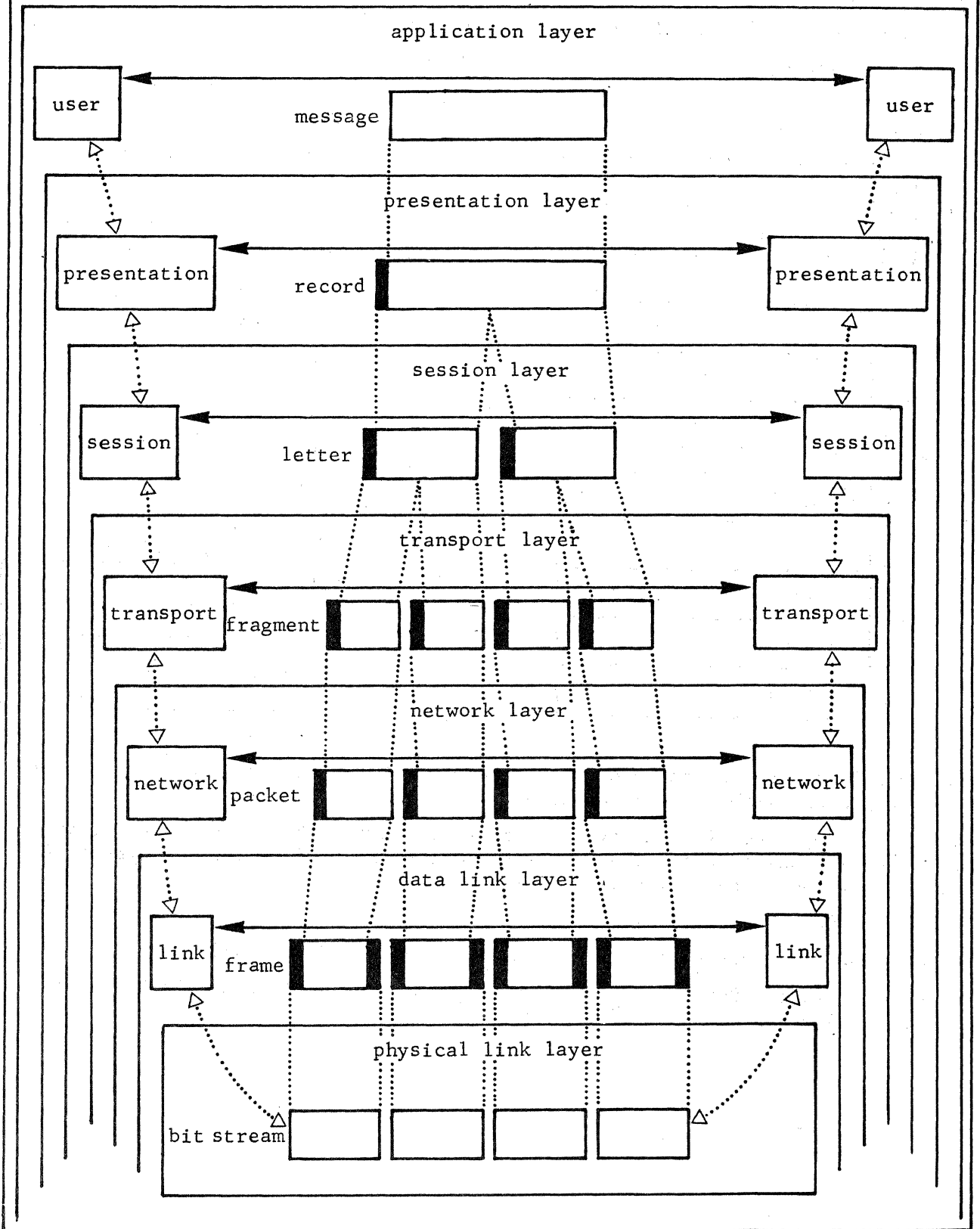

HANDLING DATA ACROSS THE DSA LAYERS

In any data processing installation, there is no restriction on the quantity of data transmitted by either user or application. As far as both are concerned, they send or receive data in a continuous stream.

As this data is moved across the DSA layers, it is broken down into units most conveniently and efficiently handled by the layer concerned. The sizes of these units are determined by the constraints imposed at the different layers, namely

- . internal constraints, being the buffers available that limit throughput and redundancy checks that increase overheads
- . and, external constraints, being the capacity of the public network that sets a ceiling on the speed and hence the volume of data to be carried.

As data is passed down, the next lower layer breaks it down into its own units and tags on a header to each of the units. This header is then treated as part of the data in the subsequent lower layer which in turn performs its equivalent action.

The header contains control information such as the type of information, status of transmission, sequencing of units and addresses.

At the lowest layer, data is transmitted as a bit stream across the network. On the other side of the network, this data is passed to the next higher layer which proceeds to assemble the bit stream into its constituent units. As data is passed up, the next higher layer strips the header off each of the units received and reconstitutes the data into its own units. Each successive higher layer performs its own equivalent action.

The net result of breaking down and reconstituting data is that what is received at the destination is a facsimile of that sent from the source since it is protected against error and loss. Each layer has its own specific protocol to govern the transfer of its data to the next successive layer. The information contained in the header is part of the protocol used as a control to ensure that the data is properly delivered in the same logical sequence as received whatever the direction of the transfer.

MAPPING OBJECTS OF THE PRIMARY NETWORK

In GCOS, the Communications Network Configurator (CNC) utility is used to generate the network. When CNC is executed, it builds up a set of network objects according to what has been declared. These objects reflect the network configuration and resources available to the user, and the intended use of the network.

When the communications session is started up through the ST network control command, these objects provide the relational links to each other for the network to operate.

The network objects under discussion here concern the primary network configured through the URP of the DPS 7 since all the objects relate to DSA layers and are visible to, and declarable by the user.

The diagram on the facing page shows an ensemble of such objects.

While the primary network object is associated with a DSA layer, it cannot function on its own. Instead, a group of objects interact together across DSA layers to provide the function associated with one given layer.

An object can participate in more than one group. This overlap occurs when the object performs more than one role. Mapping network objects is a means of representing their correlational groupings.

In the text that appears on the following pages, objects are mapped not to the layer but to the function that the associated layer provides.

"Mapping Transport Objects" does not restrict mapping only the objects concerned with the transport layer. Instead, all the layers higher up from the transport layer are involved in the function of transport. Multiplexing protocol which is part of transport protocol is dealt with at the lower level "Mapping Network Objects" since the virtual circuit must be established before multiplexing takes place.

The network object takes the name of the CNC command only if it wholly bears a one-to-one correspondence with it, e.g. NR and CP. Although this is the case with LSYS and RSYS, LSC and RSC, and, LTS and RTS, group identifiers have been used for simplicity, namely, SYS, SC and TS.

The designations "cp" and "rts" are abbreviations for "communications path" and "remote transport station" as opposed to CP and RTS as CNC commands.

The designations "lns" and "rns" denote that values must be substituted for these terms, that is, decimal values, as opposed to LNS and RNS as network objects.

A network composed of point-to-point leased lines is a "native" network since no external constraints are imposed such as cumulative transit time and times of transmission. However, an X25 packet switching network, like TRANSPAC, being a public data network does impose such restrictions and therefore is a "foreign" network.

Each time that the CNC description refers to an access to such a "foreign" network, the object FRGN is created to which all remote subscription numbers (RNS) accessing it, are attached.

Mapping Objects
of the
Primary Network

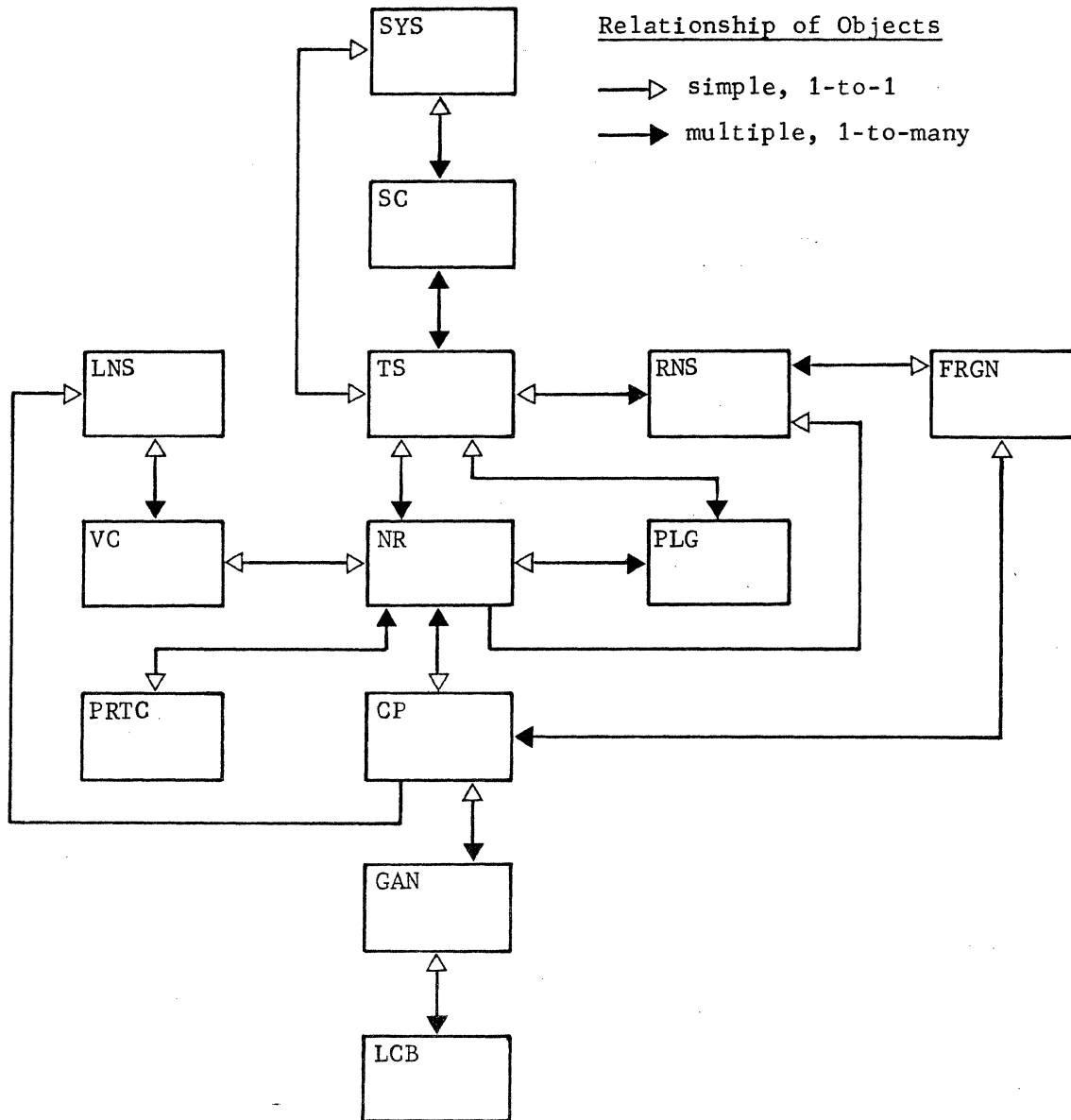

List of Abbreviations and Mnemonics

CP Communications Path
FRGN Foreign Network
GAN General Access Network Table
LCB Line Control Block
LNS Local Network Subscription
NR Network Route

PLG Plug
PRTC Protocol
RNS Remote Network Subscription
SC Session Control
SYS System
TS Transport Station
VC Virtual Circuit

Mapping Session Objects

The session is identified by its appropriate SC command at network generation by the following

- a unique global external name (session name) which is
 - either specified as a positional parameter immediately after the name of the command
 - or implicitly taken from the name of the DPS 7 configuring the network, that is, the "local system"
- and, a unique internal network address specified as the argument of the SCID (session control identifier) parameter.

The relationship between session objects is

- firstly, that there can be more than one session in a system
- and secondly, that the session(s) is/are always serviced by at least one transport station.

The system, declared by its appropriate SYS command at network generation, has the notional concept of being a "container" into which objects, determining its function, are built. The system, as a network object, is "seen" by other users of network through its session or specific session, where more than one is declared.

Applications which represent the highest level of activities, can be regarded as the "contents" of the system. Applications are identifiable through their mailboxes. Since applications are local to the system, the names of their mailboxes need not be unique throughout the network. The application, like the user, is identified by its DSA address of the format <session-name>.<mailbox-name> which is unique throughout the network.

In the first stage of connecting the application to the user accessing it, the logical connection for both the correspondents must be established at their respective locations. This connection as implemented by session protocol is between the mailbox, on the one hand, and, on the other hand, the subchannel (SBC) which represents the functional interface to the respective transport station.

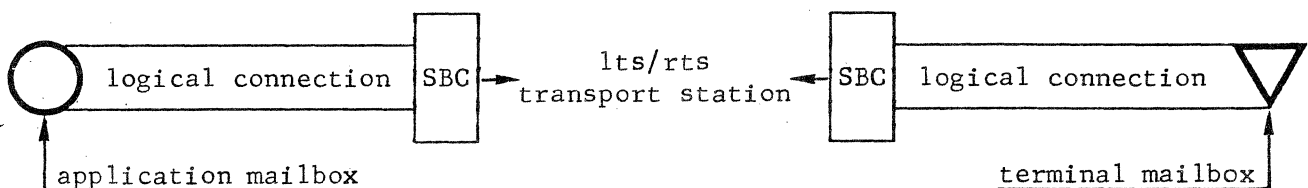

Communications management involving the transport service is now required to provide the access between the "local system" and other "remote systems". The transport station provides this access by handling all communications to and from the system. For virtual circuits, transport protocol multiplexes logical connections over the same path to optimize the system's accessibility.

In the case of the primary network being configured through the DN7100 functioning as the "front-end system" of the DPS 7, the only mappable network objects are the system, the session and the "transport". No other network object is visible since the DPS 7 is relieved of most of its DSA administrative functions by the DN7100. The "transport" defines the transport service and not the transport station. This "transport" is declared in the FNP command at network generation and maps the DN7100 over the PSI of the DPS 7.

Mapping Session Objects

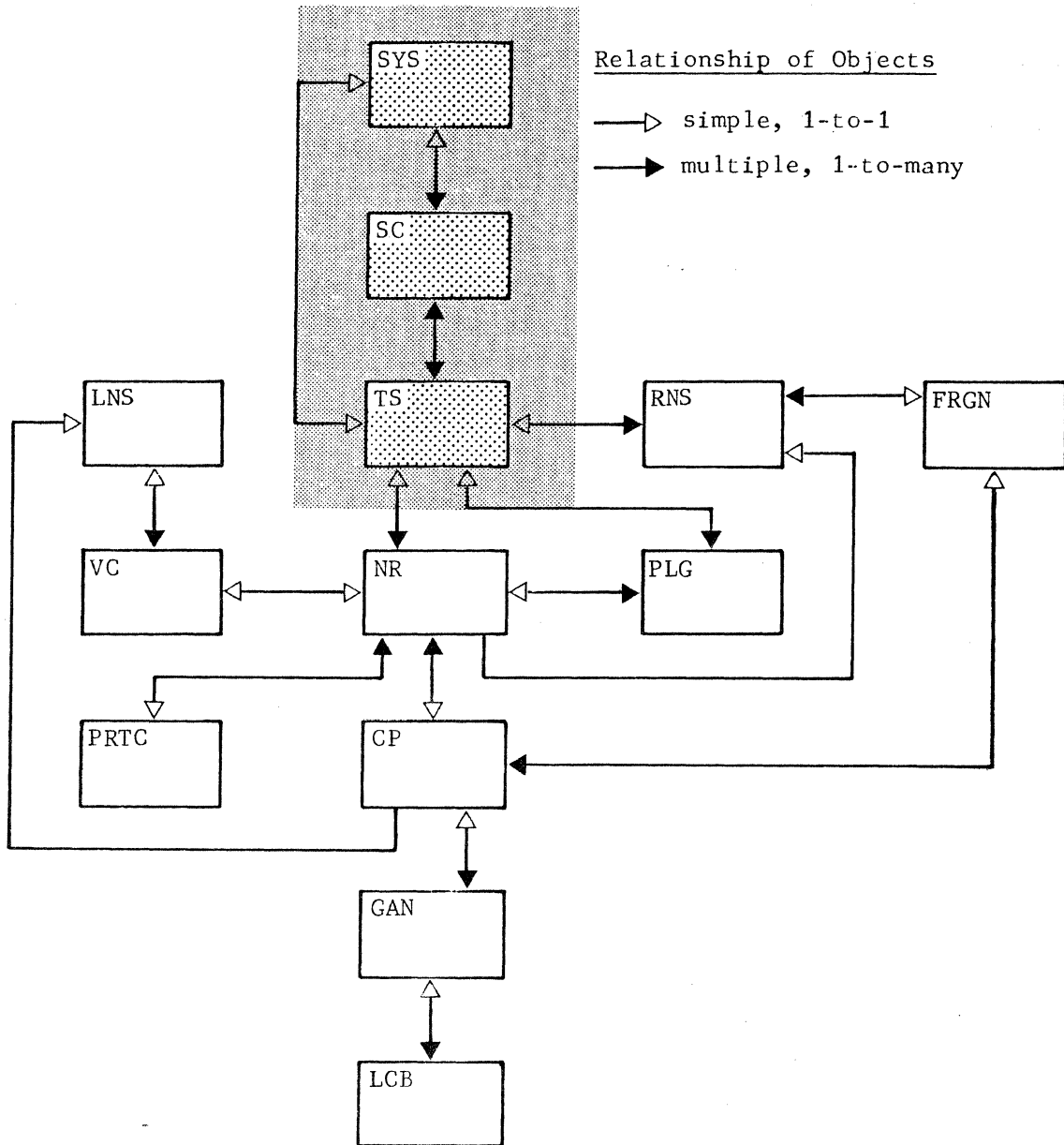

The objects in the session layer are generated by the following CNC commands

- SYS - LSYS or RSYS
- SC - LSC or RSC
- TS - LTS or RTS.

The relationship between the objects is as follows,

- there may be several SC processes in a single SYS
- while SC processes are always serviced by a single TS, the SC itself may be serviced by several TSs.

Mapping Transport Objects

The transport station is "concatenated" to its associated session through its name being specified as the argument of the TS parameter in the preceding SC command. If more than one transport station is to serve a given "remote session", the list of rts's must appear in the TS parameter of the relevant RSC command, followed by as many RTS commands. However, the LTS command, like the LSYS and LSC commands, is unique in the CNC description.

Since the transport station is strictly local to its own session, its name need not be network-wide.

In the connection between the lts and rts, both transport stations can be considered the physical ends of a conduit, the conduit itself being provided for by one or a number of network routes. Each of these network routes is defined for a given rts and represents a localized image of the physical path available to the lts to "exit" to the rts.

The conduit, so far established, assures the connection between the transport stations. This connection as implemented by transport protocol is between plugs, each plug representing a table for updating the dynamic context of its being matched one-for-one with its correspondent.

In the second stage of connecting the application to the user accessing it, the plugs of the transport connection link up with the subchannels of their respective logical connections.

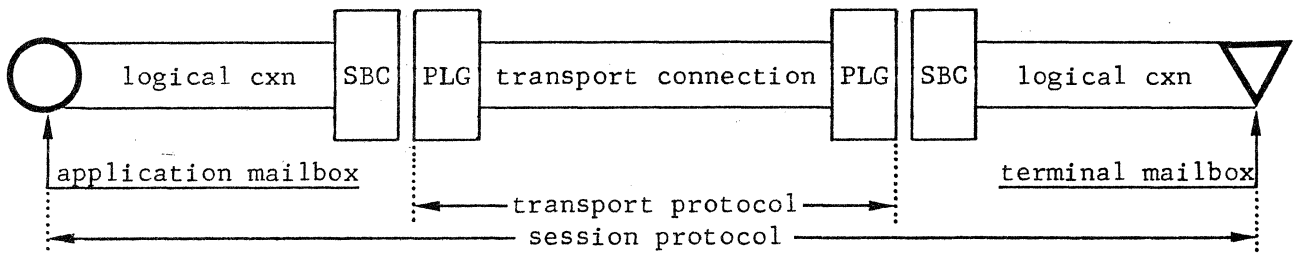

For a point-to-point line, the connection between the application and the user is complete since there is direct multiplexing between the logical connection and the transport connection.

At the time of connection, the two transport stations negotiate the number of fragments (window) and the size of the fragment for their flow control. The window defines the number of fragments that the sender station can transmit before waiting for an acknowledgement from the receiver.

A switched public data network, such as an X25 packet switching network or an X21 circuit switching network, is considered an foreign network (FRGN).

In the case where such a network is used, the following relationships are involved

- the rts is accessed through a list of remote subscription numbers (RNS) to establish the virtual circuit
- all the RNSs declared are mapped on to the FRGN
- and, the administrators of both the "local system" and the "foreign network" must agree on a common local subscription number (LNS) to access the "remote system" through the FRGN.

The LNS is used for connection by the network protocol.

Mapping Transport Objects

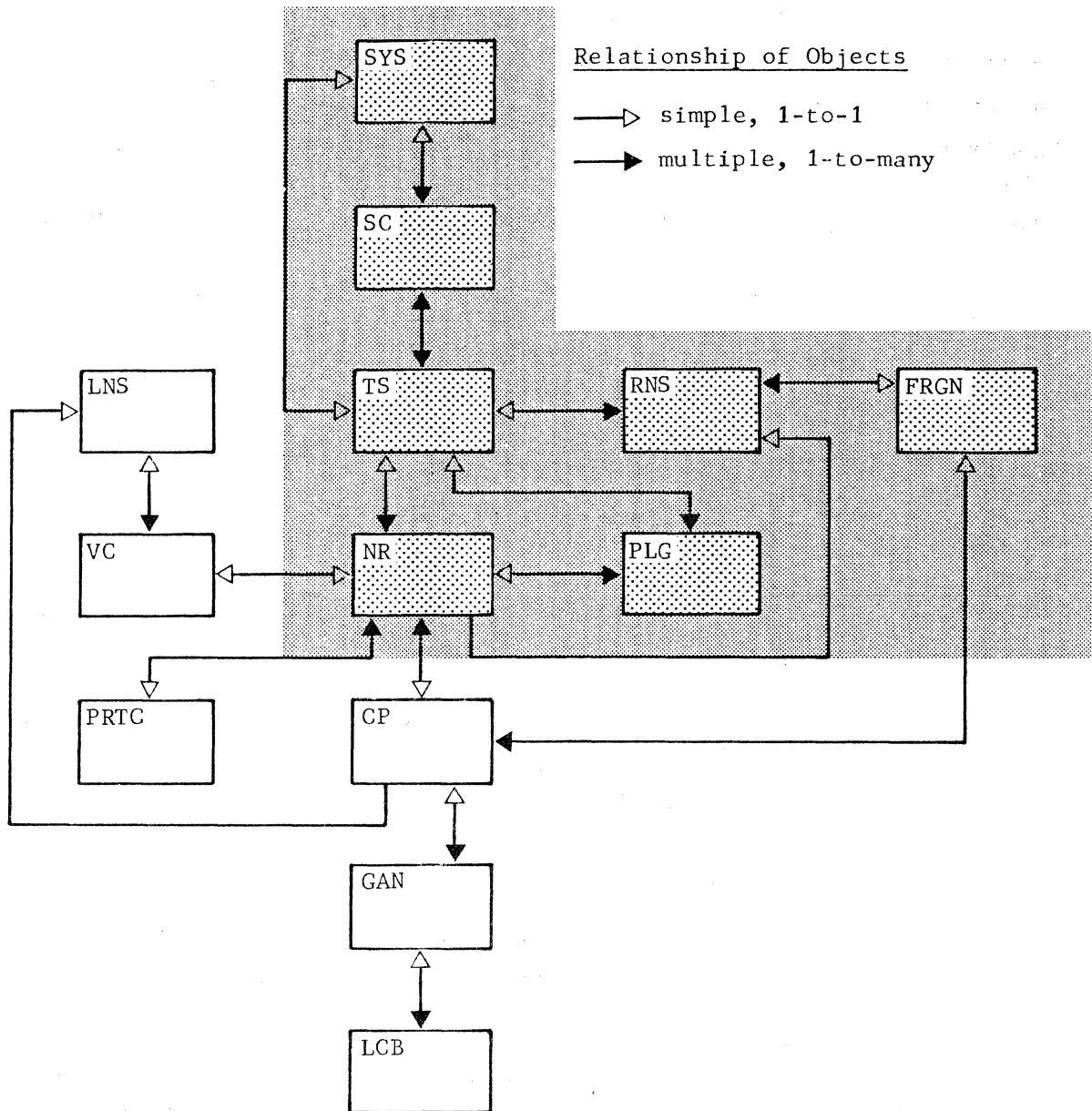

The objects in the transport layer include those in the session layer and are generated by the following CNC commands or their internal parameters

- SYS (LSYS or RSYS)
- SC (LSC or RSC)
- TS (LTS or RTS)
 - NR (NR)
 - RNS } (ADDR_{RTS})
 - FRGN }
 - PLG (XCNT_{RTS} or MUXPRM_{LSUB}).

All call numbers related to the "foreign network" are chained to its FRGN.

Mapping Network Objects

The network layer is optional. However, when it is present, it provides the means to switch the packet through a network route.

The types of network routes, as shown on the facing page, are

1) Two network routes are each mapped over different point-to-point HDLC lines.

This is an example of two "remote systems" that can be connected to each other through a number of network routes.

2, 3 and 4 are examples of several network routes sharing the same communications path.

2) System A connects to system B over 1 network route while B can connect to A over either of its 2 network routes.

3) 2 network routes from system B are mapped over 2 different virtual circuits, both of which share the same HDLC line over the packet switching network to access system A.

4) Network routes from system A are mapped to systems B and C over a single point-to-point HDLC line.

The network service involved in an exchange with an rts, can be regarded as having two functions

- . firstly, addressing the system for the purpose of routing an access to it
- . and secondly, selecting the network route for the purpose of conveying the packet.

DSA provides for two routing techniques dependent on the type of packet, namely

- . the datagram which, being a discrete packet, is an independent entity from other packets and must contain within itself all the service information concerning routing and controlling its transfer
- . and, the non-datagram which, being a linked packet, is one in a sequence of packets for which only the first packet contains complete service information concerning the routing and controlling the transfer of the entire packet sequence.

Datagrams can be transmitted over as many different network routes as are available even if the datagram is logically either the result of a preceding datagram or the prompt to a succeeding datagram.

Non-datagram data is transmitted over a network route fixed for the duration of the entire transmission, the intermediate switcher machine having no choice of selection once the network route is established.

The network route can be mapped over

- . either a point-to-point HDLC line
- . or a virtual circuit if the communications path accesses a packet switching network, like TRANSPAC.

Transport connections can be multiplexed over the virtual circuit. Multiplexing protocol is part of transport protocol to establish the transport connection each time that the session requests it. Multiplexing allows several transport connections over the same virtual circuit.

The network protocol sets up the virtual circuit and, where multiplexing occurs, clears down the virtual circuit when the last transport connection has terminated.

Types of Network Routes

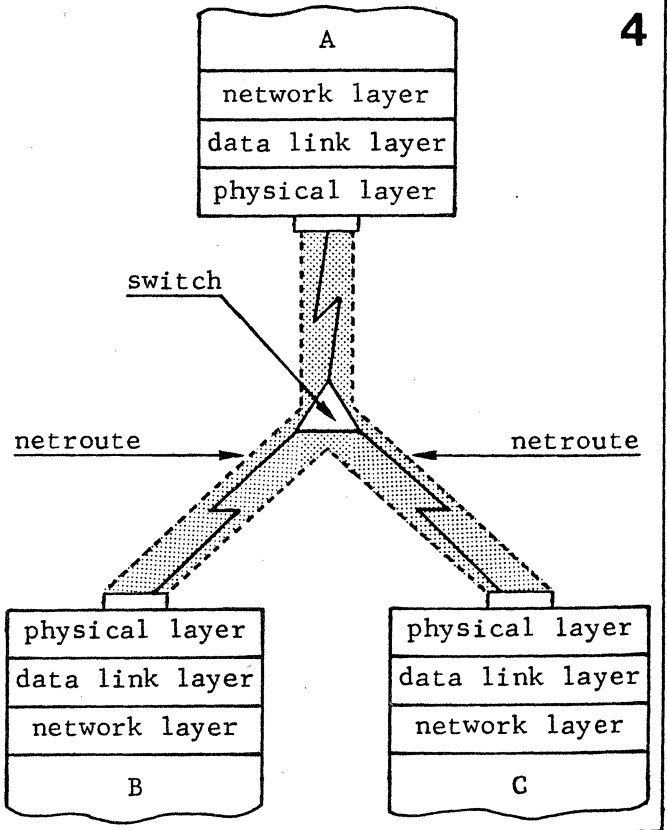
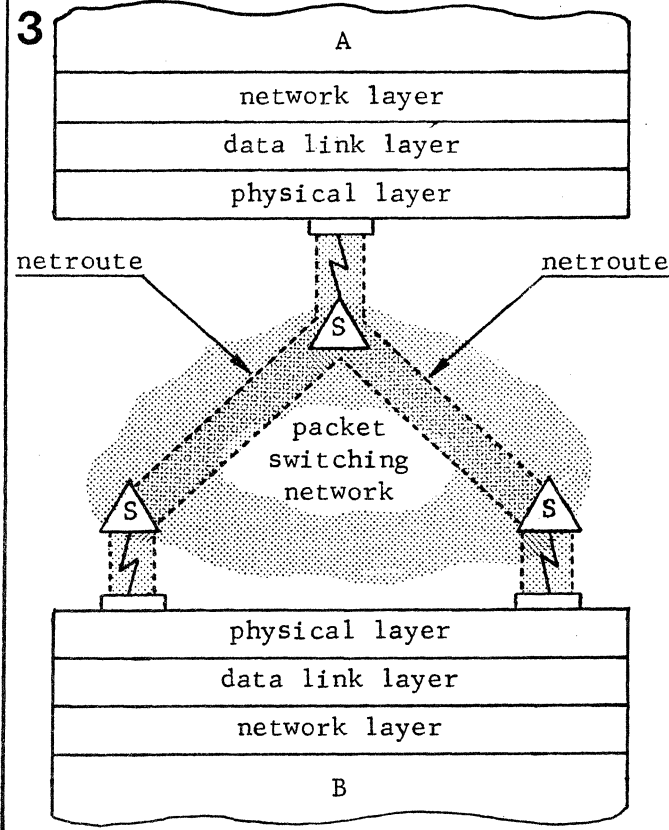
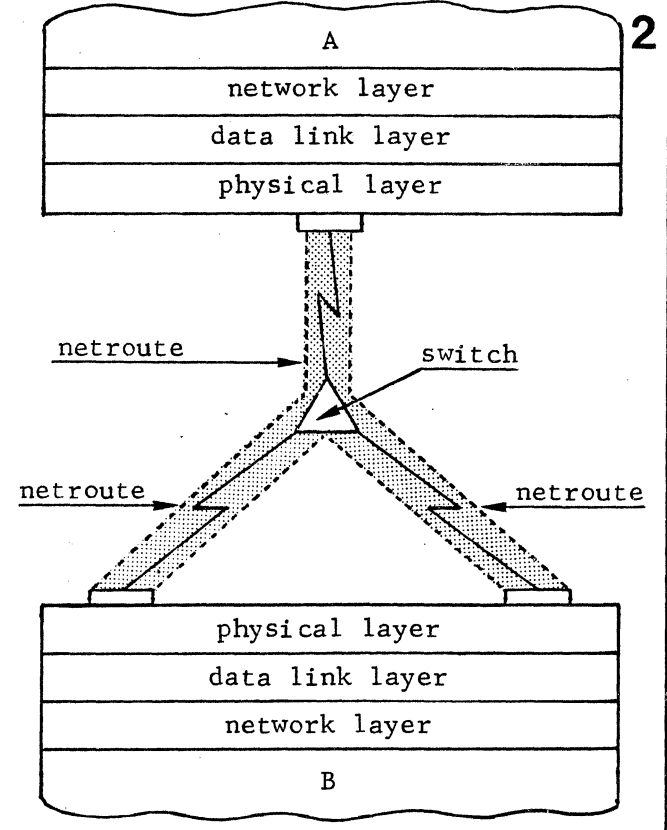
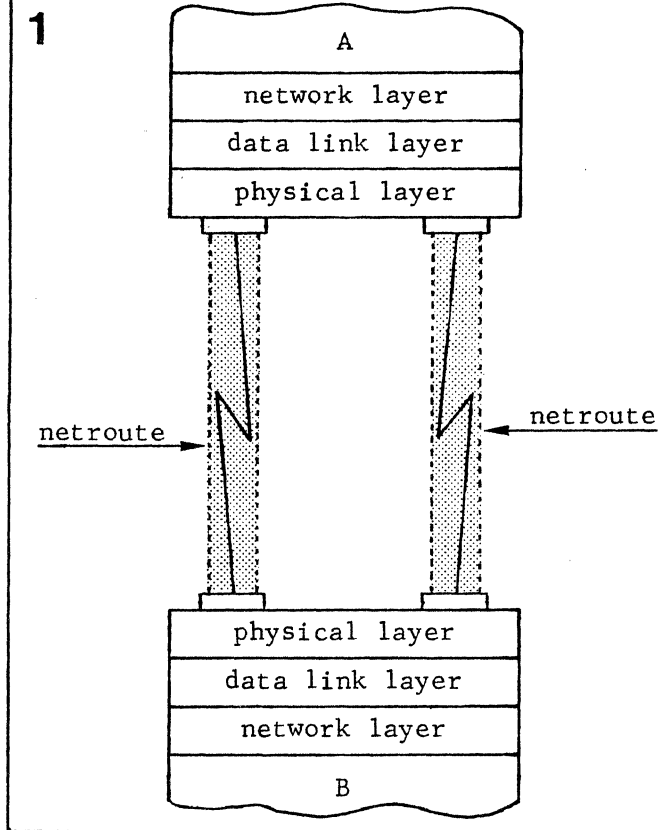

In the third and final stage of connecting the application to the user accessing it, transport connections between several correspondents can be multiplexed over a single virtual circuit.

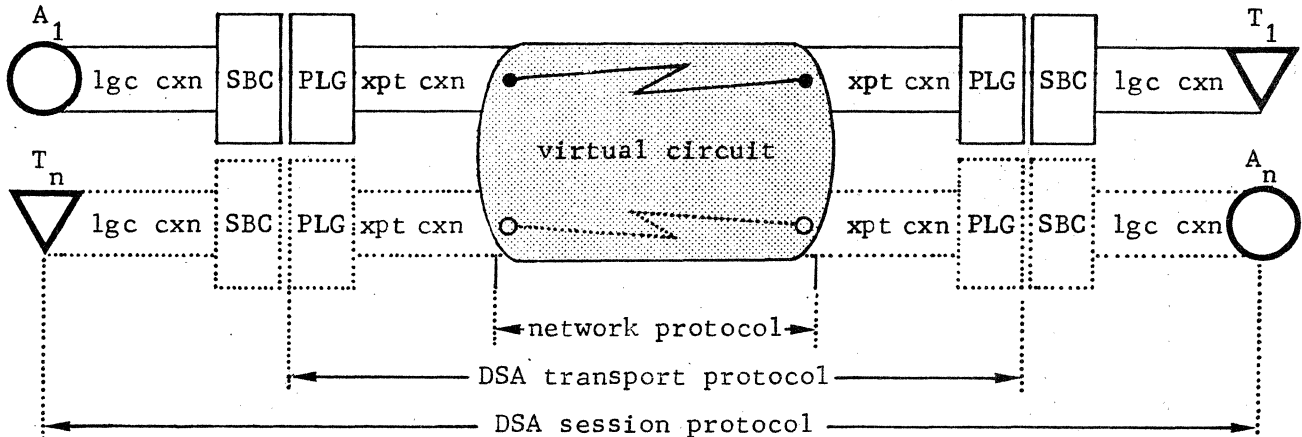

The network route is "concatenated" to its associated rts through its name being specified as the argument of the NR parameter in the preceding RTS command. If more than one network route is to serve a given rts, the list of nr's must appear in the NR parameter of the relevant RTS command, followed by as many NR commands.

The NR is always mapped over a communications path. If the CP is an access to an X25 packet switching network, like TRANSPAC, then the NR is always associated with a virtual circuit.

To establish the VC, there must be

- . a local subscription number (LNS) for the "local system" to "enter" the network
- . and, a remote subscription number (RNS) to "exit" from the network to access the "remote system".

Both LNS and RNS are decimal numbers.

The lns must be specified as the argument of the SUBNB parameter of the LSUB command. The name referencing the lns must be

- . declared in the LSUB command
- . and, specified as the argument of the SUBSCRID parameter in the CP command.

The rns is specified as the argument of the ADDR parameter in the preceding RTS command. If more than one rns is to serve a given rts, the list of rns's must appear in the ADDR parameter of the relevant RTS command. Since TRANSPAC is a foreign network (FRGN), all rns's are mapped on to it.

Transport protocol parameters, like the options described on page 1-05, are associated with the network route and are stored in a table (PRTC). The PRTC is built from parameters specified in the XPRTC command. These parametric values are used to negotiate a connection with the appropriate rts.

Mapping Network Objects

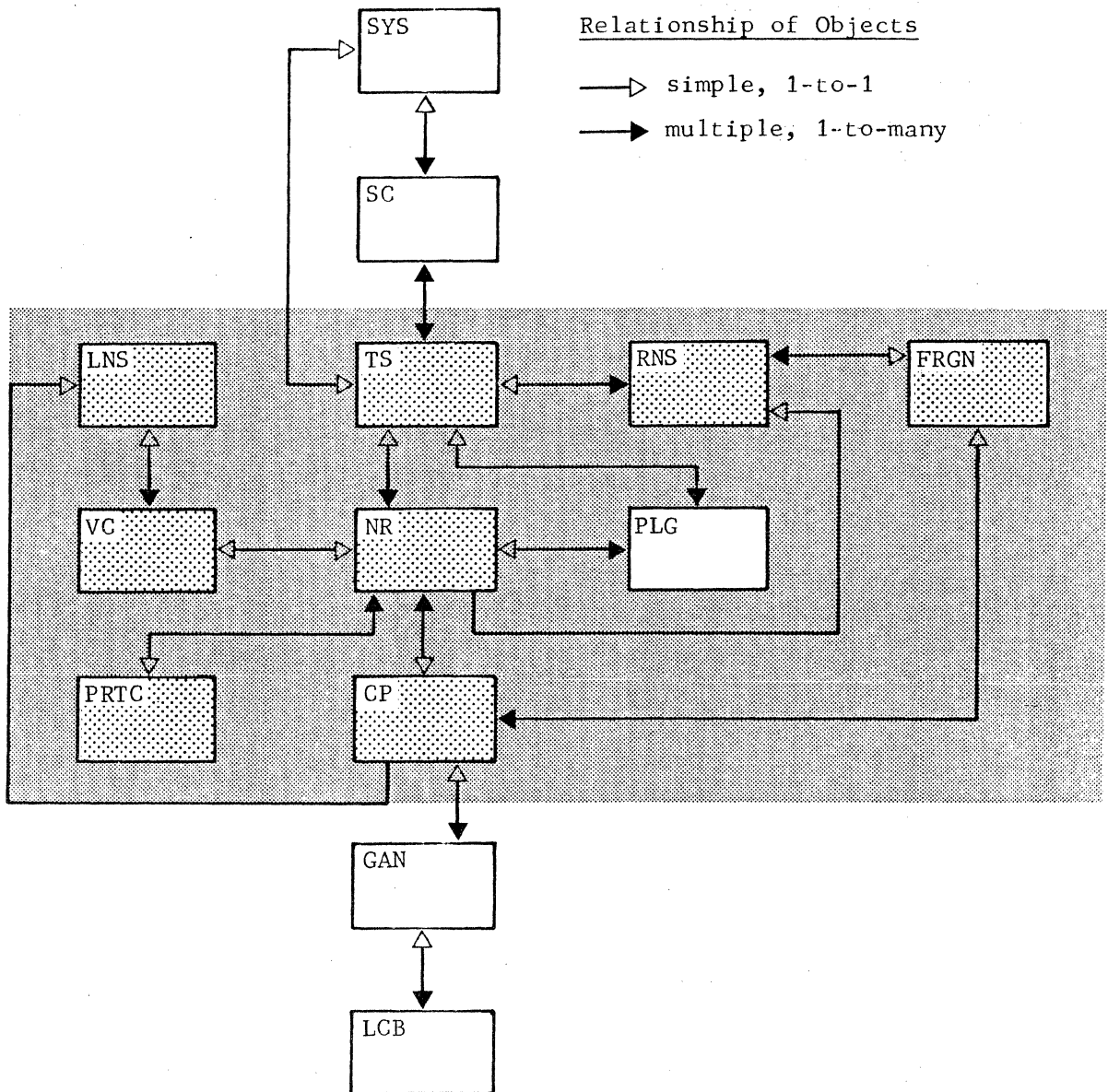

The objects in the network layer are those which are necessary to establish the "access path", and are generated by the following CNC commands or their internal parameters

- TS (LTS or RTS)
 - RNS
 - FRGN } (ADDR_{RTS})
- NR (NR)
 - VC (LSUB parameters : SILIN / SLINE / SOLIN)
 - PRTC (XPRTC)
- CP (CP)
 - LNS (LSUB)

Mapping Data Link Objects

Data link protocol governs the physical exchanges over link paths. The link paths are established for

- . virtual circuits of the switched public data network, like TRANSPAC, which support
 - the primary network interconnecting systems
 - and, the secondary network involving the system, on one side, accessing its terminals across such a network, on the other side
- . and, point-to-point leased lines joining up systems in a primary network.

The term "point-to-point" in the context of the leased line refers to the direct access between a system at one point and another system at the other point.

The protocol used for the link path is point-to-point HDLC (High-level Data Link Control). The term "point-to-point" in the context of HDLC is as opposed to "multipoint" for which polling is available.

The packet is placed into frames for retransmission by HDLC as a bit stream along the physical link.

The communications path is "concatenated" to its associated network route through its name being specified as the argument of the CP parameter in the preceding NR command.

The cp which is the principal data link object is related to the nr according to the link path over which the nr is mapped, namely

- . if a virtual circuit of the same local subscription number (LNS), several nr's can share the same cp
- . or, if a point-to-point leased line, there can be only one cp to the nr.

The point-to-point leased line is specified as the argument of the ACCESS parameter of the CP command.

Objects defining the data link itself are the general access network table (GAN) and the line control block (LCB). Both these objects are created each time an HDLC line appears in the CNC description.

The GAN heads the output physical queue(s) and is associated with at least one cp. Several cp's can use the same GAN. The GAN determines which data stacked in the queue(s) is to be despatched to what destinations.

The LCB is used by one or several GANs and controls the data transfer along the physical link.

Mapping Data Link Objects

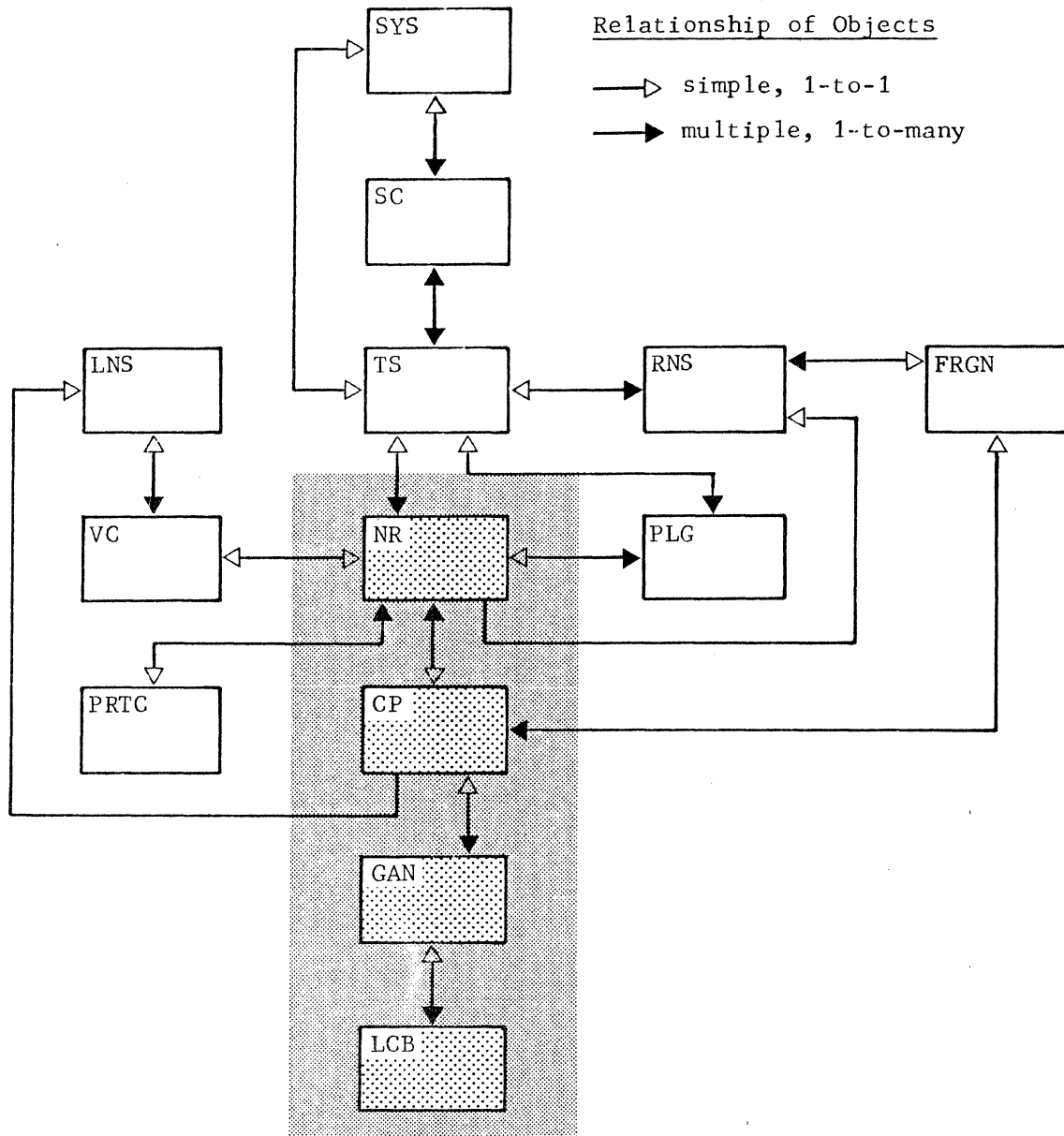

The objects in the data link layer are either generated by, or the result of, the following CNC commands

- NR (NR)
- CP (CP)
 - GAN (LINE_{hdlc}), 1 gan per hdlc line
 - LCB (LINE_{hdlc}), 1 lcb per hdlc line.

The CP object is the common relational object whether the link is either "mono" or "multi".

MAPPING DSA ELEMENTS ON GCOS COMMUNICATIONS COMPONENTS

These DSA elements are those other than objects of the primary network and which can either be mapped on to physical elements of the network or be associated with conceptual functions known to GCOS.

Whereas mailboxes and workstations are physical elements, the logical connection and the session are not.

The diagram on the facing page shows a schematic relationship of the elements. The term "correspondent" refers to both the application and the terminal, representing the user. The term "transport connection" refers to the communication with a remote mailbox in which the correspondent is

- . either a terminal in the secondary network accessed over a primary network such as TRANSPAC
- . or an application in a remote system accessed over the primary network.

In the case of the URP connection, the DPS 7 assures the transport, whereas in the case of the DN7100 connection, it is the DN7100, not the DPS 7, which assures the transport. See page 1-07.

In a typical DPS 7 installation, the most likely communications services in use are

- . IOF whose monitor handles user connections to interactive applications
- . TDS whose executive supervises simultaneous transactional processes
- . MCS, composed of QMON and MAM, which provides the control interface for user communications applications
- . and, NASF whose file server provides data support for ADM when servicing the DN7100.

The logical connection between NASF and ADM is established through their respective mailboxes. This connection is a mono-logical connection and, for simplicity, is shown with the same symbol as the "terminal mailbox".

Mapping DSA Elements
on
GCOS Communications Components

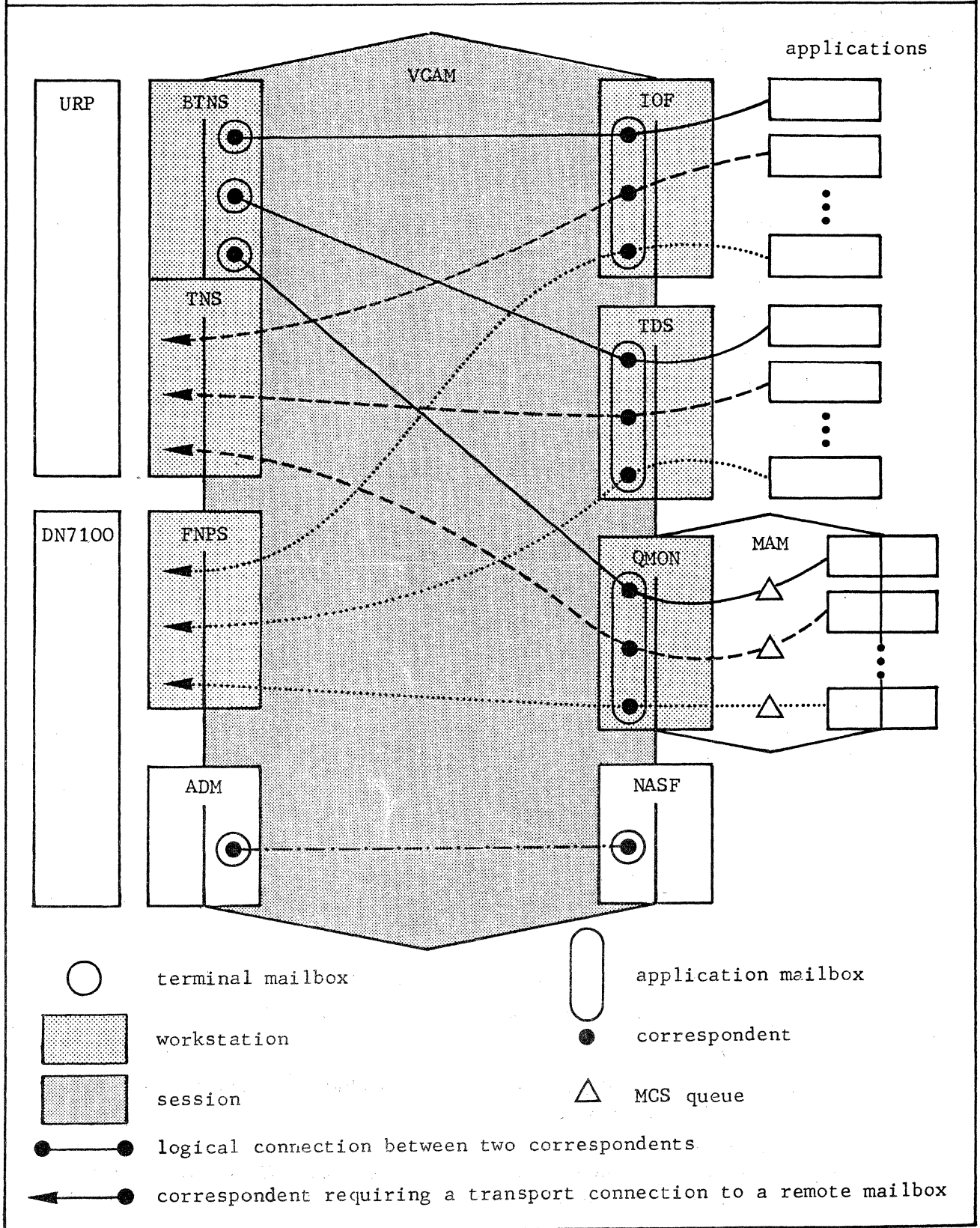

Mailboxes

A mailbox is the addressable point-of-entry providing access to correspondents of the network.

Within the same system, the name of the mailbox need only be unique at session level. However, throughout the network, in order for mailboxes of different systems to be unique, they must be addressed in the format <session-name>.<mailbox-name>.

TERMINAL MAILBOX

Terminal mailboxes known to GCOS and managed by GCOS, apply to terminals in the URP local network and the TRANSPAC/URP secondary network.

There is one mailbox per terminal which is identified by the same name as declared in the appropriate CNC command at network generation

- . TERMNL command for a terminal in the URP local network
- . and, RDTN command for a terminal in the TRANSPAC/URP secondary network.

The RDTN command is preceded by an RDTE command which describes the type of equipment and the mode of management of the virtual circuit between the correspondents.

APPLICATION MAILBOX

Application mailboxes provide access to GCOS communications services, see pages 2-06 through 2-08.

Unlike the terminal mailbox, the application mailbox handles several correspondents, see "Logical Connection".

All communications services handle one mailbox each for all users connected to it, specific cases being the following

- . TDS : Each version of TDS handles up to 2 mailboxes, the second mailbox being optional for the master terminal
- . MCS : For each MCS application, every queue declared corresponds to one mailbox and is handled by QMON
- . TILS : The number of mailboxes depends on the communications session to be simulated
 - for an IOF session, only one mailbox need be declared
 - for a TDS session, more than one mailbox can be declared, up to a useful maximum of "spawned" terminals.

The naming of application mailboxes is as follows

- . IOF and RBF6/FTF6 take the same mailbox names, IOF and RBF, respectively
- . DJP/DFT and CARDLESS are known to GCOS as FILTRAN and READER, respectively
- . OLTD takes the name TD
- . MCS application mailboxes take their names from their corresponding QUEUE commands declared at CNC generation
- . NASF uses two mailboxes, namely
 - the \$LOGFILE mailbox for receiving AEP records from NADs of other DSA systems
 - and, the \$NASF mailbox for exchanging files between administrative correspondents.

- . TDS : for each version, up to 2 mailboxes can be declared in the TDS SECTION of the TDS generation program
 - the mandatory user mailbox takes the name defined as the argument of PROGRAM-ID
 - and, the optional master terminal mailbox is defined as the predicate of the clause MASTER MAILBOX IS <master-name>
- . TILS defines its mailboxes in its declaration file
 - the mandatory user mailbox is declared in NAME, the default being TILS
 - and, all other optional mailboxes are defined in as many PATHs.

ADMINISTRATIVE MAILBOX

Administrative mailboxes provide access to communications management components. These mailboxes are intended for use by the system for administration and control. The names of the administrative mailboxes for ADM, NASF and DSAC, are

- . ADM_MBX for ADM (this mailbox is internal)
- . \$NASF for the ASF function of NASF
- . \$LOGFILE for the AF DSALOG function of DSAC (ASF log function)
- . and, \$NAD for the AF LNAD function of DSAC.

Workstations

A workstation represents a service or a collection of mailboxes. Unlike the mailbox, the workstation is not a directly addressable entity.

The name of the workstation is used in communications service commands

- . to make available the corresponding service to other system components
- . and, to modify the parameters of the mailboxes pertaining to it.

Communications services, by their distributed nature, function both as application mailboxes as well as service workstations. These are therefore treated here although these services are not communications management components.

BTNS WORKSTATION

The BTNS workstation takes its name from the GENCOM command at CNC generation.

Its name is used

- . optionally, to start BTNS
- . and, to provide the userid of terminals declared with the AUTO option, of the format <gencom-name><terminal-name> or <lsys-name><terminal-name>.

The "terminal manager" corresponds to the set of terminal-mailboxes and is mapped on to the BTNS workstation.

The main administrative functions of the BTNS workstation that are available to the user, are executed through the following network control commands

- . RT and HT : for modifying the number of active terminal-mailboxes
- . MTL, MTP and MTT : for modifying the operability of the line and terminal
- . and, TT : for shutdown.

The functions of BTNS are described on page 2-10.

TNS WORKSTATION

The TNS workstation functions with the BTNS service. It is an internal transport workstation known to GCOS as DSA_TS.

It groups application-mailboxes of the system within the primary network.

The TNS workstation is activated when

- . BTNS is started up
- . and, the first HDLC line is activated.

TNS is deactivated when the last HDLC line is deactivated. For the communications session, TNS terminates when BTNS shuts down.

The only administrative functions of the TNS workstation that are available to the user, are executed through the RT and HT network control commands

- . for tuning, by starting up the "injector" facility for simulating the session layer between 2 transport stations, and for generating data traffic
- . and, for maintenance, by providing a complementary trace for the TNS domains and their associated subdomains.

The functions of TNS are described on pages 2-10 and 2-11.

FNPS WORKSTATION

The FNPS workstation defines the "transport" over the FNPS/DN7100 interface. This "transport" or FNPS workstation takes its name from the FNP command, declared at CNC generation, which

- . describes the operation of the FNPS service
- . and, maps the DN7100 "front-end" system over the PSI of the DPS 7 "host".

Up to 6 FNPS workstations can be configured on a DPS 7 installation, each of which corresponds to a separate occurrence of the FNPS service for the associated DN7100, however, only 4 FNPS workstations can be simultaneously active.

Whereas the name of the FNPS workstation is used to identify the appropriate FNPS service to be started up or shut down, the name of the DN7100 "session-control" is used to "enable" or "lock" the appropriate PSI of a bi-PSI DN7100.

The only administrative functions of the FNPS workstation that are available to the user, are executed through the following network control commands

- . MTF : - for tuning, by stopping and starting up the "watchdog" status exchanges between the workstation and the DN7100
 - and, for maintenance, by providing the trace over the FNPS/DN7100 interface
- . and, TT : for shutdown.

The functions of FNPS are described on page 2-11.

SERVICE WORKSTATION

The service workstation corresponds to the application mailbox or a set of application mailboxes associated with the communications service. Service workstations derive their names from their corresponding application-mailboxes.

For IOF, RBF6/FTF6 and DJP/DFT, the names of, and the external administrative functions for, these workstations are not visible to the user because these services are automatically started up when either BTNS, TNS or FNPS are started up. ★

TDS, MCS applications, TILS and OLTD must be started up as job steps after either BTNS or FNPS have been started up. In the JCL subfiles for starting these services, the JOB statement can take any user-defined name, whereas the STEP statement must bear the following respective names of the load-module

- . TDS : STEP <tds-name>, where tds-name is the argument of PROGRAM-ID of the TDS SECTION of the generation program
- . MCS : STEP <load-module-name>, where lm-name identifies either a monprocess or multiprocess load-module
- . and, TILS : STEP H_TILS, indicating that the TILS service is required to be run.

The JCL subfile for OLTD is internal to GCOS and the names of the 2 consecutive steps, H_TD1 and H_TD2, are not visible to the user. The name of the OLTD service is known to GCOS as TD, and a test is launched by an "SJ TD <parameters>" operator command.

TDS Workstation

The TDS workstation comprises two application-mailboxes. The workstation is activated when the associated TDS job step is started.

If a master terminal has been declared, commands addressable to the TDS workstation concerning its startup and shutdown, M START and M STOP respectively, can now be entered at the designated terminal and executed. In the absence of the master terminal, these commands are entered at the system console.

QMON Workstation

The QMON workstation is a group-set of all application-mailboxes corresponding one-for-one with their respective MCS queues.

The term "MCS queue" refers to the queue used by the MCS application to serve one of the following functions

- . a BTNS terminal-queue to serve a terminal in either the URP local network or the TRANSPAC/URP secondary network
- . a DSA-queue, see "Session"
- . or, a program-queue for MCS applications to receive messages.

The QMON workstation is known to GCOS as QMON and is activated after either BTNS or FNPS have been started up by the "ST QMON" network control command. QMON as a service has a mailbox known to GCOS as QMONMBX.

QMONMBX is involved in the logical connection with the terminal-mailbox under the following conditions

- . at connection time if the associated terminal-queue is "enabled" and contains data to be output to
 - either an "automatic" terminal
 - or a terminal for which neither an application has been specified nor a default application exists for the project
- . when a terminal A, say, logs on to the terminal-queue of another terminal B, say, which is already "logged", so that messages entered at A are transmitted to B
- . and, for a connection between an application and a terminal, if no \$QASSIGN IN has been declared for the program-queue.

For further details, see "Connection Handling", MCS User Guide.

The external administrative functions of MCS are not visible to the user under the following conditions

- . if the logical connection does not involve the terminal-mailbox, in which case QMON is not required
- . and, if the MCS application is declared "automatic", in which case operator intervention is not required.

The facility for declaring an MCS application "automatic" is indicated at network generation by both of the following CNC options

- . the INIT parameter of the QUEUE command specifying the name of the application
- . and, the APPLIB parameter of the GENQMON command specifying the cataloged library of application JCL subfiles, of which the referenced application is a member.

Logical Connection

The logical connection is the means whereby a message-path is set up between two correspondents. The terminal mailbox handles one correspondent and is a mono-logical connection, whereas the application mailbox handles several correspondents and is a multi-logical connection.

At connection time, tables representing the correspondents and their management parameters are accessed by VCAM. If the connection request is successful, VCAM dynamically generates parametric values for these tables, namely

- . to number the logical connection to match the internal VCAM logical connection table in order to establish the corresponding parameters to be negotiated for the connection
- . and, to return to the application, the session control identifier to be used for all exchanges over the connection.

Session

The session is associated with a server. The session server is the automaton in the session layer which implements session protocol.

The session is addressable in the DSA network through

- . its session name which is a unique global external name and is alphanumeric
- . and, its session control identifier which is a unique internal network address composed of two decimal integers.

Refer to "Mapping Session Objects", pages 1-12 and 1-13.

The session layer resides in all DSA systems, "local", "front-end" and "remote". In order to locate a mailbox in any of the systems other than the local system, the DSA address of the format <session-name>.<mailbox-name> is used to identify the QUEUE command at network generation, so that identification is unique.

Such a mailbox identifies a DSA-queue which, when used to send messages, can be

- . either a terminal connected to a "front-end" or "remote" DN7100
- . or an MCS application in a "remote" DPS 7.

SECTION II

GCOS SUPPORT OF NETWORKS

Communications supported by the DPS 7 depends on

- . the hardware connected to its PSI (peripheral subsystem interface), being either the integrated URP of the DPS 7 or the DN7100 "front-ending" the DPS 7
- . and, the physical link established over either the URP or the DN7100
 - between the DPS 7 and another "remote system" in a primary network
 - and, between the DPS 7 and its terminals in a secondary network.

From now on, TRANSPAC will be referred to as the example of an X25 packet switching network.

Primary networks can be established over TRANSPAC switched virtual circuits or connected over point-to-point leased lines.

Secondary networks comprise terminals connected to the DPS 7 in

- . local networks, whereby terminals are accessed directly, that is, through point-to-point leased lines or over lines of the telephone and telex networks
- . and, TRANSPAC secondary networks whereby terminals are accessed over switched virtual circuits.

TYPES OF NETWORKS

The types of networks schematically shown on the facing page are

- . the primary network, composed of the systems A, B ("front-ended" by E), C and D, connected as follows
 - A connects to C directly through its URP over a point-to-point line and a TRANSPAC switched virtual circuit
 - whereas, B connects to A and D through the intermediary of E, its front-end system,
 - . over TRANSPAC switched virtual circuits
 - . and, in the case of B and D, also over a point-to-point line.
- . and, secondary networks, involving the groups of terminals, AL and AS, and, EL and ES, connected to their respective "local systems" as follows
 - AL and AS connect to A directly through its URP, A being therefore their "local system", to form the URP local network and the TRANSPAC/URP secondary network, respectively
 - and, EL and ES connect directly to E but only indirectly to B, E being therefore their "local system" and not B, to form the DN7100 local network and the TRANSPAC/DN7100 secondary network, respectively.

In the examples of A and B, as DPS 7 "local systems"

- . A, through its URP, is configured to both the primary and secondary networks
- . while, B, by being "front-ended" by E, is only configured to the primary network but not to secondary networks; instead the secondary networks shown are configured to its "front-end system" E and the terminals have indirect access to B.

Types of Networks
configured to the
DPS7 "local system"

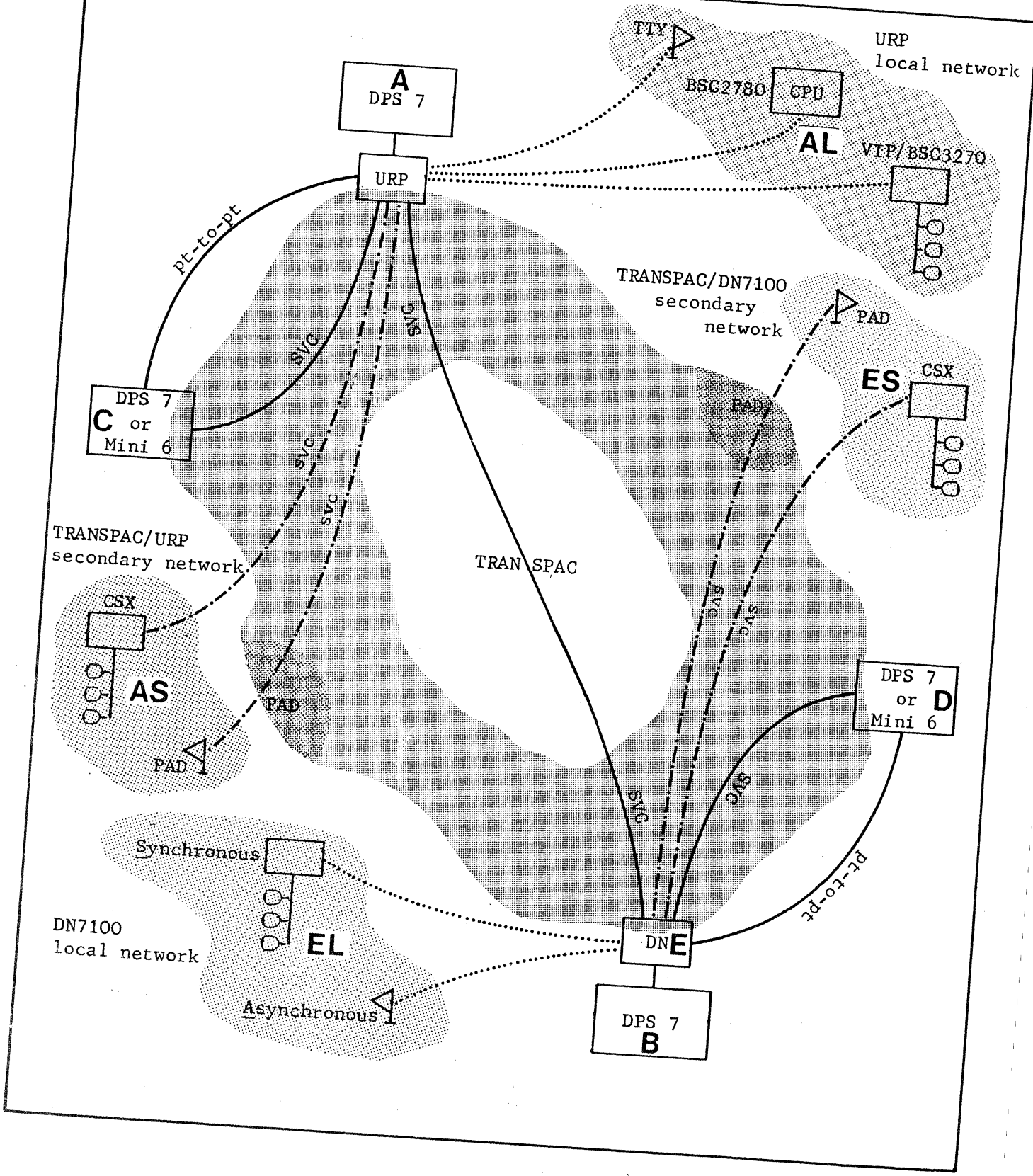

COMMUNICATIONS COMPONENTS

GCOS communications software is structured around three principal DSA layers to provide the support of the different types of networks described, as follows

- . the application layer occupied by the communications services being
 - RBF6/FTF6, Remote Batch Facility/File Transfer Facility from/to the Mini 6
 - DJP/DRB, Distributed Job Processing/DSA File Transfer facility between DPS 7s
 - IOF including the "pass-through" function operating under IOF
 - TDS, Transaction Driven Subsystem
 - CARDLESS, also known to GCOS as READER, for DPS 7 installations using diskette
 - TILS, Transactional and Interactive Load Simulator
 - OLTD, On-Line Tests and Diagnostics
 - MCS, Message Control System composed of MAM and QMON
 - NASF, for DN7100 service functions and DSA logging
- . the session layer occupied by VCAM which provides the message management by
 - handling connection and dialog functions
 - and, allowing direct access to terminals and applications without their being aware of the communications path or mechanism for establishing their connection
- . the transport layer occupied by the following modules for providing the communications management according to the PSI connection, namely
 - for the URP
 - . BTNS for managing terminals in the URP local network
 - . and, TNS, a function of BTNS/HDLC
 - for enabling the DPS 7 to connect directly to the primary network
 - and, for managing terminals in the TRANSPAC/URP secondary network
 - for the DN7100
 - . FNPS for enabling the DPS 7 to interface at transport level with the DN7100 thereby allowing the DPS 7 to connect "indirectly" to the primary network
 - Note : Terminal management in the DN7100 local network and the TRANSPAC/DN7100 secondary network is a function internal to DNS software and is not visible to GCOS. Terminals connected in both these networks are not declared in the CNC description of the DPS 7 "local system".
 - However, "remote systems" connected to the DPS 7 via the DN7100 must be declared together with their associated FNPS services in the CNC description.
 - . ADM/NASF (ADM file server) for executing service functions on a given DN7100 and is therefore mutually exclusive to the occurrence of its associated FNPS service.

GCOS support for networks concerns primarily the network management component of communications software, being VCAM operating in conjunction with any of BTNS, TNS and FNPS.

Schematic Interfaces
of DPS 7
Communications Components

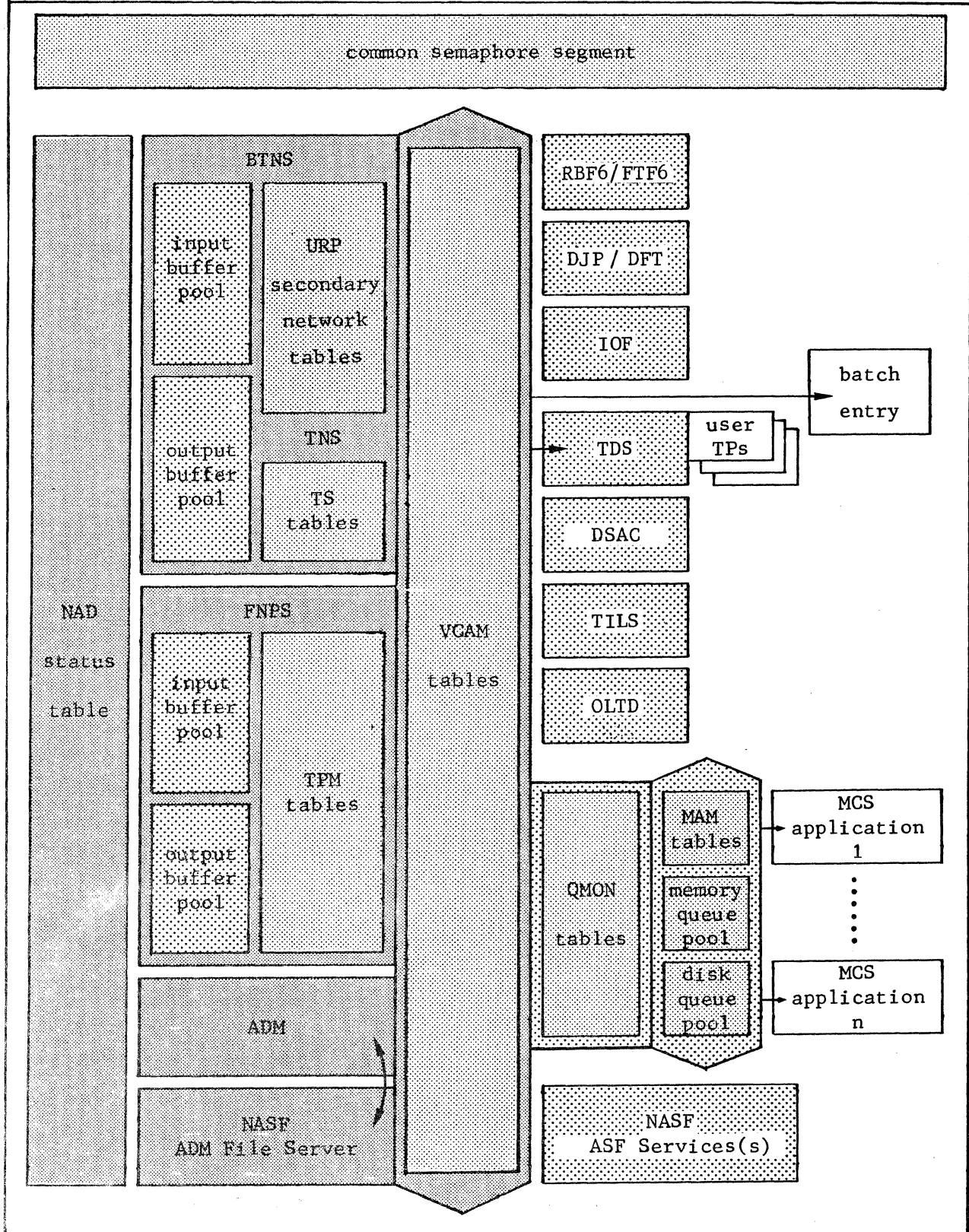

Communications Services

Communications services are applications which are

- . either "packaged" products supplied by BULL Systèmes such as IOF
- . or communications software which are needed by user-defined applications to interface with VCAM such as TDS and MCS.

RBF6/FTF6

RBF6 and FTF6 are two services in the DPS 7 that enable it to link up with the Mini 6. Homologous services in the Mini 6 are N_RBF7 and N_FTF7.

The term RBF refers to the functions provided by RBF6 in the DPS 7 and N_RBF7 in the Mini 6, and allows the Mini 6 station operator

- . to submit a "remote" job to the DPS 7 for execution
- . and, to receive the JOR and SYSOUT listings of the job submitted.

The term FTF refers to the functions provided by FTF6 in the DPS 7 and N_FTF7 in the Mini 6, and allows the transfer of files in both directions. Both the Mini 6 station operator and the DPS 7 system operator can

- . transfer files in either direction of the recipient systems
- . and, control and monitor this transfer.

DJP/DFT

DJP and DFT are two services that enable the DPS 7 to link up with another DPS 7.

Both these services are available to any IOF user logged on to the participating DPS 7. Job submission (DJP) and file transfer (DFT) are symmetrical between the two DPS 7s since these activities can occur in either direction.

The file containing the job to be submitted need not necessarily be in the same location as the machine executing the job. The keywords SITE and HOST are used to indicate the location of the file and the location of the executing machine, respectively.

The transfer of file contents is requested at either DPS 7. During the transfer, the operation can be controlled and monitored at both the DPS 7s.

IOF

IOF is an interactive service which provides the user with such tools as

- . creating, updating and deleting source files or subfiles containing data, language instructions, processor commands or GCL statements
- . launching and controlling batch jobs, MCS applications or other communications services such as TDS, from any general-purpose terminal
- . scanning and receiving output reports from jobs submitted
- . and, executing interactively any application, utility or processor.

TDS

TDS is an executive for initiating, scheduling and monitoring transactions executable in the form of transaction processing routines (TPR).

The executive is parametrized at TDS generation to the requirements of the user, while the TPRs which are user-defined, are written in COBOL and RPG.

A generated version of TDS with its associated TPRs is started as a job step

- providing the interface for connections and disconnections, and data exchanges between the TPRs and VCAM
- dispatching messages across TPRs according to the contents and context of the message, for example, the arrival of a message for a TPR which is not the first TPR of the transaction
- maintaining "before" and "after" journals for data security
- protecting updates and movements of data in the IDS "data base" through GAC
- and, restarting after an abort or system crash.

DSAC

DSAC provides the services which enable the DPS 7 to administrate and control its networking environment.

It allows the exchange of control information between participants of the network, and, the journalization of events occurring throughout the network.

Detailed information on DSAC is treated in Section V.

TILS

TILS simulates a "workload" for IOF and TDS executing on either the same system or another system connected over the DSA network.

Since interactive and transactional applications have dynamic resource requirements, TILS enables the DPS 7 user to gauge the effect of such demands on the performance of the system before extending the work capacity of either or both applications.

The results obtained from TILS must be interpreted with the results obtained from the System Behavior Reporter (SBR) which gives the overall performance of the DPS 7 as it currently stands.

OLTD

OLTD is a "maintenance" service providing a set of verification, confidence and diagnostic tests that can be called interactively by users of the DPS 7.

The purpose of executing these tests is to provide preliminary symptoms at different levels of any suspected anomaly in the system. These symptoms can then be transmitted to the Service Center for an initial assessment of the most likely cause and best remedy of the anomaly before the engineer arrives.

The advantage is therefore to minimize the time taken to locate the anomaly and to reduce the "down" time of the affected component.

MCS

MCS provides access to user-defined queues. Its functions are provided by MAM (Message Access Method) and QMON (Queue Monitor).

MAM is a set of queue control procedures contained in the H_{SM2} member of the sharable module library. QMON is a separate load module which interfaces VCAM session control procedures with MAM queue control procedures.

MCS applications use queues to input and output data. These applications are written in MCS COBOL and GPL.

MCS applications can be executed once QMON is started up as a job step.

The functions provided by MCS are

- . managing queues of messages in memory and on disk files
- . recovering disk queues after an
- . synchronizing and maintaining communication between MCS applications within the same DPS 7 system
- . initializing and formatting disk queue files.

NASF

NASF has two functions, namely

- . as the file server to ADM, it provides service functions on the DN7100, see page 2-11
- . and, as ASF proper, it is automatically enabled as soon as a primary link is established in the network, independently of the connection type, that is, either through the URP or the DN7100, thereby allowing the DPS 7 to receive incoming administrative sessions from correspondents of the primary network on the \$NASF mailbox.

★ As ADM file server, NASF

- . either retrieves data from its files to input to ADM for generating DNS software and, subsequently for loading the DN7100
- . or stores the memory image of the DN7100 when a dump is required.

USER DEFINED APPLICATIONS

User-defined applications are either transaction processing routines (TPRs) or MCS applications.

TPRs, written in COBOL and RPG, are compiled and linked separately. On execution of a TDS generation, the TPRs specified are dynamically linked to the TDS executive into private sharable modules. The advantage of this dynamic linking is that when a TPR is modified, the TDS load module need not be regenerated.

MCS applications, written in MCS COBOL and GPL, are either monoprocess or multiprocess load modules. They communicate with terminals, and other remote or local MCS applications, through queues specified by the user and managed by MCS.

Message Management

VCAM is a set of session control procedures contained in the H_SM1 and H_SM2 members of the sharable module library.

It provides GCOS communications services a unique "direct access" common interface to users and applications throughout the network.

The functions provided by VCAM are

- . handling the DSA connection and session protocols
- . centralized management of security checks related to the connection protocol
- . centralized management of dynamic DSA entities such as workstations, systems, mailboxes, logical connections and message-groups within GCOS
- . and, providing the internal means of communication between a communications service such as TDS, and a batch entry program, in the same DPS 7.

Communications Management

Whereas VCAM provides a common message management interface for all sessions, communications management is composed of three separate modules according to the type of network and the hardware connected over the PSI of the DPS 7.

These modules are

- . BTNS for the URP local network
 - . TNS, a function of BTNS/HDLC, for the TRANSPAC/URP secondary network and the primary network
- Both BTNS and TNS function through the integrated URP of the DPS 7
- . and, FNPS for the TRANSPAC/DN7100 secondary network and the primary network accessed through the DN7100 functioning as the "front-end" system for the DPS 7.

BTNS

BTNS handles terminals connected over switched and leased lines of the URP local network. It is started up as a job step by the ST system console command.

The functions of BTNS are implemented by SNC (Secondary Network Controller) and LM (Line Monitor).

BTNS performs the following functions

- . initializes URP communications firmware
- . polls multidrop lines and manages terminals
- . handles data exchanges and recovers errors in transmission
- . manages buffer pools
- . analyzes and executes network control commands
- . manages the local dialog and handles the connection protocol from the side of the terminal mailbox
- . and, keeps track of network events for compiling statistics and providing the line trace.

TNS

The functions of the Transport and Network Subsystem are implemented by a network process and an administrative process. The network process is the major of the two processes and occupies a higher priority.

The network process is shared with the BTNS "terminal manager". The term "terminal manager" refers to a particular function of BTNS which

- . provides the dialog conversion between the terminal and the application
- . and, allows the DPS 7 to access terminals of the secondary network over the primary network such as TRANSPAC.

The administrative process is the interface for the asynchronous processing of operations between the network and session layers.

TNS is started up at the same time as BTNS.

TNS performs the following functions

- . synchronizes the DPS 7 with the TRANSPAC switcher
- . sets up the virtual circuit, and transmits and controls X25 packets
- . establishes the transport connection, and transmits and controls fragments
- . and, handles connection requests as follows
 - for terminals, connection to the session is routed through the "terminal manager"
 - for applications, connection to the session is routed directly.

FNPS

When service functions are being performed on a DN7100, its associated FNPS service cannot be started at the same time.

FNPS functions with DNS, the DN7100 system software. At CNC generation, the DN7100 which is to function as the "front-end" system of the DPS 7 "local" system, is declared in the FSYS command, while the associated FNPS service which is to function with the DN7100 in question, is declared in the FNP command.

At run-time, the MTF network control command addressed to the "fsys-name" and specifying AUTO

- . loads the DNS system software in the DN7100
- . and, subsequently starts up the associated FNPS service.

If AUTO was not specified in the MTF command, the associated FNPS service must be started up by the ST system console command addressed to the "fnp-name".

FNPS performs the following functions

- . initializes and manages buffer pools for the interface with VCAM and PIO
- . provides a "pseudo-transport" by relaying the transport connection established by the DN7100 to the session layer in the DPS 7
- . and, manages the allocation of logical channels between "native" and SIRIS modes.

ADM

ADM functions with the NASF file server to perform service functions on the DN7100, see page 2-08.

These service functions are executed through the MTF network control command addressed to the "fsys-name" identifying the DN7100. The operand specified in the MTF command determines the required function as follows

- . SYSGEN : for generating DNS system software necessary for the needs of the DPS 7 host
- . AUTO : for loading the DNS system software previously generated through SYSGEN and, for subsequently starting up the associated FNPS service
- . and, DUMP : for dumping the memory image of the DNS system software.

According to the "load" option specified at CNC generation in the FNP command, the DN7100 can be loaded either remotely by the DPS 7 host or locally from its own diskette.

COMMUNICATIONS NETWORK CONFIGURATOR

In DSA, there is no global network configuration but a configuration of each system with respect to other systems. Each system, in its turn, describes its correspondent systems as it sees them, until all the correspondents, having declared their own network configuration, can mutually identify each other. Unique addressing of each system allows systems throughout the network to communicate.

A system is a set of hardware and software resources. In terms of configuring its network, the system represents a "container" into which objects, which determine the function of the system as a participant of the network, are built. The system configures its own specific network in terms of

- . its own communications software
- . the terminals under its control
- . the systems with which it wants to communicate
- . and, the types of networks that provide the links to its terminals (secondary networks) and its correspondent systems (primary networks).

CNC is a GCOS utility which allows the DPS 7 installation to define its network configuration with specific sets of commands applicable to the resources required for

- . the URP local network (BTNS)
- . the TNS primary network (connection of the DPS 7 over its integrated URP)
- . the FNPS primary network (connection of the DPS 7 over the "front-end" DN7100)
- . and, the TRANSPAC network which provides the links to
 - its terminals connected over it (TRANSPAC/URP secondary network requiring BTNS and TNS support)
 - and, systems of the primary networks, as opposed to point-to-point lines.

The input to CNC are its commands and the configuration of the DPS 7 as defined in the System Resource and Status Table. The SRST is the description of all the hardware and their associated firmware at the DPS 7 "site" as built by the CONFIG utility at installation time.

The output from CNC is a set of communications system tables being

- . BTNS tables for managing the part of the network accessed over the URP, containing the description of all the resources handled by BTNS and TNS, and the means to handle them, such as I/O buffer pools and transport stations
- . FNPS tables for each DN7100 (up to 4) connecting the DPS 7 to the network, describing the "transport" enabling I/O transfers between GCOS and DNS on one side, and VCAM on the other side
- . ADM tables for each of the DN7100s concerning GCOS system files referenced for service functions on the appropriate DN7100
- . VCAM tables containing skeletal descriptions of BTNS, TNS, FNPS and service workstations to be dynamically managed during the communications session
- . and, MAM/QMON tables containing the description of all queues declared, their resource allocations and their structural interface with VCAM.

For details on the CNC utility, refer to the Network Generation Manual.

SECTION III

NETWORKS CONNECTED VIA THE URP

The three types of networks connected through the URP, are

- . the URP local network, supported by BTNS
- . the TRANSPAC/URP secondary network, supported by BTNS and TNS
- . and, the TNS primary network, supported by TNS.

For each network, a brief description is given, however, the user-visibility of the network in terms of CNC commands, is dealt with in detail.

Detailed information on the functions of the URP, BTNS and TNS is given at the end of the section.

COMMUNICATIONS OVER BTNS

The BTNS service, on its own, only supports the URP local network. This type of communications involves

- . URP hardware and firmware, UCLA and MLA, respectively
- . and, BTNS operating with VCAM.

URP Local Network

Handling communications over the URP local network concerns connections between an application and the BTNS "terminal manager".

The BTNS "terminal manager" functions as follows,

- . the Secondary Network Controller logs on the terminal to the application
- . while the Line Monitor assures the data transfer to and from the terminal.

A detailed description of BTNS is treated in "Functional Description of BTNS", and the URP hardware and firmware is dealt with in "Functional Description of the URP".

The DSA layers present in the URP local network, are

- . the application layer
- . the optional presentation layer which can function both on the side of the application and the BTNS "terminal manager"
- . the session layer serviced by VCAM
- . and, the "link" layer which comprises both the data link layer and the physical link layer, serviced by the line driver of the Line Monitor functioning with the URP.

Since message routing is not required, the "link" layer has a direct functional interface with the session layer, thereby bypassing the transport and network layers, see page 1-08.

All objects of the URP local network are visible to the user and are declared by the following CNC commands

- . LINE, CLUSTER, STATN and TERMNL, for generating the URP secondary network tables
- . IDSEQ, for generating the idseq tables
- . GENCOM whose parameters, BTBFSZ/NBBTBF and DABFSZ/NBDABF, are used to generate the BTNS input and output buffer pools, respectively
- . DCTAP, for identifying the application if any terminals are "assigned" to it, the exception being TDS which need not be declared with a DCTAP command
- . and, QUEUE, if the queue pertains to a terminal.

In "Support for Terminals in URP Local Network", the following are to be noted

- . all line procedures, except TC, are shown
- . all terminals supported, except TTY terminals, are listed
- . and, the PVE line procedure for the Mini 6/MFS is included to allow the RBF6/FTF6 connection to the DPS 7, see page 2-06.

Support for Terminals in URP Local Network

List of Abbreviations & Mnemonics

- CH : Connection Handler
- I/O RS : I/O Request Supervisor
- LDH : Local Dialog Handler
- LM : Line Monitor
- SNA : Secondary Network Administration
- SNC : Secondary Network Controller

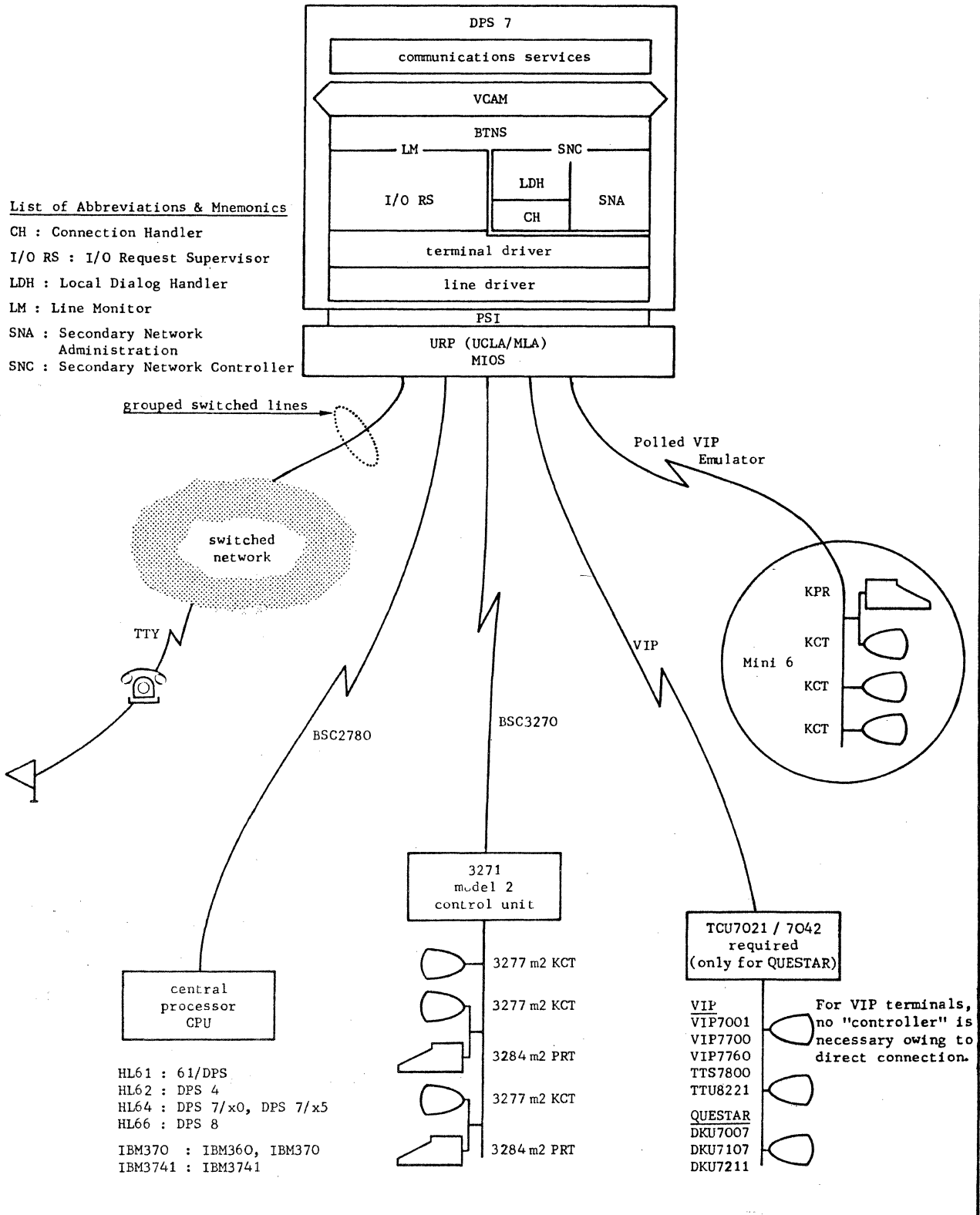

COMMUNICATIONS OVER TNS

TNS functions with URP hardware and firmware to support two types of networks, namely,

- . the TRANSPAC/URP secondary network
- . and, the TNS primary network.

TRANSPAC/URP Secondary Network

Communications over this network involves

- . the BTNS "terminal manager", for managing the terminals
- . TNS, for providing the transport and network services over TRANSPAC
- . and, VCAM.

The two classes of TRANSPAC terminals currently supported are

- . PAD terminals, which are TTY and Telex terminals
- . and, CSX25 terminals, which are synchronous terminals that operate through either a convertor or terminal concentrator, referred to by the common term "controller".

The objects of the TRANSPAC/URP secondary network are visible to the user and are declared by the following CNC commands

- . PVC, RDTE and RDTN, for generating the transport station (TS) tables
- . IDSEQ, for generating the idseq tables
- . GENCOM whose parameters are
 - BTBFSZ/NBBTBF and DABFSZ/NBDABF, for generating the BTNS input and output buffer pools, respectively
 - and, PLGNB, for specifying the number of rdtn's connectable over TRANSPAC through either PAD or CSX25
- . LSUB, for defining the line over which the virtual circuit is to be established over the TRANSPAC subscription
- . DCTAP, for identifying the application if any rdtn's are "assigned" to it, the exception being TDS which need not be declared with a DCTAP command
- . and, QUEUE, if the queue pertains to an rdtn.

In "Support for Terminals in TRANSPAC/URP Secondary Network", the DSA layers common to both classes of terminals are shown, however the difference in the connection mechanism is as follows

- . for CSX25 terminals, the transport layer is implemented by the DSA transport station
- . whereas, for PAD terminals, the network layer interfaces directly with the session layer.

Support for Terminals in TRANSPAC/URP Secondary Network

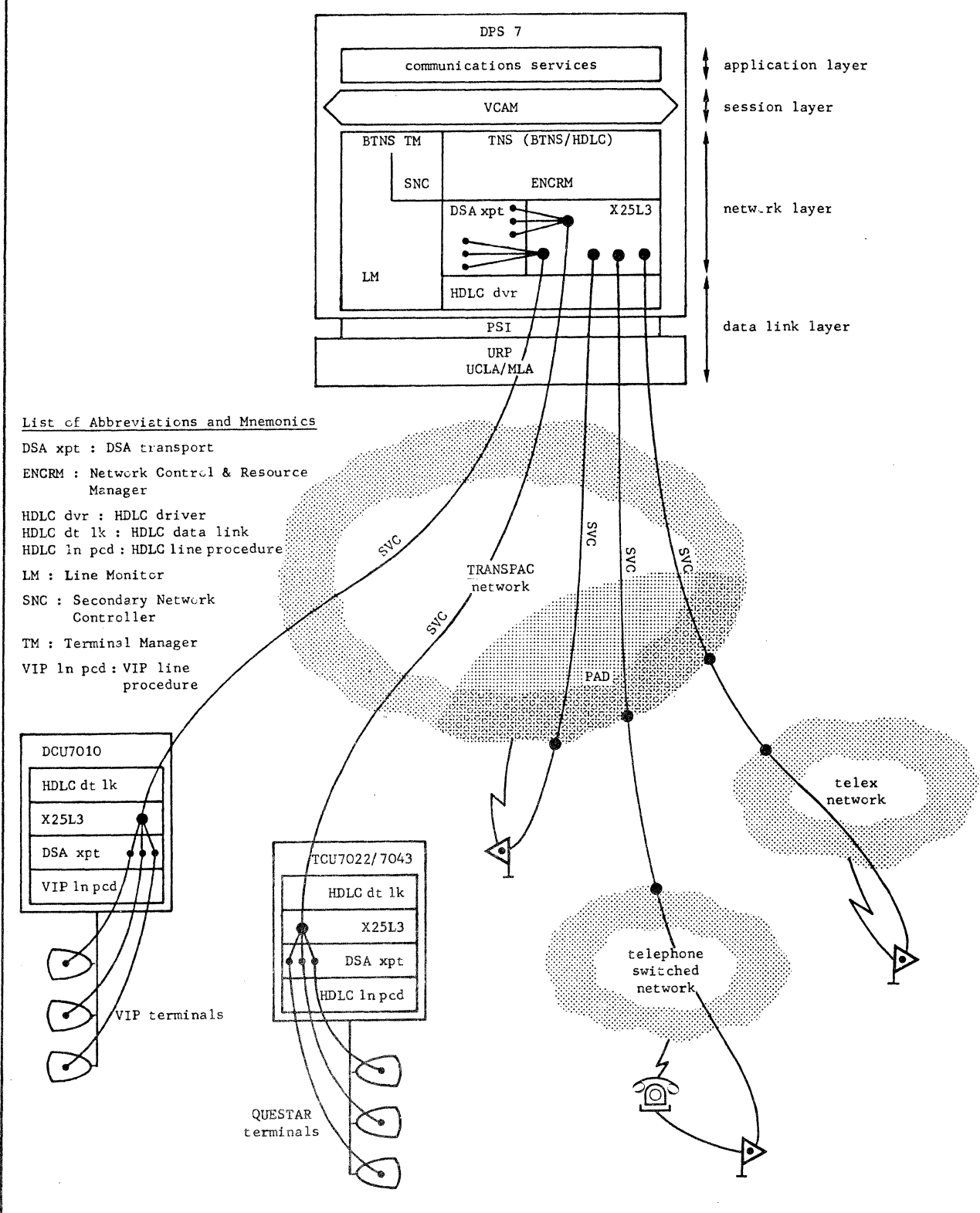

List of Abbreviations and Mnemonics

- DSA xpt : DSA transport
- ENCRM : Network Control & Resource Manager
- HDLC dvr : HDLC driver
- HDLC dt lk : HDLC data link
- HDLC ln pcd : HDLC line procedure
- LM : Line Monitor
- SNC : Secondary Network Controller
- TM : Terminal Manager
- VIP ln pcd : VIP line procedure

PAD TERMINALS

PAD terminals comprise the following types of rdtn's connected over TRANSPAC through its PAD service, being

- . TTY terminals using either a leased line or a switched network (telephone)
- . and, Telex terminals using the Telex network.

Whereas the DPS 7 can call Telex terminals and TTY terminals using leased lines, only TTY terminals using a switched network can call the DPS 7.

The PAD service enables asynchronous terminals which are unable to generate or receive packets in the HDLC line procedure to connect over TRANSPAC. By implementing the TTY line procedure, the PAD service functions as a compatibility "adaptor" for TRANSPAC and such terminals. It also handles the local dialog to set up the virtual circuit which corresponds 1-to-1 with each terminal.

From the PAD service on the TRANSPAC side, data passes on to the DPS 7 side and is handled by the UCLA/MLA and the HDLC driver.

The modules of both TNS and BTNS interact to provide the following consecutive functions

- . ENCRM performs two roles, namely
 - allocates the necessary network resources for the virtual circuit established
 - and, reports the demand for the logical connection to the BTNS Secondary Network Controller (SNC)

Conversely, SNC reports the disconnection demand to ENCRM which then proceeds to deallocate the resources.

- . SNC logs the terminal to the application
- . X25L3 exchanges the data record with the BTNS Line Monitor (LM)

The term "record" is used since the BTNS "terminal manager" performs a certain amount of presentation control in processing data for removal of control codes.

- . LM transfers the data record assembled as a message to the application.

PAD terminals are declared by the following CNC commands at network generation

- . RDTE which specifies PAD and the subscription number over which the virtual circuit for the rdtn's is to be established
- . and, RDTN, one or more of which can be "attached" to the rdte, and is restricted to the following rdtn-types : DTU7171, TTU8124, TTU8126 and TTU8128.

CSX25 TERMINALS

CSX25 terminals are synchronous rdtn's which connect directly over TRANSPAC through the intermediary of their "controllers", namely,

- . either the DCU7010 convertor for VIP7001/7700/7760, TTS7800 and TTU8221
- . or the TCU7022/7043 terminal concentrator for DKU7007/7107/7211.

The difference between the convertor and the terminal concentrator is, that on the terminal side,

- . whereas the DCU7010 operates on the VIP line procedure
- . the TCU7022/7043 operates on the HDLC line procedure.

However, on the side of TRANSPAC, both these "controllers"

- . operate on the HDLC line procedure for direct synchronous links over the data link layer
- . and, implement the X25 Level 3 part of the network layer, and the transport layer.

The virtual circuit is established when

- . either the terminal requests access to an application in the DPS 7
- . or the DPS 7 application requests a terminal.

Once the virtual circuit is established, more than one transport connection can be multiplexed over its path. The transport connection is established and negotiated between the DPS 7 and the "controller". Each transport connection represents an active pair-set of terminal/application.

The transport connection is released when the terminal/application pair-set requests disconnection. The virtual circuit is released when the last active transport connection multiplexed over it, is released, that is, when the last active terminal disconnects.

Both the network and transport layers are activated at the time of connection. The modules of both TNS and BTNS interact to provide the following consecutive functions

- . X25L3 establishes the virtual circuit
- . the DSA transport station (DSA xpt) reports the request for a transport connection which it receives, to the BTNS Secondary Network Controller (SNC) via ENCRM, which take the following consecutive actions
 - ENCRM allocates the necessary network resources for the transport connection
 - and, SNC completes the logical connection by logging the terminal to the application
- . DSA xpt cumulates all the fragments to constitute the letter and transfers it to VCAM via the BTNS Line Monitor (LM)
- . LM performs presentation control on the data record by adding or stripping the VIP headers and trailers, on output from and input to, the application, respectively.

CSX25 terminals are declared by the following CNC commands at network generation

- . RDTE which specifies CSX25 and the subscription number over which the virtual circuit for the rdtn's is to be established
- . and, RDTN, one or more of which can be "attached" to the rdte, and is restricted to only the terminals "attached" to the "controller", not the "controller" itself.

TNS Primary Network

TNS, on its own, only supports the DSA primary network. This type of communications involves

- . URP hardware and firmware, UCLA and MLA, respectively
- . and, TNS operating with VCAM.

TNS provides a transport service for applications in remote systems to communicate with those in the DPS 7, by

- . establishing the transport connections
- . administering the network routes
- . and, managing the data link for accessing any remote system configured within the network.

A detailed description of TNS is treated in "Functional Description of TNS", and the URP hardware and firmware is dealt with in "Functional Description of the URP".

The objects of the TNS primary network are visible to the user and are declared by the following CNC commands common to both a connection over the TRANSPAC switched virtual circuit and a connection over a point-to-point line

- . For the "local" DPS 7
 - LSYS, LSC and LTS, for defining, respectively, the local system, its "session-control" and, its "departure" transport station
- . For the "remote" correspondent
 - RSYS, RCS and RTS, for defining, respectively, the remote system, its "session-control" and, its "arrival" transport station
 - and, NR, CP and XPRTC, for defining the "access path" linking the lts with the rts, in terms of the network route, communications path and transport protocol, respectively.

The transport station of either system functions as the "server" to its respective "session-control".

The differences in the CNC declarations for a switched virtual circuit and a point-to-point line are as follows

- . For a switched virtual circuit
 - LSUB must be present, for defining the LINE over which the virtual circuit is to be established over the "local" TRANSPAC subscription allowing the lsys to "enter" the network
 - CP must identify the lsub
 - and, RTS must define the "remote" TRANSPAC subscription allowing the lsys to "exit" from the network to connect to the rsys
- . For a point-to-point line
 - CP must define the LINE used for the connection.

The following CNC commands are mandatory for syntax but not for function, namely

- . PVC, RDTE and RDTN, if a permanent virtual circuit has been subscribed to, in which case, they follow LSUB
- . STATN and TERMNL, which follow LINE.

TNS (BTNS/HDLC) Support of Primary Networks

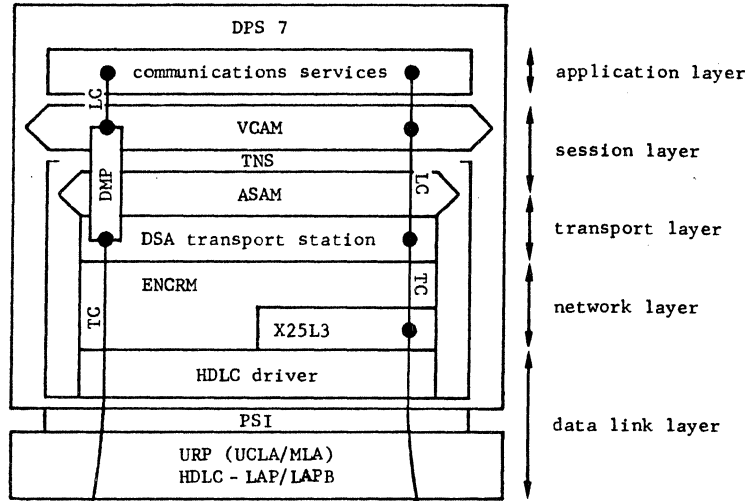

List of Abbreviations and Mnemonics

- ASAM : Asynchronous Access Method
- DMP : Direct Multiplexing
- ENCRM : Network Control and Resource Manager
- LC : Logical Connection
- S : Switch
- TC : Transport Connection

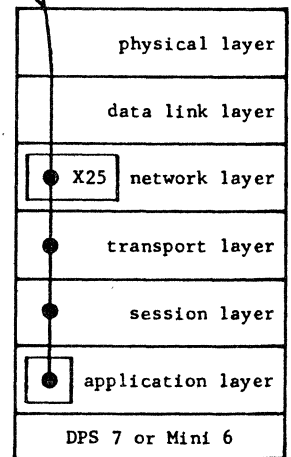
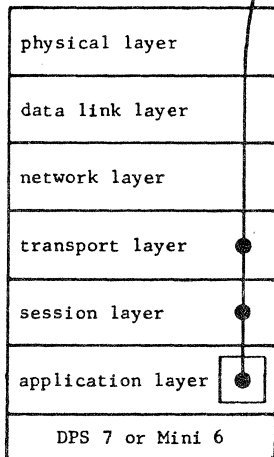
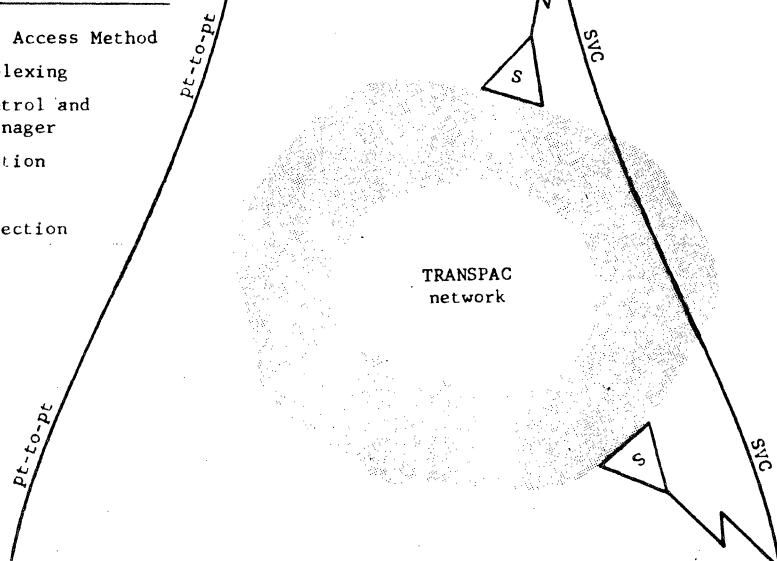

NETWORK ROUTE MANAGEMENT

The two types of network routes are the switched virtual circuit and the point-to-point line. Their respective management differs as follows

- . for a point-to-point line, the network route is established when the line is "opened", thereby making the network available
- . for a switched virtual circuit, the network route is established as follows
 - the HDLC driver activates the link by
 - . "opening" the line from the DPS 7 to TRANSPAC
 - . and, "calling up" the "remote" subscription number to complete the connection to the rts
 - X25L3 synchronizes the DPS 7 with the TRANSPAC switcher for establishing the virtual circuit
 - and, ENCRM allocates the necessary resources for the network route.

More than one network route and, at least two "remote" subscription numbers can be declared in the RTS command. The network routes are evenly distributed over the subscriptions, and are mapped one-for-one over the virtual circuits.

TRANSPORT CONNECTION MANAGEMENT

When the DSA transport station (DSA xpt), which manages the network interface, receives a connection request from either the network or VCAM, the transport connection is established as follows

- . for a point-to-point line, the DSA xpt directly multiplexes the transport connection one-for-one over the network route
- . for a switched virtual circuit, the DSA xpt multiplexes one or more transport connections over a network route.

The DSA xpt synchronizes itself with the rts and regulates data flow through the transport connection now established. Where two systems are connected over the primary through both point-to-point lines and switched virtual circuits, the data flow is directed as follows

- . through the network route(s) over the point-to-point line(s) first
- . and, then if any overflow occurs, through the network route(s) mapped over the virtual circuit(s).

FUNCTIONAL DESCRIPTION OF THE URP

The URP communications functions are provided by a set of microprograms for handling communications lines.

Microprogrammed firmware is composed of microprocesses which are

- . the micro-operating system (MIOS) for dispatching a task
- . and, support management for each type of hardware, which for communications, is also referred to as "attachments".

The components in the URP responsible for implementing communications, are

- . the universal communications line adaptor (UCLA)
- . and, the multiline attachment (MLA).

Universal Communications Line Adaptor

The UCLA or "bit machine" is an aggregate of hardware, 1 per communications line, in charge of managing the electrical interface according to the transmission and connection characteristics of the line connected, namely

- . whether synchronous, using "watchdog" timers, or asynchronous, using "start" and "stop" bits
- . and, whether "dial-up" for switched lines, or leased and local for non-switched lines.

The functions of the UCLA are

- . the control of the electrical interface signals
- . and, the assembly of characters from bits received over the line, and, the disassembly of characters sent by the DPS 7 into bits.

Multiline Attachment

The MLA or "byte machine" is a piece of firmware whose functions are parameterized through tables loaded by BTNS.

The terminal and line table (TLT) contains tuning, system and, hardware and line procedure parameters which are built up as follows

- . parameters not accessible to system software are initialized by the LPGEN utility during URP image generation
- . while parameters visible to system software are initialized with values specified in the appropriate parameters of the LINE command at CNC generation.

Each type of line has its own TLT which contains all the parameters characterizing its functions.

The functions of the MLA are

- . dispatching tasks to be performed over the different lines
- . and, performing service functions for all the line procedures handled by the URP.

Service functions concern the presentation of data being

- . character translation from ASCII (external code) to EBCDIC (internal code), and vice versa, from the translation code table (TCT) applicable to the specific line procedure, see note below
- . blocking characters into messages, by detecting the "end-of-message" indicator
- . inserting "fill" characters at the end of the line of text on output to allow a printer terminal, for example, to perform a "carriage-return" before resuming printing
- . and, replacing erroneous characters when a parity errors occur.

Note : The TCT is standard for a given line procedure. However, depending on the operational requirements of the terminal(s), the TCT can be altered through the TCTNM parameter of the LINE command at network generation, as follows

- . TCTNM=ASCII, for BSC2780 and BSC3270 line procedures, whereby instead of ASCII to EBCDIC translation, the external code ASCII remains unchanged
- . and, TCTNM=SPTY, for TC and TTY line procedures, whereby the standard TCT is patched for additional or substitute "editing" codes.

Each line procedure has its own support management or "specific attachment" which is activated by the MLA for handling its functions, namely

- . polling and selecting, or point-to-point control handling
- . detecting transmission errors and performing retries
- . detecting terminal and line failures to report to BTNS
- . detecting status changes on "timeout" to report to BTNS
- . and, controlling off-line operations on terminals, such as printing or read/write operations on diskette.

Most of these operational functions are parameterized through tables dynamically updated by BTNS at startup and during the communications session through network control commands, namely

- . MTP, for modifying the polling sequence
- . MTL, for modifying the "timeout", read/write ratio and line speed
- . and, MTE, for editing messages in a terminal-queue.

The line procedures supported on the DPS 7, are

- . point-to-point : BSC2780, HDLC X.25, TC, TTY/TTY-R, VIP(A) and VIP(S)
- . and, multipoint : BSC3270, TC, VIP(S).

FUNCTIONAL DESCRIPTION OF BTNS

The functions of BTNS are performed by a monoprocess load module H_BTNS which is partitioned into two principal modules

- . the line monitor
- . and, the secondary network controller.

Line Monitor

The line monitor is composed of the following functions

- . I/O request supervisor
- . line drivers
- . and, terminal drivers.

I/O REQUEST SUPERVISOR

The I/O request supervisor

- . dispatches I/O requests and "attention" notifications to either the line driver or the secondary network controller, namely
 - input requests sent by the MLA at the end of "read" channel programs
 - output requests sent by VCAM as a result of "send's" executed by the communications services
 - and, "attention" notifications sent by the MLA indicating changes in hardware status and/or the need for operator intervention
- . enqueues and dequeues output requests depending on the availability of the lines
- . handles channel programs for data exchanges with the MLA
- . and, maps the activity of terminals on to the DSA session protocol through the VCAM interface.

LINE DRIVERS

The DSA link layer is implemented by the MLA in the URP and the line drivers. Each line procedure, because of its specific characteristics, has its own line driver and its own MLA support.

The line driver

- . generates the frame on output
- . controls the frame on input
- . monitors status changes over the line(s)
- . and, manages the polling of multipoint lines according to
 - line event notifications
 - and, the network control command(s) issued.

TERMINAL DRIVERS

The terminal driver does not represent a single function. It is an activity or a set of activities specific to the management needs of a class of terminals.

The basic requirements for managing the terminal is contained in the terminal control block which gives such information as

- . the type and subtype of the terminal either declared at network generation or defaulted through specifying an "idseq" at run-time
- . the status of the terminal dynamically set by the BTNS "terminal manager"
- . and, run-time variables entered by the user at the terminal affecting its performance, such as
 - either simulating line visibility on the IBM3270 (SML and RML)
 - or acceptance of small letters as capitals for terminals without the "CAPITALS LOCK" such as Iriscope 200 (RLC and SLC)
 - or allowing the use of the APL character set for the AJ832/833 (APL and NAPL).
 - or declaring additional "delete" characters (DC).

The type and subtype of the terminal currently declared at logon allows messages to be formatted according to the hardware characteristics, such as line length and page scroll, in the case of screen terminals. In the case of managing multidevice terminals, the I/O request supervisor is made aware not to send data simultaneously to different devices which are not supported.

Secondary Network Controller

The secondary network controller is composed of the following functions

- . local dialog handler
- . connection handler
- . and, secondary network administration.

LOCAL DIALOG HANDLER

Local dialog is the exchange of messages between the user at a terminal and the BTNS "terminal manager". These messages are

- . either solicited, involving logon dialog and responses to local commands, such as displaying the status of the application(s)
- . or unsolicited, involving broadcasts from the network control operator and information on the changes in status of the terminal.

The logon dialog allows the user to request a logical connection between his terminal-mailbox and the application-mailbox, see pages 1-24 and 1-29.

This dialog is conducted according to the physical characteristics of the terminal and the connection capability provided, such as whether the terminal is "automatic" or manual, and if it has been "assigned" to an application.

The user, logging on from an interactive terminal, provides the local dialog handler with security parameters, being the user-identification and password.

For further details, see "Establishing the Logical Connection" in the Terminal Operations Manual.

CONNECTION HANDLER

The connection handler manages the VCAM interface and updates the terminal connection status within the TCB tables.

The connection procedure, which involves setting up and maintaining the logical connection, can be suspended

- . either at the request of the user or on timeout
- . or when the maximum number of authorized connections to the application-mailbox has been reached.

If the application-mailbox has been specified with the queueing capability, VCAM will queue the request and the connection procedure will resume when a connection becomes available on the mailbox.

The connection handler logs on an "automatic" terminal whenever it is available and, if the terminal is "assigned", connects it to the application whenever a connection becomes available.

The connection is implemented according to the direction of the request, namely

- . either from a terminal connecting to an application
- . or from an application requesting a terminal.

Connection from a Terminal to an Application

The connection handler prepares all the information needed by VCAM to build the "request logical connection" ILCRL, from

- . addressing parameters which are retrieved from the TCB of the "initiator" terminal-mailbox
- . security parameters which are retrieved by the local dialog handler
- . and, parameters for the dialog and presentation protocols, which are retrieved from the TCB tables.

Once all the information has been gathered, the connection handler requests VCAM for a logical connection.

As a result of the negotiation and checking performed by VCAM, VCAM will either "accept" or "reject" the request, and inform the user at the terminal accordingly, with a local dialog message.

If the request is "accepted", the terminal is connected to the "destination" application-mailbox.

If the request is "rejected", the terminal is returned to the IDLE state and is again available for an attempt at a new connection.

Connection from an Application to a Terminal

The connection handler

- . identifies the terminal requested by the application by means of the ILCRL parameters sent by VCAM
- . checks the availability of the terminal, namely,
 - whether logically available, for example, a terminal declared as AUTO must be in the LOGGED state
 - whether not already connected to another application
 - and, whether no shutdown is in progress to remove the terminal from the network configuration.

The connection handler "accepts" or "rejects" the connection passing on to VCAM the necessary parametric values to build the ILCAL.

If the ILCAL is an "accept logical connection",

- . the terminal is set in the CONNECTED state
- . and, the user at the terminal is informed of the connection with a local dialog message.

If the request is "rejected", the status of the terminal is not modified.

SECONDARY NETWORK ADMINISTRATION

Secondary network administration involves a variety of functions such as

- . providing the interface to process network control commands and local terminal operator commands
- . monitoring the execution of these commands with respect to the status of the secondary network objects affected, such as LINE, STATN and TERMNL
- . reporting unsolicited changes in status of network components to the network control operator, such as line failures and station availability
- . and, managing the workstation itself, that is controlling the startup and shutdown of BTNS.

The IOF process associated with the network control operator checks the validity and syntax of network control commands. If the command concerns the secondary network, the IOF process duly notifies BTNS which then proceeds to execute the command through the secondary network administration function.

Local terminal operator commands are prefixed by a "break qualifier" which is defined through the SIMBRK parameter of the GENCOM command at network generation. The line monitor scans the input data flow to detect the "break qualifier". Once the "break qualifier" is detected, the line monitor activates the secondary network administration function to deal with the command.

Secondary network administration manages the BTNS workstation as follows

- . at startup, it assumes the activity of the line monitor by simulating an RT command on each line which has not been declared CLOSED at network generation
- . and, at shutdown, it notifies all connected applications of the receipt of the TT command and then waits for all terminals to disconnect.

FUNCTIONAL DESCRIPTION OF TNS

The Transport and Network Subsystem is implemented by two processes

- a network process which is shared with BTNS for implementing the transport and network layers
- and, an administrative process for the asynchronous processing of operations and for providing the session interface.

The network process has a higher processing priority of the two processes.

TNS provides the support of its DSA layers through the following modules

- the transport layer is implemented by the DSA transport station (MUX)
- the network layer is implemented by both X25L3 and ENCRM
- and, the data link layer is handled by the HDLC driver.

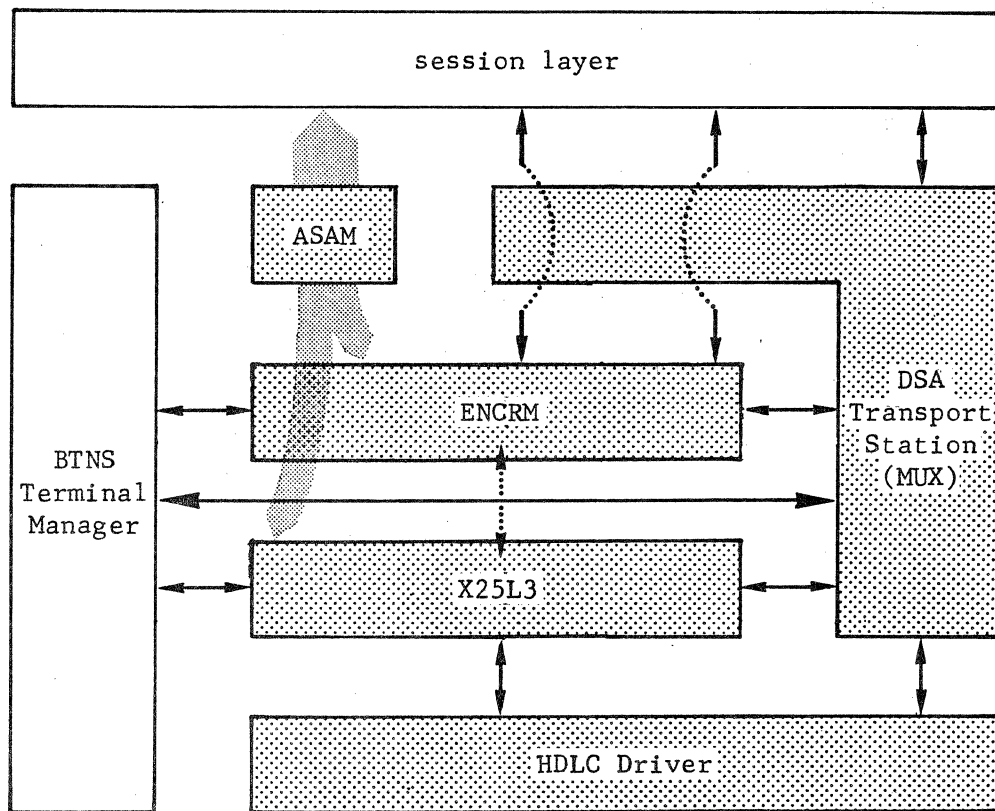

In the diagram, the principal features to note are the following

- TNS modules are shown shaded, the abbreviations being
 - ASAM, Asynchronous Access Method
 - MUX, being the "multiplexor" of the DSA transport station
 - ENCRM, Network Connection and Resource Manager
 - X25L3, being the TNS module for implementing the CCITT X25 level 3
 - and, HDLC driver, for managing lines over which the "High level Data Link Control" protocol is implemented
- and, the presence of the session layer to show the session interface implemented directly by TNS acting as the intermediary for the BTNS "terminal manager".

DSA Transport Station (MUX)

The transport layer is composed of automata implementing the DSA transport protocol.

The DSA transport station handles the full DSA transport protocol by

- . synchronizing itself with remote transport stations
- . establishing and disestablishing the transport connection whose status is reported to ENCRM
- . assembling fragments into letters to pass on to the session layer, and disassembling letters received from the session layer into fragments
- . and, regulating data traffic passing through transport connections.

The conveyance of the assembled letters depends on the correspondent, namely

- . if the correspondent is a terminal, the DSA transport station exchanges the letters through the BTNS interface, since the BTNS "terminal manager" is responsible for managing the session interface dedicated to terminals
- . however, if the correspondent is a "remote" system in a primary network, the DSA transport station directly exchanges the letters with the session layer.

Network Connection and Resource Manager (ENCRM)

ENCRM operates on network connections and disconnections, which are demanded by either the system or the network.

The system may request ENCRM to connect

- . either a terminal, in which case, the demand for a network connection will pass from the session layer through BTNS to ENCRM
- . or a "remote" system, in which case, the demand for a network connection is routed directly from the session layer to ENCRM.

Conversely, a request coming from the network will be routed to the session layer either through the intermediary of BTNS for terminals, or directly in the case of "remote" systems.

When processing a request for a network connection, ENCRM allocates whatever network resources are required for the connection to be established by the DSA transport station. For example, a request coming from the system is translated as a demand from a communications service in the application layer. In which case, ENCRM allocates specific resources for the service to function.

A request for a network disconnection passes first to the DSA transport station which disestablishes the connection before ENCRM deallocates the network resources.

ENCRM functions with X25L3 to handle the DSA network protocol.

X25 Level 3

The X25 Level 3 automata, composing in part the network layer, is specialized to handle connections over the TRANSPAC public network as follows

- . synchronizes the DPS 7 "local" system with the TRANSPAC switcher
- . establishes and disestablishes the switched virtual circuit(s) through exchanging control packets with the TRANSPAC switcher
- . reports the status of the virtual circuit(s) to ENCRM
- . assembles X25 messages from X25 packets, and vice versa (see text following)
- . and, controls the flow of data over the virtual circuits.

The X25 message is handled according to its conveyance and the correspondent concerned, namely,

- . in the case where a PAD terminal is concerned, the X25 message is exchanged with the BTNS "terminal manager" which manages the session interface for the secondary network
- . however, if a virtual circuit is used as the transport path, being either the network route of a primary network, or an access path to a CSX25 terminal, the X25 message is exchanged with the DSA transport station.

Asynchronous Access Method (ASAM)

ASAM is an internal TNS process which provides for the asynchronous processing for the session and network layers. The intermediate transport layer is not affected.

ASAM includes a processor for network administrative commands addressed to TNS, namely

- . DT, HT and RT, specifying objects of the primary network
- . MNT, for maintaining tables associated with the primary network object
- . and, "injector" commands for simulating the session layer in "loop" and "debug" modes.

HDLC Driver

The HDLC driver handles the data link layer by managing all I/O operations over HDLC lines connected to the URP.

SECTION IV

NETWORKS CONNECTED VIA THE DN7100

The three types of networks connected through the DN7100, are

- . the DN7100 local network
- . the TRANSPAC/DN7100 secondary network
- . and, the FNPS primary network.

The support of these networks is provided by FNPS.

For each network, a brief description is given, however, the user-visibility of the networks in terms of CNC commands, is dealt with in detail.

Detailed information on the functions of the DN7100 and FNPS is given at the end of the section.

COMMUNICATIONS OVER FNPS

The FNPS service functions in tandem with the System Communications Facility (SCF) of the DN7100.

SCF initializes the logical connection between two correspondents, represented by their mailboxes, by determining the DNS task for building the "request logical connection" ILCRL, namely,

- . the device controller task for local and PAD terminals, in which case the device controller requests session-control to send the ILCRL
- . or, the transport station task for CSX25 terminals and DSA remote systems, in which case, the transport station directly sends the ILCRL.

When the TPM receives the ILCRL, it passes it to VCAM which responds with an "accept logical connection" ILCAL. The logical connection is now established between the mailboxes.

The DPS 7 does not distinguish the origin of the ILCRL, and as far as it is concerned, the destination mailbox, over whatever type of network, is totally transparent to it.

For this reason, all terminals in FNPS networks are not declared in the CNC generation. However, DSA remote systems are declared since each represents a network resource which must be known to, and managed by the FNPS service associated with the DN7100 to which the remote system is connected.

The visibility of FNPS networks is therefore restricted to the following CNC commands

- . FNP, whose parameters define the TPM tables and generate the buffer pools, as follows
 - INBFSZ and INBFNB, for the FNPS input buffer pool
 - OUTBFSZ and OUTBFNB, for the FNPS output buffer pool
- . FSYS and FSC, for defining, respectively, the DN7100 and its "session-control"
- . and, RSYS and RSC, in the case of the FNPS primary network, for defining, respectively, the DSA remote system and its "session-control".

DN7100 Local Network

Except for TTY asynchronous terminals, all transmission procedures are handled by DCS. However, DCS handles all connection requests whatever the nature of the line and transmission procedures.

The procedure for establishing the connection is in the following sequential order

- . TSV detects the connection request from the terminal
- . the request is passed on to DCS which activates SCF
- . SCF creates the device controller task and activates it
- . the device controller makes a request to session-control
- . and, session-control sends the "request logical connection" ILCRL.

Support for Terminals in DN7100 Local Network

List of Abbreviations and Mnemonics

- ADCOM : Administrative Commands
- DCS : Data Communications System
- DSA xpt : DSA transport
- HDLC dt lk : HDLC data link
- LC Handler : Logical Channel Handler
- In pcd : Line Procedure (HDLC & VIP)
- MLC : Multiline Controller(s)
- PIO : Physical I/O
- Pseudo-xpt Mgt : Pseudo-transport Management
- SCF : System Communications Facilities
- TM : Terminal Manager
- TPM : Transport Module
- TPM-EVT : TPM Events
- TS : Terminal Support (Synchronous and Asynchronous)
- TSV : Transmission Supervisor

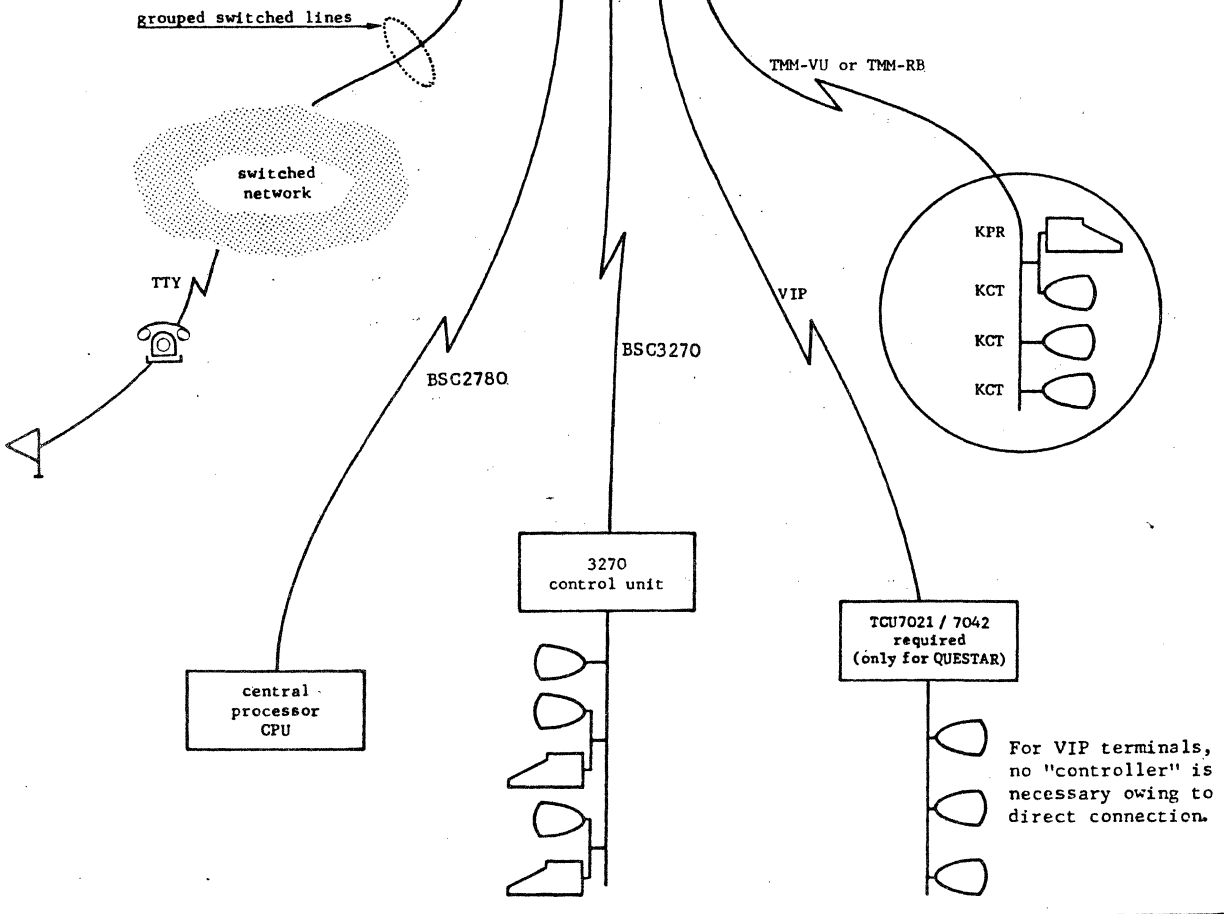
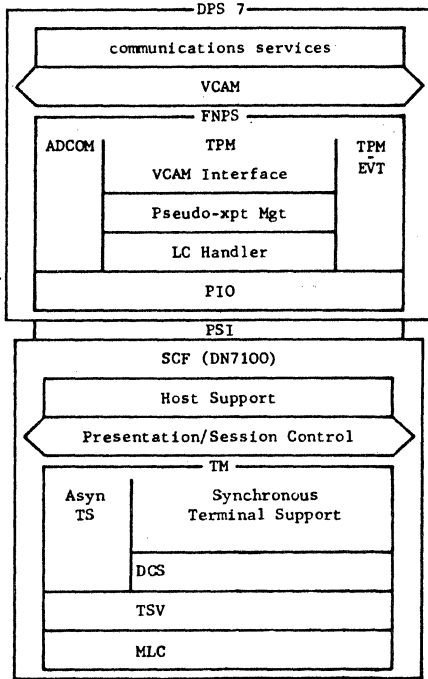

TRANSPAC/DN7100 Secondary Network

The two classes of TRANSPAC terminals currently supported are

- . PAD terminals, which are TTY and Telex terminals which are unable to generate or receive packets in the HDLC line procedure to connect directly to TRANSPAC, and hence must use the PAD service as a transmission interface
- . and, CSX25 terminals, which are connected through either the DCU7010 convertor or the TCU7022/7043 terminal concentrator, and therefore
 - operate on the HDLC line procedure, whatever the VIP or HDLC line procedure is used between the terminal and the "controller", for direct synchronous links over the data link layer
 - and, implement the X25 Level 3 part of the network layer, and the transport layer.

The explanation for the connection procedure mechanism is illustrated by the diagram on the facing page and the following "FNPS Primary Network" diagram.

The procedure for establishing the connection is in the following sequential order

- . TSV detects the connection request over the TRANSPAC network
- . the request is passed to DCS which activates SCF
- . SCF launches the transport service which, in turn, calls routing management (NR Mgt)
- . NR Mgt manages the network connection request by activating the X25 Level 3 function (X25L3)
- . X25L3 establishes the virtual circuit over which the network route is mapped
- . from now on, dispatching the "request logical connection" ILCRL depends on the class of terminal
 - for PAD terminals :
 - . SCF creates a device controller task and activates it
 - . the device controller makes a request to session-control
 - . and, session-control sends the ILCRL
 - for CSX25 terminals :
 - . SCF creates a transport station task and activates it
 - . the transport station (DSA xpt stn) performs the consecutive actions of
 - firstly, establishing the transport connection
 - and, sending the ILCRL.

Support for Terminals in TRANSPAC/DN7100 Secondary Network

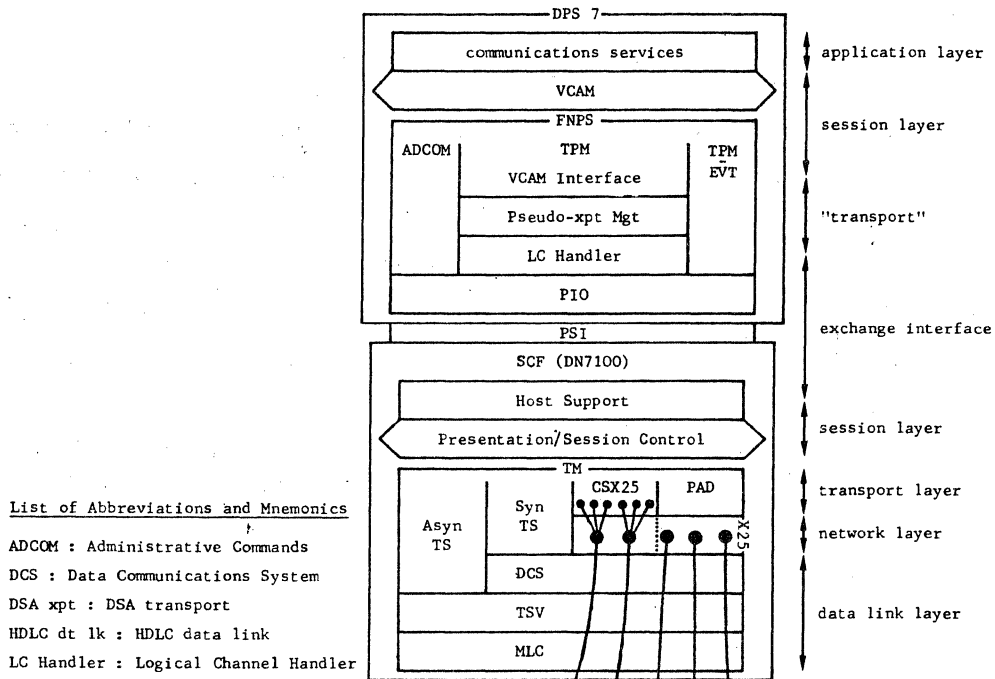

List of Abbreviations and Mnemonics

- ADCOM : Administrative Commands
- DCS : Data Communications System
- DSA xpt : DSA transport
- HDLC dt lk : HDLC data link
- LC Handler : Logical Channel Handler
- ln pcd : Line Procedure (HDLC & VIP)
- MLC : Multiline Controller(s)
- PIO : Physical I/O
- Pseudo-xpt Mgt : Pseudo-transport Management
- SCF : System Communications Facilities
- TM : Terminal Manager
- TPM : Transport Module
- TPM-EVT : TPM Events
- TS : Terminal Support (Synchronous and Asynchronous)
- TSV : Transmission Supervisor

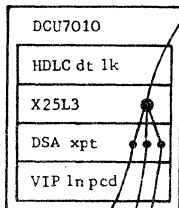

VIP terminals

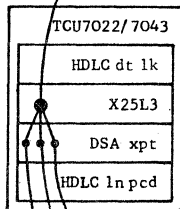

QUESTAR terminals

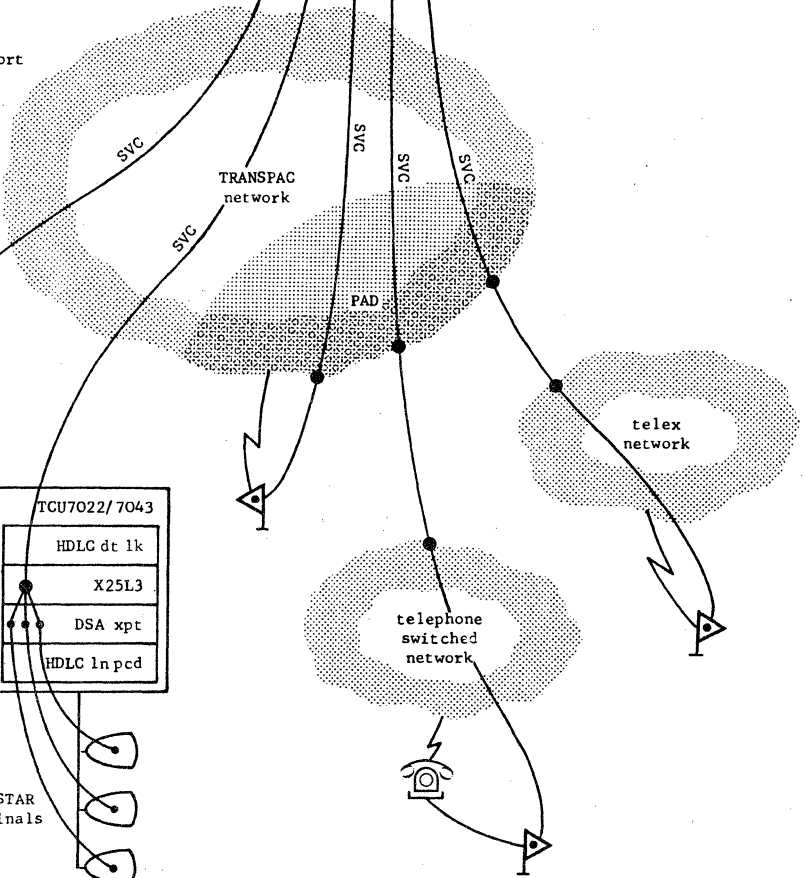

FNPS Primary Network

Since the DPS 7 is relieved of the transport and network administrative functions by the DN7100, it has no visibility of the primary network, cf. "URP Connection", page 1-07.

The transport declared in the FNP command describes the operation of the FNPS service for

- . mapping the DN7100 over the PSI of the DPS 7 through the FSC command
- . and, attaching all the DSA remote systems associated with it through their respective RSC commands.

The concept of the transport station in the context of the FNPS service is only figurative, since the DPS 7 does not determine the "access path" to the remote correspondents using this connection.

The real transport station resides in the DN7100 and acts as the "server" for VCAM with the FNPS service as the "relay".

At the end of this section, functional descriptions of the DN7100 and FNPS are treated in detail to show the inter-relationship between the two sets of communications software.

The procedure for establishing the connection to an application mailbox in a remote system, is in the following sequential order

- . TSV detects the connection request
- . the request is passed to DCS which activates SCF
- . SCF launches the transport service which, in turn, calls routing management (NR Mgt)
- . NR Mgt manages the network connection request according to the connection used between the systems, namely
 - for a point-to-point line, NR Mgt directly establishes the network route
 - for a TRANSPAC switched virtual circuit, the following consecutive actions occur
 - . NR Mgt activates the X25 Level 3 function (X25L3)
 - . and, X25L3 then establishes the virtual circuit, over which the network route is mapped
- . once the network route is established, SCF creates a transport station task and activates it
- . the transport station (DSA xpt stn) performs the consecutive actions of
 - firstly, establishing the transport connection
 - and, sending the "request logical connection" ILCRL.

FNPS Support of Primary Networks

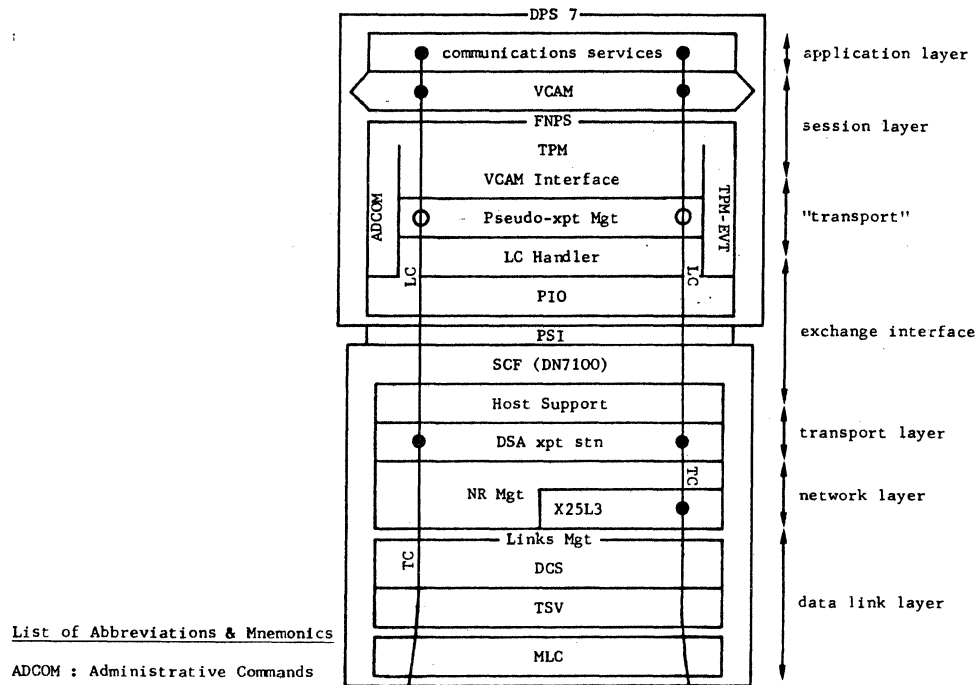

List of Abbreviations & Mnemonics

- ADCOM : Administrative Commands
- DCS : Data Communications System
- DSA xpt stn : DSA Transport Station
- LC : Logical Connection
- LC Handler : Logical Channel Handler
- Mgt : Management
- MLC : Multiline Controller(s)
- NR : Network Routing
- PIO : Physical I/O
- Pseudo-xpt : Pseudo-Transport
- SCF : System Communications Facilities
- TC : Transport Connection
- TPM : Transport Module
- TPM-EVT : TPM Events
- TSV : Transmission Supervisor

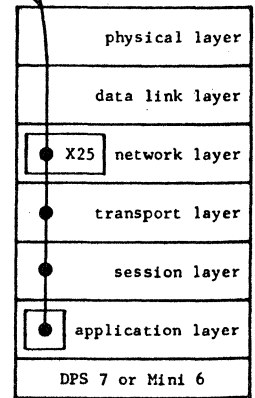
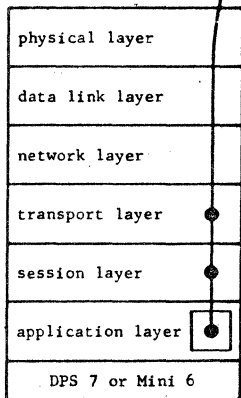

FUNCTIONAL DESCRIPTION OF THE DN7100

The DN7100, functioning as a front-end processor, has two physical connections at either end

- . on the side of the DPS 7 host, the PSI managed by the I/O driver (PIO) of FNPS, providing the DN7100 "host support"
- . and, on the side of the network, the Multiline Controller (MLC) which is
 - managed by the Transmission Supervisor (TSV)
 - and, connected to the network by line adaptors using the various line procedures.

In the case where the DN7100 is connected to the DPS 7 host over 2 PSIs, each of the PSIs must be declared with separate FNPS services.

The DN7100 handles all the communications management administrative functions, and as a consequence, the interface between the DN7100 and the DPS 7 is transport-to-session, respectively.

The System Communications Facility (SCF) makes use of the task management and the buffer management, provided by the Distributed Network Supervisor (DNS), to handle all connections to and from the network.

The principal components of DN7100 software operated on by SCF, are

- . Links Management
- . Terminal Manager
- . and, Transport and Routing Management Services.

Links Management

Links Management implements the data link layer and is composed of the following modules

- . TSV, which manages the MLC and detects all connection requests over the network
- . and, DCS (Data Communications System), which handles all transmission procedures except TTY, and which provides the "entry" to SCF by activating it.

Terminal Manager

The terminal manager is in charge of all terminal connections and is composed of the following modules

- . Asynchronous Terminal Support, for local TTY terminals connected over switched networks
- . Synchronous Terminal Support, for local terminals using line procedures other than TTY, connected over leased lines
- . PAD Terminal Support, for PAD terminals of the TRANSPAC network, which uses the functions of the Asynchronous Terminal Support and X25L3
- . and, CSX Terminal Support, for CSX25 terminals of the TRANSPAC network, which uses the functions of the Synchronous Terminal Support, X25L3 and the DSA transport station.

Transport and Routing Management Services

These are two separate but interdependent services which function as follows

- . DSA transport station, for implementing the transport layer
- . and, both Network Routing Management (NR Mgt) and X25L3, for implementing the network layer.

The DSA transport station performs the following

- . synchronizes the transport stations
- . establishes the transport connection
- . multiplexes several transport connection over the virtual circuit
- . disassembles letters and assembles fragments
- . and, regulates data traffic through the transport connection.

NR Mgt manages all network connection requests, except for the local network, while X25L3 performs the following

- . synchronizes the DN7100 with the TRANSPAC switcher
- . establishes the virtual circuit
- . assembles X25 messages from X25 packets, and vice versa
- . and, controls the flow of data over the virtual circuits.

FUNCTIONAL DESCRIPTION OF FNPS

Three GCOS service jobs manage the DPS 7 interface with the DN7100, namely

- . the FNPS "transport" service for the "run-time" communications session
- . and, ADM functioning with the NASF "file server" for executing service functions on the DN7100, see pages 2-08 and 2-11.

FNPS functions with DNS, the system software of the DN7100. The network control command "MTF fsys-name AUTO", where "fsys-name" identifies the DN7100,

- . loads the DN7100
- . and, starts up FNPS.

The functions of FNPS are performed by a mono-process load module H_FNPS which is partitioned into four principal modules

- . the transport module, TPM
- . the events manager, TPMEVT
- . the administrative function, ADCOM
- . and, the I/O driver, PIO.

Transport Module (TPM)

The TPM is composed of three functions

- . the VCAM interface which uses session control procedures to dialog with VCAM
- . "pseudo-transport" management which provides the transport "extension" from the DN7100 to the DPS 7, see the diagram on the facing page
- . and, the logical channel handler which
 - multiplexes different connections over plug numbers of the destinations
 - selects the channel and asks PIO to execute I/O over the channel
 - and, performs I/O operations through channel program management.

In addition, TPM performs the task of setting the watchdog timer to ascertain if the DN7100 is still active.

In the case of the DN7100 connection, the transport layer is handled by the DN7100 while the DPS 7 provides the "pseudo-transport" which the TPM manages, see page 1-07.

"Pseudo-transport" involves extending the "connection" from the subchannel (SBC) to the plug (PLG). The extension is effected through the "port" of the I/O controller operating over a physical channel of the PSI connecting the DN7100.

Instead of the logical connection being adjacent to the transport connection, as is the case in the URP connection, "pseudo-transport" is interposed between the two connections, cf. page 1-18.

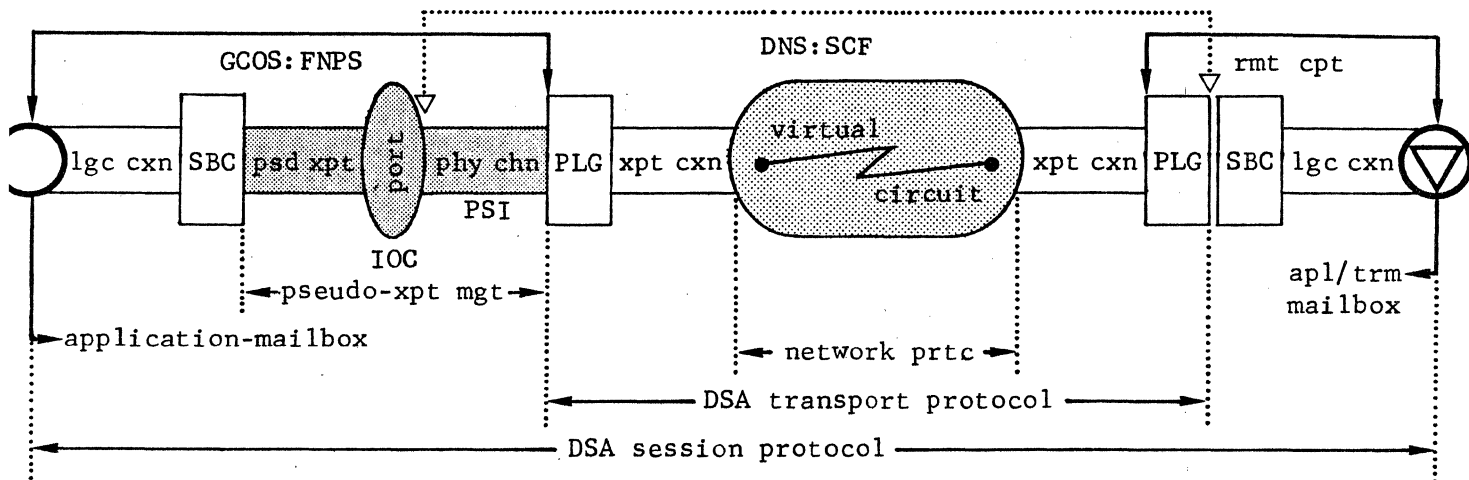

The logical channel is the path over which a channel program can be executed independently of the others. Several logical channels can be handled over a single physical channel.

Physical channels are numbered in the PSI, and are categorized according to their use, namely,

- . command or control channels, being hardware configured as follows
 - channel 0, to receive DN7100 status changes and service function requests
 - channel 1, to transmit commands from the DN7100 to the DPS 7
 - channel 2, to transmit commands from the DPS 7 to the DN7100
- . and, data channels, which are firmware defined in the SRST at installation, and software configured through the following FNP parameters at network generation
 - the total number of I/O channels (n) is defined for CCnn, being the SRST external identifier of the associated DN7100
 - the number of I/O channels (s) for SIRIS is defined in MODE, therefore making the number of I/O channels available for "native" mode equal to (n - s)
 - and, out of the total number of (n - s) I/O channels available for "native" mode, the number of channels to be used exclusively for input is defined in INCLNB.

For further details, refer to the Network Generation Manual.

The numbering of input data channels starts at 3, the next being 4 and so on. The numbering of output data channels starts at n, the maximum being 16, the next being (n - 1) or 15, and so on.

The following explanation only deals with the function of the DPS 7 in passing data to a remote correspondent, and vice versa, through the intermediary of the DN7100.

Events Manager (TPMEVT)

The TPMEVT is composed of "exit" routines for each DN7100 configured to the DPS 7, for dealing with all incidents occurring in FNPS, such as

- . the termination of the channel program initiated by the logical channel handler
- . and, the termination of FNPS itself.

The "exit" routine is specific to the incident and, if an anomaly has occurred, the appropriate message is displayed on the network control terminal, see message CC14 of the Network Control Operations Manual.

Anomalies are generally the result of I/O errors, an FNPS abort or parameters of the CNC generation being in conflict with those of the DN7100 "sysgen" declaration.

Administrative Function (ADCOM)

The ADCOM handles the administration of FNPS, namely

- ★ . processes administrative commands, such as "TT fnp-name"
- . initializes the channel program for the logical channel handler
- . and, requests the "common" system buffer pool manager for preallocation of space, and, dynamically frees used segments when no longer required.

The "common" system buffer pool manager operates on the I/O buffers declared in the FNP command at network generation, that is, for input, INBFSZ and INBFNB, and for output, OUTBFSZ and OUTBFNB. The manager is decentralized since it functions for both FNPS and VCAM, and as a result, is not contained within FNPS.

I/O Driver (PIO)

The PIO handles all operations over the channels, namely

- . enables TPM to receive "attention" notifications over command channel 0
- . transmits commands from the DN7100 to the DPS 7 over command channel 1
- . transmits commands from the DPS 7 to the DN7100 over command channel 2
- . and, allows input and output exchanges over the data channels.

SECTION V

DISTRIBUTED SYSTEMS ADMINISTRATION AND CONTROL

Distributed Systems Administration and Control (DSAC) is a component of DSA. It is implemented on the DPS 7 as a load-module H_DSAC and as a set of system modules.

DSAC provides services throughout the primary network, which allow

- any system to send a command to another system for execution and to receive the resultant response
- any event occurring within the network to be reported to all participating systems
- and, the participating system to journalize all or some of these events on logfiles either located locally, that is, on the system itself, or on other remote systems.

The command sent from a system can be entered either by the operator as a local network control command or through an administrative utility (AUT) using the Administrative Utility Programmatic Interface (AUPI).

The response as the result of the execution of the command contains the command itself and is treated as an event to be sent over the network.

The event, such as the opening of the session, a physical line error or statistics associated with a virtual circuit, is transited over the network as an unsolicited message to be journalized on the logfiles.

The unsolicited message is vehiculed as a record of specific format and content using the Administrative Exchange Protocol (AEP). The AEP governs the exchange of such records between a NAD on the one hand and its correspondent on the other hand.

The NAD, node administrative facility, is the active DSAC component and must be present in all participating systems.

The correspondent of the NAD can be

- a network control center (NCC), a network operator interface (NOI)
- an AUT or an administrative storage facility (ASF).

The logfiles are a set of files circularly used to journalize unsolicited messages in the form of the AEP record. The contents of these logfiles may be processed either by the logfile editor (H_LFE), a GCOS utility, or an AUT using AUPI.

AUPI is a set of system modules which allow AUTs to process administrative traffic generated by correspondents of the network.

DSAC Services
Commands and Responses

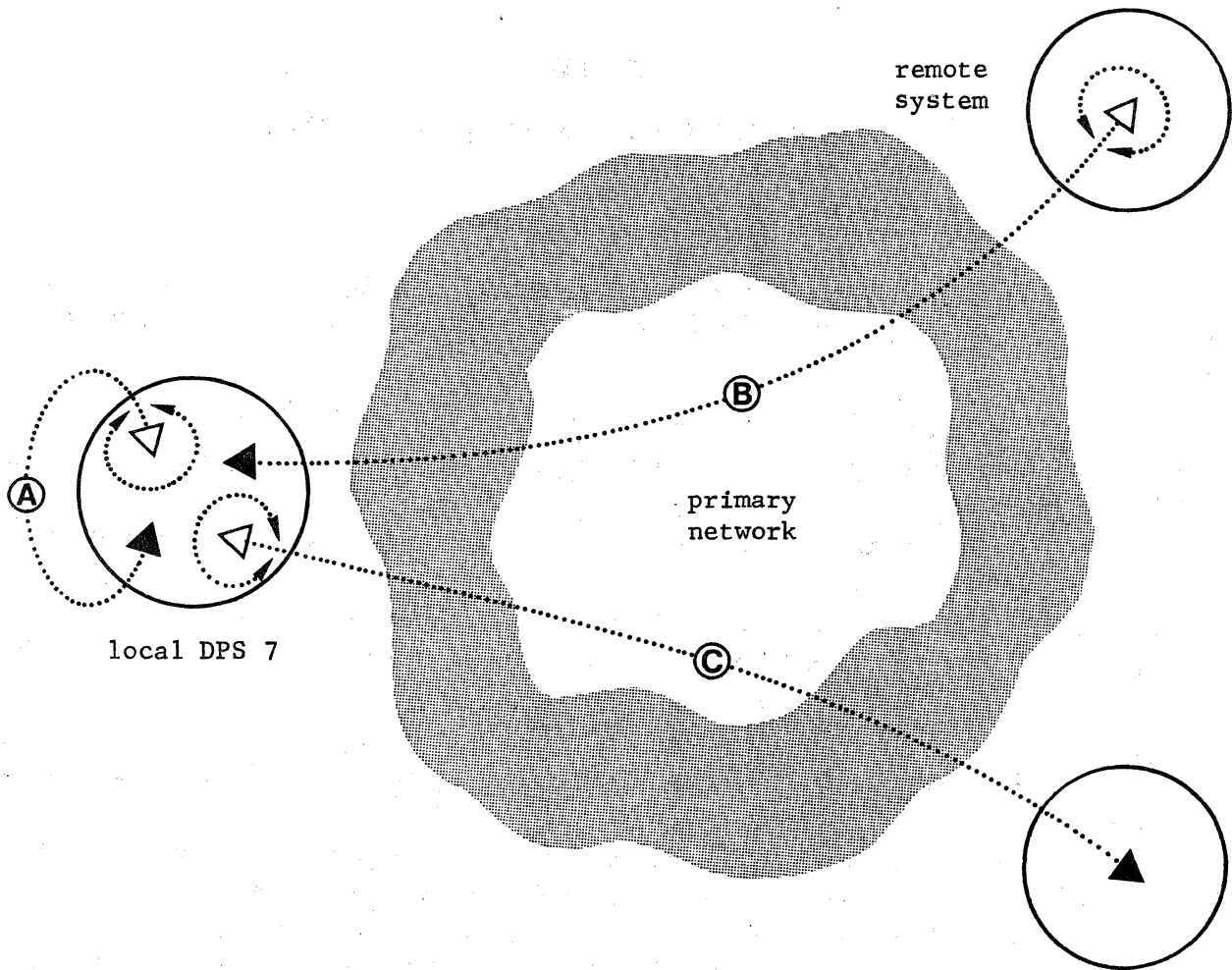

1. command
2. execution of the command
3. response : result of an executed command or command submission

For Release GCOS7 V2, B is not currently supported.

- A) launching and executing commands on the local system, and receiving the responses on the local system
- B) launching commands from the local system, executing commands on the remote system, and receiving the responses on the local system
- C) launching commands from a remote system, executing commands on the local system, and sending the responses to the remote system.

Note : The front-end processor of the local DPS 7, if present, is a particular case of a remote system.

DSAC Services
Journalization

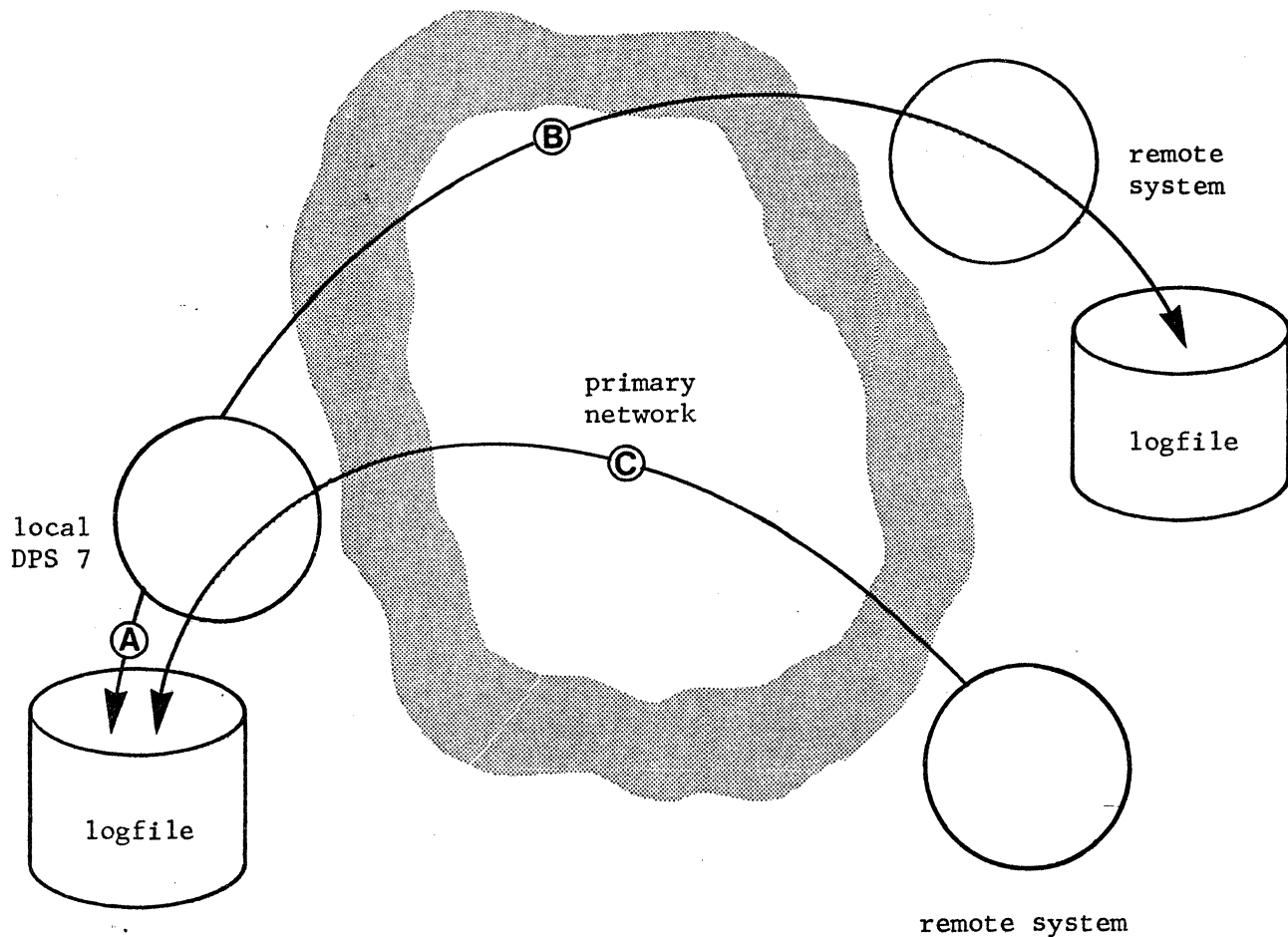

← direction of unsolicited messages

Note : An event occurring throughout the network, in any of the participating systems, is reported as an unsolicited message in the form of an AEP record.

- A) journalization of events occurring in the local DPS 7 on the logfiles of the DPS 7 itself
- B) journalization of events occurring in the local DPS 7 on the logfiles of a remote system
- C) journalization of events occurring in a remote system on the logfiles of the local DPS 7.

DSAC OBJECTS

The names of the DSAC objects appear in the equivalent CNC commands for generating them in the DSAC configuration.

The 5 DSAC objects which make up the configuration are

- . AF - administrative function, the active component of DSAC addressed by 1 or more mailboxes through which sessions with ACs are established
- . AC - administrative correspondent, the direct correspondent of the AF having homologous attributes as the AF and, in most cases, being the image of another AF
- . AG - administrative group, a set of similar or complementary ACs having common attributes and functions
- . FL - "administrative" filter, associated with ACs, AGs and LGs, for determining if a particular AEP record is to be allowed through
- . LG - "administrative" log, for providing the AF with the storage facilities for AEP records coming from ACs.

When CNC is executed, it builds up a set of objects with attributes either implicitly defined by DSAC or explicitly declared by the user. These objects reflect the resources of the configuration and its intended use during the DSAC session.

When the DSAC session is started up, these objects provide the relational links to each other for administrative traffic to flow among them.

DSAC Objects
Administrative Functions

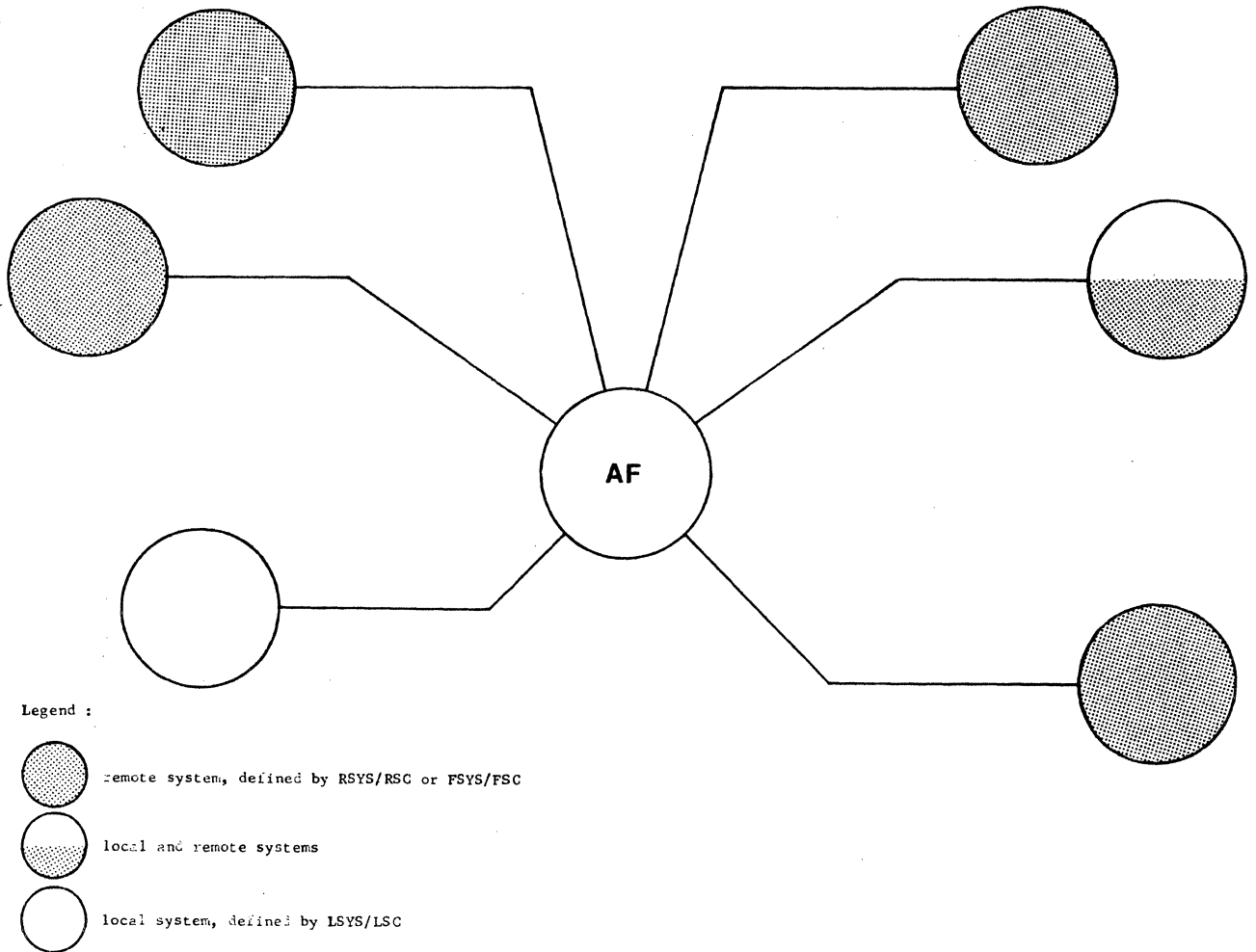

The term AF is strictly reserved for an administrative function resident in the local DPS 7 declaring its DSAC configuration.

There is no global DSAC configuration but a configuration of each system with respect to the others.

The AF and its correspondents are

- either "coresident" if the correspondent resides in the same local system
- or "non-coresident" if the correspondent resides in a remote system.

The front-end system, in the DSAC context, is a particular case of a remote system.

DSAC Objects
Administrative Correspondents

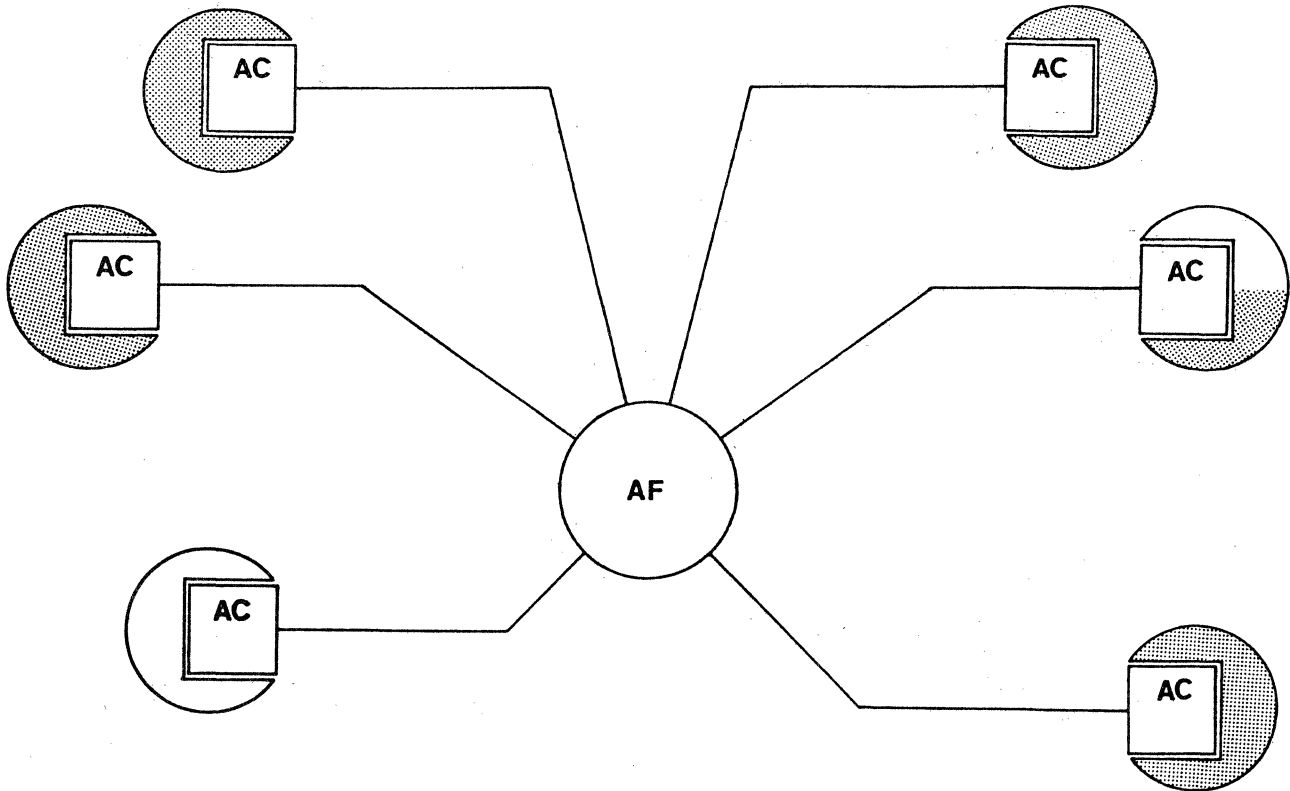

Legend :

AF : local DPS 7 declaring the DSAC configuration
AC : DPS 6
 DN7100
 DPS 7

All administrative functions which communicate with a given local AF, whether "co-resident" or "non-co-resident" with it, are its administrative correspondents or ACs.

ACs are created according to their purpose and function

- either statically through the associated AC command explicitly defined by the user
- or dynamically by DSAC, as the need to establish administrative connections involving them arises.

All effective communication between the "non-co-resident" AC and its AF passes via DSA sessions between their respective mailboxes.

Since the AC is a correspondent throughout the network, its mailbox address takes the DSA format <session-name><mailbox-name>. The names of both parameters are defined in the AC command.

DSAC Objects
Administrative Groups

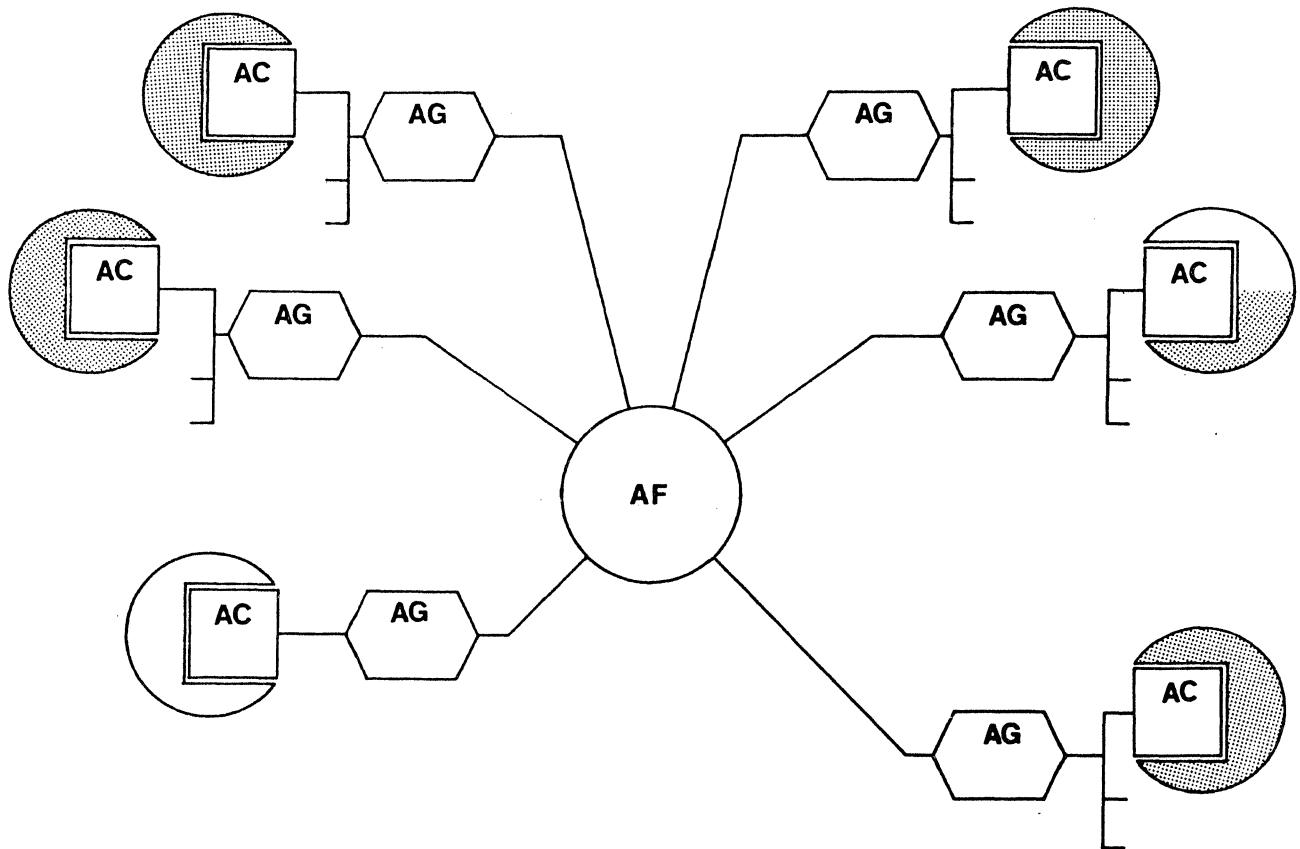

Several ACs residing in different systems can

- share the same functional attributes, such as correspondent type
- use the same filter(s)
- and, connect to the same AF mailbox.

Instead of repeating these parameters common to each of the ACs, a convenient way is to declare such parameters once for a common "grouping" of ACs.

This common "grouping" or AG (administrative group) is therefore to be considered as the logical extension of each AC belonging to it.

The AF-AC connection is established between their mailboxes defined respectively

- in the AG command, on the one hand
- and, in the AC command, on the other hand.

Where the AC is dynamically created, the only user-visibility of such an AC in the DSAC configuration is its associated AG.

DSAC Objects
Administrative Filters

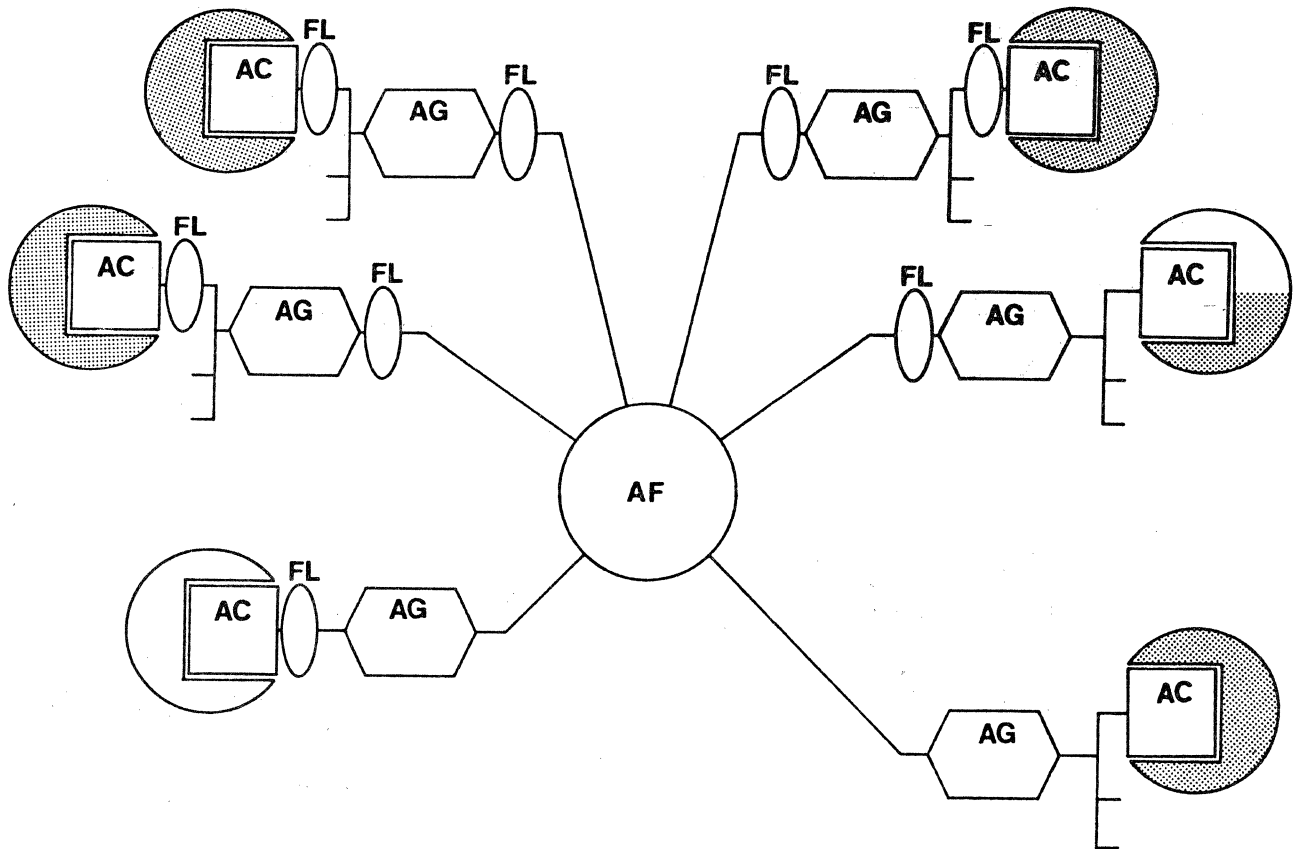

Some method is required to regulate the flow of administrative traffic through the AF-AC "conduit" in either or both directions, whichever condition applies.

Administrative traffic passes in the form of the AEP record whose header contains filtering parameters which provide the basis on which the record can be selected or rejected.

The administrative filter or FL specifies filtering criteria which are used to match against the filtering parameters present in the AEP record header. The selection of the record then depends on the match and the "logic" of the filter.

The FL is defined either "input" towards the AF or "output" towards the AC.

The FL which is an element in the relationship between the AF and its AC, is "owned" by

- . either the AG whose filtering criteria apply to all ACs belonging to it
- . or the AC whose filtering criteria, if "enabled", override those specified for its associated AG.

The AC which is dynamically created, cannot be declared by the user and therefore must have its FL attached to its associated AG.

DSAC Objects
Administrative Logs

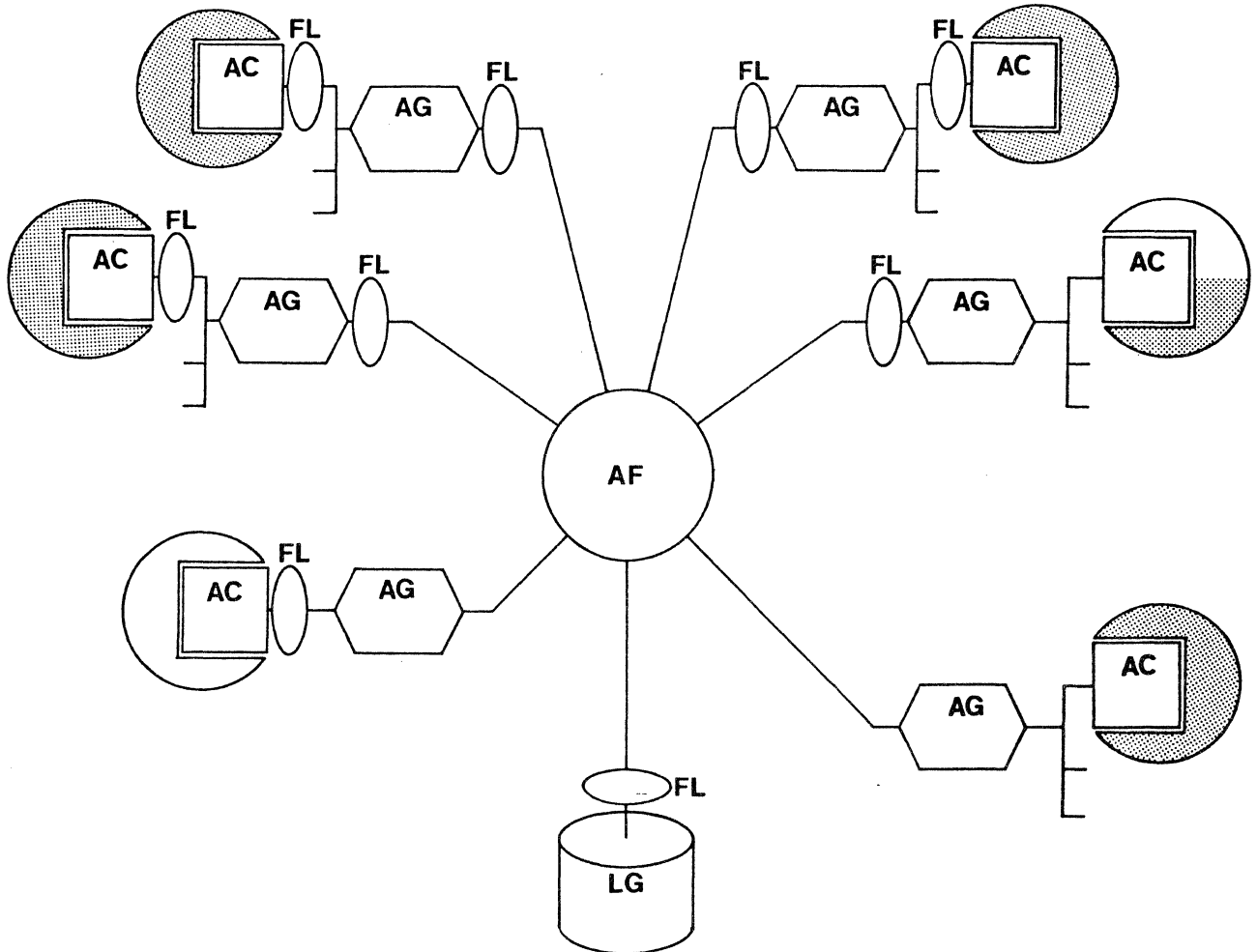

The administrative log or LG represents a set of logfiles used by the AF for journalization.

The LG provides the storage facilities for events occurring in the DPS 7 and throughout the network.

The LG is a particular case of a "coresident" correspondent.

The connection between the LG and its AF is established through the file management mechanism of the DPS 7.

Since the LG receives traffic, its associated FL can only be "one-way" towards itself, that is, "output" from the AF.

The AF uses the logfiles on a circular basis, switching from one logfile to the next consecutive one.

CORRESPONDENT TYPES

The correspondent type determines how its associated object is to function and what service it is to provide.

The 5 correspondent types are

- . NAD - node administrative facility, required in each participant of the DSAC configuration and is responsible for taking the appropriate control actions within the "node" and reporting its local events to the external environment
- . ASF - administrative storage facility, provides the capability of storing AEP records in the local system and transiting them to remote systems, through logfile management and administrative libraries
- . NOI - network operator interface, supports operator and/or administrator connections to a set of NADs or AUTs, and translates Control Language statements to/from AEP format
- . NCC - network control center, contains a mandatory NOI and is composed of AUTs attached to it through the AEP or across a local programmatic interface (AUPI)
- . AUT - administrative utility, a batch or real-time application using DSAC services; a user-defined AUT uses AUPI.

Overview of Correspondent Types

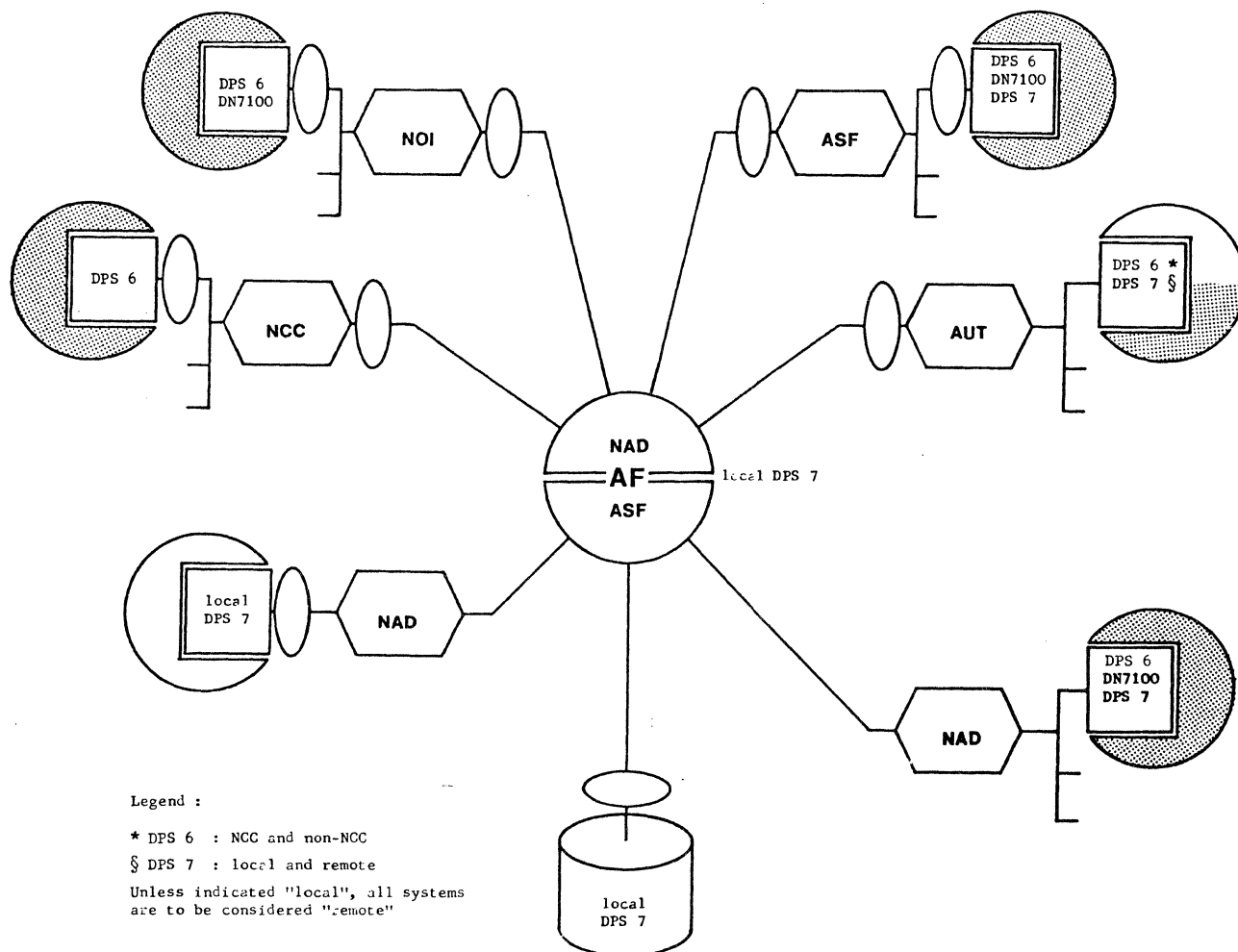

Each correspondent type performs specific functions. In the current release, the AF in the local DPS 7 performs the functions of NAD and ASF.

Connections between the correspondent types are shown for some of the different systems that make up the DSAC environment of the DPS 7.

The systems that appear in the DSAC configuration, are those known to CNC through the PROFILE parameter of their respective RSYS commands. LSYS and FSYS "profiles" are subsets of RSYS "profiles".

Not all configured systems implement the functions of all the correspondent types.

There is no logical or operational reason why all participating systems of the DSAC configuration should not fully implement all the functions.

This is a limitation imposed on the system by its current state of software development and not a DSAC architectural restriction.

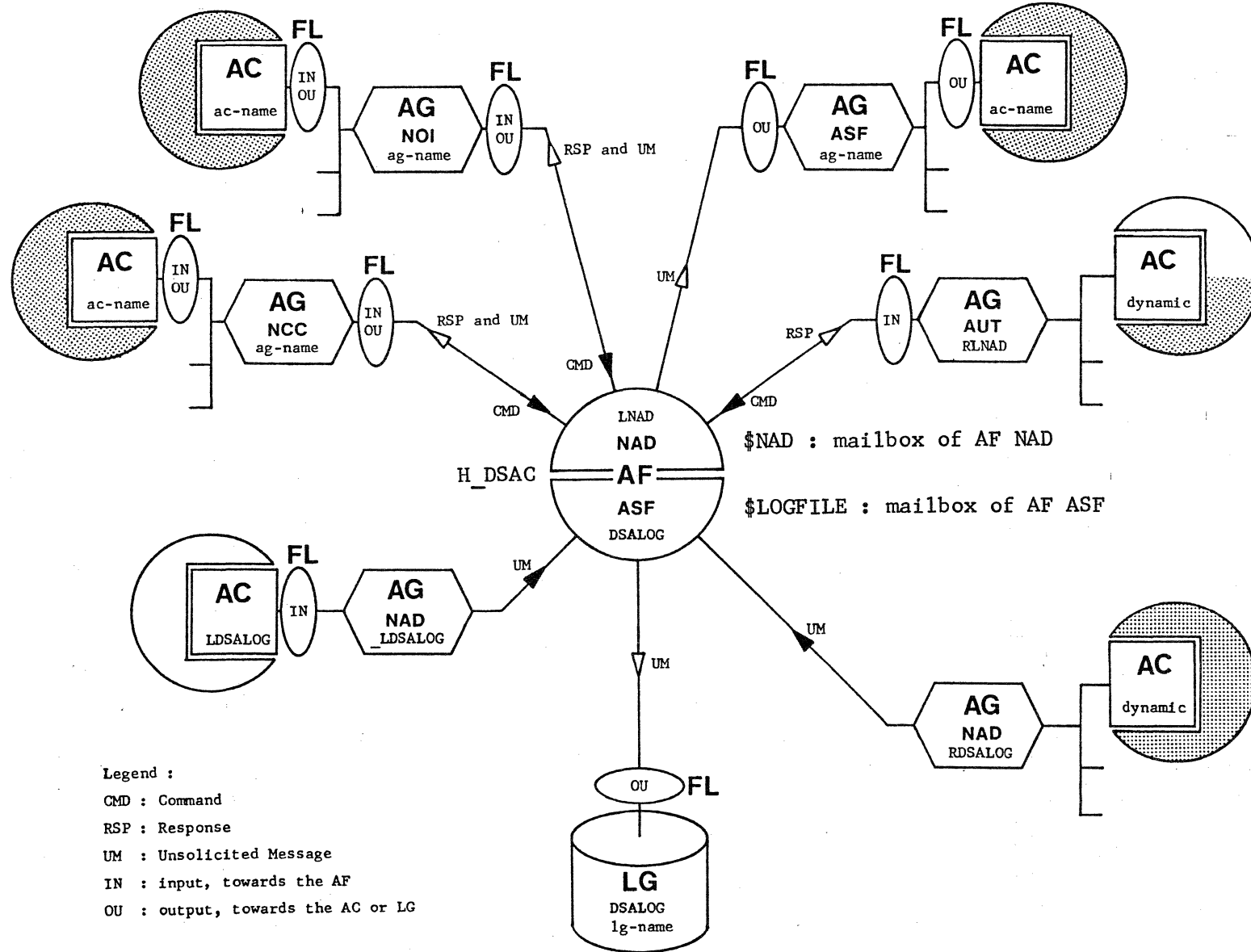

OVERVIEW OF DSAC IMPLEMENTATION

The administration and control of distributed systems depend on the flow of information between participants of the network. Each participant is therefore aware of any event happening in its counterparts throughout the network, and can consequently take effective measures.

DSAC is implemented by the DPS 7 in terms of

- . connections to its NAD (AF LNAD)
- . and, connections to its ASF (AF DSALOG).

Connections to AF LNAD

The AF LNAD has the system-reserved mailbox \$NAD. It is a unique occurrence whose state is always "enabled".

Correspondents of LNAD can be an NCG, NOI, AUT or AC ASF.

LNAD interacts with its correspondents as follows,

- . receives CMDs from the NCG, NOI and AUT
- . takes the appropriate control actions, and sends back the resultant RSPs to the respective originators of the CMDs
- . and, informs the NCG, NOI and AC ASF of events occurring in the local system.

AUT is the only correspondent which is dynamically created.

Connections to AF DSALOG

The AF DSALOG has the system-reserved mailbox \$LOGFILE. It is a unique occurrence.

Its state can be altered by the operator from "enabled" to "locked", and vice versa. "Locking" DSALOG merely stops the journalization of UMs.

DSALOG provides the DPS 7 with DSAC storage facilities, as follows,

- . receives UMs from AC NADs, both local and remote
- . and, journalizes these UMs on the set(s) of logfiles associated with the LG.

The "non-coresident" correspondents of DSALOG are remote NADs which are dynamically created.

JOURNALIZATION

There are 2 sets of logfiles, each of which are composed of up to 9 UFAS files,

- the mandatory SYS.DSALOGi set
- and, the optional user-defined SYS.<lg-name>i set.

Journalization consists of 2 activities, namely

- local journalization which involves the DPS 7 logging on its set(s) of logfiles, UMs produced not only by itself but also UMs produced by remote NADs
- and, remote journalization which involves the DPS 7 sending only the UMs it produces to the remote ACs to be logged by their storage facilities.

Local Journalization

AF DSALOG receives UMs and RSPs from the local NAD (AC LDSALOG) and from remote NADs (dynamic ACs of AG RDSALOG).

AF DSALOG stores this administrative data on its set(s) of logfiles.

UMs from LDSALOG represent events occurring in the local DPS 7 and can be filtered before being sent to AF DSALOG. An internal interface between AF DSALOG and AF LNAD allows these UMs to transit to the remote ACs.

UMs from RDSALOG are not sent to remote ACs.

If any NCC, NOI or AC ASF connect to the local DPS 7, UMs from LDSALOG are transited to them and stored unfiltered at the same time on the mandatory set of logfiles SYS.DSALOGi.

Filters associated with these logfiles are ignored. The UMs sent to the remote ACs are therefore a facsimile of those stored on SYS.DSALOGi.

When all remote ACs to which UMs are sent, disconnect, the filters associated with SYS.DSALOGi are once again taken into account.

Whether remote ACs connect or not, UMs can be filtered and stored only on the optional user-defined set of logfiles SYS.<lg-name>i.

Remote Journalization

Remote journalization involves the transit of UMs generated by the local NAD (AC LDSALOG) to the NCC, NOI and AC ASF, when they connect to the local DPS 7.

UMs from LDSALOG include the results of the submission and execution of CMDs sent to AF LNAD by the NCC, NOI and AUTs.

While the originator of the CMD receives the RSP, the NCC, NOI and AC ASF eventually receive the same information vehicled as a UM, when their filters accept such records.

Whatever affects local journalization also affects remote journalization. If either AF DSALOG or LDSALOG is "locked", UMs are no longer sent to the remote ACs.

Since the AF LNAD continues to function in the meanwhile, all events occurring in the local DPS 7 are not recorded and are therefore "lost".

Schema
 of
 Journalization

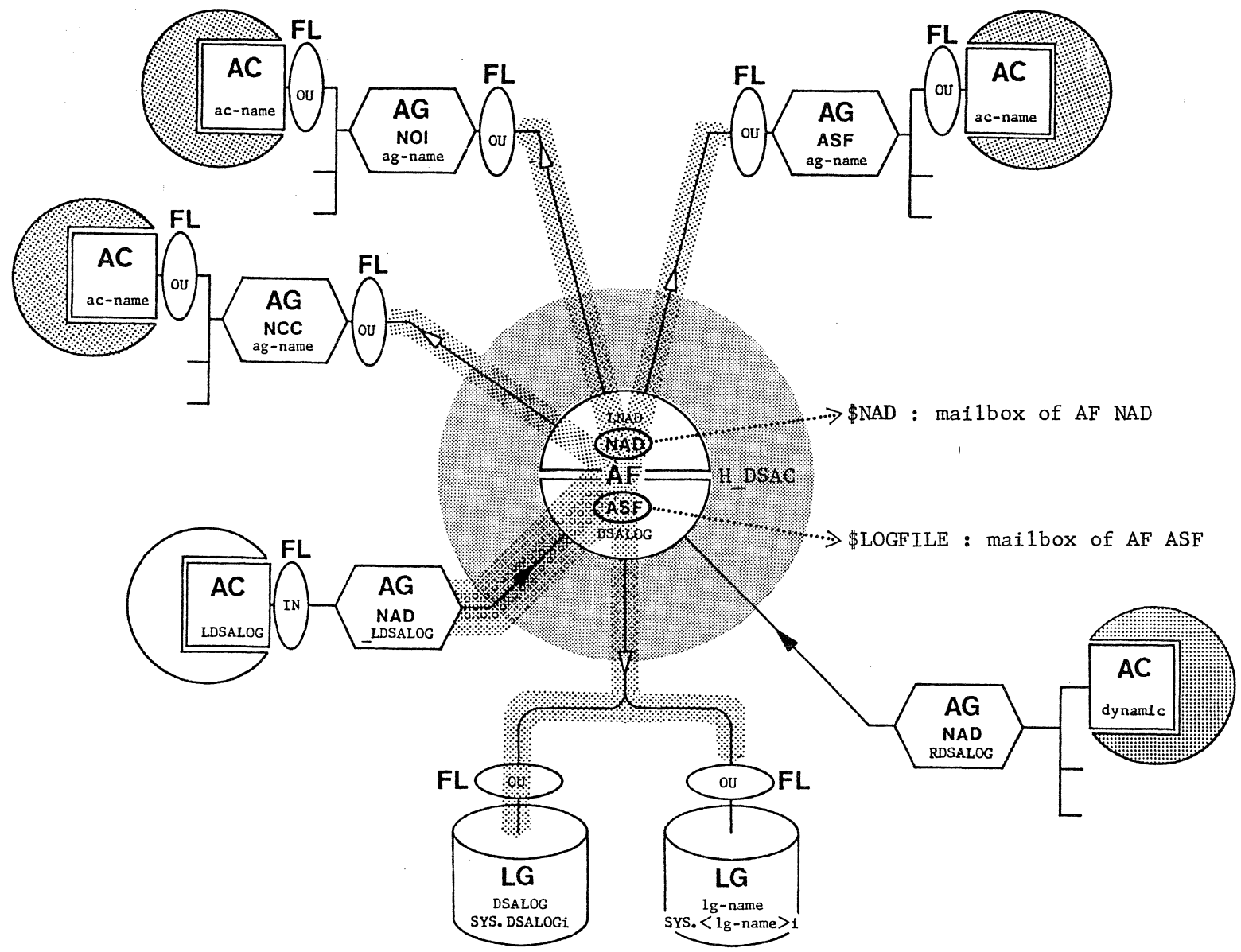

Use of Filters during Journalization

All journalization is based on the entry of UMs generated by the local NAD (AC LDSALOG).

Before being sent to the AF DSALOG, these UMs can be filtered by LDSALOG itself.

Once AF DSALOG receives the UM from LDSALOG, it dispatches the UM to

- both the mandatory SYS.DSALOGi logfiles and the optional user-defined logfile set SYS.<lg-name>i, if present
- and, NCC, NOI and AC ASF, if any of these remote ACs connect to the local DPS 7.

Filters associated with SYS.DSALOGi logfiles operate as follows

- they are effective for UMs coming from LDSALOG provided that no remote ACs connect to the local DPS 7 (AF LNAD)
- however, they remain effective for UMs coming from remote NADs (AG RDSALOG) whether remote ACs connect or not.

Filters associated with SYS.<lg-name>i logfiles remain effective whatever the origin of the UM and whether remote ACs connect to the AF LNAD or not.

OPERATING THE DSAC SESSION

The 5 network control commands for operating the DSAC session are

- . ST DSAC, for starting the session
- . TT DSAC, for terminating the session
- . HT <object-name>, for "locking" the object
- . RT <object-name>, for "enabling" the object
- . and, DT <object-name> [<parameters>], for displaying the status of the object.

The DSAC session is started up after the communications session is started up because the transport connections between the DPS 7 and its remote systems must first be activated before the administrative connections between them can be established.

Journalization begins once the DSAC session is started up. The management of the logfiles and the flow control of administrative traffic during journalization are monitored through network control messages displayed to the operator.

All DSAC objects declared in the configuration are either "enabled" or "locked". As far as the user is concerned, these are the only declarable and alterable states. Depending on the requirements of the DSAC environment, the operator can dynamically alter the state of the object before the start of, and during the DSAC session.

The HT and RT commands respectively "locking" and "enabling" the object, do not need the DSAC session to be started up, to be effective.

However, during the course of the DSAC session, the system itself can dynamically alter the state of the object to that previously set either in its CNC state or, subsequently, by the operator.

The operator can actively monitor the status of the object through DT commands.

The status of the object comprises its state, its correspondent type and its association with its correspondent.

Not all error conditions require operator intervention. For example, although the operator is informed of a temporary overflow situation, the system takes its own recovery actions.

Error conditions which require operator intervention, are denoted in the message.

The DSAC session is terminated before the shutdown of the communications session.

ADMINISTRATIVE UTILITIES PROGRAMMATIC INTERFACE

AUPI is the programming interface for utilities which process administrative data of a DSA network.

AUPI enables the user through the AUT to connect

- . to any system, local or remote, to issue commands for execution, and to receive the resultant responses
- . to the LG object of the local DPS 7, in order to obtain "on-line" information on statistics, events and command responses, as they happen
- . and, to the set of logfiles for the same information as above, but "off-line", the logfile being processed as any file in batch mode.

AUPI is implemented as a set of call procedures, each using its specific data structure(s). AUPI is available in COBOL and GPL.

It conforms to applicable DSA standards and allows

- . the simplification of AEP encoding techniques by providing the user a high-level view of this protocol
- . and, user-defined AUTs to be independent of changes in the structure and form of the AEP.

For further information, see the AUPI User Guide.

Schematic Overview
of
AUI

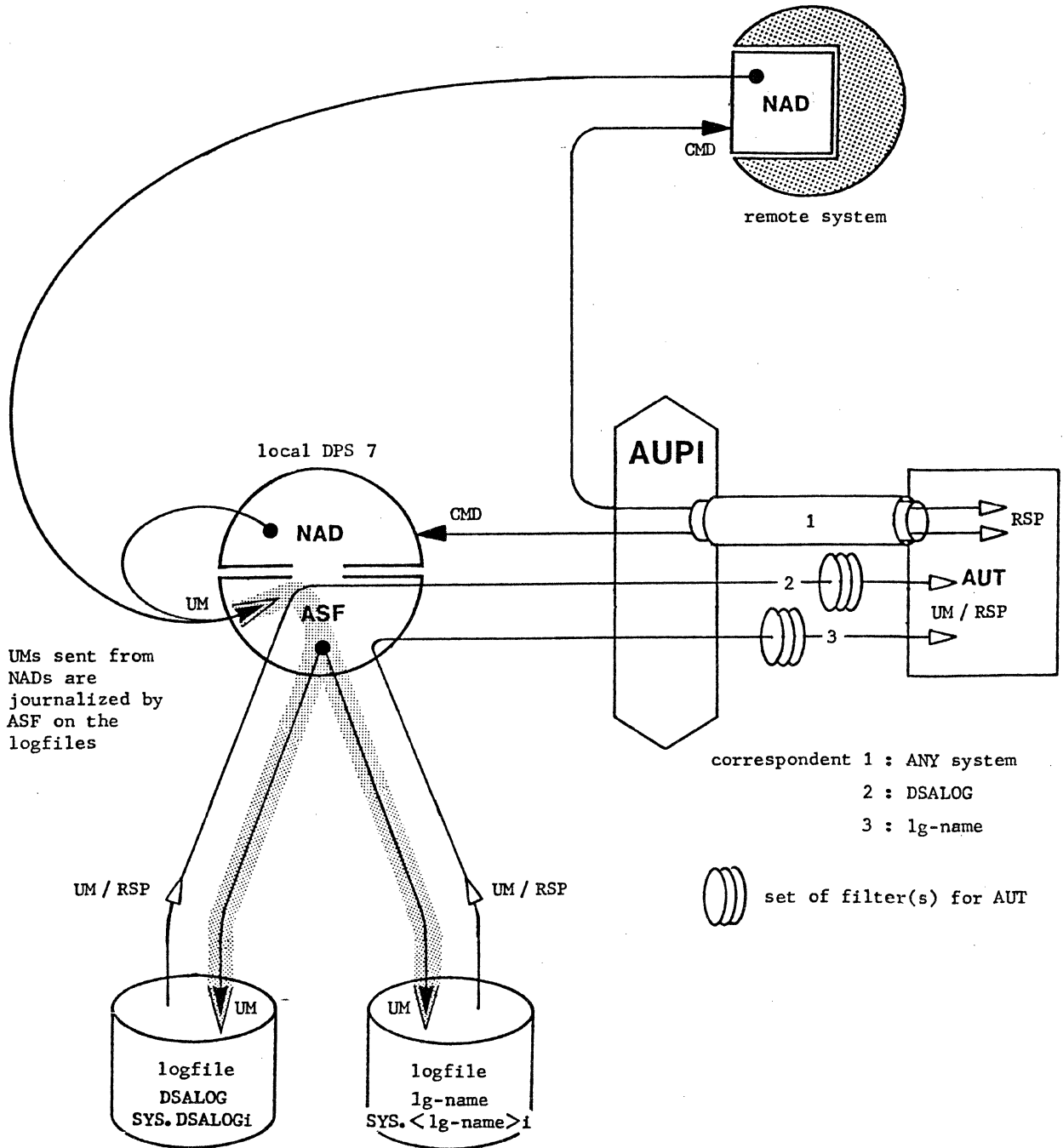

BASIC NETWORK SESSION EXERCIZER

BNSE is a tool for testing the session and application layers between two systems in a DSA-300 network.

It operates on the basis of one system being the "initiator" and the other being the "acceptor". The session is established between the mailboxes of both systems under test. The subsequent transfer of data during the test session, does not disrupt normal network traffic.

BNSE is implemented as a packaged product.

It is started as a job through the SJ console command, in which parameters for the job execution are entered.

In the facing diagram, the local DPS 7 is shown dialoging with two remote systems using the default mailboxes of the respective "initiator" and "acceptor" tests.

For further information, see the DSAC User Guide.

Schematic Overview
of
BNSE

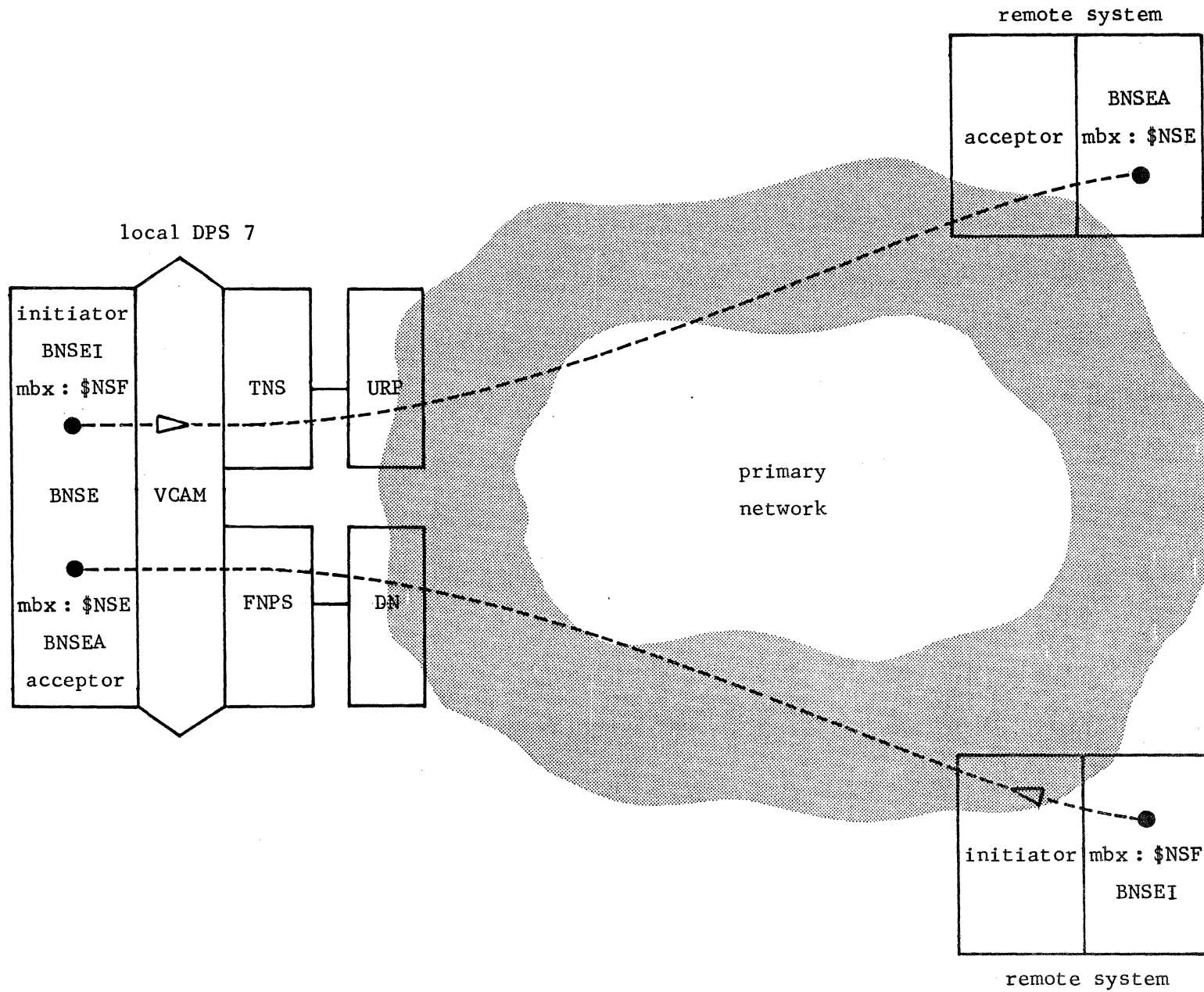

APPENDIX A

ACCESS OVER TRANSPAC

TRANSPAC is the X25 packet-switching public network available in France. The two types of subscriptions that can be taken out with the PTT are

- either the packet mode for connecting the DPS 7 to the TRANSPAC network
- or the character mode for connecting a TTY terminal via the PAD service to the DPS 7.

An explanation of how to complete the subscription form and the relationship between the entries and their associated CNC parameters are given in the Network Control Operations Manual.

DESCRIPTION OF THE TRANSPAC NETWORK

The TRANSPAC network is a set of switches, each one being duplicated with a "back-up" switch, interconnected by high-speed HDLC lines. It is the common carrier of the French PTT, which provides virtual circuits of the X25 packet-switching network.

A subscriber is any correspondent of the network, being

- . either a terminal or a cluster of terminals in a secondary network
- . or a system, being a central processor, in a primary network.

The HDLC line which connects these correspondents can be either medium speed (2400 bps) or high speed (48000 bps) depending on the throughput required.

The link protocol over the TRANSPAC network uses the HDLC line procedure. Systems that transmit in the HDLC line procedure, and terminals attached to "controllers" that adapt to the HDLC line procedure, can connect directly over TRANSPAC.

Telex and Teletype terminals must use the PAD (packet assembler/disassembler) service that adapts their TTY line procedure to the HDLC line procedure, to connect to TRANSPAC. Asynchronous TTY lines operate at low speed.

All correspondents connect to a switch which acts

- . either as a "shunt" to directly establish the "link-up"
- . or as a "relay" through other switches before establishing the "link-up".

The correspondent is unaware of the mechanism of the "link-up". What the correspondent is aware of, is the access to the destination required.

Schematic Representation
of the
TRANSPAC Network

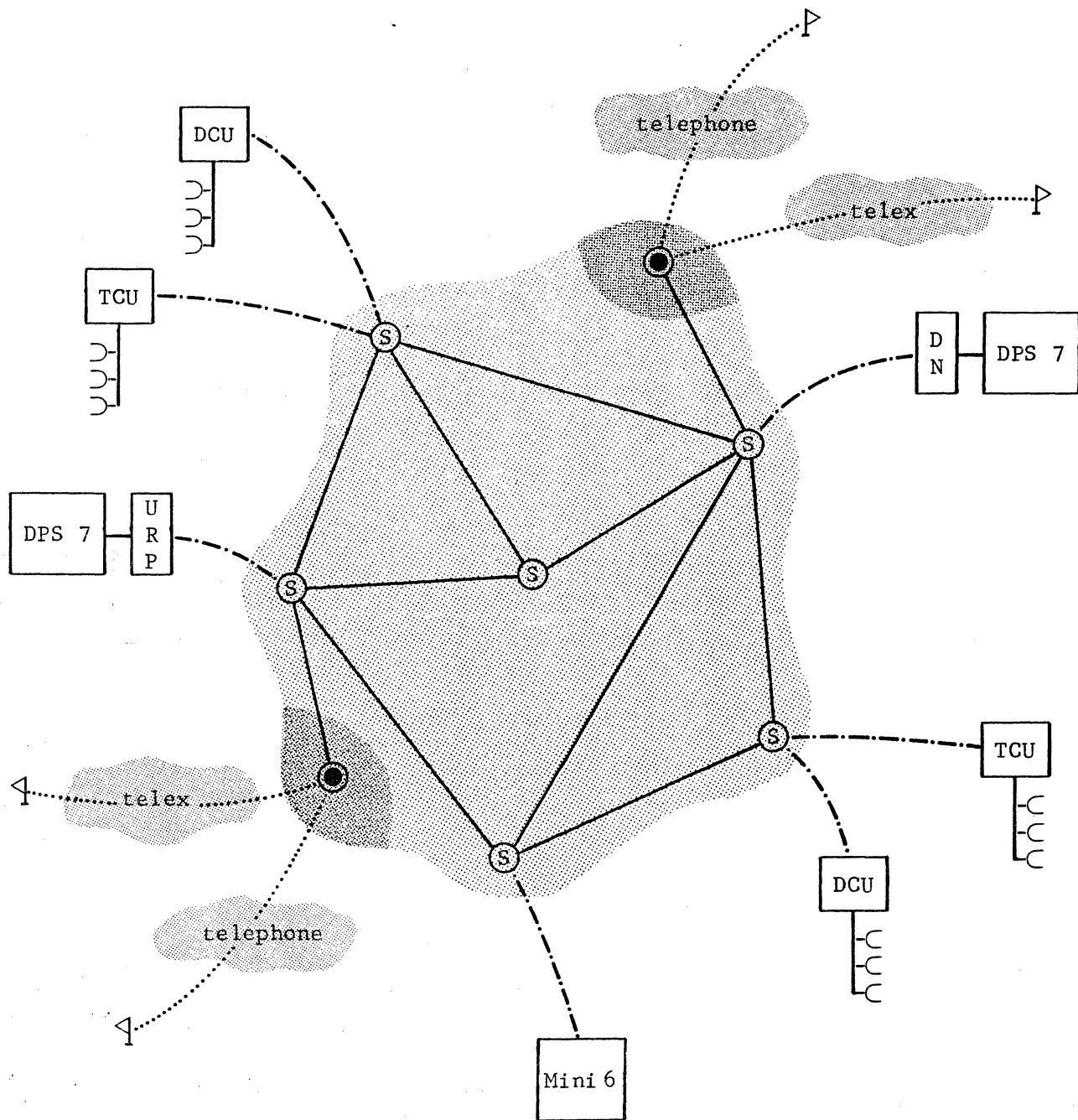

Virtual Circuits

Communications between two subscribers is handled over a virtual circuit provided by TRANSPAC.

The virtual circuit establishes the logical path between the subscribers, over which one or more network routes defined by the user, are mapped.

The effective throughput of the virtual circuit is determined by the user through the following attributes specified by their respective parameters

- . speed of transmission specified by the LINESPEED parameter at URP firmware generation
- . packet size which fixes the size of the packet to be exchanged, specified by the PKSIZE parameter of the LSUB command at CNC generation
- . and, the authorized anticipation, being the maximum number of packets that the subscriber may send before TRANSPAC acknowledges the first packet transmitted, specified by the WINDOW parameter of the LSUB command.

While these parameter values may differ for communicating subscribers, TRANSPAC ensures that the lower value relevant to the exchange transmission between any two subscribers at a time is selected for consistency and compatibility.

A virtual circuit is established through the exchange of control packets conforming to the TRANSPAC connection protocol.

Once the connection is established, the virtual circuit is set up over a physical path linking the subscribers through a series of switches. The physical path need not necessarily be the same between two subscribers. TRANSPAC "routes" the virtual circuit through available switches most expedient to the current transmission. The subscriber, however, is unaware of the mechanism of this "routing".

The virtual circuit may be

- . either permanent, where the pvc is permanently available, in which case, the pvc must be declared in the CNC generation by the command sequence PVC - RDTE - RDTN following the LSUB command
- . or switched, where the svc is made available only on request, in which case, the user visibility of the svc's is restricted to the SILIN, SOLIN and SLINE parameters of the LSUB command to indicate respectively
 - the number of svc's dedicated to inward calls
 - the number of svc's dedicated to outward calls
 - and, the number of "general-purpose" svc's for inward and outward calls.

The rules governing the physical path over which the virtual circuit is set up are as follows

- . the path once set up remains unchanged until the virtual circuit disconnects, with the result that packets exchanged over the virtual circuit will follow the same consecutive order at emission, as at reception
- . in the case of a switch failure when the path has already been set up and before the virtual circuit disconnects, an alternative physical path is automatically set up and packets already transmitted over the previous path will be retransmitted over the current path to preserve and maintain their consecutive order
- . and, the choice of the physical path depends on the resources reserved in each switch to cater for the speed of transmission and the authorized anticipation.

Subscriber and Subscription

A subscriber, being any correspondent, is a TRANSPAC user identified within the network by a "dial-up" subscription number which can be either a 7-digit telephone number or a number of up to 15 digits known specifically to TRANSPAC.

The subscription number is declared in the appropriate CNC command(s) depending on the subscriber

- . if the subscriber is a terminal declared by the RDTN command, the subnb is declared as the argument of the SUBNB parameter of the preceding RDTE command
- . if the subscriber is a system declared by the RSYS - RSC command sequence, two subnb's are required to establish the link-up between the "local system" and the rsys, as follows
 - for the lsys :
 - . the "local subnb" is declared as the argument of the SUBNB parameter of the LSUB command
 - . and, the name of the LSUB command is declared as the argument of the SUBSCRID parameter of the CP command defining the communications path between the lsys and the rsys
 - for the rsys :
 - . the "remote subnb" is declared as the argument of the ADDR parameter of the RTS command which defines the "arrival" transport station of the rsys.

The subnb is an addressing parameter which allows one subscriber to call up another and which is associated with the following attributes

- . the number and characteristics of the virtual circuits available
- . and, the physical X25 HDLC link(s) interposed between the subscriber and its associated switch.

The logical connection between two subscribers can be maintained through different links according to the availability of the intervening switches. The higher the performance requirements, the more virtual circuits are needed to support the logical connection. As a consequence, a subscriber taking out several TRANSPAC subscriptions and declaring several network routes per subscription, over which the virtual circuits are mapped, can maintain a high transmission throughput by enabling different access points to different categories of remote subscribers.

However, the hardware constraint imposed by the network is that the failure of a switch and its backup makes unavailable all the subscriptions linked to it. The way to get around this constraint is to open a backup subscription which uses a different switch. It is highly improbable that both switches and their backups can fail simultaneously.

Packets and Packet-Switching

The packet is the unit of information transported over the virtual circuit and contains control information concerning X25 protocols, used by TRANSPAC to manage the virtual circuits, such as

- . routing information being the reference for the packets following
- . the rank of the packet within the X25 message to which it pertains, determining the order of the packet in relation to its succession
- . acknowledgement information
- . the amount of information transported in the packet, thereby determining the size of the packet
- . and, the type of packet which determines the purpose of the information transported, whether for control or as user data.

The relationship of control information to data information is illustrated by the contents of the "request logical connection" ILCRL which is generated in the session layer to set up the logical connection over the virtual circuit, as follows

- . at the level of the session layer, the contents is control information
- . however, at the level of the TRANSPAC network, the contents is data information since the purpose of the packet is unknown to TRANSPAC which acts solely as a "conveyancing" agent.

The packet size within TRANSPAC is one of 32, 64, 128 or 256 bytes, exclusive of any control information that is added en route. If the packet size is not declared in the PKSIZE parameter of the LSUB command, TRANSPAC takes as default a packet size of 128 bytes.

TRANSPAC uses the packet-switching technique. A user message or MUX data fragment sent over a virtual circuit is split into packets. The last packet, though not completely filled, has to conform to the same fixed length as determined at connection time, as the rest of the preceding packets.

On the receiver side of the virtual circuit, the packets are received in the same order as sent, and, being physically adjacent and logically consecutive, can be immediately reassembled into the X25 message. The X25 message, in turn, is reconstituted into either the user message or a MUX data fragment.

The X25 or DSA transport station is responsible for

- . managing the virtual circuit
- . assembling packets into letters on reception
- . and, disassembling letters into packets for emission.

The advantages of the packet-switching technique are

- . reliability of transmission since the message is broken down into packets, and, error detection being at the level of the packet, a sequence of packets and not the entire message need be retransmitted
- . high throughput performance of the network since the switches are linked through high speed X25 HDLC lines and since the routing of the virtual circuit is dynamically selected according to the immediate availability of the switches.

Features of the Packet-Switching Network

The following are the principal features of TRANSPAC

- . the error rate tends to be low since any error is detected at the level of the packet whose size, even at a maximum of 256 bytes, is relatively small in comparison to the average message, and, therefore, the error is recovered on retransmitting the packet and not until the entire message is sent
- . easy memory management at switch level is due to pre-determining the size of the packet thereby enabling simple fixed algorithms to be applied to allocate memory resources
- . since the unit of transmission is the packet, any subscriber, with enough information to fill a packet, can immediately start transmitting, although at the time of the transmission, the letter has yet to be completed
- . while the subscriber is restricted to a pre-determined packet size, the same virtual circuit can transmit packets of differing sizes between subscribers, each declared with its own packet size to compensate for transmission at different speeds.

PAD Service

The PAD service enables asynchronous TTY terminals to connect to the TRANSPAC network by providing them the means of generating and receiving packets using the HDLC line procedure over either switched or leased lines.

It manages the local dialog in order for the subscriber to set up the virtual circuit.

An asynchronous terminal connected to PAD is declared at network generation by

- . the keyword PAD in the RDTE command
- . and, the type DTU7171, TTU8124, TTU8126 or TTU8128 in the following RDTN command.

Since the PAD terminal is seen as a mono-virtual circuit subscriber by TRANSPAC, each terminal is declared by a pair-set of CNC commands RDTE - RDTN on a 1-for-1 declaration.

By contrast, in the case of a CSX25 terminal, being either VIP or QUESTAR, it is its "controller" which is seen as a mono-virtual circuit subscriber by TRANSPAC. The "controller" which is declared by the keyword CSX25 in the RDTE command, can therefore be followed by several RDTN commands representing the terminals associated with it.

Vos remarques sur ce document / Technical publications remarks form

Titre / Title : _____
DATA COMMUNICATIONS DPS 7 GCOS 7 Communications Processing Facility
Volume 1 : Communications Overview

N° Référence / Reference No. : _____
47 A2 01UC REV1

Date / Dated : _____
July 1985

ERREURS DETECTEES / ERRORS IN PUBLICATION

AMELIORATIONS SUGGEREES / SUGGESTIONS FOR IMPROVEMENT TO PUBLICATION

1.14 p.

- ▶ Vos remarques et suggestions seront attentivement examinées.
Si vous désirez une réponse écrite, veuillez indiquer ci-après votre adresse postale complète.
- ▶ Your comments will be promptly investigated by qualified technical personnel and action will be taken as required.
If you require a written reply, furnish your complete mailing address below.

NOM/NAME : _____
SOCIETE/COMPANY : _____
ADRESSE/ADDRESS : _____

DATE : _____

- Remettez cet imprimé à un responsable BULL ou envoyez le directement à :
- Please give this technical publications remarks form to your BULL representative or mail to :

Distribution codes/Codes de diffusion				
Customers :	SCS3000D	_____	_____	_____
Clients :	*	*	*	*
_____	_____	_____	_____	_____
Internal :	47310000	_____	_____	_____
Interne :	*	*	*	*

DELIVERY ADDRESS
ETIQUETTE ADRESSE

Bull Systèmes

94, Av. Gambetta
75990 PARIS Cedex 20



47A201UC 01



Systèmes