

VMS Workstation Software User's Guide

Order Number: AA-EZ24D-TE

June 1989

The *VMS Workstation Software User's Guide* provides information about running Version 4.1 of VMS Workstation Software on a VAX workstation.

Revision/Update Information: This manual supersedes the *VMS Workstation User's Guide*, available when VWS V4.1 was released (Order Number AA-EZ24D-TE).

Software Version: For systems running VMS Version 5.0 and above.

Digital Equipment Corporation

June 1989

The information in this document is subject to change without notice and should not be construed as a commitment by Digital Equipment Corporation. Digital Equipment Corporation assumes no responsibility for any errors that may appear in this document.

The software described in this document is furnished under a license and may be used or copied only in accordance with the terms of such license.

No responsibility is assumed for the use or reliability of software on equipment that is not supplied by Digital Equipment Corporation or its affiliated companies.

Copyright ©1989 by Digital Equipment Corporation

All Rights Reserved.
Printed in U.S.A.

The postpaid **READER'S COMMENTS** form on the last page of this document requests the user's critical evaluation to assist in preparing future documentation.

The following are trademarks of Digital Equipment Corporation:

DEC	DIBOL	UNIBUS
DEC/CMS	EduSystem	VAX
DEC/MMS	IAS	VAXcluster
DECnet	MASSBUS	VMS
DECsystem-10	PDP	VT
DECSYSTEM-20	PDT	
DECUS	RSTS	
DECwriter	RSX	

This document was prepared using VAX DOCUMENT, Version 1.1

Update Notice 1

VMS Workstation Software User's Guide

Order Number: AD-EZ24D-T1

June 1989

NEW INFORMATION

This update contains changes to the *VMS Workstation Software User's Guide*, AA-EZ24D-TE.

Digital Equipment Corporation

INSTRUCTIONS

The enclosed pages are to be placed in the *VMS Workstation Software User's Guide* as replacements for or additions to the current pages. On replacement pages, changes and additions are indicated by vertical bars (|).

Keep this notice in your manual to maintain an up-to-date record of changes.

Copyright Digital Equipment Corporation 1989
All Rights Reserved.
Printed in U.S.A.

Old Page(s)	New Page(s)
Title/Copyright	Title/Copyright
iii/iv through xi/xii	iii/iv through xi/xii
1-3/1-4	1-3/1-4 through 1-4.1/blank
2-5/2-6 through 2-11/2-12	2-5/2-6 through 2-12.1/blank
2-25/blank	2-25/blank
B-1/B-2 through B-23/B-24	B-1/B-2 through B-37/B-38
Index-1/Index-2 through Index-5/blank	Index-1/Index-2 through Index-5/blank
Reader's Comments/Mailer	

Contents

PREFACE	xi
<hr/>	
CHAPTER 1 GETTING STARTED	1-1
1.1 WINDOWS	1-1
1.2 THE GETTING STARTED WINDOW	1-2
1.3 MENUS	1-3
1.4 THE POINTER AND POINTING DEVICES	1-4
1.4.1 Using Pointing Devices	1-4
1.4.2 Using the Mouse	1-4.1
1.4.2.1 Using the Keyboard Instead of the Mouse • 1-5	
1.4.3 Using the Tablet Subsystem	1-5
1.4.3.1 Using the Puck • 1-7	
1.4.3.2 Using the Stylus • 1-7	
1.5 FUNCTION KEYS	1-7
1.6 THE OPERATOR WINDOW	1-9
1.6.1 Using the Operator Window	1-9
1.6.2 Operator Window Functions on Color and Intensity Systems	1-9
<hr/>	
CHAPTER 2 THE WORKSTATION OPTIONS MENU	2-1
2.1 OBTAINING HELP	2-2
2.2 VT220 TERMINAL EMULATION	2-3
2.3 TEKTRONIX 4010/4014 TERMINAL EMULATION	2-4

Contents

2.4	PRINTING A PORTION OF THE SCREEN DISPLAY	2-5
2.4.1	Changing Print Destination _____	2-6
<hr/>		
2.5	WORKSTATION SETUP MENU	2-7
2.5.1	Automatic Login _____	2-8
2.5.1.1	Side Effects of Automatic Login • 2-8	
2.5.2	Color Display Setup _____	2-9
2.5.2.1	Standard Color Setup on Monochrome (Bitonal) Systems • 2-9	
2.5.2.2	Standard Color Setup on Intensity Systems • 2-11	
2.5.2.3	Standard Color Setup on Color Systems • 2-11	
2.5.3	Keyboard Setup _____	2-12
2.5.4	Pointer Setup _____	2-14
2.5.5	Preferred Color Setup _____	2-14
2.5.5.1	Preferred Color Setup on Monochrome (Bitonal) Systems • 2-15	
2.5.5.2	Preferred Color Setup on Intensity Systems • 2-15	
2.5.5.3	Preferred Color Setup on Color Systems • 2-16	
2.5.6	Printer Setup _____	2-16
2.5.7	Screen Saver Period _____	2-18
2.5.8	Tektronix 4010/4014 Terminal Attributes _____	2-18
2.5.9	VT220 Terminal Attributes _____	2-19
2.5.10	Workstation Type _____	2-22
2.5.11	Use Default Settings _____	2-22
2.5.12	Restore Last Saved Settings _____	2-22
2.5.13	Save the Current Settings _____	2-22
2.5.14	Exit This Menu _____	2-23
<hr/>		
2.6	DISABLING THE WORKSTATION SETUP OPTIONS MENU ATTRIBUTES	2-23
<hr/>		
2.7	MODIFYING THE WORKSTATION OPTIONS MENU ATTRIBUTES	2-24
<hr/>		
CHAPTER 3	USING WINDOWS	3-1
<hr/>		
3.1	LOGGING ON TO A TERMINAL-EMULATOR WINDOW	3-1
<hr/>		
3.2	WINDOW OPTIONS MENU	3-4
3.2.1	Push behind _____	3-5
3.2.2	Pop in front _____	3-5

3.2.3	Delete	3-5
3.2.4	Change the size	3-5
3.2.5	Shrink to an icon	3-6
3.2.6	Additional Options	3-8
3.2.7	Exit From This Menu	3-8
<hr/>		
3.3	CYCLING THE KEYBOARD	3-8
<hr/>		
3.4	MOVING A WINDOW	3-9
<hr/>		
3.5	CHANGING WINDOW SIZE WITH DCL	3-9
<hr/>		
3.6	COPYING AND PASTING BETWEEN TERMINAL-EMULATOR WINDOWS	3-9
3.6.1	Description	3-9
3.6.2	Transparent Mode	3-10
3.6.3	Programmed Mode	3-10
3.6.4	Human Interface	3-10
3.6.5	Button Operation	3-10
3.6.6	Paste Buffer Format	3-12
3.6.7	Paste Operation	3-12

**APPENDIX A VAXSTATION SUPPORT FOR TEKTRONIX 4010/4014
TERMINALS** A-1

A.1	IMPLEMENTATION	A-1
<hr/>		
A.2	IMPLEMENTATION RESTRICTIONS	A-1
<hr/>		
A.3	SCREEN ADDRESSING	A-2
<hr/>		
A.4	SETUP SUPPORT	A-2
<hr/>		
A.5	ASCII CHARACTER CODES	A-2
<hr/>		
A.6	ESCAPE SEQUENCES	A-10

Contents

A.6.1	Ignored Escape Sequences _____	A-10
A.6.2	Request Terminal Status _____	A-10
A.6.3	Select Bypass Condition _____	A-11
A.6.4	Set Alpha Mode _____	A-11
A.6.5	Set GIN Mode _____	A-11
A.6.6	Select Point Plot Mode _____	A-11
A.6.7	Select Character Size _____	A-11
A.6.8	Select Vector Patterns _____	A-12
A.6.9	Set LCE Flag _____	A-12
A.6.10	Delete Character _____	A-13
A.6.11	Miscellaneous Escape Sequences _____	A-13
<hr/>		
A.7	CHANGING OPERATIONAL MODES	A-14
<hr/>		
A.8	CLEARING THE SCREEN	A-15
<hr/>		
A.9	BYPASS CONDITION	A-15
<hr/>		
A.10	ALPHA MODE	A-16
A.10.1	Margin Processing _____	A-16
A.10.2	Character Size _____	A-17
<hr/>		
A.11	GRAPH MODE	A-17
A.11.1	Line Patterns _____	A-17
A.11.2	Drawing Command _____	A-18
A.11.3	Encoding Coordinates _____	A-18
<hr/>		
A.12	POINT PLOT MODE	A-19
<hr/>		
A.13	GRAPHICS INPUT MODE	A-20

APPENDIX B ADDITIONAL FEATURES OF THE VT220 TERMINAL EMULATOR B-1

B.1	OPTIONAL WAYS TO MODIFY VT220 TERMINAL EMULATOR FEATURES	B-1
B.1.1	Redefining VT220-Emulator Logical Names _____	B-1

B.1.2	Creating and Invoking Escape Sequences _____	B-10
B.1.3	Operating System Command (OSC) Strings _____	B-11
B.1.4	Control Sequence Introducer Strings _____	B-20
B.1.5	ANSI Color Text SGRs _____	B-23
B.1.6	Device Control Sequences _____	B-24
B.1.7	Locator Input for VWS Terminals _____	B-26
	B.1.7.1 ANSI Locator (mouse/tablet) Input • B-26	
	B.1.7.2 Locator Input Model • B-26	
	B.1.7.2.1 Enabling Locator Reporting • B-26	
	B.1.7.2.2 DECELR—Digital Enable Locator Reports • B-27	
	B.1.7.2.3 Locator Position Reporting • B-27	
	B.1.7.2.4 Filter Rectangles • B-28	
	B.1.7.2.5 Selecting Locator Events • B-29	
	B.1.7.2.6 Requesting a Locator Position Report • B-29	
	B.1.7.3 Locator Device Support • B-30	
B.1.8	VWS VT200 Terminal Emulation Copy and Paste _____	B-30
	B.1.8.1 Description: • B-31	
	B.1.8.1.1 Human Interface (Transparent Mode) • B-31	
	B.1.8.1.2 Button Operation • B-31	
	B.1.8.1.3 Copy Operations • B-32	
	B.1.8.1.4 Paste Operations • B-32	
	B.1.8.2 Programmed Mode • B-33	
	B.1.8.2.1 Copy Operations • B-33	
	B.1.8.2.2 Paste Operations • B-33	
	B.1.8.3 Terminal Sequences • B-34	

B.2	REGIS IMPLEMENTATION	B-36
------------	-----------------------------	-------------

B.3	VWS TERMINAL MAILBOX MESSAGES	B-36
------------	--------------------------------------	-------------

APPENDIX C	COMPOSE SEQUENCES	C-1
-------------------	--------------------------	------------

C.1	COMPOSING CHARACTERS	C-1
	C.1.1 Three-Stroke Compose Sequences _____	C-1
	C.1.2 Two-Stroke Sequences _____	C-2
	C.1.3 Aborting or Restarting a Compose Sequence _____	C-3

C.2	COMPOSE SEQUENCE TABLES	C-3
------------	--------------------------------	------------

Contents

APPENDIX D	NATIONAL KEYBOARDS FOR VT220 EMULATION	D-1
------------	--	-----

APPENDIX E	SYSTEMWIDE LOGICAL NAMES	E-1
------------	--------------------------	-----

INDEX

FIGURES

1-1	Terminal-Emulator Window	1-2
1-2	The Getting Started Window	1-3
1-3	The Workstation Options Menu	1-4
1-4	Mouse SELECT Button	1-5
1-5	The Tablet Subsystem	1-6
1-6	The Puck	1-7
1-7	The Stylus	1-7
2-1	Workstation Options Menu	2-1
2-2	Workstation Options Menu with HELP Selected	2-2
2-3	VT220 Terminal-Emulator Window	2-3
2-4	Selected Screen Print Area	2-6
2-5	Workstation Setup Menu	2-7
2-6	Display-Background Setup for Monochrome (Bitonal) System	2-10
2-7	Window-Background Setup for Intensity System	2-11
2-8	Pointer-Foreground Setup for Color System	2-12
3-1	VT220 Emulator Window with User Name Prompt	3-2
3-2	Menu icon on Window Banner	3-3
3-3	Banner with KB Icon, Black on White, for Attached Keyboard	3-4
3-4	Banner with KB Icon, White on Black, for Unattached Keyboard	3-4
3-5	Window Options Menu	3-5
3-6	Terminal Emulator Icon	3-7
A-1	Tektronix Operating Modes	A-15
B-1	Standard Mailbox Message Format	B-37
B-2	Format for RESIZE Message	B-38
B-3	Format for MOVE Message	B-38
D-1	North American Keyboard	D-2
D-2	British Keyboard	D-3
D-3	Flemish-Belgian Keyboard	D-4
D-4	Canadian-French Keyboard	D-5
D-5	Danish LK201_AD Keyboard	D-6
D-6	Danish LK201_ED Keyboard	D-7
D-7	Finnish Keyboard	D-8
D-8	French Keyboard	D-9

D-9	German Keyboard _____	D-10
D-10	Dutch Keyboard _____	D-11
D-11	Italian Keyboard _____	D-12
D-12	Norwegian LK201_AN Keyboard _____	D-13
D-13	Norwegian LK201_EN Keyboard _____	D-14
D-14	Spanish Keyboard _____	D-15
D-15	Swedish Keyboard _____	D-16
D-16	Swiss-French Keyboard _____	D-17
D-17	Swiss-German Keyboard _____	D-18

TABLES

1-1	Key Combinations and Their Functions _____	1-5
2-1	VT220 Line-Editing Functions _____	2-4
2-2	VAXstation Supported Features _____	2-5
3-1	Buttons and Their Corresponding Functions _____	3-11
3-2	Logical Names, Functions, and Enabling DEFAULT Commands _____	3-11
A-1	7-Bit ASCII Codes _____	A-3
A-7	ASCII Character Code Functions _____	A-4
A-7	ASCII Character Code Functions _____	A-5
A-7	ASCII Character Code Functions _____	A-6
A-7	ASCII Character Code Functions _____	A-7
A-7	ASCII Character Code Functions _____	A-8
A-7	ASCII Character Code Functions _____	A-9
A-8	Escape Sequences Not Implemented in Tektronix 4010/4014 Terminal Emulation _____	A-10
A-9	Vector Patterns _____	A-12
A-10	LCE Flag Escape Sequences _____	A-13
A-11	Miscellaneous Escape Sequences _____	A-13
A-12	Line Patterns and Their Escape Sequences _____	A-18
A-13	Coordinate Encoding Byte Values _____	A-19
A-14	Shortened Address Capability Transmission Rules _____	A-19
B-1	VT220 Emulator Logical Names _____	B-2
B-2	ANSI Color Selections _____	B-8
B-3	Full Saturation for the Color System Defaults _____	B-8
B-4	Sample Increasing Gray Level Values for an Intensity System _____	B-9
B-5	VT220 Default Font Specifications _____	B-10
B-6	Function Codes and Their Meanings _____	B-12
B-7	Parameter Values and the Aspects They Change _____	B-23
B-8	Color Map Index and Corresponding Color _____	B-24
B-9	Locator Device Status Report (DSR) _____	B-30
B-10	Logical Names for SETUP _____	B-33
B-11	Message Events, Names, and Values _____	B-37
C-1	Diacritical Marks and Their Equivalent Characters _____	C-2
C-2	Compose Sequences for National Character Set Mode _____	C-3

Contents

C-3	Compose Sequences for Multinational Character Set Mode	C-7
E-1	Systemwide Logical Names by Facility	E-1

Preface

This guide describes how to use the VMS Workstation software. It is organized into three chapters and five appendixes as follows:

- Chapter 1 provides an overview of the workstation functions and introduces some of the terminology used in the guide.
- Chapter 2 describes the functions of the Workstation Options menu.
- Chapter 3 explains window-management tasks, such as creating, moving, and resizing windows.
- Appendix A describes VAXstation support for Tektronix 4010/4014 terminal emulation.
- Appendix B provides additional setup information for VT220 terminal emulation.
- Appendix C provides information on compose-character sequences, including tables for both the multinational and the national character sets.
- Appendix D illustrates the keyboard character configurations for the various languages supported by the VAXstation.
- Appendix E lists systemwide logical names.

The information in this guide assumes that both the VMS base system and the workstation software have been installed. See the appropriate VMS documentation for instructions on installing the base system. See the *VMS Workstation Software Installation Guide* for instructions on installing the workstation software. See also the *VMS Workstation Software Video Device Driver Manual*, the *VMS Workstation Software Guide to Printing Graphics*, and the *VMS Workstation Software Graphics Programming Guide*.

Unless otherwise noted, information in this guide refers to all three workstation types: monochrome (bitonal), intensity, and color. References to the SELECT button apply to the mouse, puck, and stylus.

Conventions Used In This Document

This manual uses the following conventions in displaying the syntax requirements of user input to the system and in displaying examples:

Conventions	Meaning
RETURN key	The RETURN key is not always shown in formats and examples. Assume that you must press RETURN after typing a command or other input to the system unless instructed otherwise.

Preface

Conventions	Meaning
<code>Return</code>	This symbology is used in the context of an interactive example and means that you should press the indicated key or combination of keys.
<code>CTRL/x</code>	CTRL followed by a slash followed by a letter means that you must type the letter while holding down the CTRL key. For example, CTRL/B means hold down the CTRL key and type the letter B.
Lists	When a format item is followed by a comma and an ellipsis (...), you can enter a single item or a number of those items separated by commas. When a format item is followed by a plus sign and an ellipsis (+ ...), you can enter a single item or a number of those items connected by plus signs. If you enter a list (more than one item), you must enclose the list in parentheses. A single item need not be enclosed in parentheses.
Optional Items	An item enclosed in square brackets ([]) is optional.
Angle Brackets	In examples, angle brackets enclose a syntactic element of user input, such as a key (<2>), a key sequence (<CTRL/Z>), or a parameter (<PASSWORD>).
Ellipsis	A vertical ellipsis indicates that some of the format or example is not included.
DELETE Key	The key on the VT200 series terminal keyboard that performs the DELETE function is labeled  .

Summary of New and Changed VAXstation Features

The following changes have been made for Version 4.1 of VMS Workstation Software and are reflected in this manual:

- Getting Started window—Now includes VWS version number and copyright information.
- Workstation Options menu—Now includes ability to choose the TEK4125 emulator window.
- TEK4125 window creation—Includes /INPUT = input-spec information necessary to create a TEK4125 window.

1

Getting Started

This chapter introduces the VMS Workstation software (VWS). It assumes that you have installed and started up VWS as described in the *VMS Workstation Software Installation Guide*.

This chapter describes the workstation environment. Read it before you use your system.

The information in this user's guide refers to three types of workstations:

- Monochrome (bitonal) system—Black and white
- Intensity system—Shades of grey
- Color system—Full color

Unless otherwise noted, all information in this user's guide applies to all three workstation types.

The following sections introduce some basic workstation concepts and terminology.

1.1

Windows

A *window* is a box on the screen you use to interact with the software. You can have several windows on the screen at the same time, each performing a different task. You can manage these windows in many ways, such as by moving, resizing, or reducing them to pictorial symbols called *icons*. You use windows to perform tasks such as the following:

- Display menus of options
- Display information such as status messages
- Provide an area for drawing objects

You can also create a window that emulates a terminal. These windows are called *terminal-emulator windows*. Two kinds of terminal-emulator windows are available:

VT220	Emulates the features of a physical VT220 terminal and keyboard.
Tektronix 4010/4014	Emulates the features of a physical Tektronix 4010/4014 terminal and keyboard.

You use terminal-emulator windows to log on, run applications, and perform other tasks that normally require a physical terminal.

Figure 1-1 shows a terminal-emulator window.

Getting Started

Figure 1-1 Terminal-Emulator Window

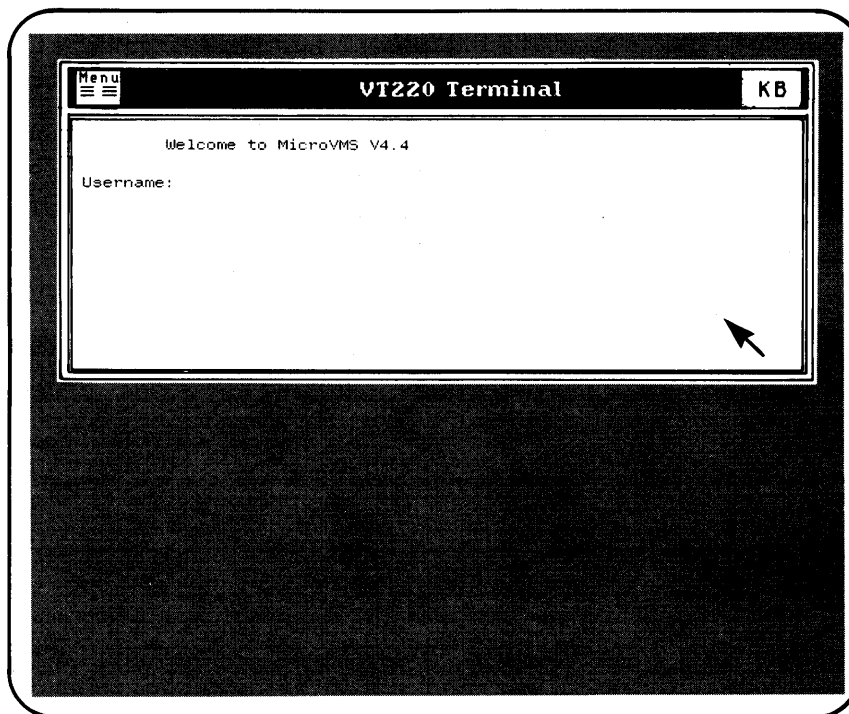

ZK-4054-85

1.2 The Getting Started Window

When no windows are on the screen, press any character, arrow, or keypad key to display the *Getting Started window*. Figure 1-2 shows the Getting Started window:

Figure 1-2 The Getting Started Window

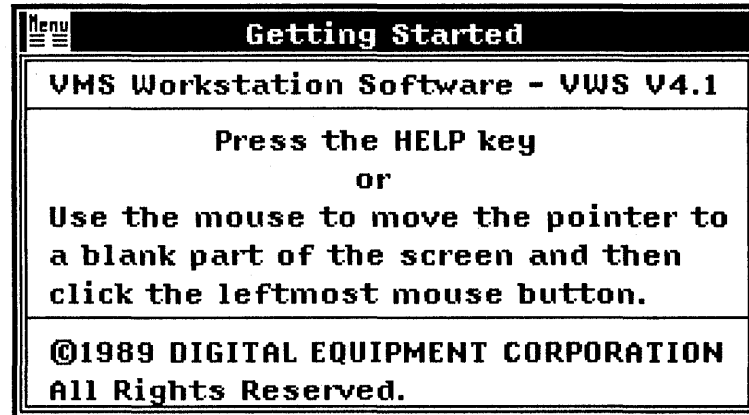

If you press **HELP** while the screen is blank, the Getting Started window appears on the screen and provides information about using the VAXstation features.

The Getting Started window gives instructions for using the mouse. If you follow the instructions, a window containing the Workstation Options menu appears on the screen.

1.3 Menus

A *workstation menu* lists options you can select to perform tasks. Some of the workstation menus you use are:

- Workstation Options—The *main menu*; it lists workstation functions you can invoke. Figure 1-3 illustrates the workstation options menu on the workstation screen.
- Window Options—Lists options for managing windows, such as popping one to the front of the display.
- Workstation Setup—Lists options for defining workstation setup attributes, such as color display setup.

Figure 1-3 The Workstation Options Menu

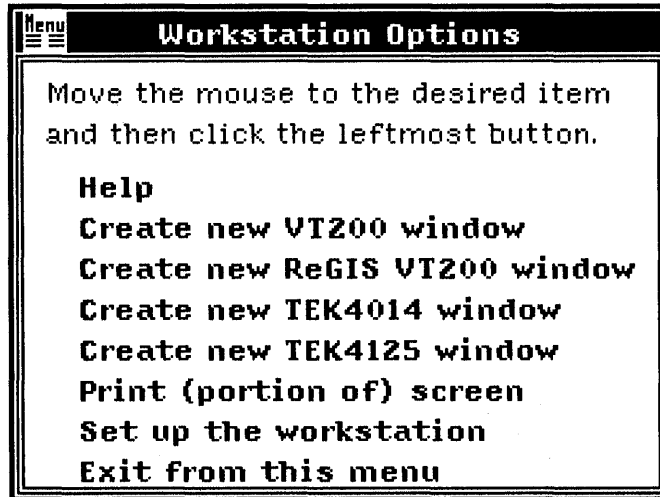

Although the menus serve different purposes, several have the **Exit from this menu** option. **Exit from this menu** erases (or *deletes*) the menu from the screen.

1.4 The Pointer and Pointing Devices

The arrow-shaped cursor on the VAXstation screen is referred to as the *pointer*. You use the pointer to select options from menus and perform various window-management tasks. To move the pointer on the screen, you use a *pointing device*. The *mouse* is an example of a pointing device. Your pointing device might be any of the following types:

- Mouse—the round three-button device that is packaged with your workstation.
- Puck—the square four-button device that is included with the optional tablet subsystem.
- Stylus—the pen-shaped device that is included with the optional tablet subsystem.

1.4.1 Using Pointing Devices

Each type of pointing device has one button designated as the *SELECT button*. You press the SELECT button to invoke menus and to manage windows on the screen. Depending on the task, you use the SELECT button in either of the following ways:

- Click—Press and release (click) the SELECT button.
- Hold Down—Press and hold down the SELECT button, move the pointing device, and then release the button.

The following sections provide more information on the pointing devices and the SELECT button.

1.4.2 Using the Mouse

You control the pointer by moving the mouse over a flat surface. You will find it easiest to position the pointer when you move the mouse with a steady motion.

The mouse determines its pointer position by *relative* means. That is, when you use the mouse, the pointer movement on the screen is determined by how far and in what direction you move the mouse from one point to another. The travel of the ball underneath the mouse is the critical factor, not the location of the mouse itself on a coordinate plane.

If you run out of surface space, pick up the mouse, put it further back on the surface, and then continue moving the mouse in the same direction. With a little practice, you can control the pointer movement.

By default, the left button on the mouse is the SELECT button. The remaining buttons are reserved for applications. You can reverse the order using the Pointer setup menu, and make the right button the SELECT button (see Section 2.5.4).

Figure 1-4 shows the default SELECT button on the mouse.

Figure 1-3 Mouse SELECT Button

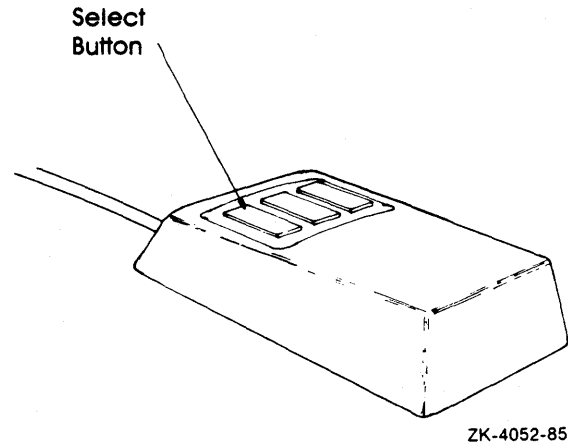

1.4.2.1

Using the Keyboard Instead of the Mouse

If the mouse stops working, you can perform most of the mouse functions by using the key combinations on the keyboard. Table 1-1 lists the key combinations and their corresponding functions:

Table 1-1 Key Combinations and Their Functions

Keys	Function
CTRL/SHIFT/↑	Moves the pointer up
CTRL/SHIFT/↓	Moves the pointer down
CTRL/SHIFT/←	Moves the pointer to the left
CTRL/SHIFT/→	Moves the pointer to the right
CTRL/SHIFT/E4	Performs the same functions as the SELECT button
CTRL/SHIFT/E5	Performs the same functions as the center button
CTRL/SHIFT/E6	Performs the same functions as the right button

1.4.3 Using the Tablet Subsystem

If your VAXstation is equipped with the tablet subsystem, you can use either the four-button puck (the mouselike device) or the two-button stylus (the penlike device) to move the pointer on the screen and to create windows. Unlike the mouse, which can be used on any flat surface, the puck or stylus can be used only with the tablet.

Figure 1-4 illustrates the tablet subsystem.

Getting Started

Figure 1-4 The Tablet Subsystem

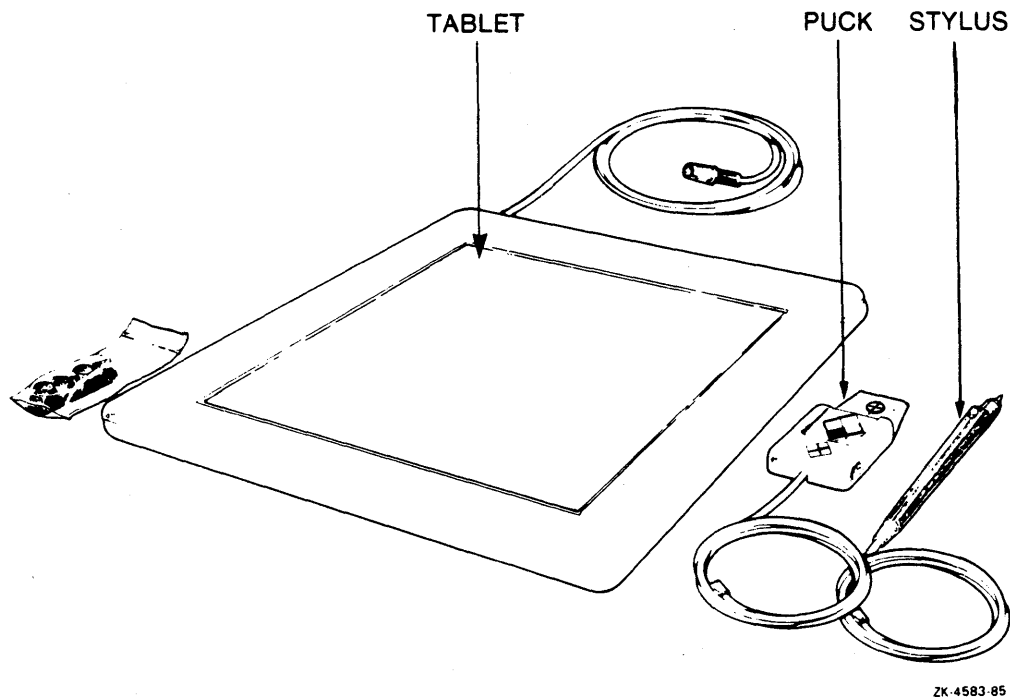

The tablet subsystem uses *absolute* means to determine the pointer position. The tablet is a magnetic sensing device that plots coordinates and correlates them to a point on the screen. The surface area within the grooves on the tablet represents the workstation screen. When you place the puck or the stylus over the surface within the grooves, the sensing device relays the coordinates of its location to the VAXstation. The VAXstation then positions the pointer on the corresponding location on the screen.

You use the puck or stylus the same way as the mouse. However, the puck and the stylus let you control the pointer more accurately. The puck includes a cross-hair indicator that you can use, for example, to trace an existing pattern or design. (Because the tablet system is a magnetic sensing device, you can place a piece of paper over the tablet surface.) The cross hair is the portion of the puck that pinpoints the coordinate position on the tablet.

The stylus gives you even greater control because of its size and shape. For example, you can use it to draw on the VAXstation screen.

You can switch between the stylus and the puck any time during a session. Each time you switch, though, you must unplug the tablet and then plug it in again so the tablet can determine the correct number of buttons on the pointing device. Otherwise, the buttons might not perform their normal functions.

1.4.3.1 Using the Puck

The puck has four buttons. By default, Button 1 is the SELECT button. The remaining three buttons are reserved for use in applications. You can reverse the order using the Pointer setup menu, so that Button 3 is the SELECT button (see Section 2.4.4). Button 1 then becomes 3. Buttons 2 and 4 do not change. Figure 1-5 shows the puck:

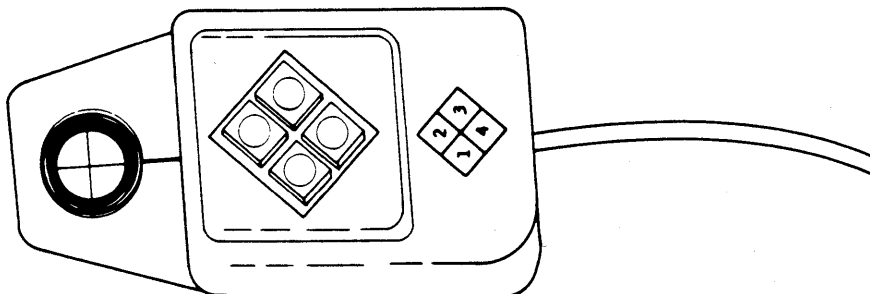
Figure 1-5 The Puck

MLO-1065-87

1.4.3.2 Using the Stylus

The stylus has two buttons: one on the outside of the barrel and one at the tip of the barrel. You hold the stylus as you would hold a pen. You activate the button on the tip by pressing down on the tip.

By default, the button on the outside of the barrel is the SELECT button. The button on the tip is reserved for applications. You can reverse the order of the buttons with the Pointer setup menu (see Section 2.4.4). The stylus is shown in Figure 1-6.

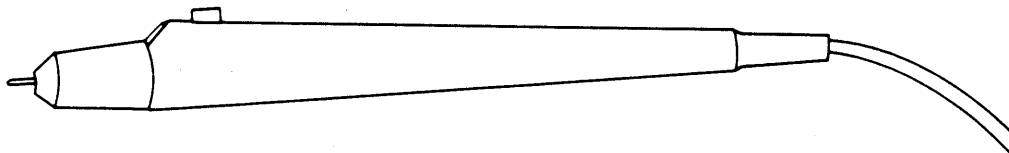
Figure 1-6 The Stylus

MLO-1066-87

1.5 Function Keys

The function keys **[F1]**, **[F2]**, **[F3]**, **[F4]**, and **[F5]**, on the upper left of the keyboard, have the following functions:

- **[F1]**—Hold Screen

Getting Started

Pressing **F1** keeps the entire screen display from changing and stops process activity until you press **F1** again. However, **F1** can not suspend activity in the Workstation Options menu or in the HELP, PRINT, or SETUP functions that can be initiated from the Workstation Options menu.

- **F2**—Operator Window

Pressing **F2** displays at the top of the screen any messages sent to the operator window (OPA0). For example, if you try to print on a remote device that is not accessible, the software sends a message to OPA0.

To erase the operator display, press **F2** again.

NOTE: Section 1.6 gives detailed information about using the operator window.

- **F3**—Switch Windowing System

Pressing **F3** switches between windowing systems. You use it with custom applications that use the QIO device driver instead of the workstation software windowing system on workstations with a VCB01 graphics module (VAXstation I and II). For details, see the *VMS Workstation Video Device Driver Manual*.

- **F4**—Reserved for future use

- **F5**—Change Active Window

Press **F5** to *cycle* through windows to which the keyboard can be attached, or *connected*. (Only windows that can be connected to the keyboard can become active.) Each time you press **F5**, another window pops to the foreground of the display to become the active window.

A terminal-emulator window that is not connected to the keyboard is inactive. An inactive terminal-emulator window "remembers" its cursor position. When a terminal-emulator window is disconnected from the keyboard, a nonblinking cursor outline marks the cursor position.

You can also use **F5** to reset color-map entries for the screen background on GPX systems. Sometimes when an application used the hardware color map, some windows might become "invisible" or display incorrect colors. You can use **F5** to restore the color-map entries for the screen background, the window foreground and background, and the pointer.

To restore the color-map entries on your GPX system, press **F5**. Then move the pointer to the banner or border of a window and click the mouse SELECT (M1) button.

1.6 The Operator Window

The operator window, OPA0, serves as a viewport to both the console and the operator terminal device. When the VMS system is halted, you can use the operator window to enter commands at the console prompt (>>>). When VMS is running (but the workstation software is not), you can use the operator window to log on to OPA0. The operator window is dependent only on the VMS base system and is different from the workstation software terminal emulator windows. It is not a full-function terminal.

The operator window appears in the top portion of the VAXstation screen, regardless of whether the workstation software is running. If you were to install VMS without the workstation software, the entire screen would be dark and OPA0 would be your only means of logging on to the system.

1.6.1 Using the Operator Window

The operator window appears on the screen when you press **[F2]** and/or when a message is sent to OPA0.

Pressing **[F2]** displays at the top of the screen any messages sent to the operator device (OPA0). For example, if you try to print on a remote device that is not accessible, the software sends a message to OPA0. To erase the operator display, press the **[F2]** key again.

When a message is sent to OPA0 (for example, a device-offline error message), the operator window automatically appears. However, the keyboard does not automatically connect to the operator window. The keyboard connects to it only if the display manager process has not yet been started. Keyboard input continues to be directed to OPA0 until you log out of that process. To erase the operator window display press **[F2]**.

NOTE: You can connect to the operator window even when it is not visible. If you need to halt the system and enter commands at the console prompt >>>, press the **[F2]** key *before* you press the Halt button. If you press the Halt button first, the **[F2]** key is useless and the operator window might not appear. Since there is no screen activity, the system appears to be dead. However, any commands you enter still go to the console. To return the system to its normal screen activity, type C (for Continue) and press **[RETURN]**.

1.6.2 Operator Window Functions on Color and Intensity Systems

The operator window functions differently on color and intensity systems than on monochrome (bitonal) systems. The following characteristics apply to color and intensity systems:

- Writing or drawing operations do not continue while the operator window is displayed.
- The entire screen is used as the operator window when the system boots or crashes. The windowing system starts after the startup procedure ends.

Getting Started

Because the operator window covers the entire screen, the system might appear to be hung at startup or shutdown time. If a message is written to the operator window, the window remains on the screen until you press **F2**. Therefore, you might need to press **F2** to change the screen display after the installation is completed. (The installation is complete when the "job terminated" message appears.)

- The screen color changes when the operator window appears. Press **F2** to remove the operator window and return the screen to its original colors.
- The data in the operator window is lost when the operator window is removed from the screen.

The Workstation Options Menu

The Workstation Options menu is the *main menu* on the workstation. You use the Workstation Options menu to get started with the VMS Workstation software. The menu lists options such as "Help" and "Create new VT220 window." Figure 2-1 shows the Workstation Options menu:

Figure 2-1 Workstation Options Menu

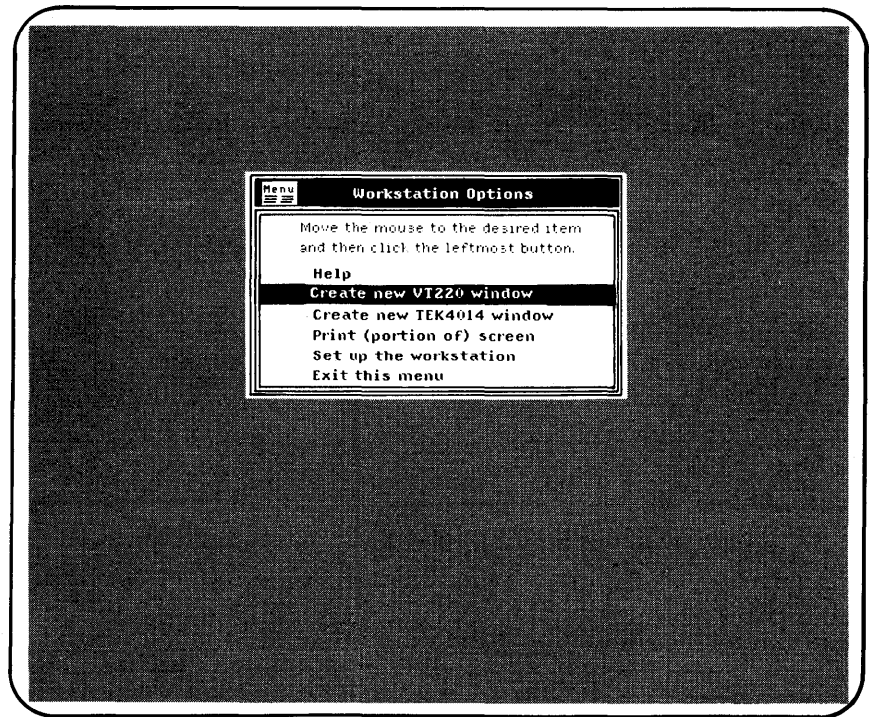

ZK-4053-85

This chapter describes the options that you can select from the Workstation Options menu.

You can also modify the Workstation Options menu to suit your own needs. Section 2.6 describes the menu attributes and provides instructions for modification.

To invoke the Workstation Options menu, place the pointer in a blank area of the screen (that is, not within the boundaries of an existing window) and click the SELECT button on the mouse.

The Workstation Options Menu

NOTE: If the Workstation Options menu does not appear, the display manager process (VWSS\$DISPLAYMGR) is not running. The display manager process is necessary for creating and managing all windows, including menus. In order to restart VWSS\$DISPLAYMGR, you must reboot the system. For instructions on rebooting your system, see the installation guide for your base system.

If the display manager is not running, check the appropriate error log to determine why. Rename or copy the error log to another directory so it cannot be deleted. Submit a QAR with the error log to Digital, then reboot.

To select an option, move the pointer until the contrasting bar is over the desired option. Then click the SELECT button to invoke the Help window. For example, Figure 2-2 shows the Workstation Options menu with the "Help" option selected.

Figure 2-2 Workstation Options Menu with HELP Selected

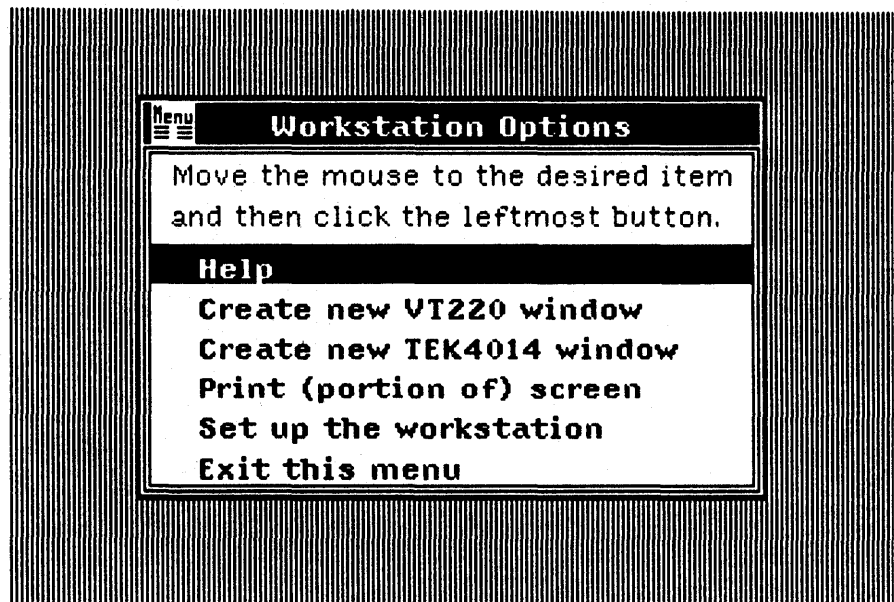

ZK 5478-86

2.1 Obtaining Help

When you select "Help" from the Workstation Options menu, a window containing a list of help topics appears. The keyboard is automatically connected to the window.

To read about a help topic, type its name and press RETURN. You can abbreviate to the first few characters that uniquely identify the help topic.

To redisplay the list of help topics while Help is running, type a question mark (?) and press RETURN.

To exit from HELP and delete the HELP window, either type EXIT and press RETURN or press CTRL/Z.

When you select any of the options listed in the Workstation Options menu, the menu automatically disappears from the workstation screen. If you decide not to select an option from the menu and you simply want to remove the menu from the screen, use the option "Exit this menu."

2.2 VT220 Terminal Emulation

To use VT220 emulation, select "Create new VT220 window" from the Workstation Options menu. Figure 2-3 shows a new VT220 terminal-emulator window.

Figure 2-3 VT220 Terminal-Emulator Window

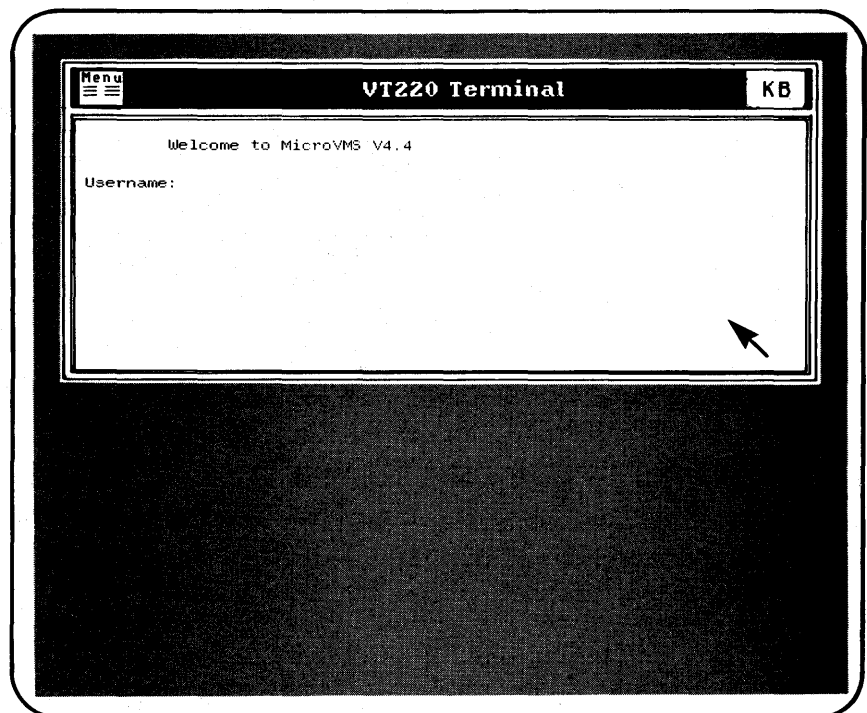

ZK-4054-85

In VT220 terminal emulation, your keyboard interacts with the system as it does with a VT220 terminal. This section describes only the differences between the physical VT220 terminal and the terminal emulator. Following are the major differences:

- Function keys **F2** through **F5** on the workstation terminal do not perform the same functions as on the VT220 hardware series terminal. However, you can use some of the function keys at the top of the LK201 keyboard for certain line-editing functions if line editing is enabled for Digital Command Language (DCL). See Table 2-1 for details on the line-editing functions.

The Workstation Options Menu

Table 2-1 VT220 Line-Editing Functions

Key	Function
F6	Cancel
F10	Exit
F12	Beginning of Line
F13	Delete (previous) Word
F14	Insert/Overstrike

The function keys F7, F8, F9, and F11 are reserved for future use.

- The terminal emulator does not support dynamically redefinable character sets (DRCS). However, the terminal emulator does have the Digital standard technical character set (TCS) and uses a parameter to report its presence.
- The BREAK and DATA/TALK functions are not relevant to the terminal emulator and therefore are not included.
- The SETUP and PRINT functions are implemented by VMS Workstation software menu routines.
- In certain modes of operation, some keys (or combinations of keys) are not supposed to click; these keys might click with the terminal emulator.
- The terminal emulator does not support escape sequences for Keyboard Access mode or Screen mode
- When the SHIFT key is pressed in SHIFT-LOCK mode using the terminal emulator, the shift state is not unlocked.

Once you have created a VT220 emulation window, you have 30 seconds to log on before the window disappears. See Section 3.1 for information on logging on to the system.

See Appendix B for information about using VT220 terminal-emulator logical names and escape sequences. For more information on the VT220, consult the *VT220 Owner's Manual*.

2.3 Tektronix 4010/4014 Terminal Emulation

To use Tektronix 4010/4014 terminal emulation, select "Create new TEK4014 window" from the Workstation Options menu. (See Section 3.1 for information on logging on to the system.)

Tektronix 4010/4014 terminal emulation simulates the Tektronix 4010/4014 terminal with the enhanced graphics module. Table 2-2 lists the features supported by the VAXstation.

Table 2-2 VAXstation Supported Features

Emulated	Not Emulated
Alpha mode text sizes	Alternate character set
Bypass mode	Incremental plotting
Defocused mode	Special point plotting
Graphics input	Write-through
Margin processing	Enhanced graphics resolution
Point plotting	

All alphanumeric keys and function keys on the Tektronix 4010/4014 keyboard have corresponding keys on the VAXstation LK201 keyboard. However, other Tektronix 4010/4014 user controls do not have corresponding keys on the LK201 keyboard.

To erase the contents of the Tektronix 4010/4014 window display, press any of the following:

- The E6/NEXT SCREEN keypad key on the LK201 keyboard
- The center button on the mouse
- The Number 2 button on the puck

In graphics input (GIN) mode, the pointer controls the cross hair. To terminate GIN mode, press the RETURN key or the mouse SELECT button.

Appendix A contains additional information about Tektronix 4010/4014 terminal emulation. For further information, consult Tektronix 4010/4014 documentation.

2.4 Printing a Portion of the Screen Display

If a printer is accessible to your workstation, you can print any rectangular portion of the screen display by using the following procedure.

- 1 Make sure that your printer is turned on and that the paper is properly loaded.
- 2 Use the pointer to select "Print (portion of) screen" from the Workstation Options menu. The pointer changes shape to resemble an arrowhead, pointing toward the upper left-hand corner of the screen.
- 3 Move the pointer to the upper left-hand corner of the rectangular area you want to print.
- 4 Press and hold down the SELECT button. The arrowhead now points toward the lower right-hand corner of the screen.

As you move the pointer, a "stretchy box" follows.

- 5 Move the pointer until the stretchy box surrounds the area that you want to print.

The Workstation Options Menu

- 6 When the box surrounds the area that you want printed, release the SELECT button.

The printer begins printing and the pointer changes shape again so it resembles an hourglass. When the printing finishes, the pointer returns to its original (arrow) shape.

To cancel the operation (before actually printing), position the pointer at the starting point and release the SELECT button.

In Figure 2-4, the user has drawn a cartoon figure within an application and selected the portion of the screen that contains the figure for printing.

Figure 2-4 Selected Screen Print Area

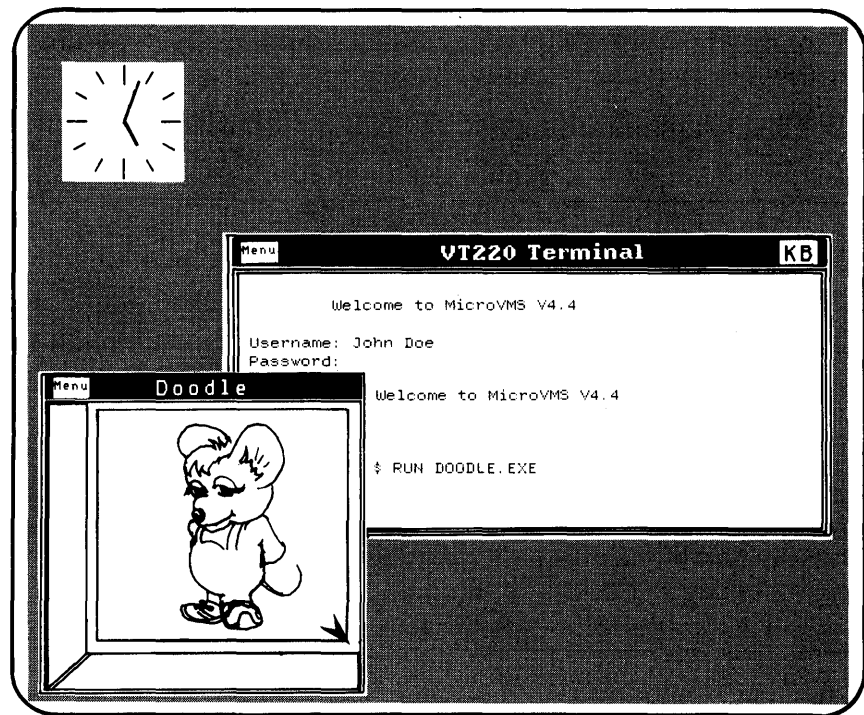

ZK-4056-85

2.4.1 Changing Print Destination

Instead of printing part of the screen display, you can send parts of the screen to a file or to a print queue. The destination can be a remote file or device, making it possible to use a shared hardcopy device on another node in the network. However, the device must accept *sixel-format* output. *Sixel* is the format by which the output characters are interpreted. Sixel format lets special graphics characters be displayed.

In addition to printing selected portions of the screen, you can perform conventional file printing operations (using print queues) from a terminal-emulator window.

You can no longer select the "Enter new print destination" option from the Printer Setup menu to redefine the screen output destination. See "Enter new print destination" in Section 2.5.6 for instructions on how to redefine screen output destination.

In all cases, the final output device (such as any workstation printer described in the owner's manual for your VAXstation) must be able to accept sixel-format output.

See Section 2.5.6 for a description of the printer setup features.

For more information on printing graphics from the VAXstation, see the *VMS Workstation Guide to Printing Graphics*.

2.5 Workstation Setup Menu

Certain keyboard and terminal features on the VAXstation have default settings, or *attributes*. You can use the Workstation Setup menu to change one or more of these attributes.

To change setup attributes, select "Set up the workstation" from the Workstation Options menu. The Workstation Setup menu, shown in Figure 2-5, appears.

Figure 2-5 Workstation Setup Menu

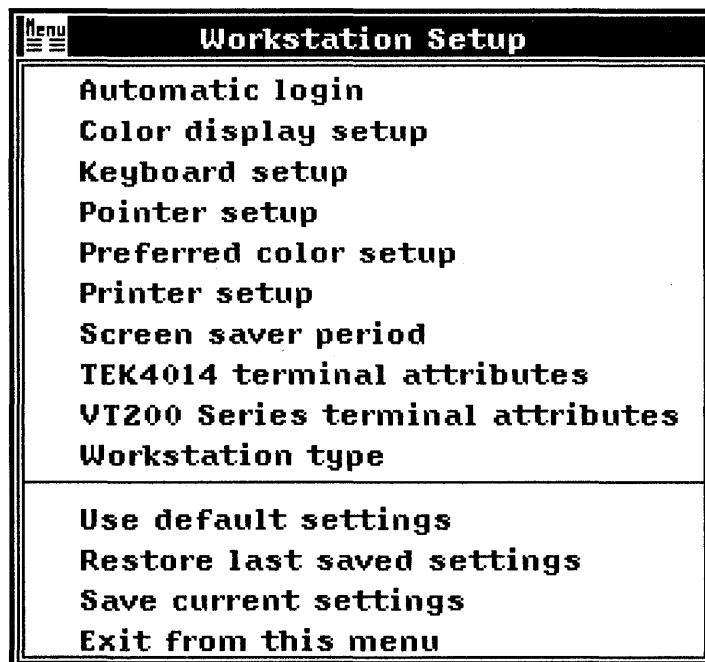

The Workstation Options Menu

When you select an option from this menu, a *submenu* appears. There are two kinds of submenus. One shows a range of values with an arrow indicating the current value; the other shows options with a check mark next to the currently selected option.

If you just want to look at a current setting, press the SELECT button after noting the setting.

To change an attribute, move the pointer to the submenu and select a new setting by pressing the SELECT button.

When you change setup attributes, the new attributes take effect at different times, depending on the option. For example, if you change the setup attribute for the Keyboard setup option "Keyclick volume," the new attribute takes effect when a new window is created. On the other hand, some attributes take effect immediately.

The setup options are described in the following sections.

2.5.1 Automatic Login

The Automatic Login option enables or disables automatic login. If automatic login is enabled (the default), you need only log on to the system once; after that, you can create new VT220 or Tektronix 4010/4014 windows under the same account without reentering your user name and password.

If you want to log on to the system under a different account, you must disable automatic login before you invoke a new terminal-emulator window. (Alternatively, you can modify the functions of the Workstation Options menu; see Section 2.7 for details about modification.)

Because Automatic Login bypasses some standard VAX/VMS login mechanisms, you might see some unusual side effects. The following sections provide further information.

2.5.1.1 Side Effects of Automatic Login

Two potentially undesirable effects can result from enabling Automatic Login: delayed window creation and incorrect setting of terminal attributes. The following subsections explain to minimize these side effects.

Excessive Waiting for Windows

To minimize the time you spend waiting for windows to be created, edit the system command file SYS\$MANAGER:SYLOGIN.COM to include a line at the beginning of the file that writes a short message to SYS\$OUTPUT. For example:

```
$ WRITE SYS$OUTPUT "Good morning"
```

A terminal-emulator window is not actually created until output is written to it. Therefore, writing a short message at the beginning of the system login procedure makes window creation seem faster.

Incorrect Fonts Used in Windows

To avoid unpredictable terminal attributes caused by including the DCL command SET TERMINAL in your login command file, modify the file to include a line at the beginning that writes a short message to SYS\$OUTPUT *before* invoking the SET TERMINAL command.

2.5.2 Color Display Setup

This option refers to the workstation *standard* colors, which are a set of colors used for the background and foreground colors of the window display.

NOTE: Not all options are enabled for the different types of systems. Read the following section that refers to your specific system type: monochrome (bitonal), intensity, or color.

Selecting the Color Display Setup option invokes a menu that offers the following options:

Option	Description
Pointer foreground	The filled portion of the pointer
Pointer background	The outline portion of the pointer
Display background	The entire field (colored or monochrome) behind any of the windows on the workstation screen
Window foreground	The output sent to a window (text or graphics)
Window background	The field (colored or monochrome) in the window behind the window output
Update color map	Initiates the new settings

Move the pointer to the option you want and click the SELECT button. Then select "Update color map" to ensure that the new setting takes effect. If you neglect to update the color map, any changes are lost.

The "Window foreground" and "Window background" options pertain to terminal-emulator windows and any other windows that can be connected to the keyboard.

NOTE: Make sure the window background and foreground colors are different, otherwise the text within the window will be invisible.

The enabled color-display options vary according to workstation type.

2.5.2.1 Standard Color Setup on Monochrome (Bitonal) Systems

For monochrome (bitonal) systems, only the following options are enabled:

- Display background
- Window foreground
- Window background

The Workstation Options Menu

An additional option is "Update color map". To save any changes you make, you *must* select "Update color map."

Selecting any of these options (except "Update color map") causes two boxes to appear, one underneath the other. The top box is labeled according to the selection (for example, "Display background") and displays the currently selected color. The bottom box is labeled "Intensity" and displays a bar that shows following settings:

- For Display background—The intensity settings include:
 - Black (at far left)
 - Grey 25%
 - Grey 50% (in the center)
 - Grey 75%
 - White (at far right)

(Figure 2-6 shows the monochrome (bitonal) Display-background setup menu.)

- For Window foreground—The intensity settings include Black (at far left) and White (at far right).
- For Window background—The intensity settings include Black (at far left) and White (at far right)

Move the pointer and click the SELECT button to choose the desired setting. If you change the Window Foreground or the Window Background color, the new color setting takes effect when the next window is created.

Figure 2-6 Display-Background Setup for Monochrome (Bitonal) System

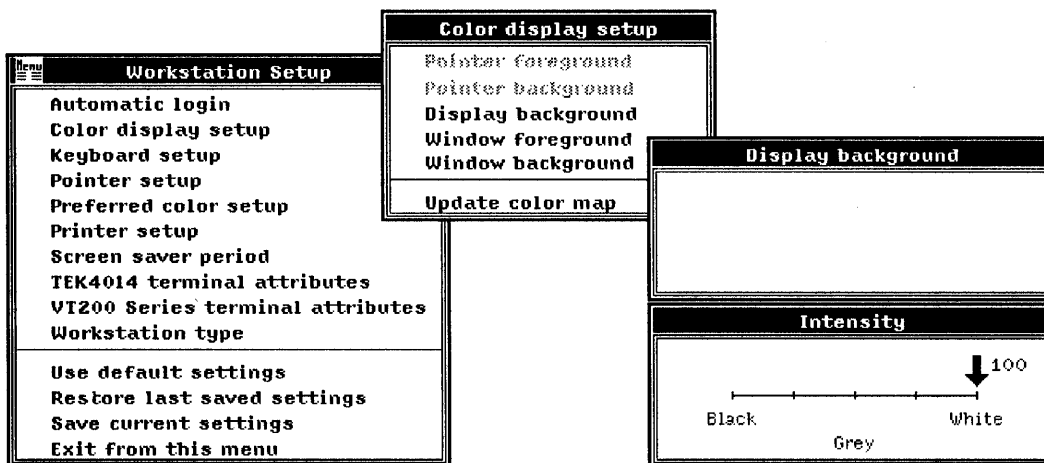

If you change the Display Background color and select "Update color map," the new setting takes effect after all windows are deleted or after the system is rebooted.

2.5.2.2 Standard Color Setup on Intensity Systems

For the intensity systems, all color-display options are enabled; however, the color tones are simulated in shades of grey. The shades vary according to the intensity selected.

Selecting any option (except "Update color map") causes two boxes to appear, one underneath the other. The top box is labeled according to the selection (for example, "Pointer foreground") and displays the currently selected shade. The bottom box is labeled "Intensity" and displays a bar with a full range of settings from 0% (at the far left) to 100% (at the far right). Figure 2-7 shows the intensity Window-background setup menu:

Figure 2-7 Window-Background Setup for Intensity System

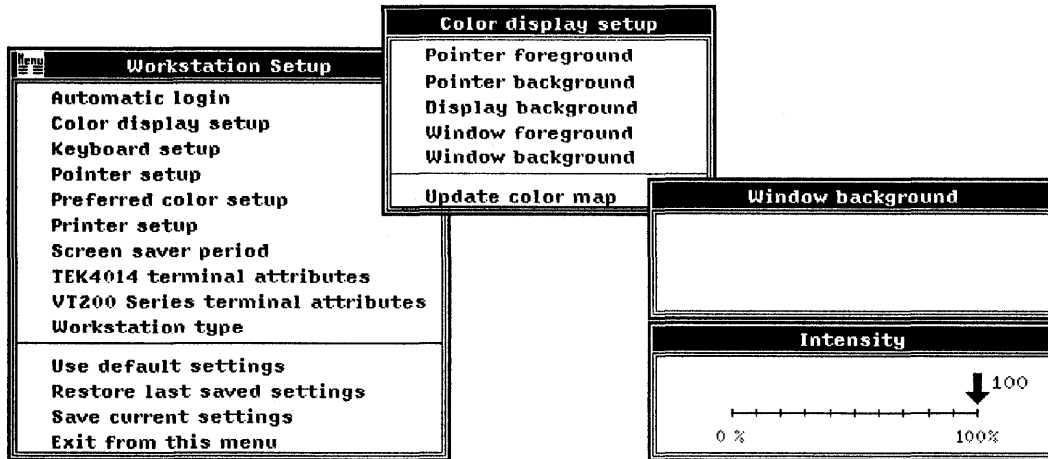

To select a setting, move the pointer and click the SELECT button. To find a precise setting, you might find it easier to simply *click and hold down* the SELECT button while you move the pointer along the intensity bar. The arrow-shaped indicator over the bar moves with the pointer, and the intensity level (displayed as *n%* next to the indicator) changes simultaneously. In addition, the color shade in the top box, which is filled in with the currently selected shade, changes as you move the pointer. When you find the desired setting, release the SELECT button.

If you change any of the intensity settings, the new setting takes effect as soon as you select "Update color map."

2.5.2.3 Standard Color Setup on Color Systems

For color systems, all color-display options are enabled and any option can be set to the desired hue.

Selecting any option (except "Update color map") causes four boxes to appear, stacked in a column. The top box is labeled according to the selected option (for example, "Pointer foreground") and displays the currently selected color setting for that option. The remaining three boxes are labeled "Red," "Green," and "Blue"—each of which displays a range

The Workstation Options Menu

of intensity from 0% to 100%. By increasing or decreasing the values of these ranges, you can select the desired hue for each color option. Figure 2-8 shows the color Pointer-foreground setup menu:

Figure 2-8 Pointer-Foreground Setup for Color System

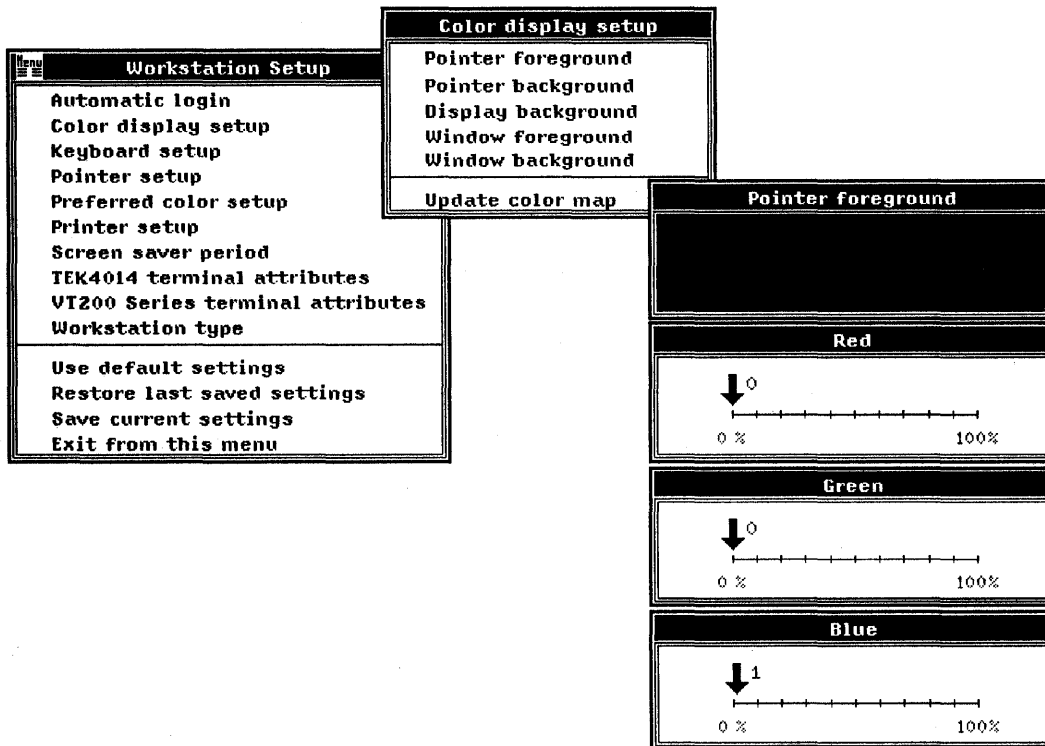

As you move the pointer, the color in the top box (which is filled in with the currently selected hue) changes as you move the pointer.

If you change any of the color settings, the new setting takes effect as soon as you select "Update color map."

2.5.3 Keyboard Setup

This option invokes the Keyboard setup menu, which includes the following options:

Autorepeat

Selecting Autorepeat displays a menu from which you can either enable or disable autorepeat. If enabled, a key that is held down repeats. (For example, jjjj.) If disabled, the key does not repeat.

If you change the keyboard autorepeat attribute, the new attribute takes effect when a new window is created. The current selection is indicated with a check mark.

Bell volume

Selecting Bell volume displays a range of volumes from softest (off) to loudest. The "bell" is the beep sound made by the keyboard (for example, when some errors occur or messages arrive).

If you change the bell volume setup attribute, the new attribute takes effect immediately. The current selection is indicated by an arrow.

Keyboard function

Selecting Keyboard function invokes a menu that offers the following keyboard-character options:

- Typewriter keys (the default)
- Data processing keys

For North American keyboards, select "Typewriter keys."

For all other keyboards, select either "Typewriter keys" or "Data processing keys." "Typewriter keys" selects the characters on the left half of the keycaps. "Data processing keys" selects the characters on the right half of the keycaps.

For example, the French Canadian keyboard includes a key that has a C cedilla "Ç" on the left side and brackets ([]) on the right. Selecting "Typewriter keys" on the French Canadian keyboard causes this key to respond as uppercase and lowercase C cedilla Ç. Selecting "Data processing keys" causes this key to respond as "[" and "]".

The current selection is indicated with a check mark.

Keyclick volume

Selecting Keyclick volume displays a range of volumes from softest (off) to loudest. A keyclick is the sound made when a keyboard key is pressed.

If you change the keyclick volume attribute, the new setting takes effect when a new window is created. The current selection is indicated by an arrow.

Lock state

Selecting Lock state invokes a menu that offers the following LOCK key options:

- Caps lock (default)
- Shift lock

If you select "Caps lock," LOCK causes all alphabetic characters on the keyboard to be uppercase; all other keys are unaltered.

If you select "Shift lock," LOCK causes all keys to be uppercase. The current selection is indicated with a check mark.

Language

Selecting Language displays a list of the languages that can be associated with the keyboard. From this list, you can select the keyboard configuration you want to use.

If you change the keyboard language, your keyboard uses the character set associated with that language. For example, if you select FRENCH, your keyboard emulates a French keyboard. (Appendix D of this user's guide illustrates the various keyboards.)

A check mark identifies the current selection. The following options are available:

- BRITISH
- CANADIAN_FRENCH
- DANISH LK201_AD and LK201_ED
- DUTCH
- FINNISH
- FLEMISH_BELGIAN
- FRENCH
- GERMAN
- ITALIAN
- NORTH_AMERICAN
- NORWEGIAN LK201_AN and LK201_EN
- PORTUGUESE
- SPANISH
- SWEDISH
- SWISS_FRENCH
- SWISS_GERMAN

If you select a new language, the new setting takes effect the next time you create a window.

The Workstation Options Menu

2.4.4 **Pointer Setup**

This option invokes the Pointer setup menu, which displays the following pointing-device options:

Button order

Selecting this option invokes the Button order menu, which displays the following mouse- and puck-button options:

- Right-handed (the default)
- Left-handed

By default, mouse and puck buttons are set to "Right-handed". On the mouse, the left button is the SELECT button, and the middle and right buttons are reserved for applications. On the puck, the button numbered 1 is the SELECT button, and the remaining three buttons are reserved for applications.

To reverse the order of the buttons, select "Left-handed" from the Button order menu. On the mouse, the right button becomes the SELECT button, and the middle and left buttons are reserved for applications. On the puck, the button numbered 3 becomes the SELECT button, and the button that was formerly numbered 1 becomes Number 3. The buttons numbered 2 and 4 remain unchanged.

Stylus SELECT button

Selecting this option invokes the Stylus SELECT button menu, which displays the following stylus-button options:

- Barrel button (the default)
- Tip of stylus

By default, the button on the outside of the barrel is the SELECT button, corresponding to the left button on the mouse, and the tip button is reserved for applications.

If you select the "Tip of stylus" option, the tip button becomes the SELECT button.

2.4.5 **Preferred Color Setup**

The term *preferred colors* refers to the set of colors representing users' preference for the eight combinations of the RGB (red, green, and blue) primary colors. These colors are specified for use in applications and their settings have no bearing on the *standard* workstation colors described in Section 2.4.2.

If you are working with a color application, for example, you might want to define a specific shade of red instead of a full-intensity red. On an intensity system, you can use the preferred color setup to define a white base level from which shades of grey are derived.

On a monochrome (bitonal) system, preferred colors are translated to either black or white, whichever is closer to the specified color intensity.

For more information on standard colors and preferred colors, see the *VMS Workstation Graphics Programming Guide*.

Selecting the "Preferred color setup" option invokes a menu that allows you to change these settings. The preferred color options are:

- Black
- White
- Red
- Green
- Blue
- Cyan
- Yellow
- Magenta

An additional menu item is "Update color map," which you must always select after changing any color settings in order for the new settings to take effect. If you do not select "Update color map," any changes will be lost.

To make a selection, move the pointer to the option you want and click the SELECT button.

If you change any of the color settings, the new setting takes effect as soon as you select "Update color map." The color functions vary according to workstation type (as described in the following sections).

2.4.5.1 Preferred Color Setup on Monochrome (Bitonal) Systems

If you define preferred colors on a monochrome (bitonal) system, those colors can only be interpreted as black or white.

Selecting any preferred color option (except "Update color map") causes two boxes to appear, one beneath the other. The top box is labeled according to the selection (for example, "Red") and displays the currently selected color setting. The bottom box is labeled "Intensity" and displays a bar that shows the possible settings, which are Black (at the far left) and White (at the far right). Move the pointer and click the SELECT button to select the desired setting. An arrow indicates the current setting.

See Figure 2-5 for an illustration of the monochrome (bitonal) setup menu.

2.4.5.2 Preferred Color Setup on Intensity Systems

For the intensity system type, the preferred color tones are simulated in shades of grey. The shades vary according to the intensity selected.

Selecting any option (except "Update color map") causes two boxes to appear, one beneath the other. The top box is labeled according to the selection (for example, "Red") and displays the currently selected shade. The bottom box is labeled "Intensity" and displays a bar with a full range of settings from 0% (at the far left) to 100% (at the far right). See Figure 2-6 for an example of the Intensity box.

Move the pointer and click the SELECT button to select a setting. To find a precise setting, you can find it easier to simply *click and hold down* the SELECT button while you move the pointer along the intensity bar. The arrow-shaped indicator over the bar moves with your pointer,

The Workstation Options Menu

and the intensity level (displayed as *n%* next to the indicator) changes simultaneously. In addition, the color shade in the top box, which is filled in with the currently selected shade, changes as you move the pointer. When you find the desired setting, release the **SELECT** button.

2.4.5.3 Preferred Color Setup on Color Systems

For the color system type, any preferred color option can be set to the desired hue.

Selecting any option (except "Update color map") causes four boxes to appear, stacked in a column. The top box is labeled according to the selected option (for example, "Red") and displays the currently selected color setting for that option. The remaining three boxes are labeled "Red," "Green," and "Blue". Each displays a range of intensity from 0% to 100%.

See Figure 2-7 for an example of the color boxes. By increasing or decreasing the values of these ranges, you can select the desired hue for each color option. As you move the pointer, the color in the top box (which is filled in with the currently selected hue) changes as you move the pointer.

NOTE: If you set your window background and foreground colors to be very similar, or the same, you are prompted for confirmation before you can use the new colors. This feature prevents you from making the colors so close that window contents are unreadable or invisible.

2.4.6 Printer Setup

Selecting this option invokes the Printer setup menu, which displays the following printer options:

Aspect ratio

- 2 to 1 (the default)
- 1 to 1

When you select a portion of the screen for printing, the size of the printed output might not be the same as that of the selected screen image, depending on the type of device you use for printing.

The relationship between the original image size and the printed size is referred to as *aspect ratio*. If the aspect ratio is 2 to 1 (2::1), the printed output is twice the size of the original image. If the aspect ratio is 1 to 1 (1::1), the printed output is the same size as the original image.

The default for the aspect ratio is 2::1. You can change the default by selecting "1 to 1" from the Aspect ratio menu. A 1-to-1 aspect ratio is useful for sending the selected output to a VT220 terminal-emulator window, because the normal-size image is sharper than the enlarged image.

NOTE: Some devices support only 1::1 printing; the default of 2::1 has no effect on such devices. You can determine the aspect ratio for your printer

by comparing the output with the original or by consulting the owner's manual for your printer.

Color conversion method

- Black and white (the default)
- Grey shades
- Eight colors

If you have an intensity or color system, this option lets you control the contrast between colors if they must be converted to black and white. The default, which is "Black and white," provides the sharper image. However, if you want the converted image to distinguish among a larger number of color tones, select "grey shades."

You can also choose 8-color printing if you have specified a (sixel) color printer as the print destination.

Enter new print destination

The "Enter new print destination" option of the Printer Setup menu is now disabled. To change the print destination, assign the logical `UIS$PRINT_DESTINATION` to the desired value.

For example:

```
$ DEFINE/SYSTEM/EXEC UIS$PRINT_DESTINATION "CSAO:"
```

Print queue management

- Execute requests immediately (the default)
- Accumulate requests

Selecting this option displays the method the print queue uses to handle print requests. By default, print requests are executed immediately. If you change the default, print requests accumulate until you submit them for printing (see the *VMS User's Manual* for more information).

To use either of these queue-handling methods, you must have a print queue set up as described in the *VMS User's Manual*.

If you change the print queue management, the change takes effect upon the next print request. Note, however, that "Print queue management" selections only take effect if the print destination is a queue.

You can add a carriage return and a form feed automatically appended to your files by typing at the \$ prompt:

```
DEFINE/SYS/EXEC UIS$PRINT_CRFF "YES"
```

NOTE: This logical name is in effect until you reboot the system. When you reboot, the logical name no longer exists. If you want this change permanently made, define the logical name in the system file `SYS$SYSTARTUP.COM`. Changing the system file requires system privileges. After the file is changed, the logical name is available to any user who logs in.

See Appendix B for a complete list of the logical names available for use on your workstation.

The Workstation Options Menu

Ribbon or toner saver

- Positive image (the default)
- Negative image

If a large portion (such as the background color) of the image is black, you can reduce wear and tear on your printer by selecting "Negative image", which reverses the output color.

2.4.7 Screen Saver Period

The screen saver period is the amount of time that your screen is not in use before the screen display switches off. To prevent screen wear, the screen display switches off after 15 minutes of nonuse. Moving the mouse or pressing any key renews the display.

You can modify the time with the "Screen saver period" option. Selecting this option displays a range of time from 0 to 60 minutes.

If you set the screen saver period to 0, the screen display does not go off unless the power to the monitor or the system unit is switched off.

If you change the screen saver period, the new value takes effect immediately.

2.4.8 Tektronix 4010/4014 Terminal Attributes

Selecting this option displays a menu of Tektronix 4010/4014 terminal emulation attributes (strap options). A check mark before an attribute means it is enabled.

To enable or disable an attribute, move the pointer to the item you want to change. The selected attribute is highlighted in reverse video. Then click the SELECT button.

The options are:

- Ignore DELETE character in graphics mode.
- Send the RETURN character on GIN termination.
- Send the RETURN and EOT characters on GIN termination.

See your Tektronix 4010/4014 documentation for more information about these attributes.

If you change a Tektronix 4010/4014 terminal attribute, the new attribute takes effect when a new window is created or the DCL command SET TERMINAL is executed within a particular Tektronix 4010/4014 window.

2.4.9 VT220 Terminal Attributes

Selecting this option displays a menu of VT220 terminal-emulation attributes. If you change a VT220 terminal attribute, the new attribute takes effect when a new window is created or the DCL command SET TERMINAL is executed within a particular VT220 window.

NOTE: Resizing an existing window has the same effect as creating a new window.

The VT220 terminal-emulator attributes you can define using the Workstation Setup menu are:

Character set

Selecting this option invokes a menu with the following options:

- ASCII (the default)
- NRC

A check mark indicates the current selection.

If "NRC" (National Replacement Character set) is chosen, the ASCII codes are replaced by characters specific to the keyboard language chosen.

The default is "ASCII"; the standard North American characters are used.

Clear screen on resize

Selecting this option invokes a menu with the following options:

- Enable
- Disable (the default)

If "Enable" is checked, the VT220 emulator window clears (becomes blank) when resized. The default is "Disable"; the screen retains its original contents after it is resized.

Conforming sizes only

Selecting this option invokes a menu with the following options:

- Enable
- Disable (the default)

If "Enable" is checked, the VT220 window width can be set only to 80 or 132 columns. The default is "Disable"; the window width can be set to any desired number of columns (up to 160).

Cursor type

Selecting this option invokes a menu with the following options:

- Underline cursor
- Block cursor (the default)

The cursor marks the area on the VT220 window where the next typed character will appear, if appropriate. The cursor can be set either as a rectangle (block) or an underscore (VT52 default).

The Workstation Options Menu

Margin bell

Selecting this option invokes a menu with the following options:

- Enable
- Disable (the default)

The "bell" is the beep sound made by the keyboard. If the margin bell is enabled, the bell sounds when the cursor is positioned at 8 columns from the right margin. The default is "Disable"; the bell does not sound.

Numeric keypad mode

Selecting this option invokes a menu with the following options:

- Numeric keypad (the default)
- Application keypad

The numeric keypad is the set of numbered keys at the right of the keyboard. When set to "Application keypad," the keypad keys send escape sequences and can be defined for application-specific functions.

The default is "Numeric"; the keypad keys can be used to type numbers.

NOTE: An application can override your setup menu setting.

Page length

Selecting this option produces a box containing a bar, which you can set to the number of lines to be displayed in a newly created VT220 terminal emulator window.

The default is 24 lines.

Page width

Selecting this option produces a box containing a bar, which you can set to the number of columns to be displayed in a newly created VT220 terminal emulator window.

The default is 80 columns.

SIXEL scrolling

Selecting this option invokes a menu with the following options:

- Enable
- Disable (the default)

If you print or type a sixel-format graphics image or file within a VT220 terminal-emulator window, the graphics stops printing at the bottom of the page. That is, the graphics does not *scroll*.

To view the entire contents of a graphics image that is too large for the window, select the SIXEL scrolling option "Enable." When the graphics image reaches the bottom of the page, it will scroll upward until the entire image has been written to the screen.

The default is "Disable"; sixel graphics will not scroll.

Text cursor

Selecting this option invokes a menu with the following options:

- Enable (the default)
- Disable

This option specifies whether the text cursor is displayed. The default is "Enable"; the text cursor is displayed.

Selecting Enable invokes a menu with the following options:

- Blinking (the default)
- Non-blinking

This option specifies whether the text cursor is blinking or non-blinking. The default is "Blinking"; the text cursor blinks.

Transmission mode

Selecting this option invokes a menu with the following options:

- 8 bit controls (the default)
- 7 bit controls

The default is "8 bit controls," which indicates that the VT220 terminal window uses eight-bit ASCII character codes to interpret characters.

VT terminal type

Selecting this option produces a menu with the following options:

- VT52
- VT100
- VT220 (the default)

If you change the default, the new setting takes effect when the next terminal emulator window is created. For example, if you select "VT52," the next terminal emulator window that you invoke emulates the escape-sequence features of a VT52 terminal. However, the label in the window banner is still "VT220."

Warning bell

Selecting this option invokes a menu with the following options:

- Enable (the default)
- Disable

The "bell" is the beep sound made by the keyboard; for example, when some errors occur or messages arrive. This option lets you disable the sound.

The default is "Enable"; the warning bell sounds.

The Workstation Options Menu

2.4.10 Workstation Type

Selecting this option displays the following three options:

- Monochrome (bitonal) system—Black and white (bitonal)
- Intensity system—Shades of grey
- Color system—Full color

A check mark indicates the current setting. The workstation type must be set correctly in order for the color setup and applications to work correctly.

2.4.11 Use Default Settings

Selecting this option restores the setup features to their original defaults (as packaged by Digital). You will not lose site-specific settings that you have saved with the "Save current settings" option unless you select "Save current settings" again after selecting "Use default settings."

2.4.12 Restore Last Saved Settings

Select this option if you change your mind about settings you made but have not yet saved the settings. Selecting this option resets settings to their state at startup or when "Save the current settings" was last selected.

2.4.13 Save the Current Settings

Selecting this option stores the changes you made so they remain in effect for the next startup or reboot.

2.4.14 Exit This Menu

Selecting this option erases the Workstation Setup menu.

See Appendix B for information on additional VT220 attributes that are not included in the Workstation Setup menu.

2.5 Disabling the Workstation Setup Options Menu Attributes

NOTE: You need system privileges to modify these attributes.

You can disable one or more of the setup options to discourage another user from changing options you want unchanged. For each option you want to disable, use the following format:

```
$ DEFINE/SYSTEM/EXEC (Logical name) "FALSE"
```

The logical names and the option each one controls are shown in the following table:

Logical name	Option Controlled
UISBG\$AUTOLOGIN	Automatic login
UISBG\$COLOR_SETUP	Color display setup
UISBG\$KEYBOARD_SETUP	Keyboard setup
UISBG\$POINTER_SETUP	Pointer setup
UISBG\$USER_SETUP	Preferred color setup
UISBG\$PRINTER_SETUP	Printer setup
UISBG\$SCREEN_SAVER	Screen saver period
UISBG\$TEK_SETUP	TEK4014 terminal attributes
UISBG\$VT_SETUP	VT220 terminal attributes
UISBG\$WS_TYPE	Workstation type
UISBG\$DEFAULT	Use default settings
UISBG\$RESTORE	Restore last saved settings
UISBG\$SAVE	Save current settings

For example, to disable the "Preferred color setup," after the \$ prompt type:

```
DEFINE/SYSTEM/EXEC UISBG$USER_SETUP "FALSE"
```

The logical name takes effect the *next* time you activate the Workstation Setup Menu.

You can modify the procedure SYS\$MANAGER:SYSTARTUP.COM to define the logical names you want to use as defaults. You must define these logical names systemwide, as shown.

2.6 Modifying the Workstation Options Menu Attributes

NOTE: You need system privileges to modify these attributes.

You can modify the Workstation Options menu to include user-defined options. For example, you can add a menu option that invokes an application.

NOTE: The facility described in this section might not remain in the same form from release to release of the VMS Workstation Software. It is described only for your convenience and is not supported by Digital.

You add menu options (or change existing ones) by editing SYS\$MANAGER:UISBG.DAT and then rebooting the system. When VWS\$DISPLAYMGR starts up, it reads the commands in UISBG.DAT to determine the content of the Workstation Options Menu. UISBG.DAT includes a template (commented out by exclamation marks) in which you can substitute an application of your own.

The file also includes an option for invoking a VT220 terminal-emulator window without automatic login. This option allows you to choose between automatic login and interactive login without altering the Workstation Setup menu. Edit the file and remove the exclamation marks.

In addition, the file includes an option for creating VT240 REGIS windows with or without the automatic login option.

The Workstation Options Menu

You need to reboot the system to initialize the new menu.

The commands you use in UISBG.DAT are:

- **TITLE**—Specifies a character string to appear as the title in the menu banner. The string must be enclosed in double quotes. The default title is "Workstation Options."

The following two qualifiers are used with **TITLE** to specify the character fonts used in the menu:

- **/INSTRUCTION_FONT**—Specifies the font to be used for text written by the **INSTRUCTION** command (such as the instructions for selecting an option)
- **/CHOICE_FONT**—Specifies the font to be used for text written by the **CHOICE** command (the menu options)
- **SPACE**—Specifies a blank line to be inserted in the menu
- **INSTRUCTION**—Writes a line of text, such as the instructions for selecting a menu option. The text string must be enclosed in double quotes.
- **CHOICE**—Specifies an option to be included in the menu. The option name must be enclosed in double quotes.

The following qualifiers to **CHOICE** define the function the option performs:

- **/ROUTINE=routine**—Can be any of the following:

UISBG\$CREATE_TERMINAL	Creates a terminal-emulator window, ignoring the setting of the automatic login setup attribute
UISBG\$AUTOLOGIN_TERMINAL	Creates a terminal-emulator window. If automatic login is enabled in the Workstation Setup menu, the user is logged on to the terminal-emulator window automatically (without user input).
UISBG\$PRINT_SCREEN	Invokes the Print screen menu option
UISBG\$SETUP	Invokes the Workstation Setup menu
UISBG\$CREATE_PROCESS	Creates a process to run a specified application
UISBG\$EXIT	Invokes the exit function (deletes the menu)

- **/IMAGE=image**—Specifies the image to run in the created process, such as **SYS\$SYSTEM:UISHELP.EXE**. **SYS\$SYSTEM:LOGINOUT.EXE** must be used in conjunction with the routine **UISBG\$AUTOLOGIN_TERMINAL**.
- **/TITLE=string**—Specifies the title to be displayed in the terminal-emulator window.

The Workstation Options Menu

- **/TERMINAL=tt**—Specifies the terminal type for a terminal-emulator window invoked by the routines `UISBG$AUTOLOGIN_TERMINAL` and `UISBG$CREATE_TERMINAL`. The terminal options are the following:
 - TK For Tektronix 4010/4014 terminal emulator
 - WT For VT220 terminal emulator
- **/PLANE_COUNT=n**—Specifies whether a VT240 or a VT220 window is created. $n=0, 1, 2, 3$, and so on. To implement a virtual color map of n colors, where n is 2^n colors, specify 1, 2, 3, or higher. ReGIS can then work. The default is 0, which creates a monochrome (bitonal) VT220 window.
- **/INPUT=input-spec**—specifies the command input for a process created by the routine `UISBG$CREATE_PROCESS`. You can specify `NLA0:` to designate a null device. For `TEK4125` window creation it is necessary to specify the command `/INPUT=SYS$MANAGER:VWS$TEK4125.COM`.
- **/OUTPUT=output-spec**—specifies the output for a process created by the routine `UISBG$CREATE_PROCESS`. You can specify `NLA0:` to designate a null device.
- **/ERROR=error-spec**—specifies the output for errors generated by the routine `UISBG$CREATE_PROCESS`. You can specify `NLA0:` to designate a null device.
- **/DEFAULT**—determines the position of the menu on the VAXstation screen. If `/DEFAULT` is included, the menu appears with the specified option at the location of the pointer. If `/DEFAULT` is omitted, the menu appears in the lower left-hand corner of the screen.

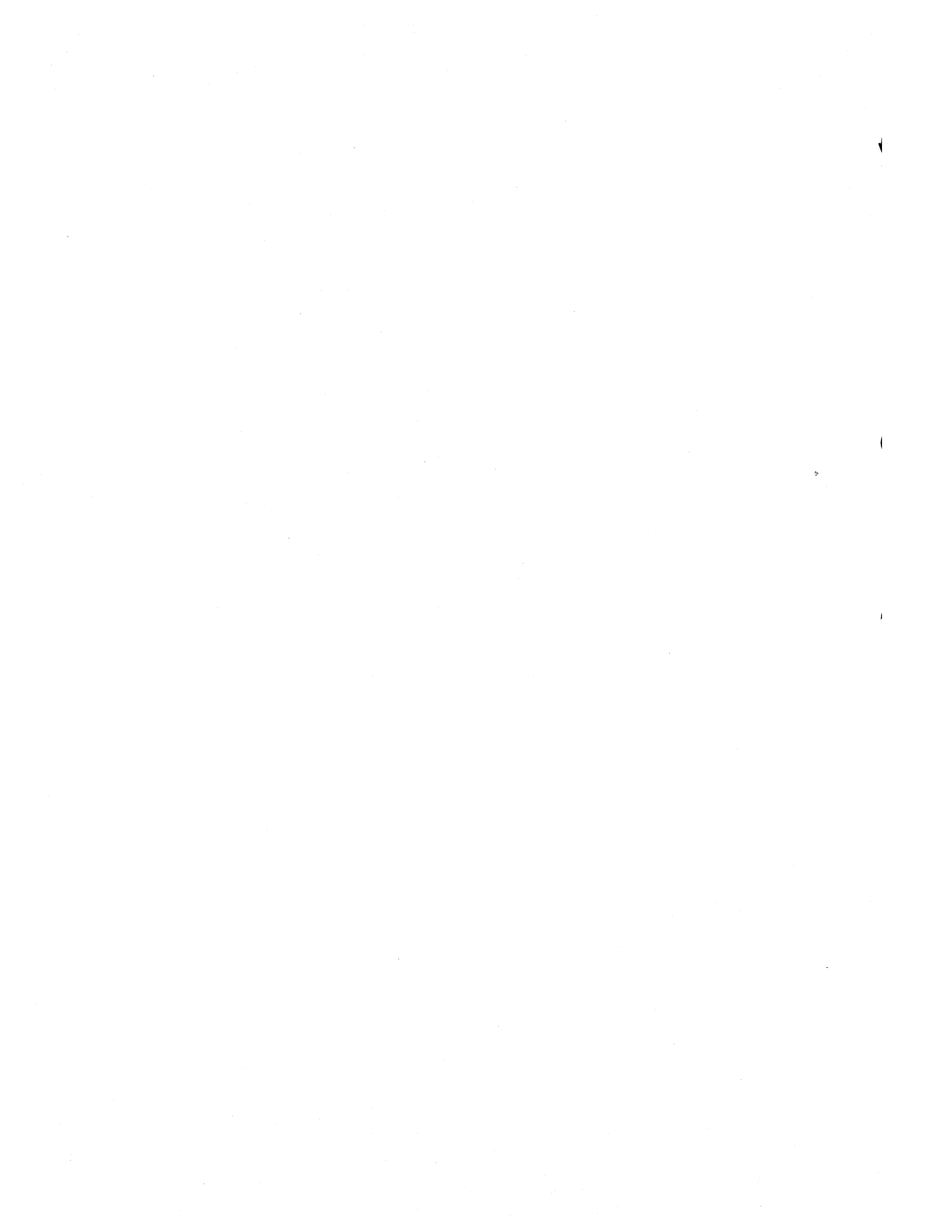

3

Using Windows

This chapter provides information about using windows on the VAXstation. The following topics are discussed:

- Logging on to a terminal-emulator window
- Using the Window Options menu
- Pushing and popping windows
- Resizing a window
- Cycling the keyboard
- Moving a window
- Copying and pasting between windows

For information on managing window memory (and performing other VAXstation tuning operations), see the *VWS Installation Guide*.

3.1

Logging on to a Terminal-Emulator Window

The Workstation Options menu offers two types of terminal emulators:

- VT220
- Tektronix 4010/4014

Section 2.2 describes the VT220 terminal characteristics that are emulated by the VMS Workstation software. Section 2.3 describes Tektronix 4010/4014 terminal emulation. To use VT220 terminal emulation, select "Create new VT220 window" from the Workstation Options menu.

After you invoke a terminal-emulator option, the window that appears has the keyboard connected to it automatically. The new window displays the user name prompt for you to log on.

Figure 3-1 shows a new VT220 terminal-emulator window.

Figure 3-1 VT220 Emulator Window with User Name Prompt

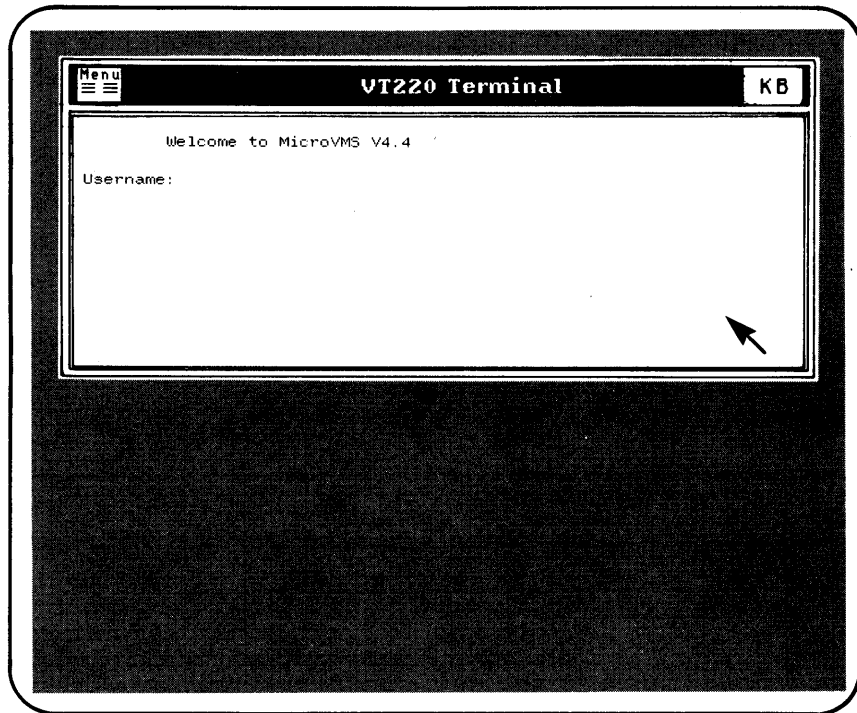

ZK-4054-85

Log on under the user name and password assigned you by your system manager. By default, you have 30 seconds to log on before the window disappears.

NOTE: If automatic login is enabled, you are only prompted for login information the first time you invoke a terminal-emulator window. See Section 2.4.1 for more information on automatic login.

You can position windows on the screen as you create them. The newly created window always appears at the location of the Workstation Options menu.

You can create as many windows on the screen as your system resources allow. For example, you can select "Create new VT220 window" several times, each time using the same or different accounts. Windows can overlap each other and you can run different applications in different windows, all at the same time. However, the keyboard can only be connected to one window at a time. An application continues to run whether or not the keyboard remains attached.

NOTE: If your system crashes frequently, or if your processes are being deleted when you have a large number of windows on your screen, insufficient memory might be allocated for use by windows.

You can change the amount of memory allocated to windows, or *window memory size*, to support more or fewer windows, as described in the *VWS Installation Guide*. Remember, the system regards an icon as a full sized window.

The terminal-emulator window has a *banner*—the wide portion of the border at the top of the window, containing the title. By default, the banner is black. On color and intensity systems, however, you can alter the color of the banner just as you would any other color on your screen (see Section 2.4.2). For simplicity, any discussion of the banner in this section is in terms of black and white.

The banner contains a symbol called an *icon* at each end:

- The Menu icon, at the left end of the banner
- The KB (keyboard) icon, at the right end of the banner

The menu icon lets you select the Window Options menu. By placing the pointer over the Menu icon and clicking the SELECT button, you can invoke a menu that lets you perform various window functions, such as changing the size of the window. Figure 3-2 shows the Window Options Menu icon:

Figure 3-2 Menu icon on Window Banner

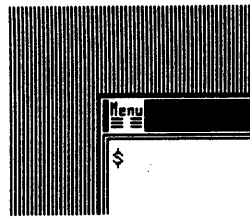

ZK 5410-86

See Section 3.2 for a complete description of the Window Options menu.

If the keyboard is *connected* to a window, you can use it to enter characters into that window. If the keyboard is connected to a window, the KB icon consists of black letters against a white background. Figure 3-3 shows the KB icon as it appears with the keyboard attached:

Figure 3-3 Banner with KB Icon, Black on White, for Attached Keyboard

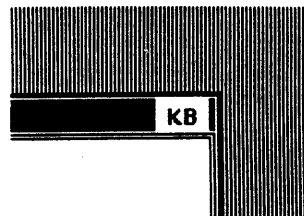

ZK 5409-86

Figure 3-4 Banner with KB Icon, White on Black, for Unattached Keyboard

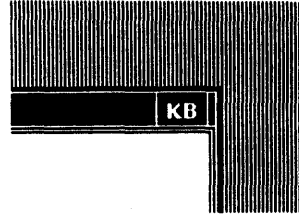

ZK 5408.86

When you connect to another window, the KB icon in the disconnected window reverses to white letters against a black background. Figure 3-4 shows the KB icon as it appears *without* the keyboard attached:

3.2 Window Options Menu

You can use the Window Options menu to manipulate windows on the screen. To select the Window Options menu, move the pointer to the Menu icon in the banner of the window you want to change. Press the SELECT button. A menu appears, as shown in Figure 3-5.

Figure 3-5 Window Options Menu

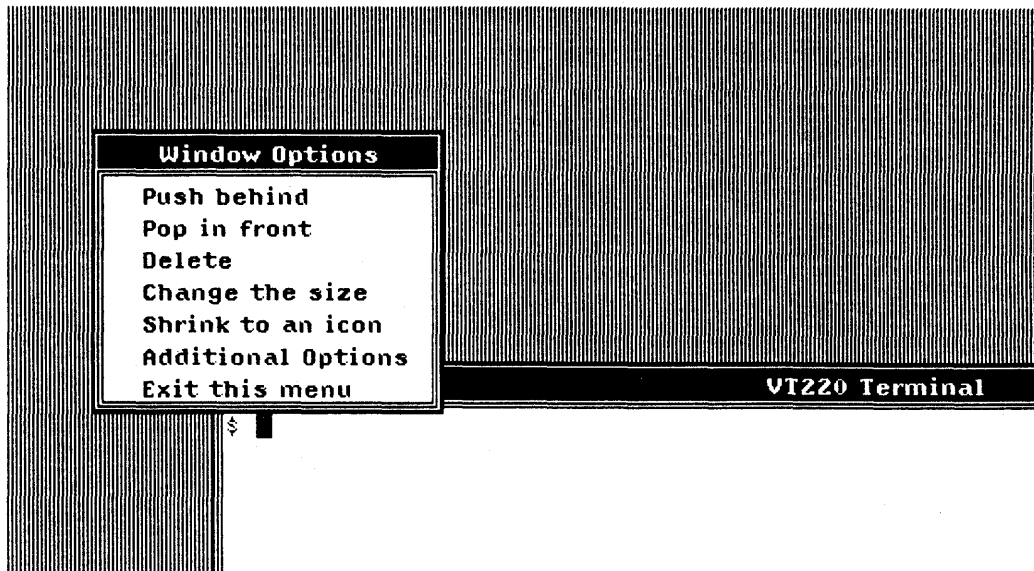

ZK 5412.86

Again, use the pointer to select the appropriate option for the task you want to perform. The options are:

NOTE: You can also manipulate VT220 terminal emulator windows by using logical names and escape sequences. For more complete information, see Appendix B.

3.2.1 Push behind

Selecting this option moves the selected window to the background of the display (in other words, under any windows it was covering).

3.2.2 Pop in front

Selecting this option moves the selected window to the foreground of the display.

3.2.3 Delete

Selecting this option erases the window from the screen and stops the associated image. For emulated terminals, it stops the associated process.

The function of the Delete option can be altered by an application. See the *VMS Workstation Graphics Programming Guide* for more information.

3.2.4 Change the size

Selecting this option lets you resize the window. An outline with blinking "lights" appears, superimposed over the original window border, and the shape of the pointer changes to that of an arrowhead.

Move the pointer to any position along the outline and hold down the SELECT button; the blinking lights disappear and the outline becomes a *stretchy box* (still superimposed over the original window). Move the pointer until the stretchy box conforms to the desired size; then release the SELECT button. The stretchy box and the original window disappear and are replaced by a new window containing the contents of the original.

If you have already selected the resize option and decide you do not want to continue, you can cancel the operation by placing the pointer at any position on the outline and clicking the SELECT button.

The function of the resize option can be altered by an application.

For information on an alternate way to resize windows, see Section 3.5.

3.2.5 Shrink to an icon

Selecting this option replaces the associated window with an icon. An icon represents a viewport that has been moved offscreen. Although the icon appears small, it uses system resources as does the offscreen viewport. Think of an icon as an additional window.

Icons provide a convenient way to make room on the screen without deleting windows. The icon includes a border and the title from the window banner. For terminal-emulator windows, the icon also includes the process name associated with the window and can include a picture of a monitor and keyboard.

If a window represented by an icon receives data, a message can appear within the icon to show that "New Data" has been received. Refer to Appendix B for the logical names you can use to access these and other optional features of the VT220 emulator.

Figure 3-6 shows a VT220 terminal-emulator icon next to the banner of another VT220 terminal-emulator window.

Figure 3-6 Terminal Emulator Icon

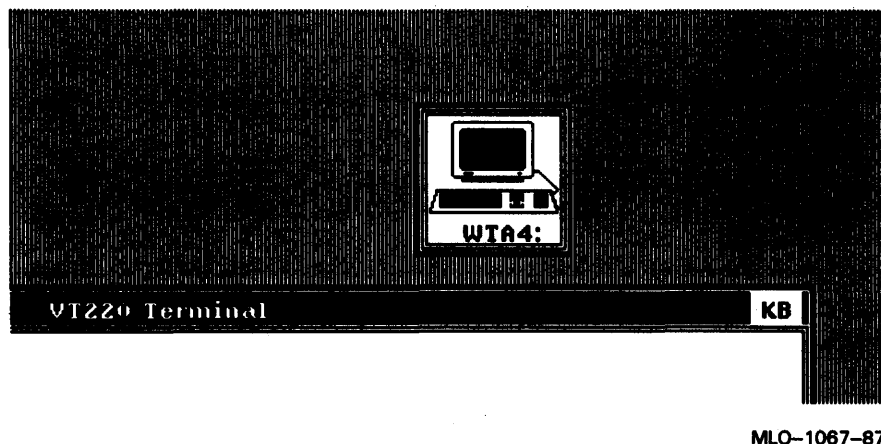

You can use the pointing device to move or pop the icon, just as you would any other bordered window on the screen.

To restore and connect the keyboard to the associated window, move the pointing device to any point on or within the border of the icon; then click the SELECT button. The window reappears at its most recent location on the screen, regardless of icon placement.

Although the default placement of the icon is at the lower left corner of the screen, the icon "remembers" its most recent placement. However, if a window or icon is partially offscreen when you shrink or restore it, the window or icon cannot be restored with any part offscreen. Instead, it reappears on the screen in its entirety at the position closest to its previous placement.

NOTE: The function of the "Shrink to an icon" option can be altered by an application.

For a VAXstation GPX using VT220 terminal-emulator windows, you can reduce offscreen memory demands to improve performance by modifying (if you have system privileges) the system file SYS\$MANAGER:SYLOGIN.COM or by typing at the \$ DCL prompt:

```
SET TERMINAL/NOREGIS  
and  
SET TERMINAL/NOSIXEL
```

NOTE: This does not mean the terminal cannot perform ReGIS or sixel operations. It means VMS does not recognize the terminal as a ReGIS or sixel device.

CAUTION: A VT220 terminal-emulator window on a terminal that has been set to NOREGIS and NOSIXEL loses graphics when shrunk to an icon. Choose this option *only* if you are using only text in the terminal-emulator window.

3.2.6 Additional Options

This option is reserved for application use.

For VT220 terminal-emulator windows, this option provides the following terminal-setup features:

- Display setup
- General Setup
- Keyboard setup
- Clear display
- Reset terminal
- Use default settings
- Exit from this menu

For Tektronix 4010/4014 terminal-emulator windows, this option provides no terminal-setup features.

3.2.7 Exit From This Menu

Selecting this option erases the Window Options menu.

If a menu option is turned off (for example, by an application), it is displayed in grey characters and cannot be highlighted or selected.

3.3 Cycling the Keyboard

When you *cycle* the keyboard, you switch its connection from one window to another.

You can cycle the keyboard among as many windows as you have by using either a pointing device or the CYCLE function key (**F5**).

Connect to a different window with the pointer as follows:

- 1 Move the pointer to any point within the border (including the banner) of the window containing the process you want.
- 2 Click the SELECT button.
- 3 The KB icon on the banner displays black letters against a white background, showing that the keyboard is connected to that window. If that window was underneath other windows, it pops to the top.

An inactive terminal-emulator window "remembers" its cursor position. When a window is disconnected from the keyboard, the cursor position is marked by a nonblinking cursor outline.

In addition to using the pointer, you can switch the keyboard between windows by pressing the F5 (cycle) function key. Each time you press the key, another window pops to the foreground of the display to become the active window.

3.4 Moving a Window

You might want to move windows on the screen to more convenient locations, for example, to avoid blocking one or more of them.

Using the mouse, you can move a window to a different part of the screen as follows:

- 1 Move the pointer to any point on the border of the window.
- 2 Press and hold down the SELECT button.

The window disappears, leaving an outline of the window. If any other windows on the screen were occluded by the window you are moving, they are filled in (thus, they provide a reference point for positioning the window).

- 3 Move the pointer steadily until the outline is where you want the window to be.
- 4 Release the SELECT button. The window reappears in the new place with its previous contents intact.

NOTE: You can move a window so that only a small part of it appears on the screen. Note, however, that moving a window partially off the screen might affect the scrolling rate and the drawing rate within that window.

3.5 Changing Window Size with DCL

As an alternative to resizing a window with the Window Options menu, you can change the size of VT220 terminal windows with the DCL command `SET TERMINAL/WIDTH=n/PAGE=n`. With this command, you can specify the exact columns and lines that you want in your terminal window.

The default size for a VT220 window is 80 columns wide and 24 lines long (that is, `WIDTH=80, PAGE=24`). To change the page size to 45 lines, for example, use the following command:

```
$ SET TERMINAL/PAGE=45
```

3.6 Copying and Pasting Between Terminal-Emulator Windows

3.6.1 Description

Copy and Paste functions have been added to the VT200 terminal emulator for VWS V3.2. This functionality is specific to the terminal-emulator windows and is not available to other UIS windows.

The two operation modes are:

- Transparent
- Programmed

3.6.2 Transparent Mode

Transparent mode operations can be selectively enabled and disabled for each terminal-emulator window. The default can be established by:

Assigning a logical name that is evaluated during a terminal reset. (See Appendix B for the logical names.)

Using an escape sequence under program control

NOTE: Copy and Paste functions are independent and can be individually enabled and disabled.

Transparent mode provides application-transparent (noncooperating) copy and paste functions between terminal-emulator windows. An area of text is selected using the locator (mouse or tablet) and outlining the area with a graphic "rubberband box." The text within the box can be transmitted later to the host as keyboard data using the mouse.

NOTE: Transparent mode is not available when the terminal is in ANSI locator input mode.

3.6.3 Programmed Mode

Programmed mode provides a set of escape sequences to load and transmit the Paste Buffer under program control. Combined with the ANSI locator sequences, applications can do their own Copy and Paste operations using the system-wide Paste Buffer.

3.6.4 Human Interface

By default, the M2 and M3 locator buttons control the Copy and Paste functions. This assignment can be reversed by a logical name assignment that is evaluated during terminal reset. (See Appendix B for a description of the logical.) M1 always cancels a Copy operation in progress.

3.6.5 Button Operation

Pressing any button causes the terminal-emulator window to be popped if it is occluded and the KB to be assigned if enabled and not attached.

To copy text from a window, do the following:

- 1 Move the cursor to the beginning of the text.
- 2 Click the SELECT button. An outlined rectangle replaces the cursor. This rectangle is one corner of the "select" area.
- 3 Move the mouse to "rubberband" the rectangle around the area you want to select for copying. You can click the M1 (Select) button to cancel the operation. (See Table 3-1 for more information.)
- 4 Click the Copy (M3) button a second time. This causes the text within the rectangular area to be copied to the Paste Buffer. The rectangle disappears and the normal blinking cursor reappears.

To paste text into a window, do the following:

- 1 Move the cursor in the "target" window to the location where you want the copied text to begin.
- 2 Click the Paste button. The data in the Paste Buffer is sent to the active terminal-emulator window as keyboard data.

NOTE: All escape sequences and control characters, other than BELL, BS, HT, LF, FF and CR, are stripped from the Paste Buffer and are not copied.

Table 3-1 shows buttons and their corresponding functions:

Table 3-1 Buttons and Their Corresponding Functions

Button	Functions
M1 (Left ¹)	Select (Cancel Mark)
M2 (Center)	Mark/Copy
M3 (Right ¹)	Paste

¹Right-hand setup (default)

Table 3-2 shows logical names, their corresponding functions, and enabling DEFAULT command:

Table 3-2 Logical Names, Functions, and Enabling DEFAULT Commands

Logical names	Function	Enabling DEFAULT Command
UIS\$VT_ENABLE_COPY	Enables transparent Copy	"TRUE"
UIS\$VT_ENABLE_PASTE	Enables transparent Paste	"TRUE"
UIS\$VT_PASTE_FORMAT	Format for transparent mode Paste	0 = Graphic characters plus BELL, BS, HT, LF, FF and CR (default) 1 = All data (unfiltered)
UIS\$VT_BUTTON_MAP	Locator button assignment	0 = M2:Copy, M3:Paste (default) 1 = M3:Copy, M2:Paste

3.6.6 Paste Buffer Format

The Paste Buffer is a 16kb global buffer. It is interlocked to prevent concurrent access,¹ that is available to any terminal.

The transparent Copy operation causes the text within the selected rectangle to be copied into the paste buffer, including control sequences to select character sets and graphic rendition. All lines except the last have a <CR> appended. Unwritten¹ character positions at the end of each line are trimmed.

The Copy-to-Paste-Buffer control sequence (DECCTPB) can copy any character data (0-255) to the Paste Buffer. The data is encoded as hex pairs.

¹ The VWS emulator can distinguish between character cells that are normal rendition spaces and cells that have not had data written to them. Unwritten character cells that precede the last graphic data on the line are converted to spaces.

3.6.7 Paste Operation

The Paste operation transfers the contents of the Paste Buffer to the terminal input buffer. During this operation, the Paste buffer is locked and cannot be accessed by another Copy or Paste operation. The buffer can be filtered to allow only the graphic character data and BELL, BS, HT, LF, FF and CR controls. The filtering removes escape, control, device and operating sequences.

If flow control (HOSTSYNCH) is enabled for the terminal, a Paste Buffer larger than the terminal typeahead buffer can be transmitted.

NOTE: If flow control is not enabled, data overruns can occur from Paste Operations.

A

VAXStation Support for Tektronix 4010/4014 Terminals

This appendix describes the features of industry-standard Tektronix 4010/4014-based software that are emulated by the VAXstation. The information in this appendix assumes that you have a working knowledge of Tektronix 4010/4014 functions.

Tektronix 4010/4014 terminal emulation supports features of Tektronix 4010/4014 terminals that can be transferred from direct-view storage tube technology to the raster-scan technology used by the VAXstation. It also supports industry-standard Tektronix 4010/4014 software packages.

This appendix describes known differences between Tektronix 4010/4014 and VAXstation support of Tektronix 4010/4014.

A.1 Implementation

Tektronix 4010/4014 terminal emulation supports the following modes and functions:

- Alpha mode—Processes text characters
- Graph mode—Processes vectors from endpoints defined by absolute coordinate values
- Point plot mode—Similar to graph mode except that only the points specified by the absolute coordinate values are plotted; no vector is drawn between the points
- Graphics input mode—Uses local cross-hair cursor for selecting items
- Strap options—Supports strap options as Workstation Setup options. (Select these options as described for Tektronix 4010/4014 terminal attributes in Section 2.4.)
- Control characters—Uses ASCII control characters to define actions to be taken by the terminal
- Escape sequences—Supports escape sequences that control and/or define Tektronix 4010/4014 functions
- Bypass condition—Inhibits terminal from responding to data echoed by the host

A.2 Implementation Restrictions

Because of the differences between direct-view and raster-scan display technologies, some functions are not implemented in the VAXstation or are implemented in a limited fashion. A description of these limitations follows.

- 1 A fallout of storage tube technology is write-through mode, where images are drawn on the tube, but not retained. These images need to be refreshed to be visible; their intensity depends on the refresh rate. In Tektronix 4010/4014 series terminals, write-through can be used for alpha mode characters as well as for graphic images. Write-through cannot be implemented by using the raster-scan technology of the VAXstation.
- 2 The Tektronix 4010/4014 Enhanced Graphics Module (EGM) option provides special features. The VAXstation implements a number of the features available through the EGM option. However, special point plot and incremental plot features are not implemented in the VAXstation.

A.3 Screen Addressing

Tektronix 4010/4014 series terminals use Tekpoints as units of screen addressing. By default, there is a 1024 X 820 addressable Tekpoint matrix. The default matrix is used in graphics input (GIN) mode.

A.4 Setup Support

Tektronix 4010/4014 terminals have four strap options that you can select by repositioning jumper wires on the terminal circuit cards. The VAXstation supports the Ignore Del and Ignore GIN terminators.

A.5 ASCII Character Codes

Table A-1 shows the 7-bit ASCII codes.

VAXStation Support for Tektronix 4010/4014 Terminals

Table A-1 7-Bit ASCII Codes

8	9	10	11	12	13	14	15	COLUMN	ROW	
1 0 0 0	1 0 0 1	1 0 1 0	1 0 1 1	1 1 0 0	1 1 0 1	1 1 1 0	1 1 1 1	b8 b7 b6 b5 b4 b3 b2 b1		
	200 128 80	DCS 220 144 90	240 160 A0	° 260 176 80	À 300 192 C0	à 320 208 D0	á 340 224 E0	æ 360 240 F0	0 0 0 0	0
	201 129 81	PU1 221 145 91	ì 241 161 A1	± 261 177 81	Á 301 193 C1	Ñ 321 209 D1	á 341 225 E1	ñ 361 241 F1	0 0 0 1	1
	202 130 82	PU2 222 146 92	é 242 162 A2	2 262 178 82	Â 302 194 C2	Ò 322 210 D2	â 342 226 E2	ò 362 242 F2	0 0 1 0	2
	203 131 83	STS 223 147 93	£ 243 163 A3	3 263 179 83	Ã 303 195 C3	Ó 323 211 D3	ã 343 227 E3	ó 363 243 F3	0 0 1 1	3
IND	204 132 84	CCH 224 148 94	ä 244 164 A4	µ 264 180 84	Ä 304 196 C4	Ö 324 212 D4	ä 344 228 E4	ö 364 244 F4	0 1 0 0	4
NEL	205 133 85	MW 225 149 95	¥ 245 165 A5	µ 265 181 85	Å 305 197 C5	Õ 325 213 D5	å 345 229 E5	õ 365 245 F5	0 1 0 1	5
SSA	206 134 86	SPA 226 150 96	¶ 246 166 A6	¶ 266 182 86	Æ 306 198 C6	Ö 326 214 D6	æ 346 230 E6	ö 366 246 F6	0 1 1 0	6
ESA	207 135 87	EPA 227 151 97	§ 247 167 A7	· 267 183 87	Ç 307 199 C7	œ 327 215 D7	ç 347 231 E7	œ 367 247 F7	0 1 1 1	7
HTS	210 136 88	230 152 98	 250 168 A8	 270 184 88	È 310 200 C8	Ø 330 216 D8	è 350 232 E8	ø 370 248 F8	1 0 0 0	8
HTJ	211 137 89	231 153 99	© 251 169 A9	1 271 185 89	É 311 201 C9	Ù 331 217 D9	é 351 233 E9	ù 371 249 F9	1 0 0 1	9
VTS	212 138 8A	232 154 9A	ª 252 170 AA	º 272 186 8A	Ê 312 202 CA	Ú 332 218 DA	ê 352 234 EA	ú 372 250 FA	1 0 1 0	10
PLD	213 139 8B	CSI 233 155 9B	« 253 171 AB	» 273 187 8B	Ë 313 203 CB	Û 333 219 DB	ë 353 235 EB	û 373 251 FB	1 0 1 1	11
PLU	214 140 8C	ST 234 156 9C	¼ 254 172 AC	¼ 274 188 8C	Ì 314 204 CC	Ü 334 220 DC	ì 354 236 EC	ü 374 252 FC	1 1 0 0	12
RI	215 141 8D	OSC 235 157 9D	½ 255 173 AD	½ 275 189 8D	Í 315 205 CD	Ý 335 221 DD	í 355 237 ED	ÿ 375 253 FD	1 1 0 1	13
SS2	216 142 8E	PM 236 158 9E	¾ 256 174 AE	¾ 276 190 8E	Î 316 206 CE	ÿ 336 222 DE	î 356 238 EE	ÿ 376 254 FE	1 1 1 0	14
SS3	217 143 8F	APC 237 159 9F	¿ 257 175 AF	¿ 277 191 8F	Ï 317 207 CF	ß 337 223 DF	ï 357 239 EF	ÿ 377 255 FF	1 1 1 1	15

KEY

CHARACTER	ESC	33	OCTAL
		27	DECIMAL
		1B	HEX

ZK-1753-84

Table A-2 summarizes the ASCII character code functions supported in the four operational modes of the Tektronix 4010/4014 emulation.

Table A-2 ASCII Character Code Functions

ASCII Char.	Operational Mode Value			LCE Flag (note 1)
	Alpha	Graph	Bypass/GIN	
NUL				SET LCE
SOH				
STX				
ETX				
EOT				
ENQ				RETURN TERMINAL STATUS
ACK				
BEL	RING BELL	RING BELL	RING BELL	RING BELL
BS	MOVE ONE SPACE LEFT			MOVE ONE SPACE LEFT
HT	MOVE ONE SPACE RIGHT			MOVE ONE SPACE RIGHT
LF	MOVE ONE LINE DOWN	MOVE DOWN	MOVE ONE LINE DOWN	SET LCE (note 2)
VT	MOVE ONE LINE UP			MOVE ONE LINE UP
FF				ERASE AND HOME (PAGE)
CR	MOVE TO LEFT MARGIN	SET ALPHA AND LEFT	SET ALPHA AND LEFT	SET LCE (note 2)
S0				
S1				
DLE				
DC1				
DC2				
DC3				

ASCII Character Codes

(Continued on next page)
ZK-4670/1-85

Table A-2 (Cont.) ASCII Character Code Functions

ASCII Char.	Operational Mode Value			LCE Flag (note 1)
	Alpha	Graph	Bypass/GIN	
DC4				
NAK				
SYN				
ETB				
CAN				SET BYPASS
EM				
SUB				SET GIN AND BYPASS
ESC	SET LCE	SET LCE	SET LCE	SET LCESET LCE
FS	SET POINT PLOT	SET POINT PLOT	SET POINT PLOT	
GS	SET GRAPH & DARK VECTOR	DO A DARK VECTOR	SET GRAPH & DARK VECTOR	SET GRAPH & DARK VECTOR
RS				
US		SET ALPHA MODE	SET ALPHA MODE	SET ALPHA MODE
SPACE	MOVE ONE SPACE RIGHT	HIGH X OR HIGH Y		
!	PRINT CHARACTER	HIGH X OR HIGH Y		
"	PRINT CHARACTER	HIGH X OR HIGH Y		
#	PRINT CHARACTER	HIGH X OR HIGH Y		
\$	PRINT CHARACTER	HIGH X OR HIGH Y		
%	PRINT CHARACTER	HIGH X OR HIGH Y		
&	PRINT CHARACTER	HIGH X OR HIGH Y		
	PRINT CHARACTER	HIGH X OR HIGH Y		
(PRINT CHARACTER	HIGH X OR HIGH Y		
)	PRINT CHARACTER	HIGH X OR HIGH Y		
*	PRINT CHARACTER	HIGH X OR HIGH Y		
+	PRINT CHARACTER	HIGH X OR HIGH Y		

ZK-4670/2-85

Table A-2 (Cont.) ASCII Character Code Functions

.	PRINT CHARACTER	HIGH X OR HIGH Y	
-	PRINT CHARACTER	HIGH X OR HIGH Y	
.	PRINT CHARACTER	HIGH X OR HIGH Y	
/	PRINT CHARACTER	HIGH X OR HIGH Y	
0	PRINT CHARACTER	HIGH X OR HIGH Y	
1	PRINT CHARACTER	HIGH X OR HIGH Y	
2	PRINT CHARACTER	HIGH X OR HIGH Y	
3	PRINT CHARACTER	HIGH X OR HIGH Y	
4	PRINT CHARACTER	HIGH X OR HIGH Y	
5	PRINT CHARACTER	HIGH X OR HIGH Y	
6	PRINT CHARACTER	HIGH X OR HIGH Y	
7	PRINT CHARACTER	HIGH X OR HIGH Y	
8	PRINT CHARACTER	HIGH X OR HIGH Y	NOT CURRENTLY IMPLEMENTED
9	PRINT CHARACTER	HIGH X OR HIGH Y	NOT CURRENTLY IMPLEMENTED
:	PRINT CHARACTER	HIGH X OR HIGH Y	NOT CURRENTLY IMPLEMENTED
;	PRINT CHARACTER	HIGH X OR HIGH Y	NOT CURRENTLY IMPLEMENTED
<	PRINT CHARACTER	HIGH X OR HIGH Y	
=	PRINT CHARACTER	HIGH X OR HIGH Y	
	PRINT CHARACTER	HIGH X OR HIGH Y	
?	PRINT CHARACTER	HIGH X OR HIGH Y	LOW Y FOR GRAPH (note 3)

(Continued on next page)

ZK-4670/3-85

Table A-2 (Cont.) ASCII Character Code Functions

ASCII Char.	Alpha	Operational Mode Value		LCE Flag (note 1)
		Graph	Bypass/GIN	
@	PRINT CHARACTER	LOW X		
A	PRINT CHARACTER	LOW X		
B	PRINT CHARACTER	LOW X		
C	PRINT CHARACTER	LOW X		
D	PRINT CHARACTER	LOW X		
E	PRINT CHARACTER	LOW X		
F	PRINT CHARACTER	LOW X		
G	PRINT CHARACTER	LOW X		
H	PRINT CHARACTER	LOW X		
I	PRINT CHARACTER	LOW X		
J	PRINT CHARACTER	LOW X		
K	PRINT CHARACTER	LOW X		
L	PRINT CHARACTER	LOW X		
M	PRINT CHARACTER	LOW X		
N	PRINT CHARACTER	LOW X		
O	PRINT CHARACTER	LOW X		
P	PRINT CHARACTER	LOW X		
Q	PRINT CHARACTER	LOW X		
R	PRINT CHARACTER	LOW X		
S	PRINT CHARACTER	LOW X		
T	PRINT CHARACTER	LOW X		
U	PRINT CHARACTER	LOW X		
V	PRINT CHARACTER	LOW X		
W	PRINT CHARACTER	LOW X		

ZK 4670/4-85

Table A-2 (Cont.) ASCII Character Code Functions

X	PRINT CHARACTER	LOW X		
Y	PRINT CHARACTER	LOW X		
Z	PRINT CHARACTER	LOW X		
[PRINT CHARACTER	LOW X		
\	PRINT CHARACTER	LOW X		
]	PRINT CHARACTER	LOW X		
^	PRINT CHARACTER	LOW X		
_	PRINT CHARACTER	LOW X		
`	PRINT CHARACTER	LOW Y		NORMAL, SOLID
a	PRINT CHARACTER	LOW Y		NORMAL, DOTTED
b	PRINT CHARACTER	LOW Y		NORMAL, DOT-DASHED
c	PRINT CHARACTER	LOW Y		NORMAL, SHORT-DASHED
d	PRINT CHARACTER	LOW Y		NORMAL, LONG-DASHED
e	PRINT CHARACTER	LOW Y		Reserved
f	PRINT CHARACTER	LOW Y		for future
g	PRINT CHARACTER	LOW Y		use
h	PRINT CHARACTER	LOW Y		THICK, SOLID
i	PRINT CHARACTER	LOW Y		THICK, DOTTED
j	PRINT CHARACTER	LOW Y		THICK, DOT-DASHED
k	PRINT CHARACTER	LOW Y		THICK, SHORT-DASHED
l	PRINT CHARACTER	LOW Y		THICK, LONG-DASHED

(Continued on next page)

ZK-4670/5-85

Table A-2 (Cont.) ASCII Character Code Functions

ASCII Char.	Alpha	Operational Mode Value		LCE Flag (note 1)
		Graph	Bypass/GIN	
m	PRINT CHARACTER	LOW Y		Reserved for future use
n	PRINT CHARACTER	LOW Y		
o	PRINT CHARACTER	LOW Y		
p	PRINT CHARACTER	LOW Y		
q	PRINT CHARACTER	LOW Y		
r	PRINT CHARACTER	LOW Y		
s	PRINT CHARACTER	LOW Y		
t	PRINT CHARACTER	LOW Y		
u	PRINT CHARACTER	LOW Y		
v	PRINT CHARACTER	LOW Y		
w	PRINT CHARACTER	LOW Y		
x	PRINT CHARACTER	LOW Y		
y	PRINT CHARACTER	LOW Y		
z	PRINT CHARACTER	LOW Y		
{	PRINT CHARACTER	LOW Y		
	PRINT CHARACTER	LOW Y		
}	PRINT CHARACTER	LOW Y		
-	PRINT CHARACTER	LOW Y		
DEL		LOW Y or NO-OP (note 3)		SET LCE

NOTES:

1. The applicable ASCII character performs the function as listed when used as part of an escape sequence; LCE flag is an escape sequence introducer condition.
2. Filler CRs and filler LFs will not interfere.
3. In graph mode, the effect of DEL as a low Y character can be disabled by the DEL IMPLIES LOW Y option in graphics setup; if DEL cannot be used, the program can substitute ESC?, which will perform the same function as DEL.

ZK-4670/6-85

A.6 Escape Sequences

The following sections discuss various Tektronix 4010/4014 escape sequences and indicate which sequences are supported by the VAXstation.

A.6.1 Ignored Escape Sequences

Table A-3 lists the escape sequences for functions *not* implemented in Tektronix 4010/4014 terminal emulation.

Table A-3 Escape Sequences Not Implemented in Tektronix 4010/4014 Terminal Emulation

Escape Sequence	Function
ESC SO	Select alternate character set
ESC SI	Select ASCII character set
ESC p	Set solid vector pattern with write-through
ESC q	Set dotted vector pattern with write-through
ESC r	Set dot-dashed vector pattern with write-through
ESC s	Set short-dashed vector pattern with write-through
ESC t	Set long-dashed vector pattern with write-through
ESC u	Set solid vector pattern with write-through
ESC v	Set solid vector pattern with write-through
ESC w	Set solid vector pattern with write-through
ETB	Make copy
ESC FS	Special point plot
RS	Set incremental plot
ESC RS	Set incremental plot

A.6.2 Request Terminal Status

Request terminal status by invoking the following escape sequence:

```
1/11 0/5  
ESC ENQ
```

This escape sequence also sets the bypass condition. If alpha mode is in effect, the VAXstation sends terminal status and the address of the lower left corner of the alpha cursor. If graph mode is in effect, the terminal sends terminal status and the address of the current active position.

A.6.3 Select Bypass Condition

Select the bypass condition by using the following escape sequence:

```
1/11 1/8  
ESC CAN
```

Bypass condition inhibits the VAXstation from responding to any data echoed by the host.

A.6.4 Set Alpha Mode

Set alpha mode by using the following escape sequence:

```
1/11 0/12  
ESC FF
```

Besides setting alpha mode, the following also happens:

- The screen is erased.
- The current position is moved to top left corner.
- Margin 1 is activated.
- Bypass condition is cleared.

A.6.5 Set GIN Mode

Set GIN mode by using the following escape sequence:

```
1/11 1/10  
ESC SUB
```

A.6.6 Select Point Plot Mode

Select the point plot mode by using the following escape sequence:

```
1/11 1/12  
ESC FS
```

In a Tektronix 4010/4014-series terminal, this escape sequence sets the terminal to special point plot mode, a mode identical to point plot mode except that the electron beam intensity is programmable. Special point plot mode is not implemented in the VAXstation. As a fallback, ESC FS sets the terminal to point plot mode.

A.6.7 Select Character Size

Only one character size is currently supported. Any escape sequence that selects a different character size is ignored. The character size currently supported is 64 lines of 133 characters each.

Select the character size by using the following escape sequence:

```
1/11 3/11  
ESC ;
```

A.6.8 Select Vector Patterns

Table A-4 shows the type of patterns used for vector drawing and the escape sequences for each one:

Table A-4 Vector Patterns

Escape Sequence	Pattern	Intensity
1/11 6/0 ESC `	Solid	Normal
1/11 6/1 ESC a	Dotted	Normal
1/11 6/2 ESC b	Dot-Dashed	Normal
1/11 6/3 ESC c	Short-Dashed	Normal
1/11 6/4 ESC d	Long-Dashed	Normal
1/11 6/8 ESC h	Solid	Thick
1/11 6/9 ESC i	Dotted	Thick
1/11 6/10 ESC j	Dot-Dashed	Thick
1/11 6/11 ESC k	Short-Dashed	Thick
1/11 6/12 ESC l	Long-Dashed	Thick

A.6.9 Set LCE Flag

Set the LCE flag, an escape sequence introducer condition, by using any of the escape sequences shown in Table A-5:

Table A-5 LCE Flag Escape Sequences

1/11	7/15
ESC	DEL
1/11	0/0
ESC	NUL
1/11	0/13
ESC	CR
1/11	0/10
ESC	LF
1/11	1/11
ESC	ESC

A.6.10 Delete Character

Tektronix 4010/4014 terminals have a "DEL implies LOW Y" strap option, which is supported in graphic setup mode in the VAXstation. This option allows the ASCII code associated with the DEL control character to be a possible low Y value in Tektronix 4010/4014 series coordinate specifications.

Through this option, DEL can be enabled as low Y for graphics mode or disabled as low Y during graphics mode. Because this usage might conflict with some operating systems' usage of DEL for synchronization, Tektronix 4010/4014 terminal emulation accepts the following escape sequence as a functional substitute for the low Y coordinate value of DEL:

1/11	3/15
ESC	?

A.6.11 Miscellaneous Escape Sequences

Table A-6 lists escape sequences that have the same function as when only the control character is invoked:

VAXStation Support for Tektronix 4010/4014 Terminals

Table A-6 Miscellaneous Escape Sequences

Escape Sequence	Function
ESC BEL	Same as BEL
ESC BS	Same as BS
ESC HT	Same as HT
ESC VT	Same as VT
ESC GS	Same as GS
ESC RS	Same as RS
ESC US	Same as US

In addition, ESC FS performs the same function as FS because of a fallback condition in the VAXstation's Tektronix 4010/4014 terminal emulation.

A.7 Changing Operational Modes

After the user enters Tektronix 4010/4014 terminal emulation, characters are used to make transitions between the various operational modes. In some instances, escape sequences are used to change between modes.

Control characters or escape sequences used to change the operational mode of the VAXstation can be generated by the host.

Figure A-1 shows the four operating modes available in Tektronix 4010/4014 terminal emulation. Transitions between modes are represented by arrows. Shown with each arrow is the identification of the ASCII control characters (or escape sequences) that cause the mode transition.

Figure A-1 Tektronix Operating Modes

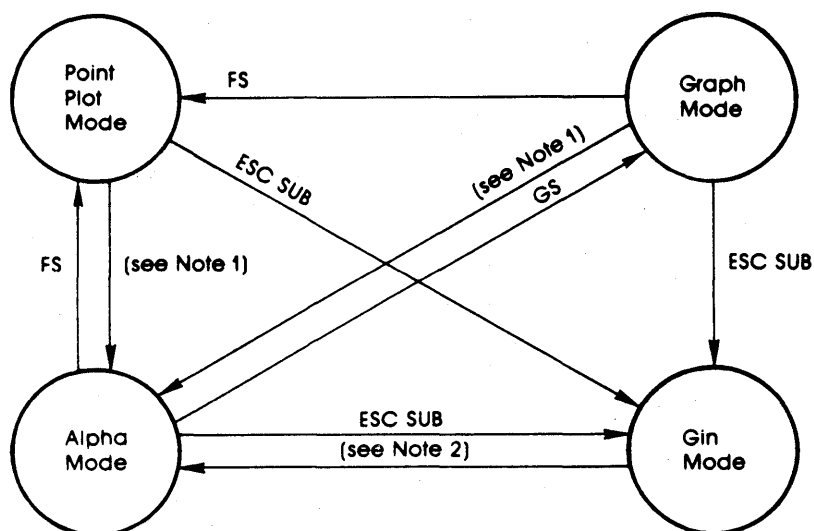

NOTES
1. US, ESC US, ESC FF, or NEXT SCREEN key;
2. CR, ESC, FF. See GRAPHIC INPUT (GIN) MODE section.

ZK-4212-85

A.8 Clearing the Screen

The Tektronix 4010/4014 series terminals have a "clear screen" key. The VAXstation uses the middle mouse button or **E6** on the keyboard.

A.9 Bypass Condition

When bypass condition is in effect, the VAXstation ignores any characters received from the host until bypass is disabled. This feature lets the terminal ignore its own transmissions if they are erroneously echoed by the host.

Bypass can be enabled either by keyboard input or from the host by using any of the following escape sequences:

- ESC CAN—Enables bypass condition, but performs no other function
- ESC ENQ—Enables bypass condition and requests status information
- ESC SUB—Enables bypass condition and places VAXstation in GIN mode

VAXStation Support for Tektronix 4010/4014 Terminals

Bypass is disabled upon receipt of any of the following escape sequences:

- BEL—Control character generating bell tone, if bell is enabled
- LF— Control character causing new line operation
- CR—Control character moving cursor to left margin and resetting VAXstation to alpha mode
- US—Control character resetting VAXstation from graph mode to alpha mode
- ESC FF—Escape sequence selecting alpha mode and clearing screen
- Mouse SELECT button click—Selecting alpha mode and clearing screen

A.10 Alpha Mode

In alpha mode, all characters received that are not ASCII control characters or escape sequence characters are displayed on the screen in the currently selected character size.

Control characters or escape sequences that are not valid Tektronix 4010/4014 commands or that are for functions not implemented are ignored.

Alpha mode is the default operational mode in Tektronix 4010/4014 terminal emulation.

A.10.1 Margin Processing

Margin processing refers to two-column character writing in alpha mode. Two margins are used in two-column writing: Margin 1 (located at the left edge of the display area) and Margin 2 (located at the center of each row in the display area). When rows of characters are being written from the left edge to the center of the display area, Margin 1 is active. When rows of characters are being written from the center to the right edge, Margin 2 is active.

Margin switching occurs automatically when the last row of characters has been filled for the currently active margin or when a line feed occurs at the last row of the display. When either condition is met, further character processing moves to the top row at the new margin: Margin 2 if Margin 1 was active or Margin 1 if Margin 2 was active.

Because Tektronix 4010/4014 series terminals are storage tube terminals, they cannot scroll. When printable characters are received in alpha mode without intervening control characters, the characters are written in the following manner:

- 1 Initial character processing begins at the top left corner of the screen and moves across the top row to the center of the screen.
- 2 When the end of a row is reached, character wrap occurs; the next character is written at the left edge of the next row down.
- 3 Rows of characters continue until Column 1 is filled.

- 4 Once the bottom row of column is filled, the next character is written at the top center of the screen. Subsequent characters are written from the center to the right edge of the screen, overstriking any existing characters.
- 5 As each row is filled, wrapping occurs to the middle of the next row, until Column 2 is filled.
- 6 When the last row of Column 2 is filled, wrapping begins again at the top row of Column 1 (the left edge of the screen).

Margin processing allows text writing in either one column or two columns. For one-column writing, clear the screen before wrapping to Margin 2 occurs. For two-column writing, insert CR and LF (or CR alone if selected in setup support for CR and LF) in each row before writing reaches Margin 2, so wrapping does not overstrike any characters.

A.10.2 Character Size

Only one character size is currently supported. Any escape sequence that selects a different character size is ignored. The character size currently supported is 64 lines of 133 characters each.

To select character size, use the following escape sequence:

```
1/11 3/11  
EXC ;
```

A.11 Graph Mode

In graph mode, vectors are drawn between specified absolute coordinate values, which are Tekpoint values mapped to the nearest corresponding VAXstation pixel. The vectors are drawn in the currently selected line pattern.

The Tektronix 4010/4014 with Oct EGM has a 1024 X 1024 square matrix with the high 25% of the four addresses above the top of the display area. Coordinates can be specified within this area, and despite being off screen, they are tracked accurately. As much of the requested vector is drawn as appears within the display area. The remainder of the vector are clipped.

In graph mode, any valid Tektronix 4010/4014 terminal escape sequences or control characters are acted on. Escape sequences and control characters that are not valid for Tektronix 4010/4014 functions, or that are for functions not implemented in the VAXstation, are ignored.

A.11.1 Line Patterns

Five basic line patterns can be used, with each pattern available as either normal or thick intensity. Table A-7 lists the patterns that can be selected, along with identification of the escape sequences required for each selection:

Table A-7 Line Patterns and Their Escape Sequences

Line Pattern	Escape Sequence
Solid (normal)	ESC ' (apostrophe)
Solid (thick)	ESC h
Dotted (normal)	ESC a
Dotted (thick)	ESC i
Dot-Dashed (normal)	ESC b
Dot-Dashed (thick)	ESC j
Short-Dashed (normal)	ESC c
Short-Dashed (thick)	ESC k
Long-Dashed (normal)	ESC d
Long-Dashed (thick)	ESC l (lowercase L)

A.11.2 Drawing Command

The control character GS is used to enter graph mode from alpha mode. In graph mode, GS defines the start of a vector draw.

In graph mode, vectors are not drawn from the active location when GS is invoked. The vector is drawn from the first coordinate value specified to the next value specified. If more than two coordinates are specified following a GS control character, each new vector is drawn from the last coordinate drawn to, to the next coordinate specified. For example:

GS A B C D

Vectors are drawn from point A to point B, from point B to point C, and from point C to point D. However, in the following command, two separate vectors are drawn, one from A to B, and another from C to D:

GS A B GS C D

A.11.3 Encoding Coordinates

Tektronix 4010/4014 terminal emulation supports 10-bit addressing. The Tekpoint matrix of the screen is defined as being 1024 X 820, with Tekpoints mapped to the nearest corresponding pixel.

Coordinates are encoded into four bytes. Table A-8 shows the transmission order of these bytes, and identifies their formats.

Table A-8 Coordinate Encoding Byte Values

Byte Name	Tag	Bits	Address Bits							
			7	6	5	4	3	2	1	
HI Y	0	1	5 MSB OF Y ADDRESS							
LO Y	1	1	5 INTERMEDIATE BITS OF Y ADDRESS							
HI X	0	1	5 MSB OF X ADDRESS							
LO X	1	0	5 INTERMEDIATE BITS OF X ADDRESS							

Tektronix 4010/4014 terminal emulation supports shortened address transmission. That is, when only parts of an address change, only certain bytes need be sent. The transmission rules for this shortened address capability are shown in Table A-9.

Table A-9 Shortened Address Capability Transmission Rules

Bytes Changed	HI Y	LO Y	HI X	LO X
HI Y	YES	NO	NO	YES
LO Y	NO	YES	NO	YES
HI X	NO	YES	YES	YES
LO X	NO	NO	NO	YES

A.12 Point Plot Mode

In point plot mode, no vectors are drawn. Instead, single pixels are turned on. The pixel turned on is the physical pixel most closely corresponding to the Tekpoint specified by absolute coordinate values.

Point plot mode values identical to the coordinate values are transmitted for graph mode.

As with graph mode coordinates, a coordinate not within the actual display area can be specified. However, coordinates so specified are not visible.

Point plot mode is entered from alpha or graph mode by using the FS control character. No other control characters or escape sequences are used for point plot mode functions. In the point plot mode, most valid Tektronix 4010/4014 escape sequences and control characters are acted on when received. Escape sequences or control characters that are not valid for Tektronix 4010/4014 functions or that are for functions not implemented in the VAXstation are ignored.

ESC FS also causes the VAXstation to enter point plot mode from alpha or graph mode. However, this is a fallback function. In Tektronix 4010/4014-series terminals, ESC FS normally selects a special point plot mode, identical to point plot mode, except that the beam intensity is programmable. Tektronix 4010/4014 terminal emulation does not implement special point plot mode.

Once in point plot mode, all coordinate values are transmitted without specifying FS (or ESC FS) again.

A.13 Graphics Input Mode

You invoke graphics input (GIN) mode by entering ESC SUB. The terminal enters a local mode in which the following occurs:

- The VAXstation cross-hair cursor appears, with the hairs intersecting at the current active position.
- Bypass condition is enabled.

Once in GIN mode, you can change the active position by using the mouse to reposition the cross-hair cursor over the position desired.

If ESC ENQ is received while the cross-hair cursor is being displayed, the address of the intersect point is sent automatically to the processor. This is followed by CR or CR and EOT (if selected by setup option). If the SELECT button (the left mouse button) is pressed, GIN mode is terminated with a space as the terminator character.

GIN mode can be terminated while the cross-hair cursor is being displayed, without transmitting to the computer. Command CR or ESC FF terminates GIN mode, switching the terminal to alpha mode. However, CR might leave the terminal in either Margin 1 or Margin 2 status, and ESC FF erases the display. It might be better to terminate by sending ESC ENQ and ignore the transmission at the computer.

You can also exit from GIN mode by using the keyboard. After you select active position (or if already correct on entering GIN mode), pressing any active key on the keyboard results in the following:

- The ASCII code of the key pressed is sent to the host.
- The coordinates of the cross-hair cursor at the time the key was pressed are sent to the host in 10-bit addressing format.
- The graphics cursor disappears from the screen.
- The VAXstation leaves GIN mode and enters alpha mode.

At this point, however, the VAXstation is still in bypass mode. Further keyboard input is necessary to get the VAXstation out of bypass. See the description of bypass condition in Section A.9 for identification of control characters and escape sequences you can use to terminate bypass.

B

Additional Features of the VT220 Terminal Emulator

This appendix describes how to use the VT220 terminal emulator to perform the following functions:

- 1 Redefine system-wide logical names
- 2 Define escape sequences
- 3 Format VT220 terminal-emulator mailbox messages

B.1 Optional Ways to Modify VT220 Terminal Emulator Features

The following subsections describe ways to modify VT220 terminal-emulator attributes other than by using the the Workstation Setup menu.

B.1.1 Redefining VT220-Emulator Logical Names

VWS defines a number of systemwide logical names that determine the behavior of the VT220 terminal emulator. You can redefine these logical names to suit your needs. For example, the following command redefines the logical name `UIS$VT_AUTO_WRAP_MODE` to wrap text within a VT220 terminal-emulator window when the right margin is reached.

```
$ DEFINE/SYSTEM UIS$VT_AUTO_WRAP_MODE TRUE
```

In this case, for the logical name to take effect you must define it *before* you create a window or execute a `SET TERMINAL` command.

You can modify the procedure `SY$MANAGER:SYSTARTUP_V5.COM` to define the logical names you want to use as defaults.

NOTE: You must define these logical names systemwide (using the DCL command `DEFINE/SYSTEM`).

Table B-1 lists the logical names you can define for the VT220 terminal emulator. It also lists the defaults and provides a description of each logical name.

Additional Features of the VT220 Terminal Emulator

Table B-1 VT220 Emulator Logical Names

Logical Name	Default	Description
UIS\$VT_ANSWERBACK	No string is defined	String, 0 to 40 characters Defines the text to be transmitted when an ENQ is received and Auto Answerback is enabled.
UIS\$VT_AUTO_ANSWERBACK	FALSE	Logical T/F If TRUE, the terminal transmits an answerback string in response to a ENQ (x05) character. If FALSE or undefined, no answerback can be generated.
UIS\$VT_AUTO_WRAP_MODE	FALSE	Logical T/F If TRUE, the terminal wraps text when the right margin is reached. If FALSE or undefined, the text does not wrap automatically.
UIS\$VT_CURSOR_KEY_MODE	TRUE	Logical T/F If TRUE, the arrow keys transmit the application-mode CSI sequences. If FALSE or undefined, the arrow keys transmit the SS3 arrow sequences.
UIS\$VT_ENABLE_MBX_EVENTS	FALSE	Logical T/F If TRUE, terminal emulator events cause messages to be written to associated terminal mailboxes. (See Section B.2.) If FALSE or undefined, the messages are not delivered.
UIS\$VT_ENABLE_OSC_STRINGS	FALSE	Logical T/F If TRUE, you can define escape sequences that modify VT200 terminal emulator features. (See Section B.1.2.) If FALSE or undefined, any escape sequences defined to modify VT220 terminal emulator features do not work.
UIS\$VT_LOCK_USER_FEATURES	FALSE	Logical T/F If TRUE, the following user-preference features cannot be altered by SET/RESET MODE escape sequences: AUTOREPEAT TAB STOPS If FALSE or undefined, the above user-preference features can be altered by SET/RESET MODE escape sequences.
UIS\$VT_NEW_LINE_MODE	FALSE	Logical T/F If TRUE, the terminal emulator causes all CR, LF, and VT characters to set the current position to the left margin and the next line. If FALSE or undefined, new-line mode is disabled.
UIS\$VT_TAB_STOPS		String, 0 to 168 characters Defines a TAB-stop ruler. The string should be formatted as follows: where no tab stop is desired, a blank character (space) should be used; where a tab stop is desired, any other character can be used. If this name is not defined, tabs are set by default for every 8 positions starting in Column 9.

Additional Features of the VT220 Terminal Emulator

Table B-1 (Cont.) VT220 Emulator Logical Names

Logical Name	Default	Description												
UIS\$VT_UDK_LOCK	UNDEFINED	<p>Logical T/F</p> <p>If TRUE, the terminal emulator does not let the current value of the user-definable keys (UDK) be altered. If FALSE or undefined, the UDKs can be altered by the host software.</p>												
UIS\$VT_FONT_DEFAULT		<p>80/132</p> <p>If 132 is specified (132-column font), the values 7 and 12 are used for the spacing- and point-size defaults respectively. By default, 9 and 14 are used (80-column font size).</p> <p>However, if the FAMILY, SPACING, and POINT logical names are also specified, they override UIS\$VT_FONT_DEFAULT.</p> <p>Table B-5 shows the FAMILY, SPACING and POINT defaults.</p> <p>NOTE: The specified fonts must be present in UISMEMFONTS.COM to be used. If they are not present, the terminal emulator tries to match the specified fonts with the fonts that are present. If no match can be found, the defaults are used.</p> <p>The following logical names are read whenever a Reset Terminal sequence is executed (implicitly at terminal window creation):</p> <p>ICON OPTIONS:</p>												
UIS\$ICON_PLACEMENT	6	<p>Icon Placement lets the default placement of icons be specified. The value is a bit-mask that corresponds to the placement attributes in UIS window creation.</p> <table style="margin-left: 20px;"> <thead> <tr> <th style="text-align: left;">Logical Value</th> <th style="text-align: left;">Icon Position</th> </tr> </thead> <tbody> <tr> <td>1</td> <td>Top</td> </tr> <tr> <td>2</td> <td>Bottom</td> </tr> <tr> <td>4</td> <td>Left</td> </tr> <tr> <td>8</td> <td>Right</td> </tr> <tr> <td>32</td> <td>Center</td> </tr> </tbody> </table> <p>For example, <i>UIS\$ICON_PLACEMENT 6</i> identifies the bottom-left (2 + 4).</p>	Logical Value	Icon Position	1	Top	2	Bottom	4	Left	8	Right	32	Center
Logical Value	Icon Position													
1	Top													
2	Bottom													
4	Left													
8	Right													
32	Center													
UIS\$VT_ENABLE_LIVE_ICON	TRUE	<p>The "live" icon is in fact a real terminal reduced to a 2x1 font size with no KB attached and resumes its original size and location when clicked on with the mouse. The icon must be a "fake" icon for this to work. Define fake icons as explicit or implicit by setting the terminal to /NOSIXEL/NOREGIS.</p>												

Additional Features of the VT220 Terminal Emulator

Table B-1 (Cont.) VT220 Emulator Logical Names

Logical Name	Default	Description
UIS\$VT_USE_FAKE_ICON	FALSE	Fake icons are a means of reducing UIS overhead while in the icon state. A fake icon is a text-only terminal in the sense that while an icon, any graphics on the screen is lost and only the text is preserved. No offscreen memory is consumed for the window while in a fake icon state. This logical name explicitly forces use of the fake icon state; setting the terminal /NOSIXEL/NOREGIS implicitly makes it a text-only terminal.
UIS\$VT_DISABLE_ICON_PICTURE	FALSE	The picture of a terminal in the terminal icon can be disabled by setting this to TRUE. The icon is then just the text portion. This is only valid when the live icon option is not being used.
UIS\$VT_ENABLE_ICON_UPDATE	TRUE	A <i>new data</i> notification can be made to the icon to alert the user. This notification is of the form <i>New Data</i> written to the screen of the terminal picture. This is only available when the live icon option is not being used.
UIS\$VT_COMPLEMENT_ICON	FALSE	The <i>New Data</i> notification can be changed from a text notification to a complement of the icon window colors. This is only available when the live icon option is not being used.
UIS\$VT_DEFER_ICON_UPDATE	TRUE	This option allows the <i>New Data</i> notification option to delay for one to two seconds after being shrunk to an icon. This allows the user to shrink to an icon by DCL command without an immediate <i>New Data</i> .
UIS\$VT_ENABLE_CUT	TRUE	This option enables the transparent cut (copy) operation.
UIS\$VT_ENABLE_PASTE	TRUE	This option enables the transparent paste operation.
UIS\$VT_PASTE_FORMAT	0	A value of 0 causes all transparent paste data to be filtered and only passes graphic characters and BELL, TAB, LINE FEED, VERTICAL TAB, FORM FEED and RETURN. A value of 1 passes all data including escape sequences that set graphic rendition and character sets.
UIS\$VT_BUTTON_MAP	0	Assigns the mapping of the M2 and M3 buttons. A value of 0 assigns CUT to M2 (middle button) and PASTE to M3 (right button in right-hand mode). A value of 1 reverses this order, CUT = M3 and PASTE = M2.
UIS\$VT_CURSOR_BLINK	TRUE	In addition to the cursor option available in SETUP, the cursor can be set to nonblinking.
UIS\$VT_ENABLE_LOCATOR	TRUE	This option allows the use of the ANSI Locator extension. This lets terminal applications get button and motion reports on the mouse (or tablet).
UIS\$VT_USER_PREFERENCE_SET	0	The terminal emulator supports both the DEC multinational character set and the ISO Latin-1 character sets. The default (0) uses MCS. A value of 1 uses the ISO Latin-1 set as the supplemental character set.

Additional Features of the VT220 Terminal Emulator

Table B-1 (Cont.) VT220 Emulator Logical Names

Logical Name	Default	Description														
UIS\$VT_FAST_SUSPEND	TRUE	<p>Fast-suspend is a GPX system optimization that can reduce the time it takes for a [CTRL/S] to take effect. When this is enabled, the cursor will not blink during the [CTRL/S].</p> <p>NOTE: There is no benefit to using this on a VAXstation I or VAXstation II, QVSS-based system.</p>														
UIS\$VT_ALTERNATE_ID	0	<p>When the terminal is in VT100 mode, the ID used can be changed by setting the value of the following logical name to:</p> <table style="margin-left: 20px;"> <tr> <td>Logical Value</td> <td>Device ID</td> </tr> <tr> <td>0</td> <td>Native VWS</td> </tr> <tr> <td>1</td> <td>VT100</td> </tr> <tr> <td>2</td> <td>VT101</td> </tr> <tr> <td>3</td> <td>VT102</td> </tr> <tr> <td>4</td> <td>VT125</td> </tr> <tr> <td>5</td> <td>VT200</td> </tr> </table> <p>NOTE: This overrides the native ID in VT200 mode as well.</p>	Logical Value	Device ID	0	Native VWS	1	VT100	2	VT101	3	VT102	4	VT125	5	VT200
Logical Value	Device ID															
0	Native VWS															
1	VT100															
2	VT101															
3	VT102															
4	VT125															
5	VT200															
UIS\$VT_FONT_CHANGE_THRESHOLD	126	<p>The terminal emulator uses two font sizes. The first is the 80-column font and the second the 132-column font. Normally the point where the font changes is 126, which is the number of 80-column characters that would fit using the standard 80 column font. With the availability of other size fonts as well as user demand, the changeover point can be programmed using this logical name.</p>														
UIS\$VT_BUGCHECK_ON_ERROR	FALSE	<p>For debugging purposes, the error handlers can be turned off in the terminal emulator, causing the system to bugcheck on errors like UIS resource exhaustion. Do not use this option unless you are assisting Digital in tracking down an error.</p>														
UIS\$VT_LOCK_MENU_OPTIONS	FALSE	<p>This logical name lets the options be locked. OSC controls cannot change the settings if this is TRUE.</p>														
UIS\$VT_DISABLE_DELETE_OPTION	FALSE	<p>Disables the delete window option.</p>														
UIS\$VT_DISABLE_ADDOPT_OPTION	FALSE	<p>Disables the additional options (SETUP) option.</p>														
UIS\$VT_DISABLE_SHRINK_OPTION	FALSE	<p>Disables the shrink-to-an-icon option.</p>														
UIS\$VT_DISABLE_RESIZE_OPTION	FALSE	<p>Disables the change size option.</p>														

Additional Features of the VT220 Terminal Emulator

Table B-1 (Cont.) VT220 Emulator Logical Names

Logical Name	Default	Description
UIS\$VT_BANNER	"VT200 Terminal"	This logical name sets the default banner. It is normally defined by the UISBG startup. Override this only after UIS has started. If this logical name is deassigned (DEASS/SYS/EXEC) the internal banner will be: "VT200 Terminal - [process_name]" The following logical names are used <i>only at terminal creation</i> and are <i>not</i> used again for that terminal.
UIS\$VT_SPACING_DEF	9	Some logical name usage examples are: <i>UIS\$VT_SPACING_132 7</i> This provides 132 columns with a 7-point spacing, the 132-column default. <i>UIS\$VT_SPACING_080 9</i> This provides 80 columns with a 9-point spacing. These logical names control the default font size and family. If the specified font is not found, the terminal falls back and tries "DVWSVT0" and "DTABER0" families in the specified size. If again no font is found, the size will be set to POINT = 12, SPACING = 7 (132-column default). The spacing is the width of the character in points.
UIS\$VT_POINT_DEF	14	This logical name produces the height of the characters in points. For example: <i>UIS\$VT_POINT_132 12</i> provides 132 columns with a 12 point character height. <i>UIS\$VT_POINT_080 14</i> provides 80 columns with a 14 point character height.
UIS\$VT_PRIVATE_COLOR_MAP	TRUE	This logical name determines if a terminal is a <i>color terminal</i> . A color terminal has a private color map instead of using the system global map. This allows each terminal window to have its own colors. On a monochrome system, this allows the reverse video screen to be used.

Additional Features of the VT220 Terminal Emulator

Table B-1 (Cont.) VT220 Emulator Logical Names

Logical Name	Default	Description
UIS\$VT_PLANE_COUNT	3	This logical name defines how many colors are available on the terminal. The value is selected in terms of the number of <i>planes</i> . The number of planes and the total number of colors for that number of planes available to the system are:

Planes	Colors Available
1	2
2	4
3	8
4	16
5	32
6	64
7	128
8	256

A 0 value defaults to 1. If this logical name is not defined, the default is 3 planes (8 colors).

Select colors for the first 8 color maps by assigning values to a group of logical names. The default colors for the terminal are selected to match the ANSI Color specification for text. The actual RGB (or I) values for the default colors are obtained by using the workstation preferred color values. If more than 8 colors are enabled (plane count > 3) the first 8 colors are replicated for each additional group of 8 colors.

The index values and the colors they produce are:

Index Value	Color
0	Black ¹
1	Blue
2	Red
3	Magenta
4	Green
5	Cyan
6	Yellow
7	White ²

These colors map to the ANSI color selections. The index ordering of colors is selected to allow reverse video mode writing to use an appropriate color, e.g. Blue-Yellow, Red-Cyan, Black-White, Magenta-Green. The ANSI color selections are given in Table Table B-2.

¹Default text background

²Default text foreground

Additional Features of the VT220 Terminal Emulator

Table B-2 ANSI Color Selections

Index	SGR ¹	Color	SGR ¹	Color
0	30	Black text	40	Black text background
2	31	Red text	41	Red text background
4	32	Green text	42	Green text background
6	33	Yellow text	43	Yellow text background
1	34	Blue text	44	Blue text background
3	35	Magenta text	45	Magenta text background
5	36	Cyan text	46	Cyan text background
7	37	White text	47	White text background

¹SGR is the graphic rendition parameter in the SGR control sequence. Example: "<esc>[1;31m" selects BOLD and RED renditions.

Each of the following values in Table B-3 can range from 0 to 1. The decimal fraction should not contain more, but can contain fewer than 6 positions. There are (R)ed (G)reen and (B)lue components as well as the (I)ntensity values.

The full saturation for the color system defaults are shown in Table B-3:

Table B-3 Full Saturation for the Color System Defaults

Red	
Normal Default	Full Saturation
UIS\$VT_R_00	"0.000000"
UIS\$VT_R_01	"0.000000"
UIS\$VT_R_02	"1.000000"
UIS\$VT_R_03	"1.000000"
UIS\$VT_R_04	"0.000000"
UIS\$VT_R_05	"0.000000"
UIS\$VT_R_06	"1.000000"
UIS\$VT_R_07	"1.000000"

Additional Features of the VT220 Terminal Emulator

Table B-3 (Cont.) Full Saturation for the Color System Defaults

Green	
Normal Default	Full Saturation
UIS\$VT_G_00	"0.000000"
UIS\$VT_G_01	"0.000000"
UIS\$VT_G_02	"0.000000"
UIS\$VT_G_03	"0.000000"
UIS\$VT_G_04	"1.000000"
UIS\$VT_G_05	"1.000000"
UIS\$VT_G_06	"1.000000"
UIS\$VT_G_07	"1.000000"

Blue	
Normal Default	Full Saturation
UIS\$VT_B_00	"0.000000"
UIS\$VT_B_01	"1.000000"
UIS\$VT_B_02	"0.000000"
UIS\$VT_B_03	"1.000000"
UIS\$VT_B_04	"0.000000"
UIS\$VT_B_05	"1.000000"
UIS\$VT_B_06	"0.000000"
UIS\$VT_B_07	"1.000000"

Some sample increasing gray level values for an intensity system are shown in Table B-4:

Table B-4 Sample Increasing Gray Level Values for an Intensity System

Gray Levels	Saturation
UIS\$VT_I_00	"0.000000"
UIS\$VT_I_01	"0.145000"
UIS\$VT_I_02	"0.290000"
UIS\$VT_I_03	"0.435000"
UIS\$VT_I_04	"0.580000"
UIS\$VT_I_05	"0.725000"
UIS\$VT_I_06	"0.850000"
UIS\$VT_I_07	"1.000000"

Additional Features of the VT220 Terminal Emulator

Table B-5 shows the FAMILY, SPACING, and POINT defaults:

Table B-5 VT220 Default Font Specifications

Logical Name	Acceptable Value	Default
Default Font File and Size		
UIS\$VT_FAMILY_DEF	7 characters	DTABER0
UIS\$VT_SPACING_DEF	1-n	9
UIS\$VT_POINT_DEF	1-n	14
80-Column Font File and Size		
UIS\$VT_FAMILY_080	7 characters	DTABER0
UIS\$VT_SPACING_080	1-n	9
UIS\$VT_POINT_080	1-n	14
132-Column Font File and Size		
UIS\$VT_FAMILY_132	7 characters	DTABER0
UIS\$VT_SPACING_132	1-n	7
UIS\$VT_POINT_132	1-n	12

B.1.2 Creating and Invoking Escape Sequences

Another way to modify terminal emulator features is by defining escape sequences, which are special character sequences that perform specific actions when invoked. In the 7-bit environment, each sequence begins with the *escape character* located in Row 11, Column 1 of the DEC Multinational Character Set (MCS) table. In the 8-bit environment, these sequences can begin with other special characters.

The simplest way to create and invoke escape sequences is through DCL. Creating an escape sequence in DCL differs depending on whether you are using a 7-bit environment or 8-bit environment. The following examples use the OSC strings to demonstrate both methods.

Seven-Bit Environment

You can generate an escape sequence with a combination of keystrokes. Typing `CTRL/3` generates an escape.

- Create an escape character by loading the correct ASCII value into the first seven bits of a symbol, as follows:

```
$ escape[0,7]==27
```

- Invoke the OSC string by using the escape in conjunction with other characters to construct the OSC and ST special characters. The following example defines a symbol to "push" the terminal window.

```
$ push ::= write sys$output ""''escape']29''esc\''''
```

Additional Features of the VT220 Terminal Emulator

You might want to go one step further and define a key to perform the function, as follows:

```
$ define/key PF2 "push" /nolog/noecho/term
```

Eight_Bit Environment

- Create the necessary special characters by loading the correct ASCII value into the first eight bits of a symbol for each, as follows:

```
$ osc[0,8]==157
$ st[0,8]==156
```

- Invoke the OSC string using DCL. The following example defines a symbol to redefine the terminal window banner.

```
$ banner ::= write sys$output ""''osc'21;New Window Banner''st''''
```

Using TPU to Create Escape Sequences

You can also use the TPU command *copy_text* to insert special characters into a command file when creating escape sequences. Executing the command file executes the included escape sequences. The following example inserts an escape character into a file:

```
copy_text(ascii(27))
```

Three types of special character strings affect the terminal emulator:

- OSC—Operating system command strings
- CSI—Control sequence introducer strings
- DCS—Device control strings

Each is described individually in the following sections.

B.1.3 Operating System Command (OSC) Strings

You can modify a number of terminal emulation features by using OSC strings.

NOTE: To use OSC strings, you must first enable them by defining the logical name `UI$VT_ENABLE_OSC_STRINGS` to be `TRUE`.

The following is the format for Digital private-syntax OSC strings that affect the VT220 terminal emulator:

```
OSC      2      function code ; [parameters] ST
9/13    3/2      9/12 ! column/row (MCS)
```

where:

- OSC = Special initiating character located at column 9, row 13 of the DEC Multinational Character Set (MCS).
- 2 = Decimal value indicating that the sequence is directed to a workstation (column 3, row 2 of the MCS table).
- Function code = Hexadecimal value indicating which terminal emulator feature to modify.

Additional Features of the VT220 Terminal Emulator

The function codes (hexadecimal values) and their meanings are shown in Table B-6.

Table B-6 Function Codes and Their Meanings

Function Code	Meaning
1	Set terminal banner
2	Shrink to icon
3	Expand from icon
4	Move terminal window
5	Move terminal icon
6	Disconnect keyboard
7	Disable keyboard
8	Enable keyboard
9	Push terminal window
A	Pop terminal window
B	Disable menu item
C	Enable menu item
D	Change multi-scroll size
Al	Enable window reports
F	Change font
R	Window report (sent by terminal to host only; ignored by terminal)

Each of these functions and their respective parameters (if any) are described in the following sections.

NOTE: A parameter is any specific value applicable to the specified function. All parameters are separated by a “;”.

The following sections describe which function codes take which parameters. A list of all possible parameters follows.

- **new_banner**—Text for a window banner.
Specify a character string in the range of 0 to 64 bytes.
- **icon_text**—Text for an icon image.
Specify a character string in the range of 0 to 64 bytes.
- **position**—Position for a window or icon.
Specify positive, real, X and Y values that represent the absolute position, in centimeters, from the lower lefthand corner of the display to the lower lefthand corner of the window/icon. Use the following format:

[xx.xxx,yy.yyy]

NOTE: In the above format, leading and trailing square brackets ([]) are required, as is the comma, for separation. A number can be any

Additional Features of the VT220 Terminal Emulator

positive real number. The decimal point is not required for whole numbers, nor are leading or trailing zeros.

The numbers represent the absolute position in centimeters from the bottom left of the display to the bottom left of the window/icon.

If the window (or icon) positions are such that all or part of the window would be off-screen, the window is actually displayed as close as possible to the location, but entirely on-screen.

All parameters must be separated by a semicolon. (The function code is considered a parameter of the OSC string. You must use a semicolon as a placeholder if a parameter is omitted.)

- ST—Special termination character located at Column 9, Row 12 of the DEC Multinational Character Set.

If you are using the VT220 terminal emulator as a 7-bit environment, use two 7-bit characters to represent the special characters. OSC is equivalent to ESC] (escape, right-square-bracket) and ST is equivalent to ESC \ (escape, backslash). See the MCS table for numerical representations.

VTESB—Set Terminal Banner

Changes the text banner of a terminal.

Parameters:

1. FUNCTION CODE 1
2. NEW_BANNER If blank, uses the system default banner.

Text is centered. A null string is ignored. You can specify up to 64 characters; any more than 64 characters are ignored.

Example:

```
<OSC>21;VT220 Terminal <ST>
```

VTESTI—Shrink to Icon

Shrinks a terminal window to an terminal icon.

Parameters:

1. FUNCTION CODE 2
2. POSITION If blank, best fit to BOTTOM-LEFT (if it is the first shrink_to_icon; otherwise, previous icon position.)
3. ICON_TEXT If blank, uses VMS PROCESS NAME.

If the terminal is already an icon, the icon is moved to the position (if specified).

This sequence generates a SHRINK terminal mailbox message if terminal mailbox messages are enabled and the SHRINK was done.

Examples:

```
<OSC>22;[1.5,2];VT220 Terminal Icon<ST>  
<OSC>22;;VT220 Terminal Icon<ST>  
<OSC>22;[1.5,2]<ST>  
<OSC>22<ST>
```

Additional Features of the VT220 Terminal Emulator

VTEEFI—Expand from Icon

Expand a terminal icon to a terminal window.

Parameters:

1. FUNCTION CODE 3
2. POSITION If blank, restores to previous position.
3. NEW_BANNER If blank, does not change banner.

If the terminal is already expanded, the window is moved to the position (if specified) and the banner updated. Text is handled as in set_terminal_banner.

This sequence generates an EXPAND terminal mailbox message if terminal mailbox messages are enabled and the SHRINK is done.

Examples:

```
<OSC>23;[5,7];VT220 Terminal Banner Text<ST>
<OSC>23;;VT220 Terminal Banner Text<ST>
<OSC>23;[5,7]<ST>
<OSC>23<ST>
```

VTEMTW—Move Terminal Window

Move a terminal window.

Parameters:

1. FUNCTION CODE 4
2. POSITION Parameter required, otherwise sequence ignored

If the terminal is in an icon state, the position is used when next expanded to a terminal window.

This sequence generates a MOVED_WINDOW terminal mailbox message if terminal mailbox messages are enabled and the terminal was moved.

Example:

```
<OSC>24;[3.25,6.0]<ST>
```

VTEMTI—Move Terminal Icon

Move a terminal icon.

Parameters:

1. FUNCTION CODE 5
2. POSITION Parameter required, otherwise sequence ignored.

If terminal is not in an icon state, the position is used for the next shrink to icon.

Example:

```
<OSC>25;[5,4]<ST>
```

Additional Features of the VT220 Terminal Emulator

VTEDCONK—Disconnect Keyboard

Disconnect the physical keyboard.

Parameter:

1. FUNCTION CODE 6

The physical keyboard is disconnected from the terminal window. If the terminal is an icon, this sequence is ignored. You can reconnect the keyboard to the terminal by cycling, using **F5**.

This sequence generates a LOST_KB terminal mailbox message if terminal mailbox messages are enabled and the terminal is not an icon.

A UIS\$DISABLE_KB is executed.

VTEDK—Disable Keyboard

Disable the virtual keyboard.

Parameter:

1. FUNCTION CODE 7

The virtual keyboard is disabled. The keyboard can be reconnected to the terminal only with the enable_keyboard sequence.

This sequence generates a LOST_KB terminal mailbox message if terminal mailbox messages are enabled and the terminal is not an icon.

A UIS\$DISABLE_VIEWPORT_KB is executed.

Example:

```
<OSC>27<ST>
```

VTEEK—Enable Keyboard

Connect the keyboard to the terminal.

Parameter:

1. FUNCTION CODE 8

The keyboard is connected to the terminal window.

This sequence generates a GAIN_KB terminal mailbox message if terminal mailbox messages are enabled and the terminal is not an icon.

If the window is an icon, UIS\$ENABLE_VIEWPORT_KB is called; otherwise UIS\$ENABLE_KB is called.

Example:

```
<OSC>28<ST>
```

VTEPUSH—Push Terminal

Push the terminal window.

Parameter:

1. FUNCTION CODE 9

The window (terminal or icon) is *pushed* to the background.

Additional Features of the VT220 Terminal Emulator

Example:

```
<OSC>29<ST>
```

VTEPOP—Pop Terminal

Pop the terminal window.

Parameter:

1. FUNCTION CODE A

The window (terminal or icon) is *popped* to the foreground.

Example:

```
<OSC>2A<ST>
```

VTEDMI—Disable Menu Item

Disable a window options menu item.

Parameters:

1. FUNCTION CODE B

2. item mask 1 = Disable DELETE item
 2 = Disable CHANGE THE SIZE item
 4 = Disable SHRINK TO AN ICON item
 8 = Disable ADDITIONAL OPTIONS item

The item mask can be any value from 0 to 15 formed by combining any of the above values. A value of zero is ignored. The item in the Window Options menu is disabled.

This sequence is ignored if you define the logical `UIS$VT_MENU_OPTIONS_LOCKED` as "TRUE" at the time you create the terminal.

Example:

```
<OSC>2B;10<ST>
```

disables CHANGE THE SIZE and ADDITIONAL OPTIONS.

VTEEMI—Enable a Window Options Menu Item

Parameters:

1. FUNCTION CODE C

2. item mask 1 = Enable DELETE item
 2 = Enable CHANGE THE SIZE item
 4 = Enable SHRINK TO AN ICON item
 8 = Enable ADDITIONAL OPTIONS item

The item mask is any value from 0 to 15 formed by combining any of the above values. A value of zero is ignored. The item in the Window Options menu is enabled.

This sequence is ignored if you define the logical `UIS$VT_MENU_OPTIONS_LOCKED` "TRUE" at the time you create the terminal.

Additional Features of the VT220 Terminal Emulator

Example:

```
<OSC>2C;5<ST>
```

Enables DELETE and SHRINK TO AN ICON.

VTECMS—Change the Size of the Multi-Scroll Feature

Parameters:

1. FUNCTION CODE D
2. size Parameter required, otherwise sequence ignored

The size parameter is a floating point number used to derive the scrolling region size and produce a maximum line count for the multi-scroll optimization.

This number can be any positive value that contains no more than eight digits. Values greater than 1 are valid but not recommended.

Additional Features of the VT220 Terminal Emulator

Example:

```
<OSC>2D;.25<ST>
```

Sets the maximum deferred scroll count to 25 percent of the scrolling region.

VTEEWR—Enable Window Event Reports

Variable Parameters:

- | | |
|------------------|------------------------------------|
| 1. FUNCTION CODE | AI |
| 2. Parameter 2-n | enable parameters |
| | 0—Disable all reports |
| | 1—Enable LOSE KB report |
| | 2—Enable GAIN KB report |
| | 3—Enable SHRINK to ICON report |
| | 4—Enable EXPAND from ICON report |
| | 5—Enable RESIZE WINDOW report |
| | 6—Enable MOVE WINDOW report |
| | 21—Disable LOSE KB report |
| | 22—Disable GAIN KB report |
| | 23—Disable SHRINK to ICON report |
| | 24—Disable EXPAND from ICON report |
| | 25—Disable RESIZE WINDOW report |
| | 26—Disable MOVE WINDOW report |

This sequence enables reports for external windowing events. These reports are also available as VMS terminal mailbox messages.

See `window_event_report` (type = R) for the format of the reports.

Example:

```
<OSC>2E;5;6;23;24<ST>
```

Enables reports for `RESIZE_WINDOW` and `MOVE_WINDOW` and disables `SHRINK` and `EXPAND` icon reports.

VTECTF—Redraw Window with New Font or Size

Parameters:

- | | |
|------------------|--|
| 1. FUNCTION CODE | F |
| 2. point size | If blank, use current point size. If zero, use default point size. This is the height of the font in points. |
| 3. spacing | If blank, use current spacing. If zero, use default spacing. This is the width of the font in points. |
| 4. family name | If blank, uses current font family. Case is significant. The name is padded with the character 0 if less than seven characters long. |

Additional Features of the VT220 Terminal Emulator

This sequence always causes the window to be recreated with the specified font. All graphics in the display are lost, but text is preserved. The sequence is applied to the current font set (that is, is the 80- or 132-column set).

Example:

```
<OSC>2F;19;11;DVWSVT0<ST>
```

Changes the font to a 19-point, 11-pitch font named DVWSVT0

VTEWER—Event Reports

This OSC is sent *from* the terminal *to* the host; it is ignored if transmitted to the terminal.

Format:

```
<OSC>2R; Pt; D...D <ST>
```

Where:

- 2R = Window Event OSC
- Pt = Event type:
 - 1 = KB lose
 - 2 = KB gain
 - 3 = Shrink to icon
 - 4 = Expand from icon
 - 5 = Resize window
 - 6 = Move window
- D...D = Data associated with the report as follows:

- Event type 5 (resize_window)

```
<OSC>2R;5;x_pos,y_pos,width,height<ST>
```

x_pos and *y_pos* are floating point numbers. If the position of the window is offscreen, a -1.0 is returned for the coordinate value.

Width and height are integer values that indicate the size of the terminal in character cells.

- Event type 6 (move_window)

```
<OSC>2R;6;x_pos,y_pos<ST>
```

x_pos and *y_pos* are floating point numbers. If the position of the window is offscreen, a -1.0 is returned for the coordinate value.

All other events return no data.

Examples:

```
<OSC>2R;5;5.2352,1.32,80,24<ST>
```

Resize, new position = [5.2352 , 1.32], size = 80x24

```
<OSC>2R;6;-1.0,5.222<ST>
```

Move, new position = [-1.0 , 5.222] (the x position is offscreen)

```
<OSC>2R;3<ST>
```

Shrink to icon

B.1.4 Control Sequence Introducer Strings

You can set the number of lines and columns on a terminal using Control Sequence Introducer (CSI) strings.

CSI strings are similar to OSC strings except that they begin with the special character CSI (column 9, row 11 of the MCS table). If you are using the VT220 terminal emulator as a 7-bit environment, the special characters can be represented by using two 7-bit characters. CSI is equivalent to ESC [(escape, left bracket). See the MCS table for numerical representations.

DECSLPP—Set Lines Per Page (DEC Private)

This sequence sets the number of display lines per page according to the numeric parameter. It has the format:

```
CSI Pn t
9/11 7/4 ! column/row (MCS)
```

Where:

- CSI = Special initiating character located at column 9, row 11 of the MCS table.
- Pn = Number of display lines per page.

If this number is omitted or zero, the page length defaults to 24.

You can set a maximum of 64 in the current version of the terminal emulator.

- t = Terminating character located at column 7, row 4 of the MCS table.

DECSLPP does not clear page memory, reset the scrolling regions, or move the active position. The scrolling margins can be reset to the extremes of the new page configuration if the current scrolling margin exceeds the physical limits of the new page height. You might lose information if the new page height selected by DECSLPP is too small to hold the previous information.

Examples:

```
<CSI>50t ! Sets the terminal to 50 lines.
<ESC>[20t ! Sets the terminal to 20 lines.
<CSI>t ! Sets the terminal to the default (24 lines).
```

DECSCPP—Set Columns Per Page (DEC Private)

This sequence sets the number of columns on the display page. It has the format:

```
CSI Pn $ |
9/11 2/4 7/12 ! column/row (MCS)
```

Where:

- CSI = Special initiating character located at column 9, row 11 of the MCS table.

Additional Features of the VT220 Terminal Emulator

- Pn = Number of columns on the display page.
If this number is omitted or zero, the page width defaults to 80.
- \$ = Terminating character located at column 2, row 4 of the MCS table.
- | = Terminating character located at column 7, row 12 of the MCS table.

DECSCPP does not clear display memory, reset the scrolling regions, or move the active position. The scrolling margins can be reset to the width of the new page configuration if the current scrolling margin exceeds the width of the new page. You might lose information if the new page width selected by DECSCPP is too small to hold the previous information.

NOTE: You can also change the number of columns per page with Column Mode (DECCOLM). Column Mode is the "old method" of changing page width.

Examples:

```
<CSI>95$|    ! Sets the width to 95 columns
<CSI>$|      ! Sets the width to the default (80 columns).
<ESC>[160$|  ! Sets the width to 168 columns.
```

DECTPM—Transparent Paste Mode (DEC Private)

DECTPM determines whether a particular terminal is able to accept a paste request made by the user. The private selectable mode parameter is:

?76

To set DECTPM, the full Set Mode control function is:

```
CSI  ?    7  6  h
9/11 3/15 3/7 3/6 6/8
```

To reset DECTPM, the full Reset Mode control function is:

```
CSI  ?    7  6  l
9/11 3/15 3/7 3/6 6/12
```

DECTCM—Transparent Copy Mode

DECTCM determines the ability of a terminal to accept copy request.

The private selectable mode parameter is:

?77

To set DECTCM, the full Set Mode control function is:

```
CSI  ?    7  7  h
9/11 3/15 3/7 3/7 6/8
```

To reset DECTCM, the full Reset Mode control function is:

```
CSI  ?    7  7  l
9/11 3/15 3/7 3/7 6/12
```

Additional Features of the VT220 Terminal Emulator

DECSTPF—Select Transparent Paste Format

DECSTPF selects the format the terminal uses to receive pasted information from the Paste Buffer.

The Select Transparent Paste Format (DECSTPF) control function is:

```
CSI  Ps  )  s
9/11 3/? 2/9 7/3
```

Where the value of the selective parameter (Ps) indicates the following:

0 Graphic data only, plus BELL, BS, HT, LF, FF and CR
1 Unfiltered

The “graphic data only” format filters the paste buffer data and allows only graphic characters and selected C0 controls to be transmitted. For example, the format removes SGR and SCS information from the data stream. The unfiltered mode transmits the paste buffer unaltered except for translation of 8-bit to 7-bit controls, based on the setting of C1 transmission mode.

DECTTPB—Transmit Transparent Paste Buffer

DECTTPB transmits the current contents of the paste buffer to the host.

The Transmit Transparent Paste Buffer (DECTTPB) control sequence is:

```
CSI  Ps  )  t
9/11 3/? 2/9 7/4
```

Where the value of the selective parameter (Ps) indicates:

0 Graphic data only, plus BELL, BS, HT, LF, FF and CR
1 Unfiltered

The Graphic data only format filters the paste buffer data and allows only graphic characters and selected C0 controls to be transmitted. For example, this removes SGR and SCS information from the data stream. The unfiltered mode transmits the paste buffer unaltered except for translation of 8-bit to 7-bit controls based on the setting of C1 transmission mode.

DECCTPB—Copy Text to Paste Buffer

The Copy Text to Paste Buffer (DECCTPB) device control string is:

```
DCS  !  x  D...D  ST
9/11 2/1 7/8  ?/?...?/? 9/12
```

The data of the DECCTPB string consists of hex pairs to be inserted into the paste buffer. There is an implementation-dependent maximum paste buffer size. Data outside this size is ignored.

B.1.5 ANSI Color Text SGRs

SGR—Select Graphic Rendition (Format Effector)

SGR is a format effector that specifies one or more graphic rendition aspects for the characters following in the data stream.

The format for SGR is:

```
CSI  Ps  m
9/11 3/? 6/13
```

The specified graphic rendition aspects remain in effect either until the next occurrence of SGR, or until they are explicitly changed by a following occurrence of SGR. Each graphic rendition aspect is specified by a parameter value (Ps).

Table B-7 shows the parameter values and the aspects they change.

Table B-7 Parameter Values and the Aspects They Change

Parameter Value	Aspect Changed
Ps	
0	Default rendition (all attributes OFF, or at default state). Cancels the effect of any preceding SGR.
1	Bold or increased intensity.
4	Underlined
5	Slowly blinking (.5 hz)
7	Negative image (reverse video)
8	Concealed characters
22	Not bold
24	Not underlined
25	Steady (not blinking)
27	Positive image
28	Revealed characters
Text	
30	Black text
31	Red text
32	Green text
33	Yellow text
34	Blue text
35	Magenta text
36	Cyan text
37	White text
39	Default text (White)
Background	
40	Black text background

Additional Features of the VT220 Terminal Emulator

Table B-7 (Cont.) Parameter Values and the Aspects They Change

Parameter Value	Aspect Changed
41	Red text background
42	Green text background
43	Yellow text background
44	Blue text background
45	Magenta text background
46	Cyan text background
47	White text background
49	Default text background color (Black)

Text color specification is ignored unless the terminal is created with `UIS$VT_PRIVATE_COLOR_MAP TRUE` and at least 8 colors are available. The presence of ANSI Color Text is shown in the Primary Device Attribute report as a value of 22. Table B-8 shows the color map index and the corresponding ANSI color:

Table B-8 Color Map Index and Corresponding Color

Color Map Index	ANSI Color
Index 0	Black
Index 1	Blue
Index 2	Red
Index 3	Magenta
Index 4	Green
Index 5	Cyan
Index 6	Yellow
Index 7	White

B.1.6 Device Control Sequences

You can query the terminal window for the length and width of its page using `DECRQSS`. The terminal emulator responds using `DECRPSS`. You can inquire about `DECSCPP` and `DECSLPP`.

DCS strings are similar to OSC strings except that they begin with the special character Device Control Sequence DCS (column 9, row 0 of the MCS table). If you are using the VT220 terminal emulator as a 7-bit environment, the special characters can be represented using two 7-bit characters. DCS is equivalent to `ESC P` and ST is equivalent to `ESC \` (escape, backslash). See the MCS table for numerical representations.

Additional Features of the VT220 Terminal Emulator

DECRQSS—Request Selection or Setting (DEC Private)

Request Selection or Setting is sent to Terminal to determine the setting of page width or page length. It has the format:

```
DCS $ q D...D ST
9/0 2/4 7/1 9/12 ! column/row (MCS)
```

Where:

- DCS = Special initiating character located at column 9, row 0 of the MCS table.
- \$ = Required intermediate character located at column 2, row 4 of the MCS table.
- q = Required intermediate character located at column 7, row 1 of the MCS table indicating number of display lines per page.
- D...D = Terminating characters of the control string that set the feature. Must be one of the following:
 - \$ |—Set columns per page (DECSCPP)
 - t—Set lines per page (DECSLPP)
- ST = Terminating character located at column 9, row 12 of the MCS table.

NOTE: You can use DECRQSS to query only one setting at a time.

Examples:

```
<DCS>$q$|<ST> ! Requests the number of columns per page.
```

```
<DCS>$qt<ST> ! Requests the number of lines per page.
```

DECRPSS—Report Selection or Setting (DEC Private—Terminal to Host)

The terminal emulator issues the report selection or setting device control string in response to a request selection or setting command. When possible, the terminal emulator returns the setting of the page width or page length. This control string has the following format:

```
DCS Ps $ r D...D ST
9/0 2/4 7/2 9/12 ! column/row (MCS)
```

Where:

- DCS = Special initiating character located at column 9, row 0 of the MCS table.
- Ps = Request success indicator, where:
 - 0 = Request successful, data contains selection information.
 - 1 = Request unsuccessful, unknown selection or setting.
- \$ = Required intermediate character located at column 2, row 4 of the MCS table.
- r = Required intermediate character located at column 7, row 2 of the MCS table indicating number of display lines per page.
- D...D = Data returned by the DECRPSS control string.

Additional Features of the VT220 Terminal Emulator

This is the entire control string that would be sent to the terminal emulator to set the page length or width to arrive at the current setting. The leading control sequence introducer character (CSI, or ESC [in 7 bits) is omitted.

The returned control contains no omitted parameters, even if the inquired value is the default value.

- ST = Terminating character located at column 9, row 12 of the MCS table.

NOTE: The DECRPSS control string that indicates UNKNOWN is always coded as follows:

```
DCS 1 $ r ST
```

Examples:

In response to a <DCS>\$qt<ST> command with the current number of lines at 50, the response would be:

```
<DCS>0$r50t<ST>
```

In response to a <DCS>\$q\$|<ST> command with the current number of columns at 132, the response would be:

```
<DCS>0$r132$|<ST>
```

B.1.7 Locator Input for VWS Terminals

B.1.7.1 ANSI Locator (mouse/tablet) Input

The workstation is supplied with a locator port that can be used to connect a mouse or tablet. When locator reporting is enabled, the cursor changes shape and the terminal tracks the locator locally with no host intervention. Individual locator events such as locator button transitions or movement can be programmed to send locator reports to the host.

Each locator report includes the following information:

- The specific event that initiated the report
- The current state of the locator keys
- The coordinates of the input cursor at the time of the event

The locator is treated as a manual input device similar to a keyboard. Locator events are queued with keystrokes in the typeahead buffer.

B.1.7.2 Locator Input Model

B.1.7.2.1 Enabling Locator Reporting

To enable locator reporting selectively from the host, use a Digital private control sequence. When it is not in locator input mode, the cursor remains the system default shape (arrow). When it is in locator input mode, the cursor changes shape to that specified in the DECSLCS control sequence. (The default shape in this case is a small crosshair.) Individual locator

Additional Features of the VT220 Terminal Emulator

events such as locator button transitions or movement can be programmed to send locator reports to the host.

B.1.7.2.2 DECELR—Digital Enable Locator Reports

```
CSI Ps ; Pu ' z
                2/7 7/10
```

Ps can assume the following values:

- 0—locator disabled (default)
- 1—locator reports enabled
- 2—one shot (allow one report, then disable)

Pu specifies the coordinate units for locator reports.

- 0—(or omitted) default to character cells
- 1—device physical pixels
- 2—character cells

One-shot mode is provided for applications that desire simple graphics input similar to Tektronix GIN mode (no unsolicited reports). If parameter value 2 is selected, the next trigger event that occurs generates a single locator report. No further locator reports occur (the locator is disabled), until another DECELR sequence is received.

The coordinate units for locator position reports can be selected to any of the three coordinate systems used by terminal software at the lowest level. Physical pixels is the "least common denominator" and is useful for computing sixel positions.

B.1.7.2.3 Locator Position Reporting

When a selected trigger event such as a button press or release occurs, the terminal transmits a locator position report as follows:

```
DECLRP - DEC Locator Report
CSI Pe ; Pb ; Pr ; Pc ; Pp & w
                2/6 7/7
```

- Pe—event code
- Pb—button code
- Pr—row coordinate
- Pc—column coordinate
- Pp—third coordinate (page number)

The event code Pe indicates what event caused this report to be generated. The following event codes are defined:

- 0 - request, the terminal received an explicit request for a locator report, but the locator is unavailable
- 1 - request, the terminal received an explicit request for a locator report
- 2 - left button down
- 3 - left button up

Additional Features of the VT220 Terminal Emulator

- 4 - middle button down
- 5 - middle button up
- 6 - right button down
- 7 - right button up
- 8 - fourth button down
- 9 - fourth button up
- 10 - locator outside filter rectangle

The button code *Pb* is an ASCII decimal value from 0 through 15 that indicates which buttons if any are down. The state of the four buttons on the locator corresponds to the four low order bits of the decimal value; "1" indicates button depressed.

- 0 - no buttons down
- 1 - right
- 2 - middle
- 4 - left
- 8 - fourth

The row coordinate *Pr* of the locator position in the page is encoded as an ASCII decimal value.

The column coordinate *Pc* of the locator position in the page is encoded as an ASCII decimal value.

The page coordinate *Pp* of the locator position is encoded as an ASCII decimal value. You can omit the page coordinate (*Pp* is included for future compatibility with VT300 series terminals).

Each locator report includes the following information:

- The specific transition that caused this event
- Current button state

This allows software to determine what event just occurred and which buttons are down, without keeping track of previous events or button state.

Locator events (like keystrokes) are queued in the keyboard input silo. The data is inserted into the VMS typeahead buffer. By default, this buffer can handle 70 characters ahead. VMS handles overflow of the typeahead buffer as normal keyboard overflow.

B.1.7.2.4 Filter Rectangles

Filter Rectangles add filtered movement events to the list of locator transitions that can generate reports.

DECEFR - DEC Enable Filter Rectangle

CSI Pt ; Pl ; Pb ; Pr ' w
2/7 7/7

Pt—top boundary of filter rectangle
Pl—left boundary of filter rectangle
Pb—bottom boundary of filter rectangle

Additional Features of the VT220 Terminal Emulator

Pr—right boundary of filter rectangle

The DECEFR control sequence defines the coordinates of a filter rectangle and activates the filter rectangle. When the locator is found to be outside a filter rectangle, an outside rectangle event is generated and the rectangle is disabled. Filter rectangles are always treated as "one-shot" events. Defining a new rectangle re-activates it.

Applications can redefine the rectangle at any time even if it is already active. If you specify a rectangle that does not contain the locator, the terminal generates an outside rectangle report immediately and deactivates it.

Pt, Pl, Pb, and Pr are in coordinate units specified by the last DECELR sequence. The filter rectangle includes the boundaries (similar to other rectangular area operations). The origin is coordinate pair 1:1 in the upper left corner. If any parameters are omitted, they default to the current locator position. Sending DECEFR with no parameters causes the application to be notified for any locator movement ("unfiltered movement event").

DECELR always cancels any previous filter rectangle definition. This guarantees that when an application enables locator reports, there is never an outstanding filter rectangle.

B.1.7.2.5 Selecting Locator Events

To select individually the locator events that can generate unsolicited reports, use the Select Locator Events control. The locator can report both up and down transitions for those situations where the exact sequence of button activations is significant. This control allows application software to select which events it wants reported.

```
DECSLE - Select Locator Events
CSI P...P ' {
          2/7 7/11
```

P...P is one or more selective parameters that can assume the following values:

- 0—respond only to explicit host requests (default; also cancels any pending filter rectangle)
- 1—report button down transitions
- 2—do not report button down transitions
- 3—report button up transitions
- 4—do not report button up transitions

B.1.7.2.6 Requesting a Locator Position Report

The host can explicitly request a locator position report any time locator reporting is enabled (DECELR). When it receives such a request, the terminal immediately sends a single locator report (DECLRP) with event code 1 indicating the last locator position. If the session receiving the request is not currently active (the locator is being used in another session), the last known locator position and state for this session is used. If the locator is disabled or unavailable, the report specifies event code 0.

Additional Features of the VT220 Terminal Emulator

DECRQLP - DEC Request Locator Position

```
CSI Ps ' |  
      2/7 7/12
```

Ps:

- 0—(or omitted) default to 1
- 1—transmit a single DECLRP locator report
- All others—ignored

DECSLCS - Select Locator Cursor Style

```
CSI Ps ) u  
9/11 3/? 2/9 7/5
```

Ps:

- 0—(or omitted) crosshair
- 1—"box corner" style

DECSLCS selects the style of cursor that displays when locator input is enabled in ANSI mode.

B.1.7.3 Locator Device Support

Locator support is an extension to the level 2 and level 3 character cell architecture. The primary device attributes response reports the locator extension as parameter value 29.

Note: Do not confuse this with the VT300 ReGIS locator extension (parameter 15).

Host software can request a Device Status Report (DSR) to determine whether a locator is available. When it receives the appropriate DSR request, the terminal responds: it indicates the locator is ready if a locator device is plugged in and has transmitted a successful self test message.

Table B-9 Locator Device Status Report (DSR)

Host request locator device status	CSI ? 55 n
No locator	CSI ? 53 n
Locator ready	CSI ? 50 n
Locator busy	CSI ? 58 n

The locator busy response can occur when an alternate session has selected locator controller mode.

B.1.8 VWS VT200 Terminal Emulation Copy and Paste

The following specifies the Copy and Paste functions that are implemented for VWS terminal emulation for Version 3.3 and later.

B.1.8.1

Description:

Copy & Paste provides a mechanism to transfer text between terminal windows. It is *not* a general UIS facility and text cannot be moved between non-terminal windows.

NOTE: This should be temporary. Future releases of UIS should supply a clipboard facility. The VT200 emulator can take advantage of this.

A 16k byte global buffer is used as the terminal "clipboard" and is interlocked to prevent concurrent updating.

Two modes of operation are possible—Programmed and Transparent.

- Transparent mode provides application transparent (non-cooperating) copy and paste facilities between terminal windows. You use the locator (mouse or tablet) to select an area of text. The selected text is copied to the global buffer and can be transmitted to the host as keyboard data. Transparent mode is not available when the terminal is in ANSI locator report mode (LRP) or when the terminal is in ReGIS mode.
- Programmed mode provides a set of escape sequences to load and transmit the Paste Buffer under program control. Combined with the ANSI locator sequences, applications can do their own Cut/Copy and Paste operations using the systemwide Paste Buffer.

B.1.8.1.1

Human Interface (Transparent Mode)

The Select and Paste functions are assigned to the M2 and M3 locator buttons. By default, Select is bound to M2 and Paste to M3. This assignment can be reversed by a logical name assignment that is evaluated during terminal reset. M1 always cancels a Select operation in progress.

Transparent mode operations can be selectively enabled and disabled for each terminal window. The default can be established by the assignment of a logical name that is evaluated during a terminal reset. It can also be changed by the use of an escape sequence under program control. Copy and Paste functions are independent and can be individually enabled/disabled.

B.1.8.1.2

Button Operation

Pressing any button causes the terminal window to be popped if it is occluded and the KB to be assigned if enabled and not attached.

M1 (Left ¹)	Cancel selection
M2 (Center)	Select (copy)
M3 (Right ¹)	Paste

¹Right-hand SETUP

Additional Features of the VT220 Terminal Emulator

B.1.8.1.3 Copy Operations

Begin a Copy operation by clicking the Select button. This highlights the beginning of the selection of the text to be copied according to the selection style:

- **Rectangular**—The indicated character cell position has a complement mode outline drawn around it. This character cell becomes one corner of the select area. Moving the locator causes the outline shape to “rubberband,” with the locator position as the opposite corner of a rectangular area to be selected.
 - Clicking the M1 button cancels the operation.
 - Clicking the Select button a second time causes all text within the rectangular area to be copied to the Paste Buffer.
- **Stream (editor-style)**—This resembles text selection in an editor. The character cell position pointed to is “highlighted” (by default reverse video). Moving the mouse causes the text between the first selection point and the current position to be highlighted. You can alter the highlight attributes to allow for color as well as reverse video, bold, and underline as alternate mechanisms for highlighting the selected text.

To complete the copy, press the Select or Paste button. This causes the text within the selected area, including control sequences to select character sets and graphic rendition, to be copied into the paste buffer. All lines except the last have a <CR> appended. Unwritten character positions at the end of each line can be trimmed.

In Stream mode, the selected text is redrawn in its normal rendition. In Rectangular mode, the rubberband box is erased. The Cancel button also unhighlights the selected text and does not copy the data into the paste buffer, but cancels the copy operation.

The transparent copy operation causes the text within the selected area, including control sequences to select character sets and graphic rendition, to be copied into the paste buffer. All lines except the last have a <CR> appended. Unwritten character positions at the end of each line can be trimmed. The text is always prefixed by sequences that set the correct default settings. These sequences can be removed from the pasted data later.

NOTE: The VT220 terminal emulator can distinguish between character cells that are normal rendition spaces and cells that have not had data written to them. Unwritten character cells that precede the last graphic data on the line are converted to spaces.

B.1.8.1.4 Paste Operations

To initiate a Paste operation, click the Paste button when pointing to a terminal window. The data in the Paste buffer is transmitted to the terminal as keyboard data.

The Paste operation transfers the contents of the Paste buffer to the terminal input buffer. During this operation, the Paste buffer is locked and cannot be accessed by another Copy or Paste operation. The buffer can be filtered to allow only the graphic character data and BELL, BS,

Additional Features of the VT220 Terminal Emulator

HT, LF, FF and CR controls. This removes escape, control, device and operating sequences.

If flow control (HOSTSYNCH) is enabled for the terminal, a Paste Buffer larger than the terminal typeahead buffer can be transmitted. If flow control is not enabled, Paste operations can cause data overruns.

B.1.8.2 Programmed Mode

No human interface is imposed on an application that directly accesses the Copy & Paste facilities. Instead, sequences have been provided to allow terminal applications to implement their own human interface. This allows applications to provide a "native" application-specific selection mechanism. Sequences provide for copying to and dumping from the Paste Buffer.

The Copy to Paste Buffer, Transmit Paste Buffer, and Begin Selection sequences in combination with the ANSI locator input model allow for a flexible programming interface to Copy and Paste.

B.1.8.2.1 Copy Operations

A device control sequence is provided to allow arbitrary data to be written into the Paste Buffer under program control. The data is encoded as hex pairs and allows any value to be written.

B.1.8.2.2 Paste Operations

A control sequence causes the contents of the Paste Buffer to be transmitted to the host. An optional parameter causes this data to be transmitted as encoded hex pairs within a DCS string.

Table B-10 Logical Names for SETUP

UIS\$VT_ENABLE_COPY	Enables transparent Copy Default "FALSE"
UIS\$VT_ENABLE_PASTE	Enables transparent Paste Default 0
UIS\$VT_PASTE_FORMAT	Format for transparent mode Paste 0 = Graphic characters plus BELL, BS, HT, LF, FF, and CR (default) 1 = All data (unfiltered)
UIS\$VT_BUTTON_MAP	Locator button assignment 0 = M2:Copy, M3:Paste (default) 1 = M3:Copy, M2:Paste
UIS\$VT_HIGHLIGHT_MASK	Selects the graphic rendition for text Highlighting in "stream" type selects. The format of this mask is to be TBD. Default REVERSE video
UIS\$VT_STREAM_SELECT	Enables "stream" style text selection

Additional Features of the VT220 Terminal Emulator

Table B-10 (Cont.) Logical Names for SETUP

	for transparent mode Copy operations. If this is FALSE, rectangular style selection is done. Default "TRUE"
UIS\$VT_SELECT_TRIM	Enables trimming of trailing unwritten character positions. If FALSE, trailing unwritten cells are converted to the space character. Default "TRUE"

B.1.8.3 Terminal Sequences

Private selectable mode (SM/RM) parameter: DECTPM

Transparent Paste Mode (DECTPM) has the following private selectable mode parameter:

?76

To set DECTPM, the full Set Mode control function would be:

```
CSI  ?    7    6    h
9/11 3/15 3/7 3/6 6/8
```

To reset DECTPM, the full Reset Mode control function would be:

```
CSI  ?    7    6    l
9/11 3/15 3/7 3/6 6/12
```

DECTPM determines whether a particular terminal can accept a paste request made by the user.

Private selectable mode (SM/RM) parameter: DECTCM

Transparent Copy Mode (DECTCM) has the following private selectable mode parameter:

?77

To set DECTCM, the full Set Mode control function would be:

```
CSI  ?    7    7    h
9/11 3/15 3/7 3/7 6/8
```

To reset DECTCM, the full Reset Mode control function would be:

```
CSI  ?    7    7    l
9/11 3/15 3/7 3/7 6/12
```

DECTCM determines whether a particular terminal can accept a copy request made by the user.

Select Transparent Paste Format (DECSTPF) control sequence

The Select Transparent Paste Format (DECSTPF) control sequence is registered as:

```
CSI  Ps  )    s
9/11 3/? 2/9 7/3
```

Additional Features of the VT220 Terminal Emulator

where the value of the selective parameter (Ps) indicates:

- 0—Graphic data only, plus BELL, BS, HT, LF, FF and CR
- 1—Unfiltered

DECSTPF selects the format in which the terminal receives pasted information from the Paste Buffer. The Graphic data-only format filters the Paste Buffer data and allows only graphic characters and selected C0 controls to be transmitted. This removes, for example, SGR and SCS information from the data stream. The unfiltered mode transmits the Paste Buffer unaltered except for translation of 8-bit controls to 7-bit based on the setting of C1 transmission mode.

Transmit Transparent Paste Buffer (DECTTPB) control sequence

The Transmit Transparent Paste Buffer (DECTTPB) control sequence is registered as:

```
CSI Ps; Pf ) t
9/11 3/? 3/? 2/9 7/4
```

where the value of the selective parameter (Ps) indicates:

- 0—Graphic data only, plus BELL, BS, HT, LF, FF, and CR
- 1—Unfiltered

and the value of the format parameter (Pf) indicates:

- 0—Transmit ASCII data
- 1—Transmit as DECCTPB DCS encoded string

DECTTPB causes the current contents of the paste buffer to be transmitted to the host. The Graphic data-only format filters the Paste Buffer data and allows only graphic characters and selected C0 controls to be transmitted. This removes, for example, SGR and SCS information from the data stream. The unfiltered mode transmits the Paste Buffer unaltered except for translation of 8-bit controls to 7-bit based on the setting of C1 transmission mode.

If the optional parameter Pf is 0 or omitted, the data is transmitted to the host as ASCII data with no indication of the beginning or end of the data. If Pf is 1, the Paste data is transmitted as hexadecimal pairs and is included in a DECCTPB DCS/ST envelope:

```
DCS Pc ! x D...D ST
9/11 2/1 7/8 ?/?...?? 9/12
```

The data of the DECCTPB string consists of hex pairs that represent the contents of the Paste Buffer. The parameter Pc indicates the byte count of the following D...D data.

Copy Text to Paste Buffer (DECCTPB) control string

The Copy Text to Paste Buffer (DECCTPB) device control string is registered as:

```
DCS ! x D...D ST
9/11 2/1 7/8 ?/?...?? 9/12
```

Additional Features of the VT220 Terminal Emulator

The data of the DECCTPB string consists of hex pairs to be inserted into the Paste Buffer. There is an implementation-dependent, maximum paste buffer size. Data greater than this size is ignored.

B.2 ReGIS Implementation

VWS V4.1 implementation of ReGIS is based on VT241 ReGIS. It has the following restrictions:

- Line patterns could be wrong (pattern not right).
This happens because there is a problem in the way patterned lines are drawn in UIS.
- Pattern multiplication is limited to 32 bits.
This is a limit in the way UIS creates line patterns.
- Text is not clipped to display cell size.
Text is displayed at the full unit cell size and is not clipped. This is true because there is little support for this in UIS. (It is unlikely that this limitation will ever be removed.)
- Unit cell characters smaller than the display cell are not replicated in the display cell.

Only one copy of the character is inside the display cell. (It is unlikely that this limitation will ever be removed.)

ReGIS works on any size window with any font. However, it approximates a VT241 only when the terminal uses the 19-point, 11-pitch font at a terminal size of 80x24 or when the terminal uses the 19-point, 7-pitch font at a terminal size of 133x24 (133-columns to get 798 pixels).

ReGIS maps the window by taking the S(A) screen coordinates (800x480 by default) and mapping this rectangle into as large a portion of the screen as possible (flush with the UPPER LEFT of the window), keeping a 1:1 aspect ratio. It tries to preserve the 800x480 shape that most ReGIS applications depend on.

B.3 VWS Terminal Mailbox Messages

Terminal mailbox messages are important to applications that keep track of events on particular terminal windows. For messages to be delivered, the following must be true:

- A terminal must have an associated mailbox.
- You must define the logical name `UIS$VT_ENABLE_MBX_EVENTS` as TRUE. (The default value is FALSE.)

Additional Features of the VT220 Terminal Emulator

Table B-11 lists each event that causes a message to be written, as well as the message name and value:

Table B-11 Message Events, Names, and Values

Event	Name	Value
Keyboard disables	(105)	MSG\$TRMLOSE_KB
Keyboard enabled	(106)	MSG\$TRMGAIN_KB
Window shrunk to icon	(107)	MSG\$TRMSHRINK
Icon expanded to window	(108)	MSG\$TRMEXPAND
Window resized	(109)	MSG\$TRMRESIZE
Window moved	(110)	MSG\$TRMMOVE

Figure B-1 illustrates the standard Terminal Mailbox Message format:

Figure B-1 Standard Mailbox Message Format

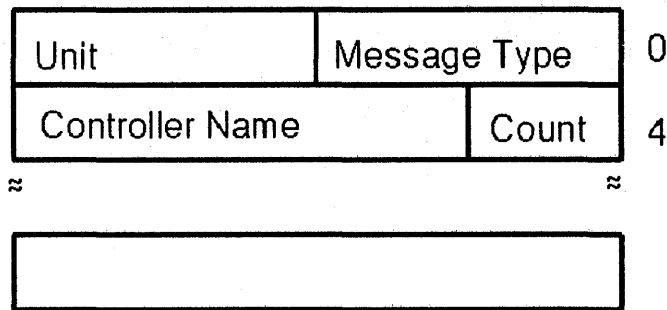

Of the five events that can occur, only two, RESIZE and MOVE, return any data. Each is described below.

RESIZE message format

A resize event returns:

- New origin as F_FLOATING data, in centimeters (as returned by UIS\$GET_VIEWPORT_POSITION).
- New size as INTEGER data, in columns and rows.

Figure B-2 illustrates the resize message format:

Additional Features of the VT220 Terminal Emulator

Figure B-2 Format for RESIZE Message

Unit	Message Type	0
Controller Name	Count	4
≈	≈	
New_X (left)		20
New_Y (bottom)		24
New_Width		28
New_Height		32

MOVE message format

A move event returns:

- New origin as F_FLOATING data, in centimeters (as returned by UIS\$GET_VIEWPORT_POSITION).

Figure B-3 illustrates the move message format:

Figure B-3 Format for MOVE Message

Unit	Message Type	0
Controller Name	Count	4
≈	≈	
New_X (left)		20
New_Y (bottom)		24

C

Compose Sequences

This appendix provides reference material for using compose sequences in VT220 terminal emulation. This material includes the following topics:

- Instructions for composing special characters
- Table of valid compose sequences in national mode
- Table of valid compose sequences in multinational mode

C.1 Composing Characters

You can use *compose sequences* to create characters that do not exist as standard keys on your keyboard. To use a compose sequence, you press a series of keys.

You can use two types of compose sequences: *three stroke* and *two stroke*. The compose sequences you use depends on the character set mode selected: national or multinational. In national mode, the compose sequences you can use depend on the keyboard selected.

C.1.1 Three-Stroke Compose Sequences

You can use three-stroke sequences on all VT220 keyboards. Table C-2 lists three-stroke sequences for national character set mode. Table C-3 lists three-stroke sequences for multinational character set mode.

A three-stroke compose sequence involves three actions: First, you press the Compose Character (or Symbol) key. Then you press two standard keys whose characters form a valid compose sequence.

To create a three-stroke compose sequence, do the as following:

- 1 Find the character you want to create in Column 1 of Table C-2 or Table C-3.
- 2 Press the Compose Character key. (The Compose indicator comes on, indicating the terminal is in compose mode.)
- 3 Type the two characters in Column 2 for the character you want to create.

For example, to create *e* with an acute accent, press Compose Character. Next, type *e* and an apostrophe or press Compose Character. Then type an apostrophe and *e*.

When you complete a valid sequence, the screen displays the composite character and the Compose indicator turns off. If you use an invalid sequence, the sequence is aborted and the bell sounds (if the warning bell is enabled in the setup menu).

NOTE: Function keys abort a compose sequence without sounding the bell.

C.1.2 Two-Stroke Sequences

You can use two-stroke sequences on all keyboards except the North American keyboard. Table C-2 lists two-stroke sequences for national character set mode. Table C-3 lists two-stroke sequences for multinational character set mode.

Two-stroke sequences are faster than three-stroke sequences, but are limited to sequences starting with diacritical marks. Two-stroke sequences also do not use the Compose Character key. Instead, you enter a nonspacing diacritical mark first. You then enter a standard character that forms a valid compose sequence with the diacritical mark. The nonspacing diacritical marks you can use are the following:

- Grave accent
- Acute accent
- Circumflex accent
- Tilde mark
- Diaeresis mark (umlaut)
- Ring mark

(Some keyboards have keys that contain both a standard character and a diacritical mark. When you do compose sequences with these keys, the Shift and Lock keys work as usual).

Diacritical marks vary depending on the LK201 variation. Rather than diacritical marks, the North American keyboard has equivalent characters. Table C-1 shows the diacritical marks and their equivalent characters on the North American keyboard:

Table C-1 Diacritical Marks and Their Equivalent Characters

Diacritical Mark	Equivalent Character
Grave accent	Single quote '
Acute accent	Apostrophe '
Circumflex accent	Circumflex character
Tilde mark	Tilde character
Diaeresis (umlaut) mark	Double quote "
Ring mark	Asterisk * or degree o

To create a two-stroke compose sequence, do the following:

- 1 Find the character you want to create in Column 1 of Table C-3 or Table C-2. Verify in Column 3 that the character can be created.
- 2 Press the key with the diacritical mark shown in Column 3. (The Compose indicator comes on, indicating the terminal is in compose mode.)
- 3 Type the second character shown in Column 3.

For example, to create *e* with an accent grave on a Danish keyboard, press the key that has the grave accent and then type *e*.

When you complete a valid sequence, the screen displays the composite character and the Compose indicator turns off. If you use an invalid sequence, the sequence is aborted and the bell sounds (if the warning bell is enabled in the setup menu).

NOTE: Function keys abort a compose sequence without sounding the bell.

C.1.3 Aborting or Restarting a Compose Sequence

If you accidentally enter compose mode (by pressing the Compose Character key or a diacritical mark key), press the DELETE key (**<X>**) to immediately terminate the compose sequence and exit compose mode. The terminal does not display a composite character.

If you press Compose Character during a compose sequence, a new three-stroke sequence starts from that point. The previous sequence cannot be displayed.

C.2 Compose Sequence Tables

Table C-2 lists the two-stroke and three-stroke compose sequences for national mode.

In three-stroke sequences, you can enter required characters in any order unless the table states "order sensitive." You must enter all two-stroke sequences in the order shown.

When you see (sp), press the space bar.

Table C-2 Compose Sequences for National Character Set Mode

Composite Character	Meaning	Three-Stroke Sequence	Two-Stroke Sequence
"	quotation mark	" (sp)	.. (sp)
#	number sign	+ +	
'	apostrophe	' (sp)	' (sp)
@	commercial at	a a or A A	
[opening bracket	((
\	backslash	// or / <	
]	closing bracket))	
^	circumflex accent	(sp)	(sp)
'	single quote	' (sp)	' (sp)
{	opening brace	(-	
	vertical line	/	
}	closing brace)-	
~	tilde	(sp)	(sp)
¡	inverted !	!!	
¢	cent sign	c/ or C/ or c or C	

Compose Sequences

Table C-2 (Cont.) Compose Sequences for National Character Set Mode

Composite Character	Meaning	Three-Stroke Sequence	Two-Stroke Sequence
£	pound sign	l- or L- or l= or L=	
¥	yen sign	y- or Y- or y= or Y=	
§	section sign	so or SO or Sl or s! or s0 or S0	
¤	currency sign	xo or XO or x0 or X0	
©	copyright sign	co or CO or c0 or C0	
ª	feminine ordinal indicator	a- or A-	
«	angle quotation mark left	< <	
°	degree sign	0 [°] or (sp)#	
±	plus/minus sign	+ -	
²	superscript 2	2 [^]	
³	superscript 3	3 [^]	
µ	micro sign	l / or lU order sensitive	
¶	paragraph sign	pl or Pl	
·	middle dot	.	
¹	superscript 1	1 [^]	
º	masculine ordinal indicator	o_ or O_	
»	angle quotation mark right	> >	
¼	fraction one-quarter	1 4 order sensitive	
½	fraction one-half	1 2 order sensitive	
¿	inverted ?	??	
À	A grave	A'	'A
Á	A acute	A'	'A
Â	A circumflex	A [^]	^A
Ã	A tilde	A [~]	~A
Ä	A umlaut	A [¨]	¨A
Å	A ring	A* or A [°] degree sign	'A

Table C-2 (Cont.) Compose Sequences for National Character Set Mode

Composite Character	Meaning	Three-Stroke Sequence	Two-Stroke Sequence
Æ	A E ligature	AE order sensitive	
Ç	C cedilla	C,	
È	E grave	E'	'E
É	E acute	E'	'E
Ê	E circumflex	E^	^E
Ë	E umlaut	"E or E"	E"
Ì	I grave	I'	'I
Í	I acute	I'	'I
Î	I circumflex	I^	^I
Ï	I umlaut	I"	I"
Ñ	N tilde	N~	~N
Ò	O grave	O'	'O
Ó	O acute	O'	'O
Ô	O circumflex	O^	^O
Õ	O tilde	O~	~O
Ö	O umlaut	O"	"O
Œ	O E ligature	O E order sensitive	
Ø	O slash	O/	
Ù	U grave	U'	'U
Ú	U acute	U'	'U
Û	U circumflex	U^	^U
Ü	U umlaut	U"	U"
ÿ	Y umlaut	Y"	Y"
ß	German small sharp s	ss	
à	a grave	a'	'a
á	a acute	a'	'a
â	a circumflex	a^	^a
ã	a tilde	a~	~a
ä	a umlaut	a"	a"
å	a ring	a* or ao degree sign	oa
æ	a e ligature	a e order sensitive	
ç	c cedilla	c , (comma)	
è	e grave	e'	'e
é	e acute	e'	'e

Compose Sequences

Table C-2 (Cont.) Compose Sequences for National Character Set Mode

Composite Character	Meaning	Three-Stroke Sequence	Two-Stroke Sequence
ê	e circumflex	e^	^e
ë	e umlaut	e"	e"
ì	i grave	i'	'i
í	i acute	i'	'i
î	i circumflex	i^	^i
ï	i umlaut	i"	"i
ñ	n tilde	n~	~n
ò	o grave	o'	'o
ó	o acute	o'	'o
ô	o circumflex	o^	^o
õ	o tilde	o~	~o
ö	o umlaut	o"	o"
œ	o e ligature	o e order sensitive	
ø	o slash	o/	
ù	u grave	u'	'u
ú	u acute	u'	'u
û	u circumflex	u^	^u
ü	u umlaut	u"	u"
ÿ	y umlaut	y"	y"

Table C-3 lists the two-stroke and three-stroke compose sequences for multinational mode.

In three-stroke sequences, you can enter required characters in any order unless the table states "order sensitive." You must enter all two-stroke sequences in the order shown.

When you see (sp), press the space bar.

Table C-3 Compose Sequences for Multinational Character Set Mode

Composite Character	Meaning	Three-Stroke Sequence	Two-Stroke Sequence
British Keyboard			
£	pound sign	l- or L- or l= or L=	
\	backslash	/ <	

Table C-3 (Cont.) Compose Sequences for Multinational Character Set Mode

Composite Character	Meaning	Three-Stroke Sequence	Two-Stroke Sequence
Flemish Keyboard			
£	pound sign	-L or -I or =L or =I	
§	section	Is or IS or sO or oS	
'	apostrophe	' (sp)	
ù	u grave	'u	
è	e grave	'e	
French Canadian Keyboard			
à	a grave	'a	'a
â	a circumflex	^a	^a
ç	c cedilla	,c	
é	e acute	'e	'e
ê	e circumflex	^e	^e
è	e grave	'e	'e
î	i circumflex	^i	^i
ô	o circumflex	^o	^o
ù	u grave	'u	'u
û	u circumflex	^u	^u
Danish Keyboard			
#	number sign	+ +	
'	apostrophe	' (sp)	
@	commercial at	a a or A A	
'	single quote	'(sp)	
æ	a e ligature	a e order sensitive	
Ä	A umlaut	..A	..A
Å	A ring	*A	
Ø	O slash	O/	
ä	a umlaut	..a	..a
å	a ring	*a	
ø	o slash	o /	
ü	u umlaut	..u	..u

Compose Sequences

Table C-3 (Cont.) Compose Sequences for Multinational Character Set Mode

Composite Character	Meaning	Three-Stroke Sequence	Two-Stroke Sequence
Finnish Keyboard			
#	number sign	+ +	
@	commercial at	a a or A A or aA	
'	apostrophe	'(sp)	
"	quotations	"(sp)	
Ä	A umlaut	"A	
Ö	O umlaut	"O	
Å	A ring	*A	
Ü	U umlaut	"U	
é	e acute	'e	
å	a ring	*a	
ä	a umlaut	a"/	
ö	o umlaut	o"	
ü	u umlaut	"u	
German Keyboard			
#	pound sign	+ +	
'	apostrophe	'(sp)	
"	quotations	"(sp)	
Ä	A umlaut	"A	
Ö	O umlaut	"O	
§	section sign	sO or !S or s!	
Ä	A umlaut	"A	
Ö	O umlaut	"O	
Ü	U umlaut	"U	
ä	a umlaut	"a/	
ö	o umlaut	"o	
ü	u umlaut	"u	
^	circumflex character	^(sp)	
'	opening single quote	'(sp)	
ß	German sharp s	ss	

Table C-3 (Cont.) Compose Sequences for Multinational Character Set Mode

Composite Character	Meaning	Three-Stroke Sequence	Two-Stroke Sequence
Dutch Keyboard			
£	pound sign	-l or -L or =l or =L	
'	apostrophe	'(sp)	
"	quotations	"(sp)	
¼	fraction one-quarter	1 4 order sensitive	
¼	fraction one-quarter	1 4 order sensitive	
¾	three quarters	3 4 order sensitive	
ij	i j sign	i j order sensitive	
½	fraction one-half	1 2 order sensitive	
Florin		f- order sensitive	
'	opening single quote	'(sp)	
Italian Keyboard			
£	pound sign	-l or -L or =l or =L	
'	apostrophe	'(sp)	
"	quotations	"(sp)	
°	degree sign	°	
§	section sign	os or OS or !S or !s or Os or OS	
^	circumflex accent	^(sp)	
à	a grave	'a	'a
é	e acute	'e	
è	e grave	'e	
ì	i grave	'i	
ò	o grave	'o	
ù	u grave	'u	

Compose Sequences

Table C-3 (Cont.) Compose Sequences for Multinational Character Set Mode

Composite Character	Meaning	Three-Stroke Sequence	Two-Stroke Sequence
Swiss (French) Keyboard			
'	apostrophe	'(sp)	
"	quotations	"(sp)	
à	a grave	'a	
ä	a umlaut	..a	
ç	c cedilla	,c	
é	e acute	'e	
è	e grave	'e	
ê	e circumflex	^e	^e
î	i circumflex	^i	^i
ô	o circumflex	^o	^o
ö	o umlaut	..o	
û	u circumflex	^u	^u
ù	u grave	'u	'u
ü	u umlaut	..u	
Swiss (German) Keyboard			
'	apostrophe	'(sp)	
"	quotations	"(sp)	
à	a grave	'a	'a
ä	a umlaut	..a	
ç	c cedilla	,c	
é	e acute	'e	
è	e grave	'e	
ê	e circumflex	^e	^e
î	i circumflex	^i	^i
ô	o circumflex	^o	^o
ö	o umlaut	..o	
û	u circumflex	^u	^u
ù	u grave	'u	'u
ü	u umlaut	..u	

Table C-3 (Cont.) Compose Sequences for Multinational Character Set Mode

Composite Character	Meaning	Three-Stroke Sequence	Two-Stroke Sequence
Swedish Keyboard			
'	apostrophe	'(sp)	
"	quotations	"(sp)	
#	number sign	+ +	
Å	A ring	*A	
Ä	A umlaut	"A	
É	E acute	'E	
Ö	O umlaut	"O	
Ü	U umlaut	"U	
å	a ring	*a	
ä	a umlaut	"a	
é	e acute	'e	
ö	o umlaut	"o	
ü	u umlaut	"u	
Norwegian Keyboard			
'	apostrophe	'(sp)	
"	quotations	"(sp)	
#	number sign	+ +	
Å	A ring	*A	
Ä	A umlaut	"A	
@	commercial at	a a or A A	
Æ	A E ligature	AE order sensitive	
Ø	O slash	O/	
å	a ring	a*	
æ	a e ligature	a e order sensitive	
ø	o slash	o/	
^	circumflex accent	^(sp)	
'	opening single quote	'(sp)	
~	tilde	~(sp)	

Compose Sequences

Table C-3 (Cont.) Compose Sequences for Multinational Character Set Mode

Composite Character	Meaning	Three-Stroke Sequence	Two-Stroke Sequence
French/Belgian Keyboard			
'	apostrophe	'(sp)	
"	quotations	"(sp)	
£	pound sign	-l or -L or =l or =L	
§	section sign	oS or os or !S or !s or Os or OS or OS or Os	
°	degree sign	O°	
à	a grave	'a	
ç	c cedilla	c,	
é	e acute	'e	
è	e grave	'e	
ù	u grave	'u	
'	opening single quote	'(sp)	
^	circumflex accent	^(sp)	
Spanish Keyboard			
'	apostrophe	'(sp)	
"	quotations	"(sp)	
£	pound sign	-l or -L or =l or =L	
§	section sign	oS or os or !S or !s or Os or OS or OS or Os	
¡	inverted !	!!	
¿	inverted ?	??	
°	degree sign	°O	
Ñ	N tilde	°N	
^	circumflex character	^(sp)	
'	opening single quote	'(sp)	
ñ	n tilde	°n	
~	tilde	~(sp)	
ç	c cedilla	c,	

Table C-3 (Cont.) Compose Sequences for Multinational Character Set Mode

Composite Character	Meaning	Three-Stroke Sequence	Two-Stroke Sequence
Portugese Keyboard			
'	apostrophe	'(sp)	
"	quotations	(sp)"	
@	commercial at	a a or A A	
Ã	A tilde	~A	
Ç	C cedilla	C,	
Õ	O tilde	~O	
ã	a tilde	~a	
õ	o tilde	~o	
'	opening single quote	'(sp)	
^	circumflex character	^(sp)	



D

National Keyboards for VT220 Emulation

This appendix provides illustrations of all national keyboards for VT220 terminal emulation, in the following order:

- North American
- British
- Flemish-Belgian
- Canadian-French
- Danish LK201_AD
- Danish LK201_ED
- Finnish
- French
- German
- Dutch
- Italian
- Norwegian LK201_AN
- Norwegian LK201_EN
- Spanish
- Swedish
- Swiss-French
- Swiss-German

National Keyboards for VT220 Emulation

Figure D-1 North American Keyboard

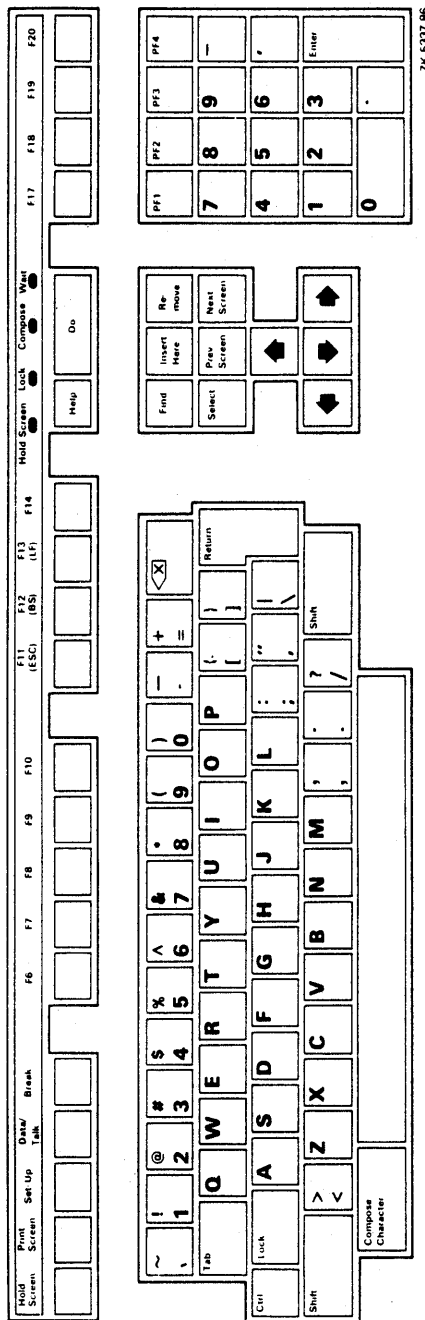
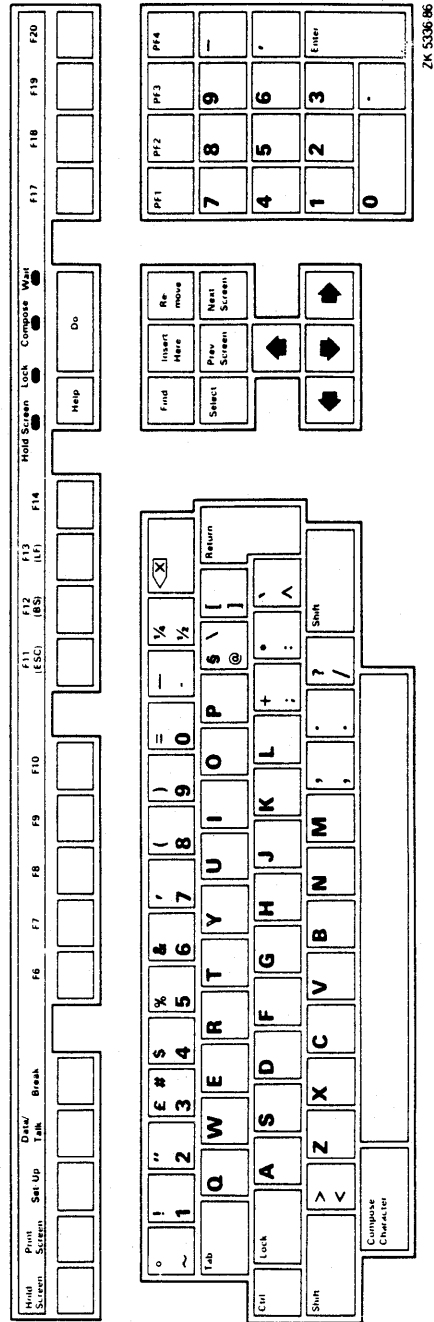

Figure D-2 British Keyboard



National Keyboards for VT220 Emulation

Figure D-3 Flemish-Belgian Keyboard

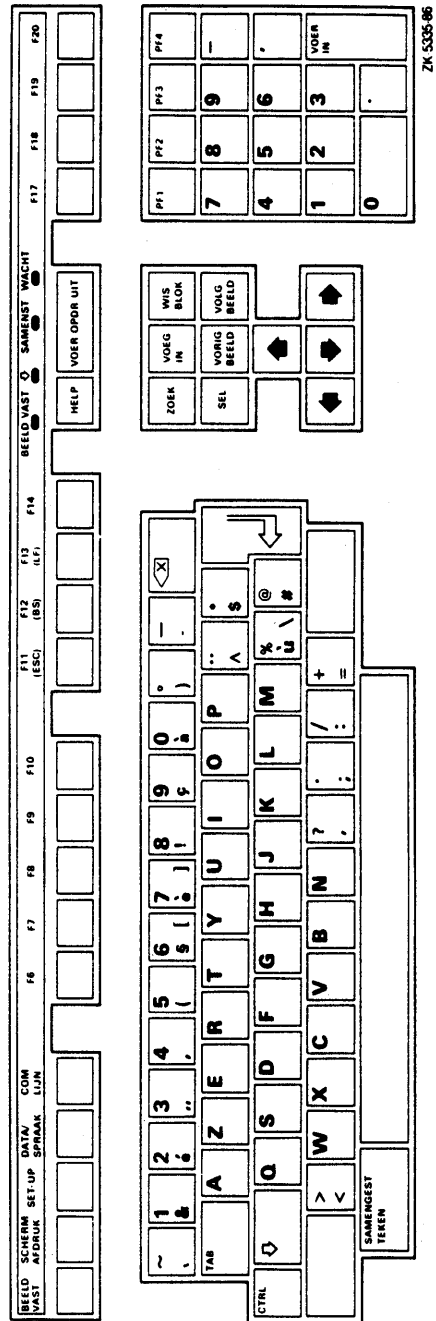
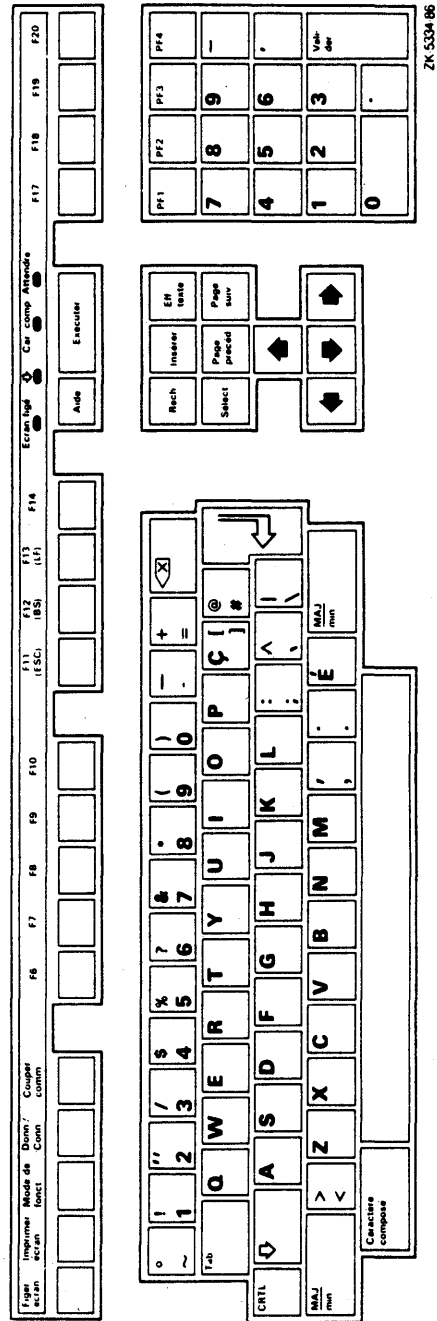

Figure D-4 Canadian-French Keyboard



National Keyboards for VT220 Emulation

Figure D-5 Danish LK201_AD Keyboard

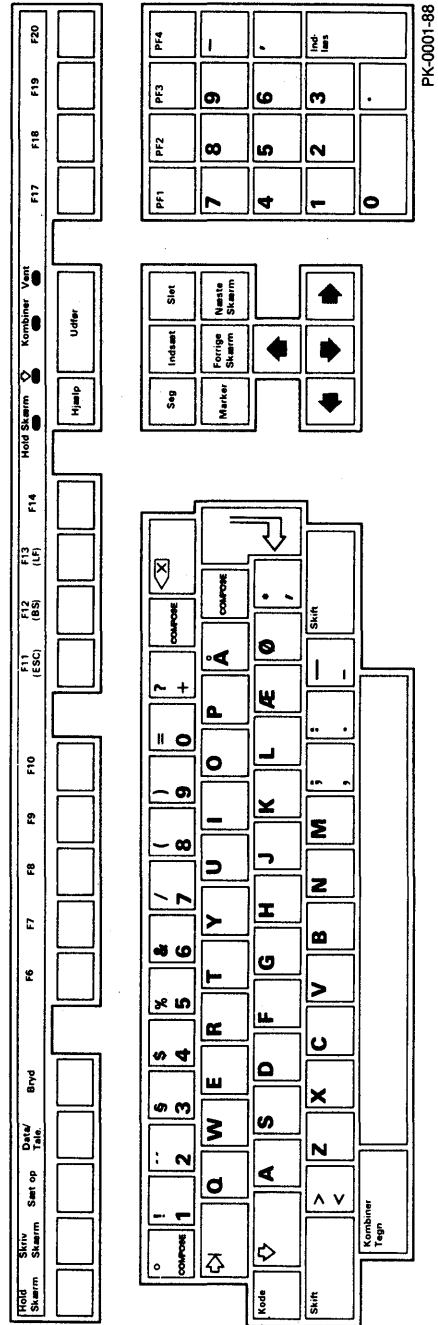
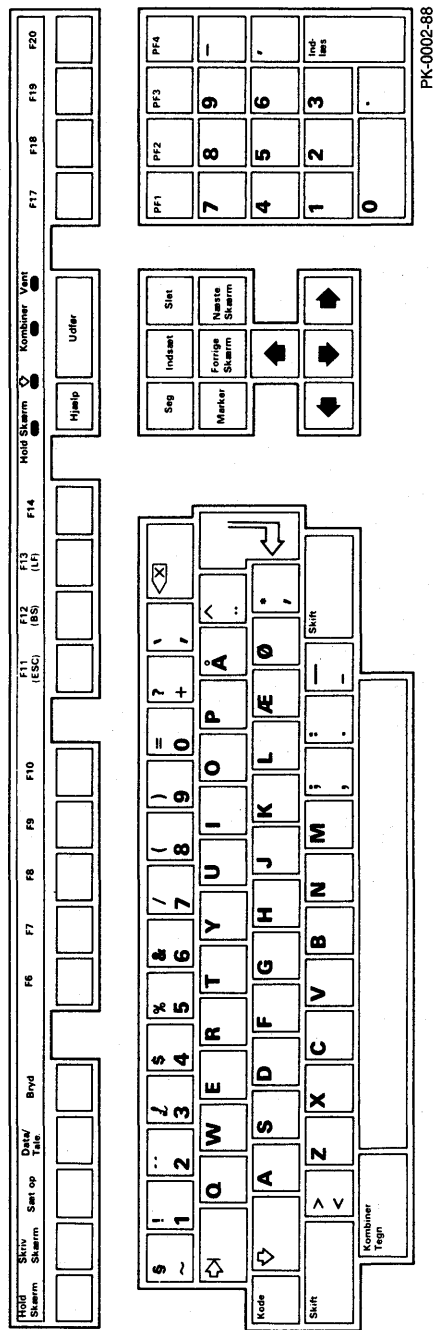

Figure D-6 Danish LK201_ED Keyboard



National Keyboards for VT220 Emulation

Figure D-7 Finnish Keyboard

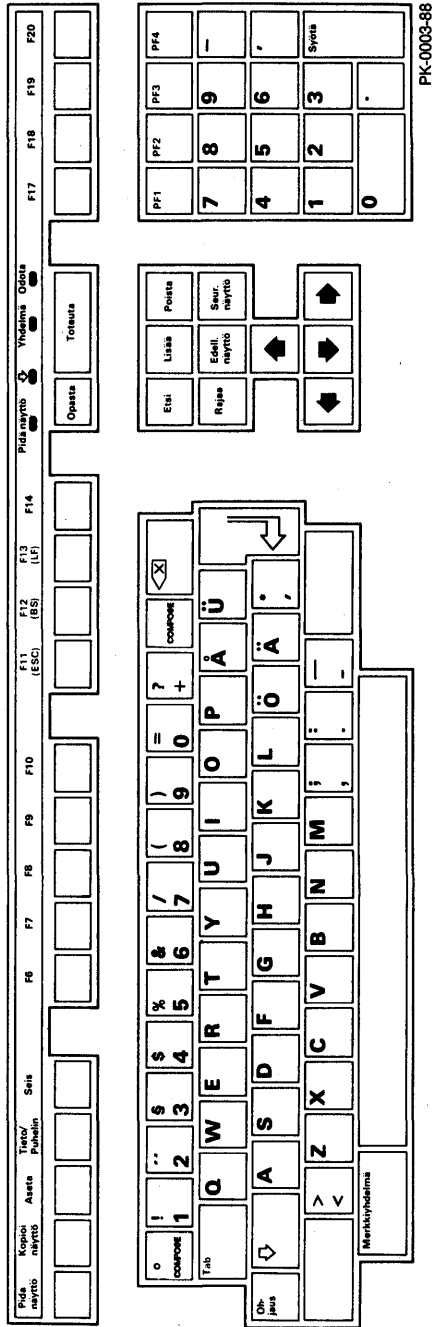
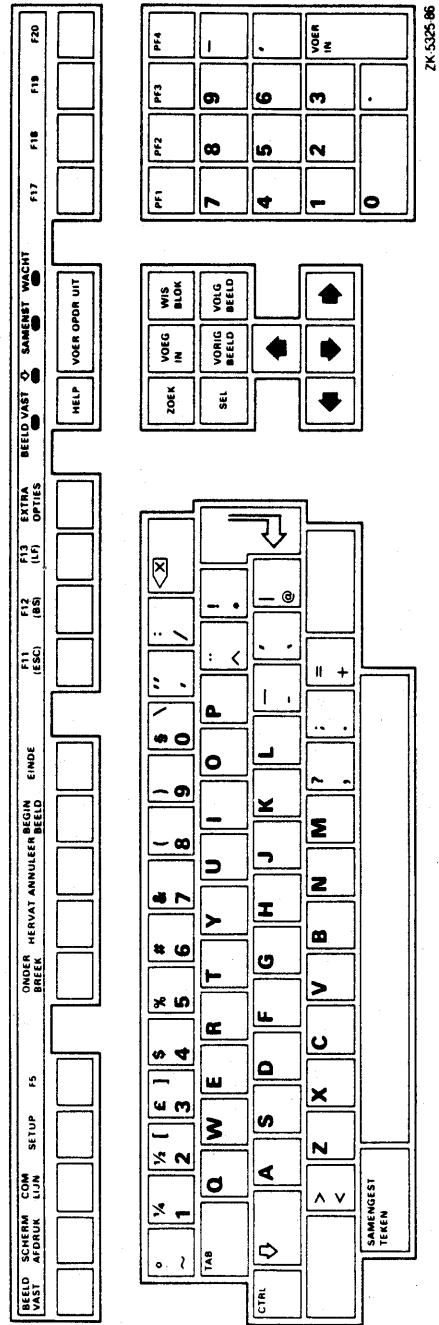

Figure D-10 Dutch Keyboard



National Keyboards for VT20 Emulation

Figure D-11 Italian Keyboard

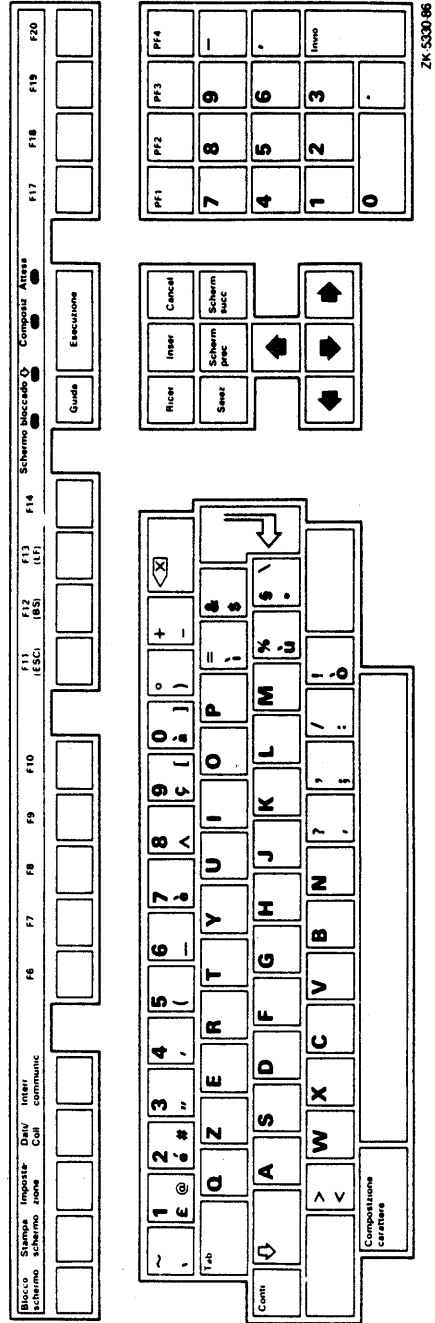
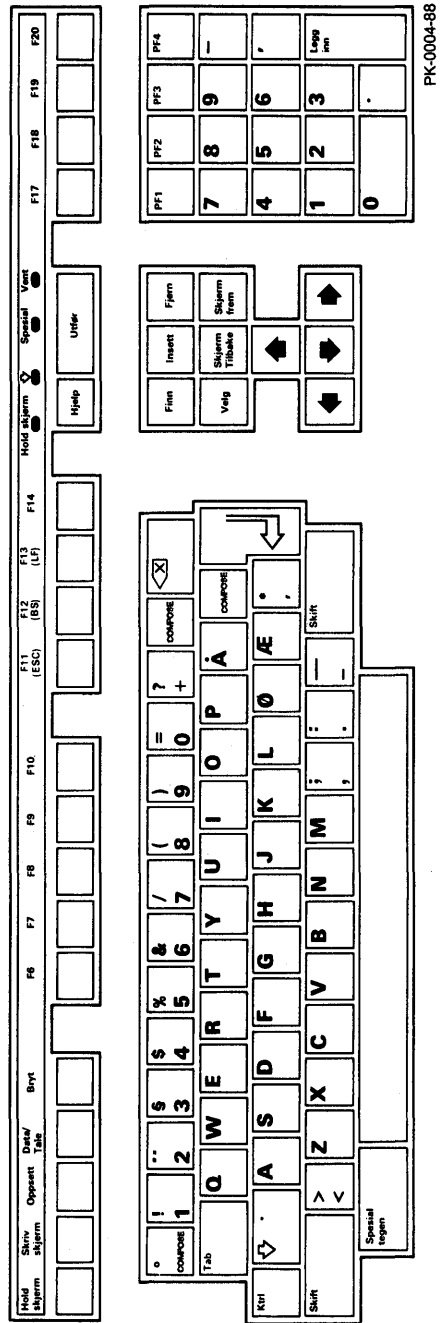

Figure D-12 Norwegian LK201_AN Keyboard



National Keyboards for VT220 Emulation

Figure D-13 Norwegian LK201_EN Keyboard

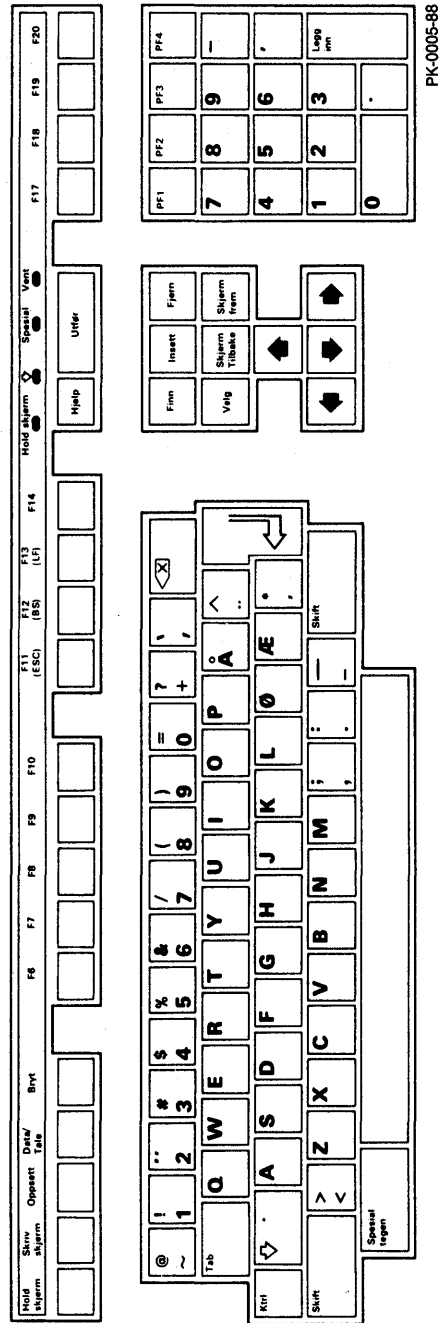
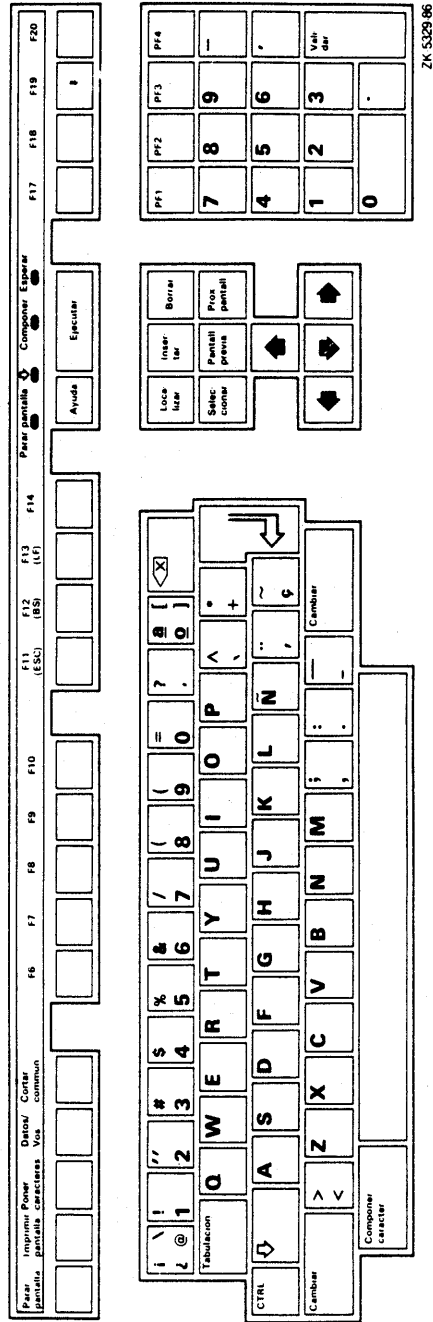

Figure D-14 Spanish Keyboard



ZK 5329 86

National Keyboards for VT220 Emulation

Figure D-15 Swedish Keyboard

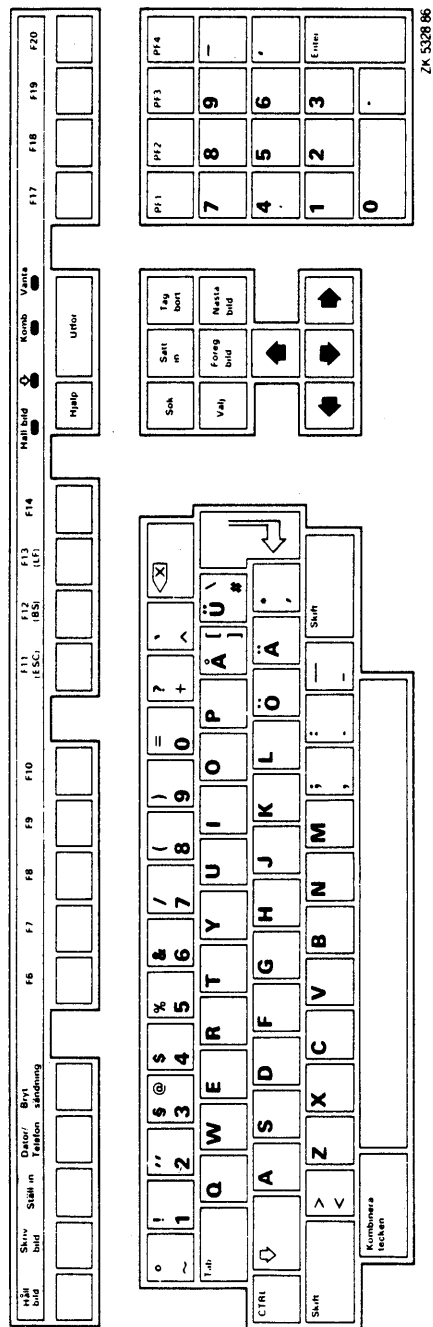
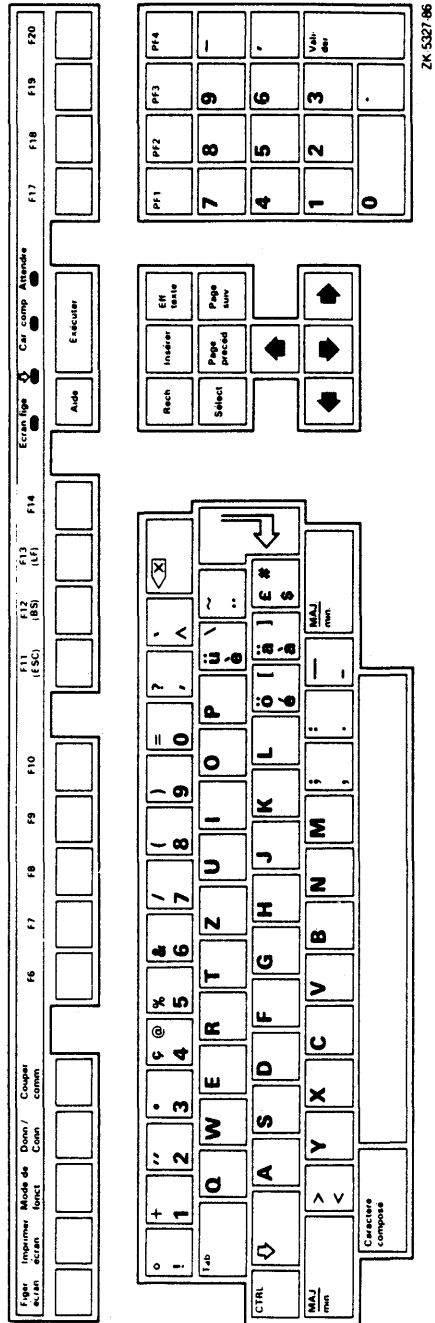

Figure D-16 Swiss-French Keyboard



E

Systemwide Logical Names

Table E-1 lists systemwide logical names.

Table E-1 Systemwide Logical Names by Facility

Facility	Logical Name
VT220-Emulator	UIS\$VT_AUTO_WRAP_MODE
	UIS\$VT_ANSWERBACK
	UIS\$VT_AUTO_ANSWERBACK
	UIS\$VT_AUTO_WRAP_MODE
	UIS\$VT_CURSOR_KEY_MODE
	UIS\$VT_ENABLE_MBX_EVENTS
	UIS\$VT_ENABLE_OSC_STRINGS
	UIS\$VT_LOCK_USER_FEATURES
	UIS\$VT_NEW_LINE_MODE
	UIS\$VT_TAB_STOPS
	UIS\$VT_UDK_LOCK
	UIS\$VT_FONT_DEFAULT
	UIS\$VT_ICON_PLACEMENT
	UIS\$VT_ENABLE_LIVE_ICON
	UIS\$VT_USE_FAKE_ICON
	UIS\$VT_DISABLE_ICON_PICTURE
	UIS\$VT_ENABLE_ICON_UPDATE
	UIS\$VT_COMPLEMENT_ICON
	UIS\$VT_DEFER_ICON_UPDATE
	UIS\$VT_ENABLE_CUT
	UIS\$VT_ENABLE_PASTE
	UIS\$VT_PASTE_FORMAT
	UIS\$VT_BUTTON_MAP
	UIS\$VT_CURSOR_BLINK
	UIS\$VT_ENABLE_LOCATOR
	UIS\$VT_USER_PREFERENCE_SET
	UIS\$VT_FAST_SUSPEND
	UIS\$VT_ALTERNATE_ID
	UIS\$VT_FONT_CHANGE_THRESHOLD
	UIS\$VT_BUGCHECK_ON_ERROR
	UIS\$VT_LOCK_MENU_OPTIONS
	UIS\$VT_DISABLE_DELETE_OPTION

Systemwide Logical Names

Table E-1 (Cont.) Systemwide Logical Names by Facility

Facility	Logical Name
	UIS\$VT_DISABLE_ADDOPT_OPTION
	UIS\$VT_DISABLE_SHRINK_OPTION
	UIS\$VT_DISABLE_RESIZE_OPTION
	UIS\$VT_BANNER
	UIS\$VT_SPACING_DEF
	UIS\$VT_SPACING_132
	UIS\$VT_SPACING_080
	UIS\$VT_POINT_DEF
	UIS\$VT_POINT_132
	UIS\$VT_POINT_080
	UIS\$VT_PRIVATE_COLOR_MAP
	UIS\$VT_PLANE_COUNT
	UIS\$VT_I_01
	UIS\$VT_I_02
	UIS\$VT_I_03
	UIS\$VT_I_04
	UIS\$VT_I_05
	UIS\$VT_I_06
	UIS\$VT_I_07
	UIS\$VT_FAMILY_DEF
	UIS\$VT_SPACING_DEF
	UIS\$VT_POINT_DEF
	UIS\$VT_FAMILY_080
	UIS\$VT_SPACING_080
	UIS\$VT_POINT_080
	UIS\$VT_FAMILY_132
	UIS\$VT_SPACING_132
	UIS\$VT_POINT_132
Tektronix 4010/4014 emulator	UIS\$VT_ENABLE_COPY
	UIS\$VT_ENABLE_PASTE
	UIS\$VT_PASTE_FORMAT
	UIS\$VT_BUTTON_MAP

Index

A

- Automatic login • 2-8
 - using simultaneously with interactive login • 2-24
- Autorepeat keyboard function
 - setup • 2-12

B

- Background color
 - display • 2-9
 - window • 2-9
- Banner • 3-3
 - icon • 3-3
 - KB (keyboard) • 3-3
 - window options • 3-3
- Bell volume
 - setup • 2-12.1

C

- Carriage return
 - automatic • 2-17
 - logical • 2-17
- Change Active Window function key • 1-8
- Changing window size
 - using DCL • 3-9
 - using pointer • 3-5
- Color setup
 - preferred • 2-14
 - on color system • 2-16
 - on intensity system • 2-15
 - on monochrome (bitonal) system • 2-15
 - standard • 2-9
 - on color system • 2-11
 - on intensity system • 2-11
 - on monochrome (bitonal) system • 2-9
- Color system
 - standard color setup • 2-11
- Compose sequences • C-1
- Control keys

- Control keys (cont'd.)
 - See Function keys
- Copying • 3-9
- Copying and pasting • 3-9
- Cutting and pasting
 - see Copying and pasting • 3-9
- Cycling the keyboard • 3-8

D

- Deleting a window • 3-5
- Disabling
 - Workstation Options menu attributes • 2-23
- Display manager process
 - restarting • 2-2

E

- Escape sequence
 - generating • B-10
- Escape sequences • B-10

F

- Foreground color
 - pointer • 2-9
 - window • 2-9
- Form feed
 - automatic • 2-17
 - logical • 2-17
- Function keys • 1-7 to 1-8
 - Change Active Window • 1-8
 - F5 (CYCLE) • 3-8
 - Hold Screen • 1-7
 - Operator Window • 1-8
 - Switch Windowing System • 1-8
 - Tektronix 4010/4014 terminal emulation • 2-5
 - VT220 terminal emulation • 2-3

Index

G

Getting Started window • 1-2

H

Help

VAXstation • 2-2

Help key • 1-3

Hold Screen function key • 1-7

I

Icon

definition of • 1-1

Intensity system

standard color setup • 2-11

K

Keyboard

autorepeat • 2-12

character option setup • 2-12.1

connecting to a window • 3-1

cycling • 3-8

function keys

See Function keys

interaction with VT220 emulation • 3-1

language

setup • 2-13

lock state

setup • 2-13

setup • 2-12

Keyclick volume • 2-12.1

L

Language

keyboard setup • 2-13

Logging on • 3-1

Logical names • E-1

M

Menu

definition of • 1-3

exiting • 1-4

icon • 3-3

Messages

status • 1-1

Modifying

Workstation Options menu attributes • 2-23,
2-24

Monochrome (bitonal) system

standard color setup • 2-9

Mouse

how to use • 1-4.1 to 1-5

moving windows using • 3-9

printing portion of screen using • 2-5

SELECT button • 1-4.1

selecting a menu option • 2-1

using the keyboard • 1-5

Moving windows • 3-9

O

Operator window

connecting to • 1-8, 1-9

function key • 1-8

functions on color and intensity systems • 1-9

how to use • 1-9 to 1-10

P

Pasting • 3-9

Pen

See Stylus

Pointer

background color

selecting • 2-9

definition of • 1-4

foreground color

selecting • 2-9

moving windows using • 3-9

moving with mouse • 1-4.1

moving with puck • 1-7

moving with stylus • 1-7

printing portion of screen using • 2-5

- Pointer (cont'd.)
 - SELECT button • 1-4
 - setup • 2-14
- Pointing device
 - how to use • 1-4
 - mouse • 1-4.1
 - puck • 1-7
 - stylus • 1-7
 - types • 1-4
- Print destination
 - selecting from Workstation Setup menu • 2-17
- Printer setup • 2-16
- Printing portion of screen • 2-5, 2-6
- Print operation
 - canceling • 2-6
 - changing print destination • 2-6, 2-17
 - sending to remote device • 2-6
 - using pointer • 2-5
- Print queue • 2-17
- Print status
 - selecting from Workstation Setup menu • 2-17
- Puck • 1-5
 - how to use • 1-7
 - using with Tektronix 4010/4014 terminal emulation • 2-5

R

- Restoring settings • 2-22

S

- Saving current settings • 2-22
- Screen display
 - printing • 2-5
 - writing to file • 2-6
- Screen saver
 - disabling • 2-18
- Setting up the VAXstation
 - See Workstation Setup menu
- Software
 - VMS Workstation
 - See VMS Workstation software
- Stylus • 1-5
 - how to use • 1-7
 - SELECT button
 - setup • 2-14

- Stylus (cont'd.)
 - using with Tektronix 4010/4014 terminal emulation • 2-5
- Switch Windowing System
 - function key • 1-8
- Systemwide logical names
 - list • E-1

T

- Tablet
 - how to use • 1-5 to 1-7
- Tektronix 4010/4014 systemwide logicals • E-2
- Tektronix 4010/4014 terminal emulation
 - alpha mode • A-16
 - character size • A-17
 - margin processing • A-16
 - ASCII character codes • A-2
 - attributes • 2-18
 - bypass condition • A-15
 - changing operational modes • A-14
 - clearing the screen • A-15
 - DELETE character • 2-18
 - description of VAXstation support • A-1 to A-20
 - EOT character • 2-18
 - escape sequences • A-10 to A-14
 - delete character • A-13
 - ignored • A-10
 - miscellaneous • A-13
 - request terminal status • A-10
 - select bypass condition • A-11
 - select character size • A-11
 - select point plot mode • A-11
 - select vector patterns • A-12
 - set alpha mode • A-11
 - set GIN mode • A-11
 - set LCE flag • A-12
 - features • 2-4
 - function keys • 2-5
 - graphic input (GIN) mode • 2-5, A-20
 - graph mode • A-17
 - drawing command • A-18
 - encoding of coordinates • A-18
 - implementation restrictions • A-1
 - modes and functions • A-1
 - point plot mode • A-19
 - RETURN character • 2-18
 - screen addressing • A-2
 - setup support • A-2

Index

Terminal emulation

- See Tektronix 4010/4014 terminal emulation
- See Tektronix 4125 terminal emulation
- See VT220 terminal emulation

U

UISBG.DAT

- modifying • 2-24
- use of • 2-24

V

VMS Workstation software

- getting started • 2-1
- help • 2-2

VT220 terminal emulation • 2-3 to 2-4

- attributes • 2-19
 - character set • 2-19, 2-20
 - keypad mode • 2-20
 - margin bell • 2-20
 - page length • 2-20
 - SIXEL scrolling • 2-21
 - text cursor • 2-21
 - transmission mode • 2-21
 - VT terminal type • 2-21
 - warning bell • 2-22
- compose sequences • C-1
- connecting to keyboard • 3-1
- function keys • 2-3

W

Window

- background color
 - selecting • 2-9
- banner • 3-3
 - icon • 3-3
 - KB (keyboard) • 3-3
 - window options • 3-3
- changing the size
 - using DCL • 3-9
 - using pointer • 3-5
- connecting to • 3-8
- creating • 2-3, 3-1
- cycling • 1-8

Window (cont'd.)

- definition of • 1-1
- deleting • 3-5
- foreground color
 - selecting • 2-9
- getting started • 1-2
- help • 2-2
- managing memory • 3-1
- moving • 3-9
- options
 - change the size • 3-5
 - delete • 3-5
 - pop in front • 3-5
 - push behind • 3-5
 - shrink to an icon • 3-6
- status message • 1-1
- Tektronix 4010/4014 terminal emulation • 2-4
- terminal-emulator • 1-1
- VT220 terminal emulation • 2-3, 3-1
- Window Options menu • 3-4 to 3-8
- Workstation Options menu • 2-1 to 2-25
 - disabling • 2-23
 - help • 2-2
 - invoking • 2-1
 - modifying • 2-23, 2-24
 - printing portion of screen • 2-5
 - selecting an option • 2-1
 - setting up the workstation • 2-7
 - Tektronix 4010/4014 Terminal Emulation • 2-4
 - VT220 terminal emulation • 2-3, 3-1
- Workstation screen
 - background color
 - selecting • 2-9
- Workstation setup
 - automatic login • 2-8
 - bell volume • 2-12.1
 - color display
 - standard • 2-9
 - display background color • 2-9
 - exiting • 2-23
 - keyboard • 2-12
 - keyboard autorepeat • 2-12
 - keyboard language • 2-13
 - keyclick volume • 2-12.1
 - lock state • 2-13
 - menu • 2-7 to 2-23
 - pointer background color • 2-9
 - pointer foreground color • 2-9
 - pointer setup • 2-14
 - button order • 2-14
 - stylus SELECT button • 2-14

Workstation setup (cont'd.)

- preferred color • 2-14
- print destination • 2-17
- printer • 2-16
 - aspect ratio • 2-16
 - color conversion • 2-17
- print queue management • 2-17
- print status • 2-17
- restoring to last settings • 2-22
- restoring to original default settings • 2-22
- saving current settings • 2-22
- screen saver period • 2-18
- Tektronix 4010/4014 terminal emulation
 - attributes • 2-18
- VT220 terminal emulation attributes • 2-19

- character set • 2-19
 - window background color • 2-9
 - window foreground color • 2-9
 - workstation type • 2-22
- Workstation software
- See VMS Workstation software
- Workstation types • 1-1
- Workstation types, color
- See Color system
- Workstation types, intensity
- See Intensity system
- Workstation types, monochrome system
- See Monochrome (bitonal) system

Do Not Tear - Fold Here and Tape

digital™



No Postage
Necessary
if Mailed in the
United States

BUSINESS REPLY MAIL

FIRST CLASS PERMIT NO. 33 MAYNARD, MASS.

POSTAGE WILL BE PAID BY ADDRESSEE

VWS Engineering
Digital Equipment Corporation
110 Spitbrook Rd. ZKO3-2/S30
Nashua, New Hampshire 03062-2698

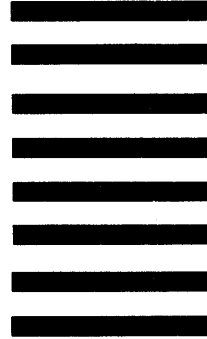

Do Not Tear - Fold Here

D

D

D

D

