

# VT 14 USERS MANUAL

digital

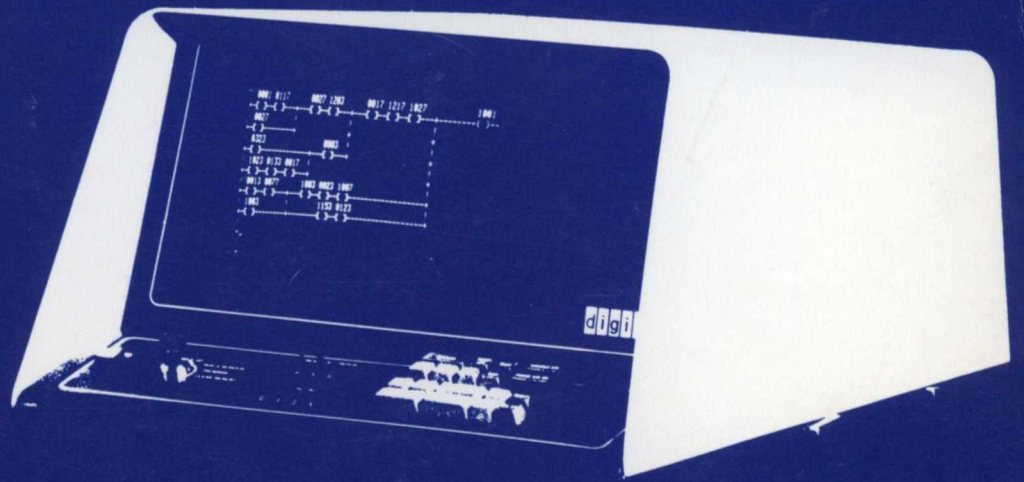

INDUSTRIAL 14 FAMILY

# 14

OF CONTROLLERS

# VT14 USER'S MANUAL

1st Edition, February 1974

Copyright © 1974 by Digital Equipment Corporation

The material in this manual is for informational purposes and is subject to change without notice.

Digital Equipment Corporation assumes no responsibility for any errors which may appear in this manual.

Printed in U.S.A.

The following are trademarks of Digital Equipment Corporation, Maynard, Massachusetts:

|           |              |
|-----------|--------------|
| DEC       | PDP          |
| FLIP CHIP | FOCAL        |
| DIGITAL   | COMPUTER LAB |

## CONTENTS

|                  | Page  |      |
|------------------|---|------|
| <b>CHAPTER 1</b> | <b>GETTING ON THE AIR</b>   |      |
|                  | LET'S ENTER A CIRCUIT . . . . .                                     | 1-2  |
|                  | ENTERING A LARGER CIRCUIT . . . . .                                 | 1-2  |
|                  | CORRECTING A MISTAKE WITHIN A CIRCUIT . . . . .                     | 1-3  |
|                  | CORRECTING CIRCUITS ALREADY STORED IN 14 MEMORY . . . . .           | 1-3  |
|                  | RUNNING THE CONTROL PROGRAM . . . . .                               | 1-3  |
|                  | ENTERING A TIMER OR A COUNTER CIRCUIT . . . . .                     | 1-3  |
|                  | SUMMARY . . . . .   | 1-4  |
| <b>CHAPTER 2</b> | <b>WRITING YOUR CONTROL PROGRAM</b>                                 |      |
|                  | I/O NUMBERS . . . . .   | 2-1  |
|                  | INTERNAL I/O GROUPINGS . . . . .                                    | 2-1  |
|                  | ADJUSTING THE INTERNAL I/O GROUPING . . . . .                       | 2-3  |
|                  | OUTPUT CIRCUITS . . . . .   | 2-3  |
|                  | RETENTIVE MEMORIES . . . . .  | 2-6  |
|                  | SHIFT REGISTERS . . . . .   | 2-6  |
|                  | TIMERS . . . . .  | 2-7  |
|                  | EVENT COUNTERS . . . . .  | 2-9  |
|                  | UP/DOWN COUNTERS . . . . .  | 2-10 |
|                  | NON-RETENTIVE INTERNAL FUNCTIONS . . . . .                          | 2-11 |
|                  | CIRCUITS CONTAINING INPUTS THAT ARE WIRED NORMALLY-CLOSED . . . . . | 2-11 |
| <b>CHAPTER 3</b> | <b>ENTERING THE PROGRAM</b>   |      |
|                  | CLEARING 14 MEMORY . . . . .  | 3-1  |
|                  | ENTERING A CIRCUIT . . . . .  | 3-1  |
|                  | STORING CIRCUITS . . . . .  | 3-5  |
|                  | EDITING CIRCUITS . . . . .  | 3-5  |
|                  | REMOVING A CIRCUIT FROM MEMORY . . . . .                            | 3-6  |
|                  | DISPLAYING A CIRCUIT . . . . .                                      | 3-7  |
|                  | ENTERING A SHIFT CIRCUIT . . . . .                                  | 3-7  |
|                  | PRESETTING TIMERS, EVENT COUNTERS, AND UP/DOWN COUNTERS . . . . .   | 3-8  |
|                  | ENTRY ERRORS . . . . .  | 3-8  |
| <b>CHAPTER 4</b> | <b>ON-LINE USE OF THE VT14</b>                                      |      |
|                  | CHECKING I/O STATUS . . . . .                                       | 4-1  |
|                  | RUNNING THE CONTROL PROGRAM . . . . .                               | 4-1  |
|                  | MONITORING A CONTROL CIRCUIT . . . . .                              | 4-1  |
|                  | SUMMARY OF VT14 MODES . . . . .                                     | 4-2  |
|                  | Force I/O Mode . . . . .  | 4-2  |
|                  | Disabling I/O Points . . . . .                                      | 4-2  |
|                  | Forcing Disabled I/O . . . . .                                      | 4-4  |
|                  | Using the Disable/Force Feature . . . . .                           | 4-4  |
|                  | Forcing An Enabled Output . . . . .                                 | 4-5  |
|                  | CHANGING A CIRCUIT . . . . .  | 4-6  |
|                  | HINTS FOR THE USE OF THE VT14 . . . . .                             | 4-6  |

## CONTENTS (Cont)

|                   |                                      | Page |
|-------------------|--------------------------------------|------|
| <b>APPENDIX A</b> | <b>VT14 PROGRAM DOCUMENTATION</b>    |      |
| <b>APPENDIX B</b> | <b>CASCADING A TIMER AND COUNTER</b> |      |
| <b>APPENDIX C</b> | <b>VT14 INSTALLATION</b>             |      |
| <b>APPENDIX D</b> | <b>CIRCUIT GRID FORMS</b>            |      |

## ILLUSTRATIONS

| Figure No. | Title   | Page |
|------------|---|------|
| 1-1        | VT14 Programming Terminal . . . . .   | 1-1  |
| 1-2        | A Simple Control Circuit . . . . .  | 1-2  |
| 1-3        | A More Complex Control Circuit . . . . .  | 1-2  |
| 2-1        | I/O Partitioning . . . . .  | 2-1  |
| 2-2        | Internal I/O Groupings . . . . .  | 2-1  |
| 2-3        | Industrial 14 Circuit Format . . . . .  | 2-4  |
| 2-4        | VT14 Circuit Rules . . . . .  | 2-5  |
| 2-5        | Retentive Memory Circuit to Record Full-Depth Reached . . . . .                                   | 2-6  |
| 2-6        | Shift Register Circuit to Track a Reject Part . . . . .   | 2-6  |
| 2-7        | General SR Parallel Load Circuit . . . . .  | 2-7  |
| 2-8        | Industrial 14 Memory Allocation for Shift Registers . . . . .                                     | 2-7  |
| 2-9        | Linking Two Shift Registers . . . . .   | 2-7  |
| 2-10       | Timing Circuit Operation . . . . .  | 2-7  |
| 2-11a      | Timing Diagram . . . . .  | 2-8  |
| 2-11b      | On-Delay Timer Circuit . . . . .  | 2-8  |
| 2-12a      | Timer Lock-Up Circuit . . . . .   | 2-8  |
| 2-12b      | Timer Lock-Up Circuit . . . . .   | 2-8  |
| 2-13a      | Off-Delay Timer Circuit . . . . .   | 2-8  |
| 2-13b      | Off-Delay Timer Circuit . . . . .   | 2-8  |
| 2-14a      | Circuit to Energize an Output for a Fixed Interval After<br>De-Energization of an Input . . . . . | 2-9  |
| 2-14b      | Circuit to Energize an Output for a Fixed Interval After<br>De-Energization of an Input . . . . . | 2-9  |
| 2-15       | Event Counter Circuit to Shut Down a Station After<br>Three Successive Bad Parts . . . . .        | 2-9  |
| 2-16       | Up/Down Counter Circuit to Limit Parts<br>on a Conveyor to a Maximum of Six . . . . .             | 2-10 |
| 2-17       | Clear Timer if Power is Lost . . . . .  | 2-11 |
| 2-18       | Circuit to Clear One Bit of a Shift Register on Power Failure . . . . .                           | 2-11 |
| 2-19       | Start/Stop Circuit with N/O and N/C Contacts . . . . .  | 2-12 |
| 3-1        | Sample Control Circuit . . . . .  | 3-1  |
| 3-2        | VT14 Display Positions . . . . .  | 3-4  |
| 3-3        | Sample Circuit Showing Grid Positions . . . . .   | 3-4  |

## ILLUSTRATIONS (Cont)

| Figure No. | Title   | Page |
|------------|---|------|
| 3-4        | Procedure for Changing a Normally-Open Contact to a Normally-Closed Contact . . . . . | 3-5  |
| 3-5        | Procedure for Changing the Position of an Element . . . . .                           | 3-6  |
| 3-6        | Procedure to Display a Circuit . . . . .  | 3-7  |
| 3-7        | A Typical Shift Register Control Circuit . . . . .                                    | 3-7  |
| 3-8        | Timer (or Counter) Output 1710 Preset to 369 Seconds (Counts) . . . . .               | 3-8  |
| 3-9a       | Typical Control Circuit Containing an Illegal Vertical Contact . . . . .              | 3-8  |
| 3-9b       | Reformatted to Emphasize the Vertical Contact . . . . .                               | 3-9  |
| 3-9c       | Circuit 3-9a in Legal Format . . . . .  | 3-9  |
| 3-10a      | Branches Illegally Offset . . . . .   | 3-9  |
| 3-10b      | An Element Illegally Drawn Between an Up-Branch and a Down-Branch . . . . .           | 3-9  |
| 4-1        | Sampling Input 476 . . . . .  | 4-1  |
| 4-2        | Typical Display of Intensified Control Circuit Symbols . . . . .                      | 4-2  |
| 4-3        | Disabling Inputs and Outputs from the VT14 . . . . .                                  | 4-3  |
| 4-4        | Input 0476 Disabled . . . . .   | 4-3  |
| 4-5        | Contact 0476 Forced On . . . . .  | 4-4  |
| 4-6        | Automatic-Cycle-Light Control Circuit . . . . .                                       | 4-4  |
| 4-7        | Disabling and Forcing On the CYCLE START and MAIN CYCLE Contacts . . . . .            | 4-5  |
| 4-8        | Sample Circuit to Display Input States . . . . .                                      | 4-7  |
| B-1        | Cascading a 60-Second Timer With a 60-Minute Counter . . . . .                        | B-1  |
| D-1        | Circuit Entry Grid Forms . . . . .  | D-2  |

## TABLES

| Table No. | Title  | Page |
|-----------|--|------|
| 2-1       | Typical Assignment of Internal I/O Numbers . . . . .       | 2-2  |
| 2-2       | Possible Internal Function Groupings . . . . .             | 2-3  |
| 2-3       | Up/Down Counters . . . . .                                 | 2-10 |
| 2-4       | Meaning of Circuit Symbols and Wiring Conditions . . . . . | 2-12 |
| 3-1       | Step-by-Step Circuit Entry Procedure . . . . .             | 3-2  |
| 4-1       | VT14 Modes of Operation . . . . .                          | 4-2  |

# INTRODUCTION

The VT14 Programming Terminal is connected to the Industrial 14/30 and 14/35 Controllers for programming operations. It has an easy-to-use keyboard for entering, displaying, and editing controller programs in ladder diagram form. These diagrams can be checked for accuracy or monitored while in use (including timers, counters, and shift registers) via the CRT display. Other VT14 features are used during start-up operations. These capabilities expedite control circuit design and system troubleshooting.

## HOW THIS MANUAL IS ORGANIZED

The *VT14 Users Manual* provides complete instructions for programming the 14 Controller. Refer to Chapter 1 of the *Industrial 14 Systems Manual* for a description of the 14/30 and 14/35 Controllers. This manual is divided into four chapters:

- Chapter 1: GETTING ON THE AIR**  
Introduction to the VT14, its operation, and capabilities.
- Chapter 2: WRITING YOUR CONTROL PROGRAM**  
Detailed instructions for the design of control circuits for the Industrial 14/30 and 14/35 Controllers.
- Chapter 3: ENTERING THE PROGRAM**  
Detailed instructions for loading the complete control program into the controller's memory from the VT14.
- Chapter 4: ON-LINE USE OF THE VT14**  
Detailed instructions for using the VT14 to assist during checkout and startup of a new machine or for troubleshooting an installed system.
- Appendices:** Appendices include installation and startup procedures for the VT14; examples for programming internal functions; and use of a Teletype console with the VT14.



```
0001 0017      0017 1003      0017 1017 1027      1001
+ [ ]-[ ]-----[ ]-[ ]-----[ ]-[ ]-[ ]-----
0027
+ [ ]-----
0323          0903
+ [ ]-----[ ]-----
1023 0133 0017
+ [ ]-[ ]-[ ]-[ ]-----
0013 0077      1003 0023 1007
+ [ ]-[ ]-[ ]-----[ ]-[ ]-[ ]-----
1003
+ [ ]-----
```

digital

POWER II

RUN & MONITOR  
PROGRAM  
CLEAR MEMORY

PRINT ON PAPER

NUMBER

DISPLAY  
TRACE  
STOP  
PAUSE  
POWER OFF OR  
POWER OFF SW  
DISABLE I/O  
ENABLE I/O  
DISABLE



# CHAPTER 1

## GETTING ON THE AIR

This chapter assumes that the VT14 is connected to the Industrial 14 system. If not, refer to the installation procedure in Appendix C.

The operation of the VT14 can be mastered quickly since the function of the keys is clearly indicated and the display instantly records your entries. Later chapters give the details for taking full advantage of the VT14 and the controller it programs; but before learning all these details, let's first enter a few circuits on the VT14 to appreciate what can be done with this device.

Figure 1-1 shows the VT14 with the major elements of the front panel indicated.

The POWER ON/OFF switch turns the VT14 on and is lit while the terminal is powered.

The MODE switch selects the operations that the VT14 will be allowed to perform. At this point, set it to the PROGRAM position.

The PRESET or POSITION switches are numbered, thumb-wheel switches used to preset timer or counter values or to position the cursor on the screen during editing operations.

The I/O NUMBER switches are numbered, thumbwheel switches used to enter contact numbers for inputs and outputs.

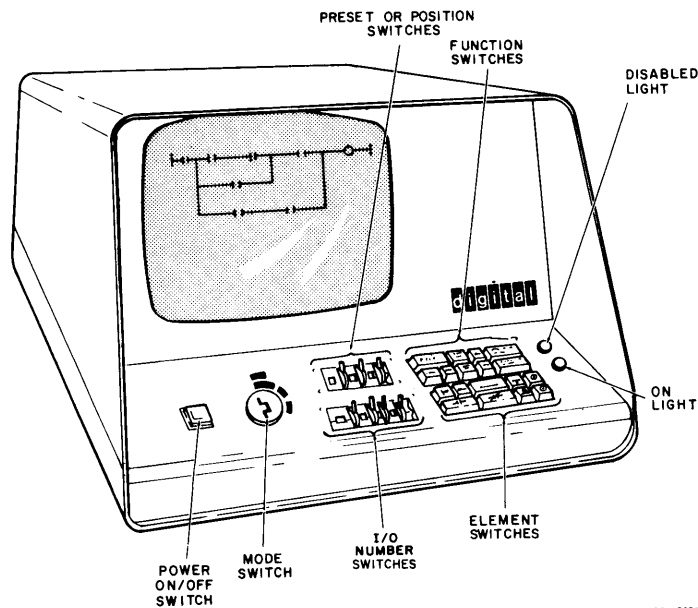

Figure 1-1 VT14 Programming Terminal

The FUNCTION keys are used to tell the VT14 what functions you want to perform: DISPLAY, EDIT, STORE, etc.

The ELEMENT keys are used to enter the control circuit for each output.

Two Indicator Lights tell the status of a selected input or output: Is it on, is it disabled?

**LET'S ENTER A CIRCUIT**

First, blank the screen by striking ERASE.

To enter a normally-open contact for input 200 (Figure 1-2), dial 0200 into the I/O NUMBER switches and press the  $\text{—|—}$  symbol. (All inputs are assigned numbers between 0 and 777.) Notice that the screen immediately displays this contact.

Also notice a small dash on the screen to the right of the contact you've just entered. This is the cursor, a position indicator that always shows where the next element you enter will be placed within the circuit.

To add the normally closed contact for input 201 in series with the contact already on the screen, simply set the I/O NUMBER switches to 0201 and press the  $\text{—|/—}$  symbol.

Since that is the total circuit for output 1000, you can complete the circuit by setting the I/O NUMBER switches to 1000 and pressing the red  $\text{—(O)—}$  symbol. (Outputs are numbered from 1000 to 1377.)

Up to this point, any entry you have made is retained in the VT14. When you are satisfied with the displayed circuit, press the STORE key to record the circuit in the controller's memory.

**ENTERING A LARGER CIRCUIT**

To enter a larger circuit — one with branches within it — remember a few rules:

1. The circuit is entered left to right, top to bottom. In other words, each horizontal path is completed before the next path is started.
2. The output coil (—O—) is always the last element in the first row.
3. When one horizontal line has been completed, the next is started by pressing the next line (  $\text{—|—}$  ) symbol.
4. Branches may be used anywhere within the circuit by positioning a down branch (  $\text{—|↓—}$  ) symbol to initiate the branch and an up branch (  $\text{—|↑—}$  ) symbol to connect the branch.
5. Branches must be aligned vertically. Use the SPACE key to move an up branch over under its down branch; or use the line (  $\text{—|—|—}$  ) symbol to continue a branch out so that the up branch symbol lines up with the down branch.
6. Use as many as eight parallel paths, each with up to 10 contacts, branches, or spaces.

After you have entered a few circuits, you'll see that these rules are really very simple. Try to enter the more complex circuit shown in Figure 1-3.

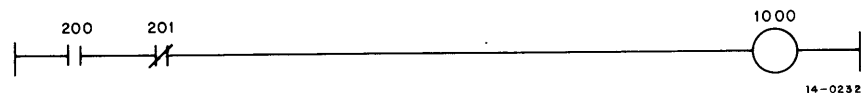

Figure 1-2 A Simple Control Circuit

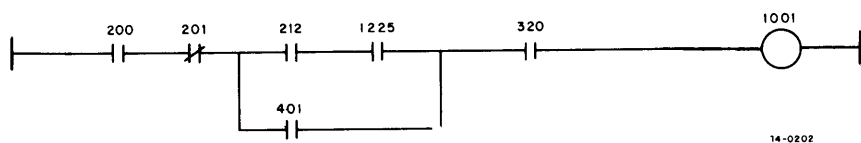

Figure 1-3 A More Complex Control Circuit

First enter the contacts for input 200 and 201 as in the first example. The down branch ( ↓ ) symbol is entered next. Then the normally open contacts for 212 and 1225 are entered, followed by a second down branch ( ↓ ). The first line is completed by entering the normally open contact 320 and the coil for output 1001.

To enter the second row of elements, press the next line ( ↗ ) symbol. The cursor will move to the first position in the second row. Next you must space over to position the up branch under the down branch. To do this, press SPACE twice, then press the up branch ( ↑ ) followed by the normally open contact 401. The second up branch must be properly positioned one place over, but in this case the line key ( ●→ ) is used. An up branch ( ↑ ) completes the circuit.

Use the STORE key to record the circuit within the controller's memory.

### **CORRECTING A MISTAKE WITHIN A CIRCUIT**

The VT14 incorporates editing capability if you press the wrong key. You can change any position within the circuit one at a time. First, you simply tell the VT14 which position in the circuit you wish to modify and second, you tell the VT14 what you want to be in that position.

For editing purposes, a two-digit numbering system is used to identify each position. The first digit (0-7) specifies which of eight horizontal rows; the second digit (0-9) specifies which of ten vertical columns. So elements in the first row are 00, 01, 02, etc; in the second row, 10, 11, 12, etc.

To change a normally open input 320 in position 06 (first row, seventh element), set the POSITION switches to 006, then press the EDIT key. The cursor will move to the position to be edited. (Check to see that the cursor is in the proper position; if you counted positions incorrectly, reset the rotary switches and press EDIT again.) When the cursor is in place, dial the I/O NUMBER switches to the correct input or output, then press the proper key: —[ ]— or —[ ]—. If you want to remove that contact entirely, press the ●→ key.

Other modifications to the circuit may be made in this fashion: Simply dial in the number for the position to be changed, then press EDIT; with the cursor in the proper position, you can press the key for the new element to occupy that position. Since the cursor steps to the next position after each edit, consecutive changes may be made without using the edit key.

### **CORRECTING CIRCUITS ALREADY STORED IN 14 MEMORY**

Easy. Just set the I/O NUMBER switches to the output to be recalled from memory, then press DISPLAY. The VT14 will search the controller's memory and display the circuit for the output. It will simply say NONE if that output has not yet been programmed.

To change a circuit after it has been programmed, simply follow the editing directions above. Or if you want a completely different circuit, simply ERASE the screen and enter the new circuit. In either case, the old circuit will be removed when the altered or new circuit is stored (STORE switch).

### **RUNNING THE CONTROL PROGRAM**

Switching the key switch to the RUN & MONITOR position causes the Industrial 14 to begin executing the control program already loaded into its memory. While this is occurring you are able to view any control circuit, merely by selecting the output in the I/O NUMBER switches and pressing the DISPLAY key.

Notice how any contacts that will "pass current" are intensified on the screen to show you at a glance the current path causing an output to turn on. Likewise, the contact or contacts that are not in their conducting state are quickly identified in monitor mode because they are not intensified.

### **ENTERING A TIMER OR A COUNTER CIRCUIT**

Timers and counters, like shift registers and retentive memories, are achieved within the Industrial 14 and are therefore, called internal functions. They use a block of I/O numbers separate from the external outputs. Timers typically begin with number 1600 and counters around 1700 varying to suit your requirements as discussed in Chapter 2.

To set the value of the timer, first set the I/O NUMBER switches to 1600. For a 32 second delay set the PRESET thumbwheel switches to 032, then press the TIMR SEC key. For a value of 3.2 seconds, the rotary switches would be identical, but the TIMR 0.1 SEC key would be used. The maximum settings are 999 seconds (in 1 second increments) or 99.9 seconds (in 0.1 second increments).

Timers and counters use two internal I/O numbers. For example one timer uses numbers 1600 and 1601. A full control circuit is entered for the even number 1600, which when energized starts the timer and when de-energized clears the timer. The even address contacts, 1500, are instantaneous; the odd address contacts, 1601, are delayed.

In the case of a counter, a control circuit is entered for the even address 1700, which when energized increments the count. The control circuit for the odd address 1701, clears the count when energized. The odd address contacts 1701, close when the preset value is reached.

To establish a counter's value, set the counter number (1700 for example) into the I/O NUMBER switches. Then dial the counter's value into the PRESET switches and press the CNTR function key.

After storing these circuits in the Industrial 14's memory, you can display them and, in the run mode, watch as the current values increment until the preset value is reached.

These two values (TIME or COUNT, and PRESET) are shown on the screen of the VT14 immediately below the output coil of the timer or counter circuit.

#### **SUMMARY**

So now you've played with a VT14. As you can see it's a powerful, flexible, yet easy-to-use tool for implementing control logic. The next three chapters discuss the use of the VT14 (and the Industrial 14 controllers) in far greater detail. You'll learn more about the controllers' internal and external I/O structure, how to program other circuits like shift registers, retentive memories, and up/down counters, and how to use the VT14 during start-up of your Industrial 14 controlled system.

# CHAPTER 2

## WRITING YOUR CONTROL PROGRAM

This Chapter describes the Industrial 14 circuit design format so that the program can be entered via the VT14. Before writing your control program, you should have the input and output devices properly assigned to the I/O converters. You should also have a thorough knowledge of the sequence of operations of your machine.

### I/O NUMBERS

Blocks of numbers are used to identify inputs, outputs, and internal functions (Figure 2-1). These numbers are used to program the Industrial 14 and also specify the physical I/O converter to which an input or output is wired. Inputs are numbered 0 to 777, outputs are 1000 to 1377, and internal functions are numbered 1400 to 1777. These I/O numbers are not totally consecutive; only "octal" numbers are used – those which include no 8's or 9's. Thus there is neither input 008 nor output 1080. Actually there are 512 separate input points, 256 separate output points, and 256 I/O numbers for internal functions as noted in Figure 2-1. For further details on input and output assignments, refer to the *Industrial 14 Systems Manual*.

### INTERNAL I/O GROUPINGS

The 256 internal functions which use I/O numbers 1400 through 1777 are subdivided by type: retentive memories, shift registers, timers, counters, and up/down counters. This group can be easily adjusted to provide a "best fit" for each application. The normal grouping for internal I/O is shown in Figure 2-2. Individual I/O numbers from 1400 to 1577 may be used as either retentive memories or shift register bits. The I/O numbers between 1600 and 1757 are used *in pairs* to provide timers or event counters. I/O numbers beginning with 1760 are used in groups of four to provide up/down counters.

The I/O numbers from 1400 to 1577 may be used randomly for either retentive memories or shift registers. The lower I/O numbers from 1600 to 1757 must be used for timers, beginning at 1600 and consecutively up through the last timer. Counters must use I/O numbers greater than the last timer and up through 1757.

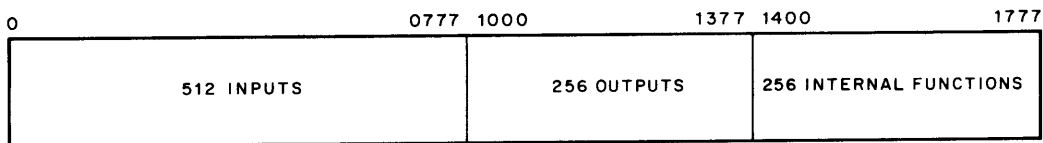

14-0207

Figure 2-1 I/O Partitioning

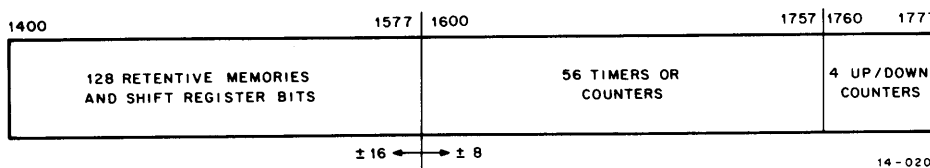

14-0206

Figure 2-2 Internal I/O Groupings

**Table 2-1**  
**Typical Assignment of Internal I/O Numbers**

| I/O Number | Use                   |                          | Comment                                       |
|------------|-----------------------|--------------------------|---|
| 1400       | Retentive Memory      | ↑                        | Random retentive memories and shift registers |
| 1401       | Retentive Memory      |                          |   |
| 1402       | Shift Register        |                          |   |
| 1403       |                       |                          |   |
| 1404       |                       |                          |   |
| .          |                       |                          |   |
| .          | Retentive Memory      |                          |   |
| 1450       |                       |                          |   |
| 1451       |                       |                          |   |
| 1452       | Retentive Memory      |                          |   |
| .          | Shift Register        | Adjustable I/O partition |   |
| 1576       |                       |                          |   |
| 1577       |                       |                          |   |
| 1600       | Timer                 | ↑                        | Timers used <i>consecutively</i>              |
| 1601       |                       |                          |   |
| 1602       | Timer                 | ↓                        |   |
| 1603       |                       |                          |   |
| .          | Timer – Spare         | ↑                        | Several timers left as spares                 |
| 1670       |                       |                          |   |
| 1671       |                       |                          |   |
| 1672       | Timer – Spare         | ↓                        |   |
| .          |                       |                          |   |
| 1676       | Timer – Spare         | ↑                        |   |
| 1677       |                       |                          |   |
| 1700       | Counter               | ↑                        | Event counters                                |
| 1701       |                       |                          |   |
| 1702       | Counter               | ↓                        |   |
| 1703       |                       |                          |   |
| .          | Counter               | ↑                        | Up/Down counters                              |
| 1756       |                       |                          |   |
| 1757       |                       |                          |   |
| 1760       | Four Up/Down Counters | ↓                        |   |
| .          |                       |                          |   |
| .          |                       |                          |   |
| 1777       |                       |                          |   |

A typical assignment of internal functions using 1600 as the I/O partition is given in Table 2-1. Note that:

1. All retentive memories and shift register bits use one I/O number.
2. All timers and counters use two I/O numbers.
3. The bits of a shift register must be consecutive; however, the shift registers and retentive memories may be intermixed.
4. Timers must start at the I/O partition (in this case, 1600). They must be totally consecutive using I/O numbers below any counter circuit. (For this reason, a few spare timers were allowed for.)
5. Four up/down counters are permanently provided for in the Industrial 14.

#### ADJUSTING THE INTERNAL I/O GROUPING

While the grouping of internal functions (Figure 2-2 and Table 2-1) is suitable for many applications, it may be necessary to modify this grouping in certain applications. This is possible by adjusting switches within the Industrial 14 Control Unit. This procedure is described in the *Industrial 14 Systems Manual*.

The modification to achieve more (or fewer) retentive memories and shift register bits, can be made by sacrificing (or obtaining more) timers and counters. This corresponds to moving the starting point of the timer circuits from 1600 to some other I/O partition. However, since two I/O numbers are used for a timer or counter, while only one is required for a retentive memory, the gain (or loss) of retentive memories is always double the loss (or gain) of timers and counters.

The internal I/O groupings that can be achieved are listed in Table 2-2. Quantities of timers and counters are gained or lost in multiples of 8 by sacrificing or increasing retentive memories and shift register bits in multiples of 16.

The normal setting, indicated in Table 2-2 is assumed throughout this manual.

#### OUTPUT CIRCUITS

Devices such as motor starters, solenoids, etc., are driven by I/O numbers 1000–1377 according to output circuits comprised of contacts for inputs, outputs, and internal functions.

Inputs (i.e., limit switches, pushbuttons) are assumed to be wired to the 14 using normally-open contacts. The driven output (set on if the circuit solves) is located in the upper right of the circuit. The circuit itself is a 10 X 8 grid of elements (contacts and branches). Figure 2-3 is a form which can be used to construct your circuit. (It is reproduced in Appendix D.) Each box can contain a branch, a contact, or a line continuation to space branches properly.

Using the format of Figure 2-3 you must observe several rules illustrated in Figure 2-4 by showing improper circuits and their acceptable equivalents.

**Table 2-2**  
Possible Internal Function Groupings

| Quantity of                                     |                          |                     |   |
|---|--------------------------|---------------------|---|
| Retentive Memories<br>or<br>Shift Register Bits | Timers<br>or<br>Counters | Up/Down<br>Counters | I/O Partition<br>(First Timer<br>Circuit) |
| 0   | 120                      | 4                   | 1400                                      |
| 16  | 112                      | 4                   | 1420                                      |
| 32  | 104                      | 4                   | 1440                                      |
| 48  | 96                       | 4                   | 1460                                      |
| 64  | 88                       | 4                   | 1500                                      |
| 80  | 80                       | 4                   | 1520                                      |
| 96  | 72                       | 4                   | 1540                                      |
| 112   | 64                       | 4                   | 1560                                      |
| 128*  | 56                       | 4                   | 1600                                      |
| 144   | 48                       | 4                   | 1620                                      |
| 160   | 40                       | 4                   | 1640                                      |
| 176   | 32                       | 4                   | 1660                                      |
| 192   | 24                       | 4                   | 1700                                      |
| 208   | 16                       | 4                   | 1720                                      |
| 224   | 8                        | 4                   | 1740                                      |
| 240   | 0                        | 4                   | 1760                                      |

\*Normal grouping as shipped by Digital Equipment Corporation.

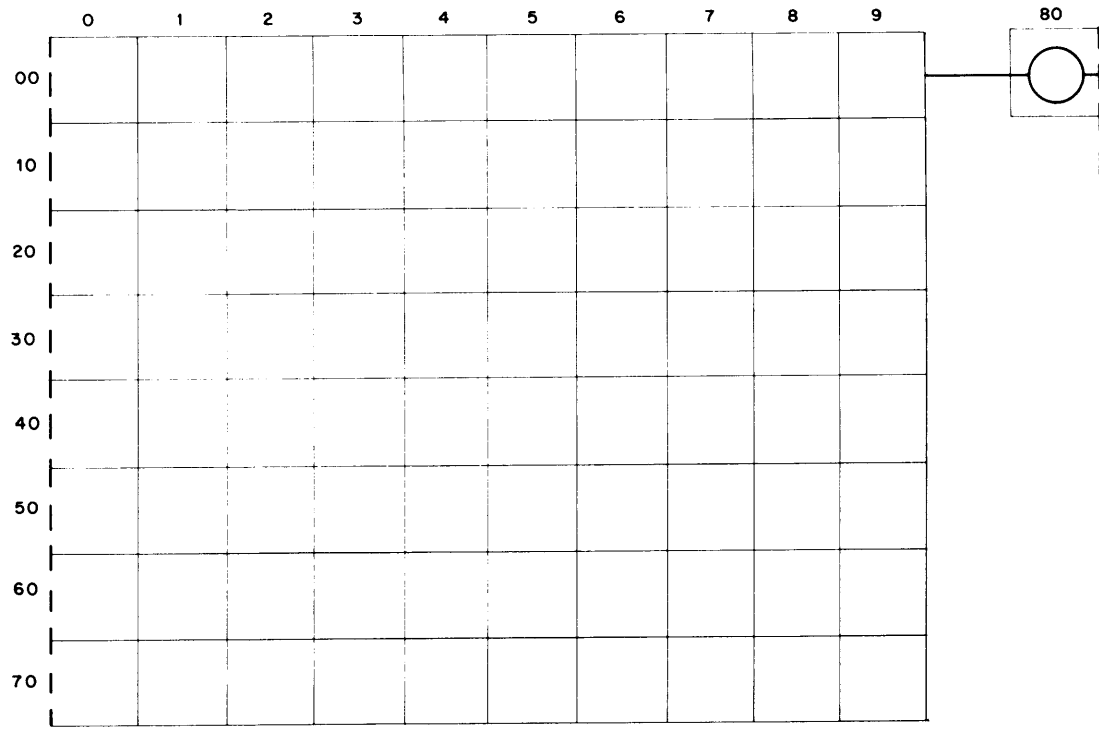
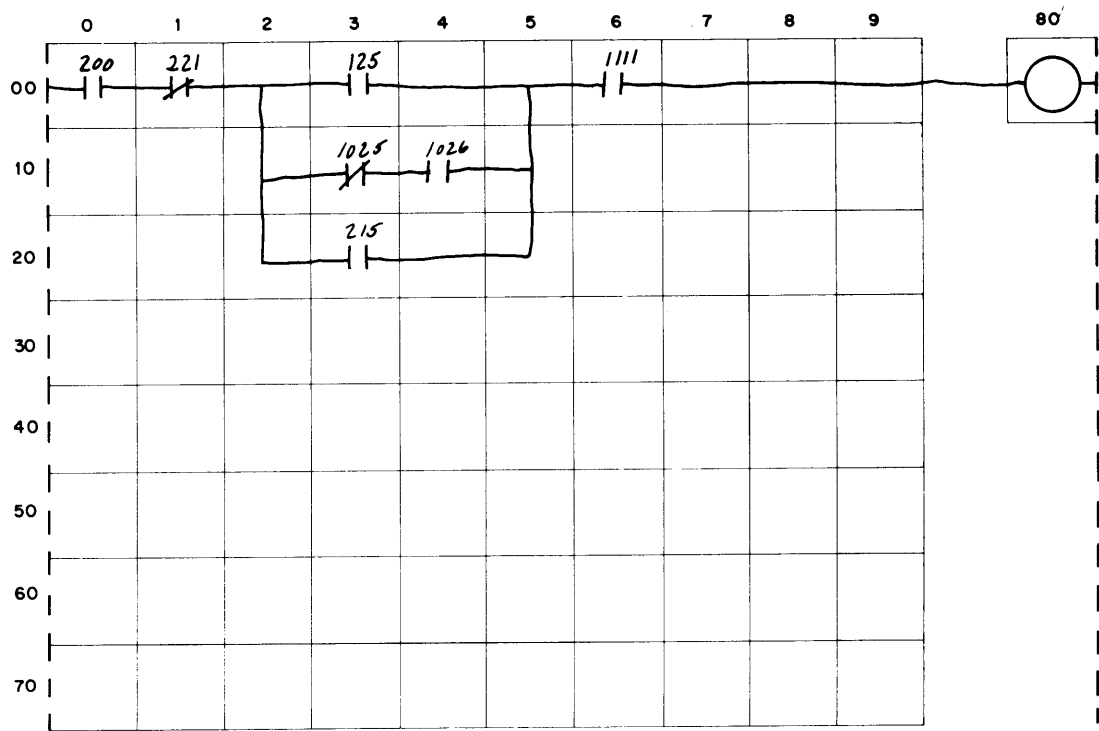

14-0205

Figure 2-3 Industrial 14 Circuit Format



| IMPROPER CIRCUIT | ACCEPTABLE EQUIVALENT |
|------------------|-----------------------|
|                  |                       |
|                  |                       |
|                  |                       |
|                  |                       |
|                  |                       |
|                  |                       |

14-0213

Figure 2-4 VT14 Circuit Rules

### RETENTIVE MEMORIES

Retentive memory circuits replace latching relays to record operations or status if a power failure occurs. All outputs (having I/O numbers 1000 to 1377) are cleared when the Industrial 14 loses power. Retentive memory outputs having I/O numbers from 1400 to 1577, however, are not cleared and will retain their previous state when the 14 is powered up.

The retentive memory circuit in Figure 2-5 records the full depth state of a drill-head or probe and the second circuit retracts the head or probe upon reaching the full depth position.

#### NOTE

**A retentive memory may be programmed to clear in the event of a power shut-down. Refer to "Non-Retentive Internal Functions" later in this Chapter.**

### SHIFT REGISTERS

The Industrial 14 allows any consecutive group of external outputs (I/O numbers 1000–1377) or internal functions (normally I/O numbers 1400–1577) to be used as a shift register. When external outputs are used, the shift register will be cleared whenever the 14 is shut-down. When internal functions are used, the shift register will hold its state during a 14 shut-down. (Internal I/O numbers may also be used for a non-retentive shift register. Refer to "Non-Retentive Internal Functions" later in this Chapter.)

The Shift Circuit transfers the data from each location to the next higher location (higher in terms of I/O numbers). The shift occurs when the coil of the shift circuit is first energized. The shift circuit remains energized as long as its circuit conditions are met; the next shift occurs when the coil has been de-energized, then re-energized.

The shift register bits can be formed from a series of retentive memories or unused outputs, but they must be a consecutive group. Since the shift register is comprised of individual I/O numbers, a circuit may be designed to parallel load into any position of the shift register.

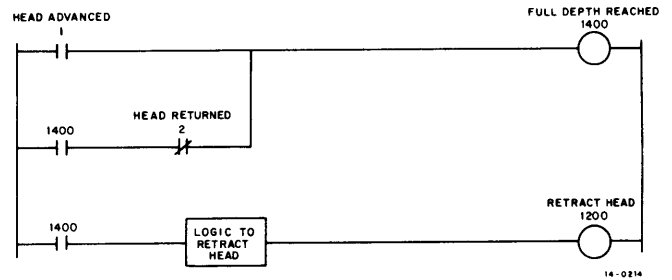

Figure 2-5 Retentive Memory Circuit to Record Full-Depth Reached

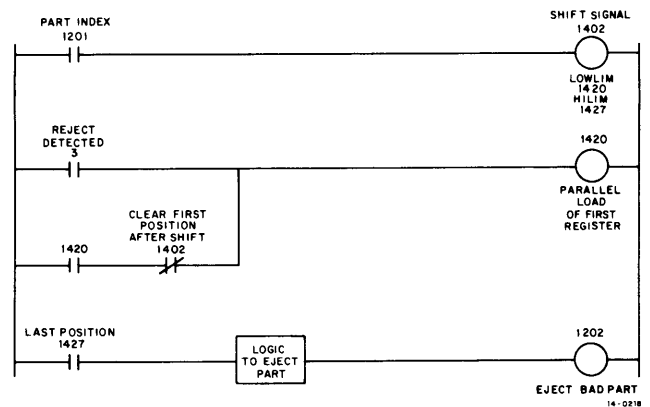

Figure 2-6 Shift Register Circuit to Track a Reject Part

Shift registers are useful for numerous applications. One is for identifying parts in a manufacturing transfer operation, either for acceptance testing or for performing an additional operation. As each part is transferred to a new station, a corresponding register bit is shifted. Figure 2-6 shows three circuits that keep track of parts moving through eight stations and finally reject the part if it is bad. The first circuit is the shift circuit, the second loads the reject status into the first bit in the shift register, and the third rejects the bad part based on the state of the last bit in the shift register.

The circuit for 1420 in the previous example illustrates the general form for a shift register parallel load circuit shown in Figure 2-7. If the application had called for a cancel signal to clear the shift register bit, it would have appeared in series with the output.

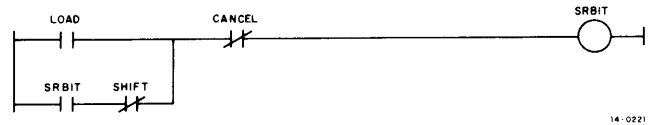

Figure 2-7 General SR Parallel Load Circuit

The amount of controller memory required to store a shift register includes the memory locations needed to store the shift circuit plus the locations needed to move each bit of the shift register (Figure 2-8). The total amount of memory for a shift register is limited to 256 locations. Thus, the smaller the shift circuit, the more bits the shift register can include and vice versa. The smallest shift circuit allows approximately 81 shift register bits – the largest shift circuit allows approximately 56 shift register bits. If the combination of the shift circuit plus the instructions to move each bit is too great, it will be detected when the circuit is stored via the VT14. If this should occur, simply break the shift register into two separate segments. For example, two shift register circuits must be used to shift 120 bits. One circuit might shift the first 40 consecutive bits. The other senses the output coil of the first circuit and then shifts the last 81 consecutive bits (a total of 120 bits plus 1 bit to link the two shift registers). Figure 2-9 illustrates this.

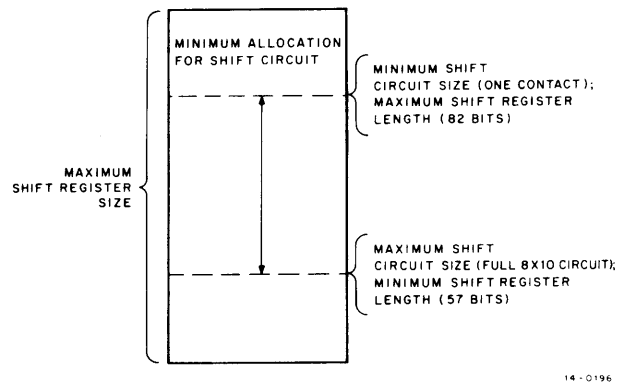

Figure 2-8 Industrial 14 Memory Allocation for Shift Registers

### TIMERS

Industrial 14 timer circuits use two I/O numbers each, usually in the range 1600–1757 (refer to I/O numbers, this Chapter). The timer circuit is programmed using the first, or even numbered, I/O number. When this I/O number (e.g. 1600) is energized, the timer starts; when it is de-energized the timer clears, regardless of whether the full time interval has elapsed.

The contact for the even I/O number (e.g. 1600) senses the instantaneous state of the timer. The contact for the odd I/O number (e.g. 1601) senses the delayed timed-out state. The states of these two contacts are shown in Figure 2-10. Notice the results when the timer circuit is de-energized prior to completing the full delay.

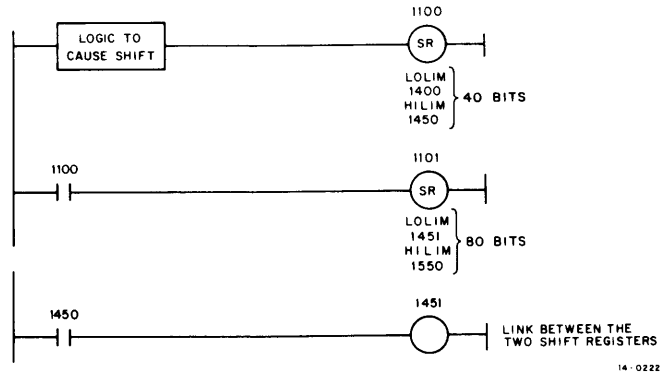

Figure 2-9 Linking Two Shift Registers

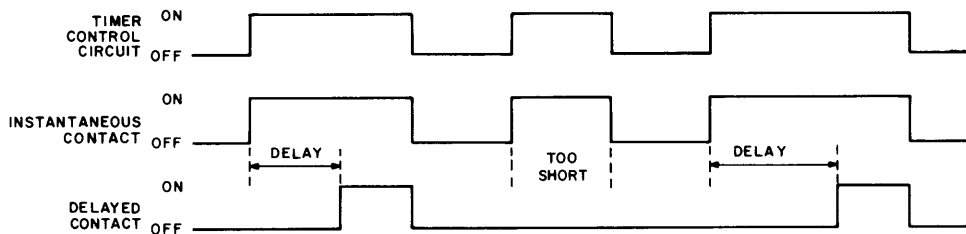

Figure 2-10 Timing Circuit Operation

A timer can be used in conjunction with external outputs to delay the turn-on of power devices such as solenoids or motor starters. Figure 2-11a is a timing diagram of such a timer circuit. Notice that an input condition starts the timer and the timed-out state turns on output 1000. Figure 2-11b is a ladder diagram of the circuit.

Occasionally it is useful to sense the instantaneous contact (even number) of a timer in a lock-up (latch) circuit to turn on an external output at a given time after an input condition is sensed. An example is a package on a conveyor that passes a photoswitch and moves on to an elevator. There must be a time delay between the photoswitch detecting the package and the elevator starting to move. The instantaneous contact keeps the timer coil energized even though the input is no longer present. Figure 2-12a is a timing diagram and Figure 2-12b is a ladder diagram of such a situation.

Timers are also used in applications to extend the on time of an output (Figure 2-13) or to set an output on for a given time after de-energizing an input (Figure 2-14).

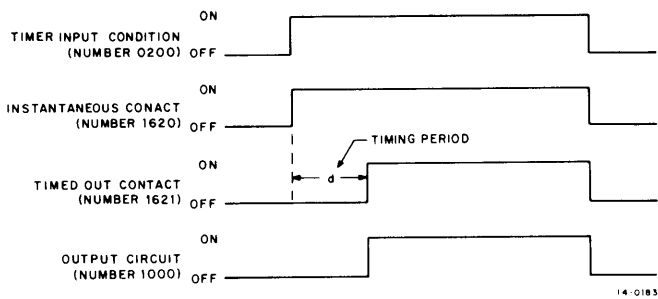

Figure 2-11a Timing Diagram

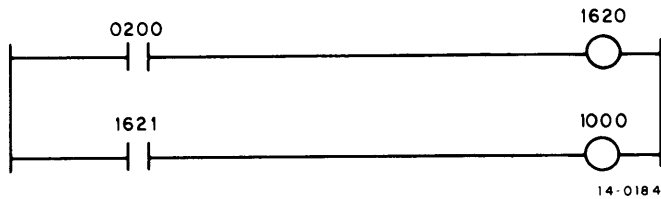

Figure 2-11b On-Delay Timer Circuit

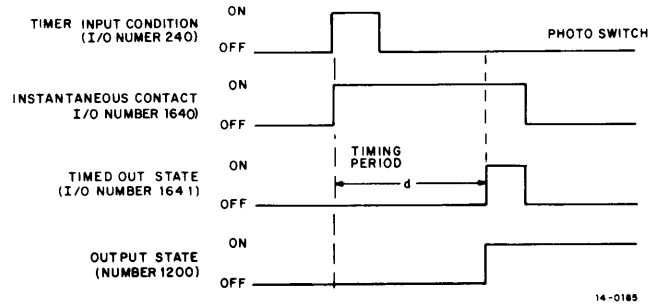

Figure 2-12a Timer Lock-Up Circuit

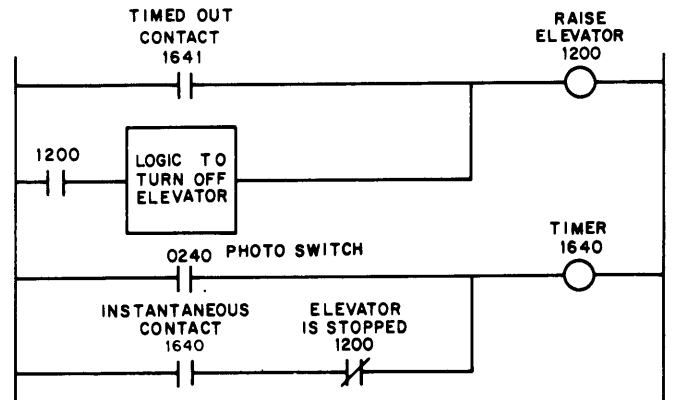

Figure 2-12b Timer Lock-Up Circuit

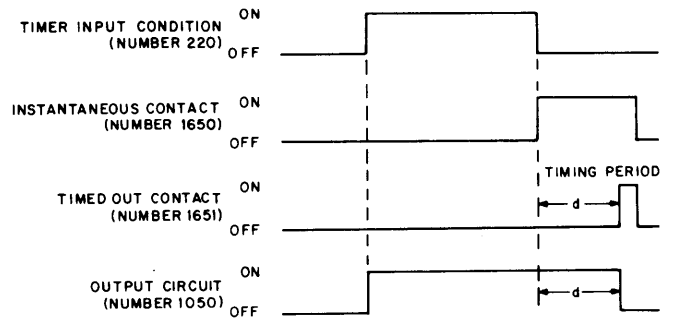

Figure 2-13a Off-Delay Timer Circuit

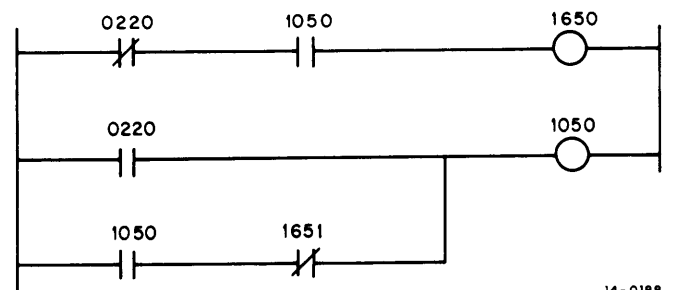

Figure 2-13b Off-Delay Timer Circuit

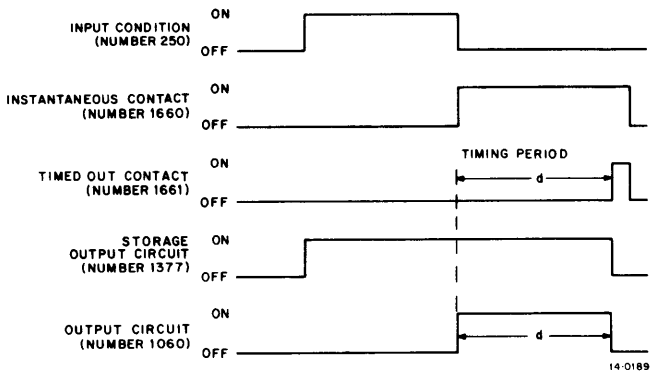

Figure 2-14a Circuit to Energize an Output for a Fixed Interval After De-Energization of an Input

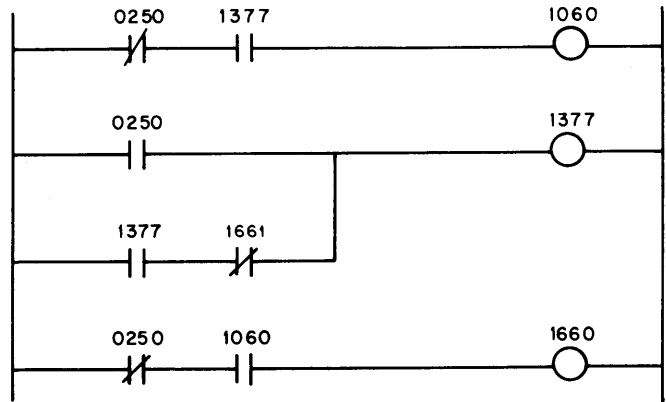

Figure 2-14b Circuit to Energize an Output for a Fixed Interval After De-Energization of an Input

**EVENT COUNTERS**

Event counters (up count only) share I/O numbers 1600–1757 with timer circuits; however, each counter must use a higher I/O number than any timer circuits. Two control circuits with consecutive numbers are required for an event counter: The even numbered circuit increments the counter when set on and an odd numbered circuit clears the counter when energized. Increments that occur while the clear circuit is on have no effect on the counter.

The odd numbered contact of the up counter senses whether or not the count equals or exceeds the preset count. This sensed contact can be used in parallel or series with other contacts within control circuits.

Figure 2-15 is an example of an up counter to shut down a station after three successive bad parts. Notice that the normally closed contact 1701 senses whether the number of parts are less than three and stops the station operation if the count is three or more.

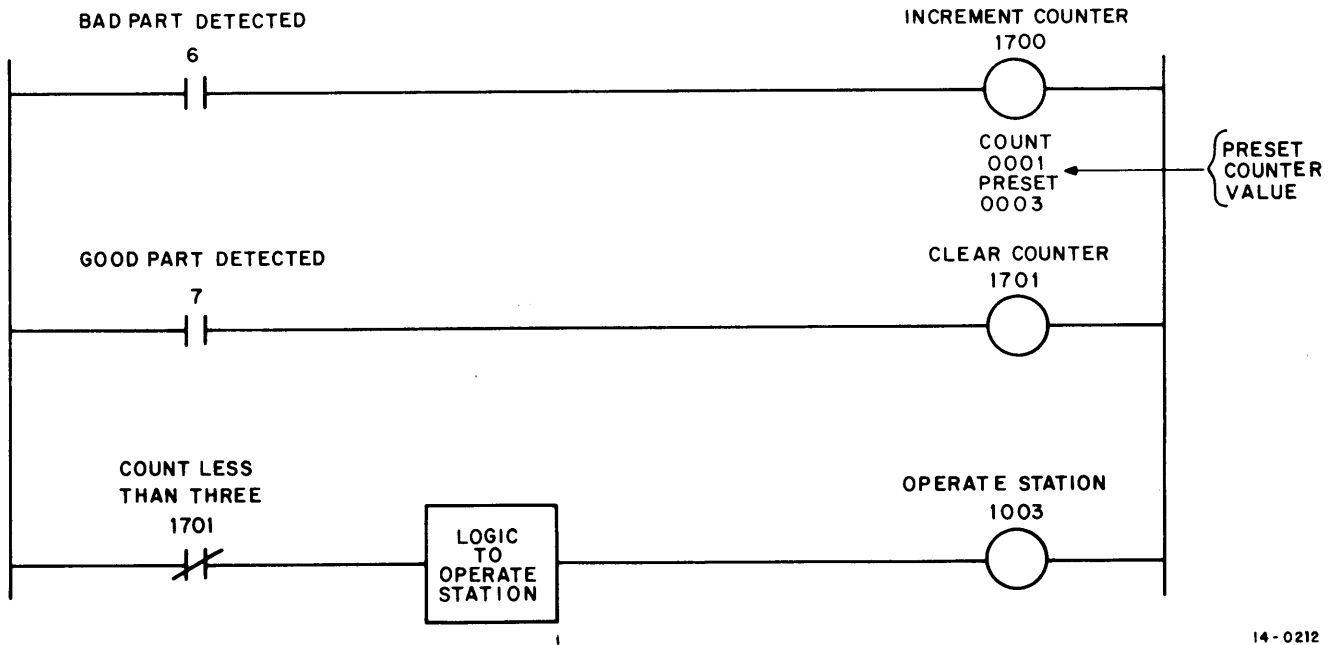

Figure 2-15 Event Counter Circuit to Shut Down a Station After Three Successive Bad Parts

### UP/DOWN COUNTERS

The Industrial 14's selection of internal functions always includes four up/down counters. These counters are permanently assigned to the I/O numbers given in Table 2-3. They are programmed using three I/O numbers: The first to increment, the second to clear, and the third to decrement the counter. The fourth I/O number is not used and is not available for use.

Contacts for the first I/O number (1760, 1764, 1770, and 1774) are used in other control circuits to indicate that the preset value has been reached or exceeded. (The up/down counter will continue to increment even after its preset value has been reached.) Contacts for the second I/O number (1761, 1765, 1771, and 1775) are used to test for a zero counter value.

A typical up/down counter application limits parts on a conveyor. In Figure 2-16, the contact 1760 senses whether there are six parts in a particular conveyor zone. If there are six parts on the conveyor, a gate is activated to prevent parts from entering.

Table 2-3  
Up/Down Counters

| Counter | I/O Number | Function               |                   |
|---------|------------|------------------------|-------------------|
|         |            | As an Output           | As a Contact      |
| 1       | 1760       | Count Up               | $\geq$ Preset     |
|         | 1761       | Clear                  | = 0               |
|         | 1762       | Count Down             | N/A               |
|         | 1763       | Do Not Use             | N/A               |
| 2       | 1764       | Count Up               | $\geq$ Preset     |
|         | 1765       | Clear                  | = 0               |
|         | 1766       | Count Down             | N/A               |
|         | 1767       | Do Not Use             | N/A               |
| 3       | 1770       | Count Up               | $\geq$ Preset     |
|         | 1771       | Clear                  | = 0               |
|         | 1772       | Count Down             | N/A               |
|         | 1773       | Do Not Use             | N/A               |
| 4       | 1774       | Count Up               | $\geq$ Preset     |
|         | 1775       | Clear                  | = 0               |
|         | 1776       | Count Down             | N/A               |
|         | 1777       | Not used<br>in counter | <u>INITIALIZE</u> |

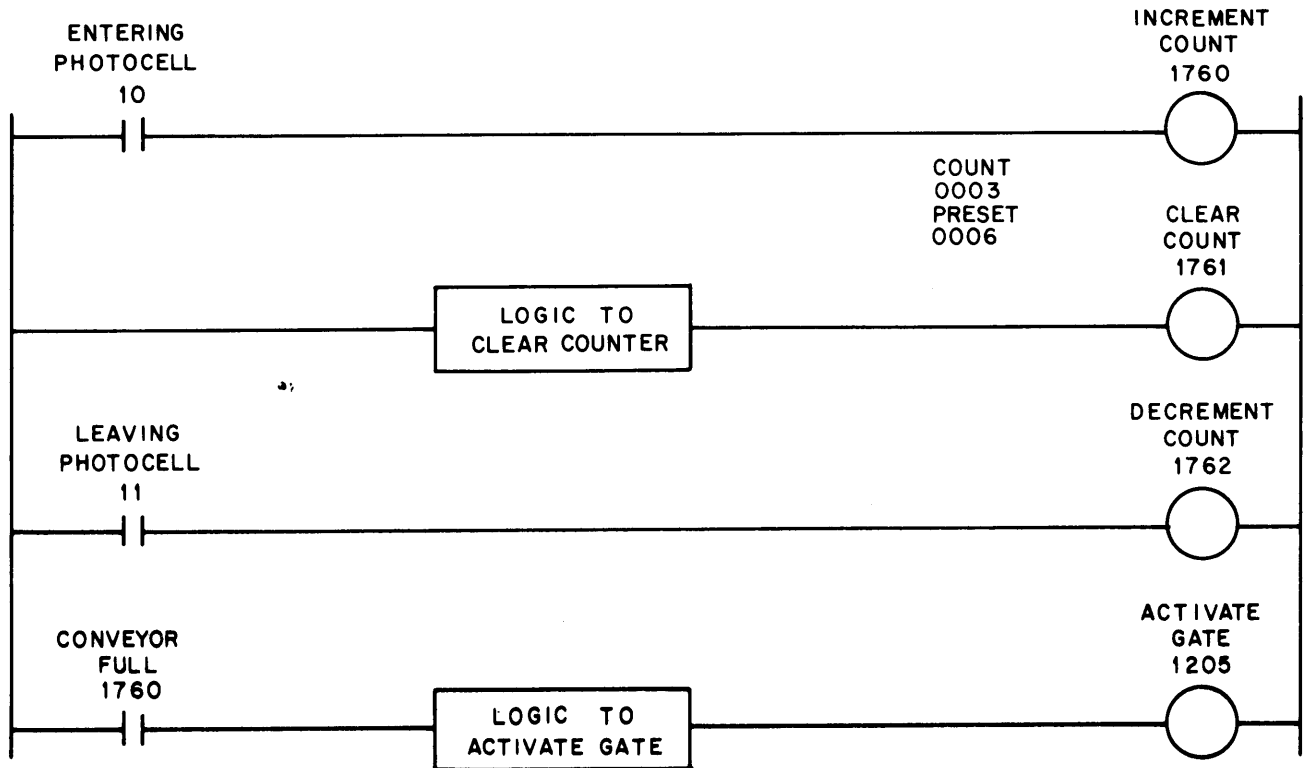

14-0233

Figure 2-16 Up/Down Counter Circuit to Limit Parts on a Conveyor to a Maximum of Six

**NON-RETENTIVE INTERNAL FUNCTIONS**

While all external output circuits turn off if the 14 loses power, all internal functions normally retain their current state or value during and after a power failure. This means that a timer, interrupted part-way through its interval by a shut-down of the 14, will continue (not reset) when power returns. The Industrial 14, however, has an I/O number (1777) that acts as a system initialize signal to reset timing or to initiate some special action when a 14 is first powered

up. This contact, called *not initialize*, (INITIALIZE) is off after a power shut-down for the first pass through 14 controller memory. It is on thereafter. If a pneumatic-type timer is desired, i.e., one that resets with a power failure, the normally-open, not-initialize (1777) should be programmed in series with the control circuit (Figure 2-17).

To make a shift register non-retentive, a circuit must be entered for each bit (Figure 2-18).

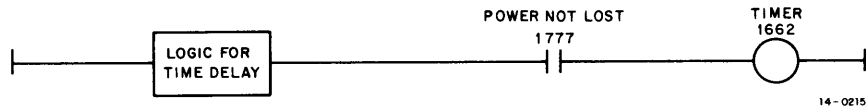

Figure 2-17 Clear Timer if Power is Lost





Figure 2-18 Circuit to Clear One Bit of a Shift Register on Power Failure

**CIRCUITS CONTAINING INPUTS THAT ARE WIRED NORMALLY-CLOSED**

Usually, input devices are wired to the Industrial 14 Controller using a normally-open contact. However, in some instances it may be desirable to use a normally-closed contact for safety, fail-safe, or other considerations. The use of a normally-closed contact has the effect of reversing the sense of the input signal as described below.

The Industrial 14 Controller has no way of determining the physical position of a switch or pushbutton – only the electrical condition of an input terminal.



When a  symbol is used within a control circuit, the Industrial 14 tests for the presence of field voltage at the appropriate input converter. Similarly, when a  symbol is used, the 14 tests for the absence of field voltage.

When the input is wired to the controller using a normally-open contact, the electrical and mechanical states are consistent – an on input means a tripped switch, an off input means an un-tripped switch.

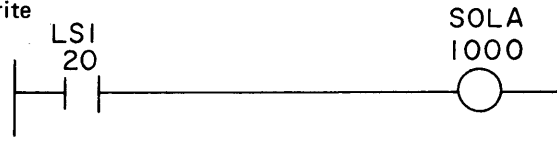
Thus, when you design a control circuit for the 14 and you write







you may be thinking, "Turn on output 1000 (SOLA) when Switch 20 (LS1) is tripped." But you are really saying, "When voltage is present at input terminal 20, turn on the output."

However, if you use a normally-closed input contact, the sense of the input is reversed. When the switch is *not* tripped, voltage is present at the input terminal. Therefore, the  symbol means switch not tripped. Likewise, the  symbol means no voltage present and therefore switch-tripped. Table 2-4 summarizes the meaning of the contact symbols used within a control circuit arising from inputs being wired N/O or N/C.

As a further illustration of the difference between using N/O and N/C contacts, refer to the simple start/stop circuit of Figure 2-19.

Part A shows the relay circuit; Part B shows the Industrial 14 control circuit with both pushbuttons wired N/O; and Part C shows the use of a N/C contact as the stop pushbutton.

**Table 2-4**  
**Meaning of Circuit Symbols and Wiring Conditions**

|                    | Use This Contact  | Test This Condition  |
|--------------------|---|----------------------|
| Input is Wired N/O |  | Switch Activated     |
|                    |  | Switch Not Activated |
| Input is Wired N/C |  | Switch Not Activated |
|                    |  | Switch Activated     |

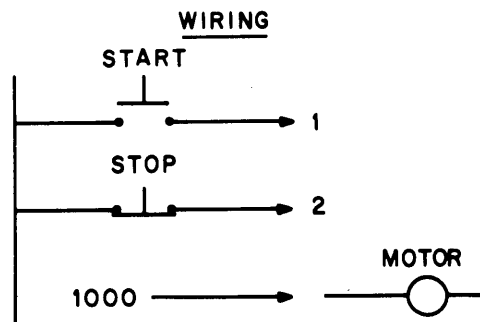
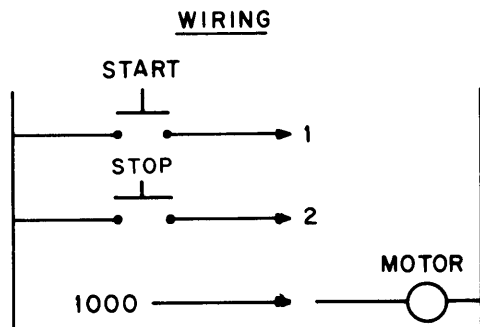
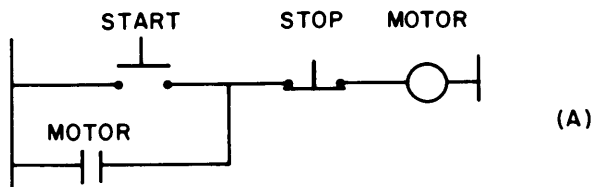

14-C225

Figure 2-19 Start/Stop Circuit with N/O and N/C Contacts



## CHAPTER 3

### ENTERING THE PROGRAM

After designing all circuits to control your machine or process, you are ready to enter your program into the VT14. This chapter details the VT14 entry and editing capabilities. You will find the VT14 keyboard and display easy to use for entering, changing, and verifying your control logic.

#### CLEARING 14 MEMORY

Before entering a new program, the Industrial 14 controller's memory should be cleared in the following way:

1. Insert the VT14 key in the mode switch.
2. Turn the key to CLEAR MEMORY position and hold it there.
3. While holding the key in this position, press the ERASE switch and then release the key.
4. The VT14 screen will show DONE when memory is clear. (Allow approximately one minute for this to occur.)

#### ENTERING A CIRCUIT

A circuit is entered from left to right, top to bottom. The first horizontal line of a ladder diagram must be complete

before the next line is started. As each element is entered, the display should be visually checked to see that the last entry properly aligns with the preceding one. An incomplete diagram, or one with disjointed branches (branches that do not connect), will not store.

Figure 3-1 is an example of a ladder diagram and Table 3-1 is a step-by-step procedure for entering that diagram into the VT14 Terminal. Notice that the symbols shown in the figure are drawn as they normally appear on engineering drawings. Those in the table are drawn as they are displayed by the VT14.

In Step 1 of the table, notice that the first symbol in the ELEMENT column is a pushbutton contact with assigned I/O number 0245. It is entered by setting the I/O NUMBER switches to 0245 and pressing the normally-open contact switch (—|—). The display, which occurs automatically, is depicted in the DISPLAY column of Table 3-1. In Step 2, the line switch (●—●) is pressed and the result is indicated by the DISPLAY column. Similarly perform each of the steps in Table 3-1 to enter the ladder diagram. A cursor will indicate the screen position to which the circuit is complete as each step is performed.

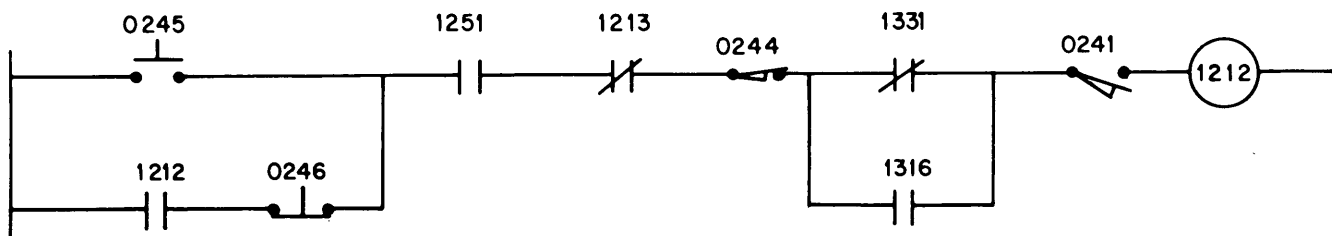

14-0171

Figure 3-1 Sample Control Circuit

**Table 3-1**  
**Step-by-Step Circuit Entry Procedure**

| STEP | ELEMENT  | ENTRY SWITCHES | DISPLAY                                |
|------|----------|----------------|--|
| 1    | 0245<br> | 0 2 4 5<br>    | 0245<br>                               |
| 2    | —        |                | 0245<br>                               |
| 3    | T        |                | 0245<br>                               |
| 4    | 1251<br> | 1 2 5 1<br>    | 0245 1251<br>                          |
| 5    | 1213<br> | 1 2 1 3<br>    | 0245 1251 1213<br>                     |
| 6    | 0244<br> | 0 2 4 4<br>    | 0245 1251 1213 0244<br>                |
| 7    | T        |                | 0245 1251 1213 0244<br>                |
| 8    | 1331<br> | 1 3 3 1<br>    | 0245 1251 1213 0244 1331<br>           |
| 9    | T        |                | 0245 1251 1213 0244 1331<br>           |
| 10   | 0241<br> | 0 2 4 1<br>    | 0245 1251 1213 0244 1331 0241<br>      |
| 11   | 1212<br> | 1 2 1 2<br>    | 0245 1251 1213 0244 1331 0241 1212<br> |
| 12   | T        |                | 0245 1251 1213 0244 1331 0241 1212<br> |
| 13   | 1212<br> | 1 2 1 2<br>    | 0245 1251 1213 0244 1331 0241 1212<br> |

**Table 3-1 (Cont)**  
**Step-by-Step Circuit Entry Procedure**

| STEP | ELEMENT  | ENTRY SWITCHES | DISPLAY |
|------|----------|----------------|---------|
| 14   | 0246<br> | 0 2 4 6<br>    |         |
| 15   |          |                |         |
| 16   |          | SPACE<br>      |         |
| 17   |          | SPACE<br>      |         |
| 18   |          | SPACE<br>      |         |
| 19   |          |                |         |
| 20   | 1316<br> | 1 3 1 6<br>    |         |
| 21   |          |                |         |

14-0173

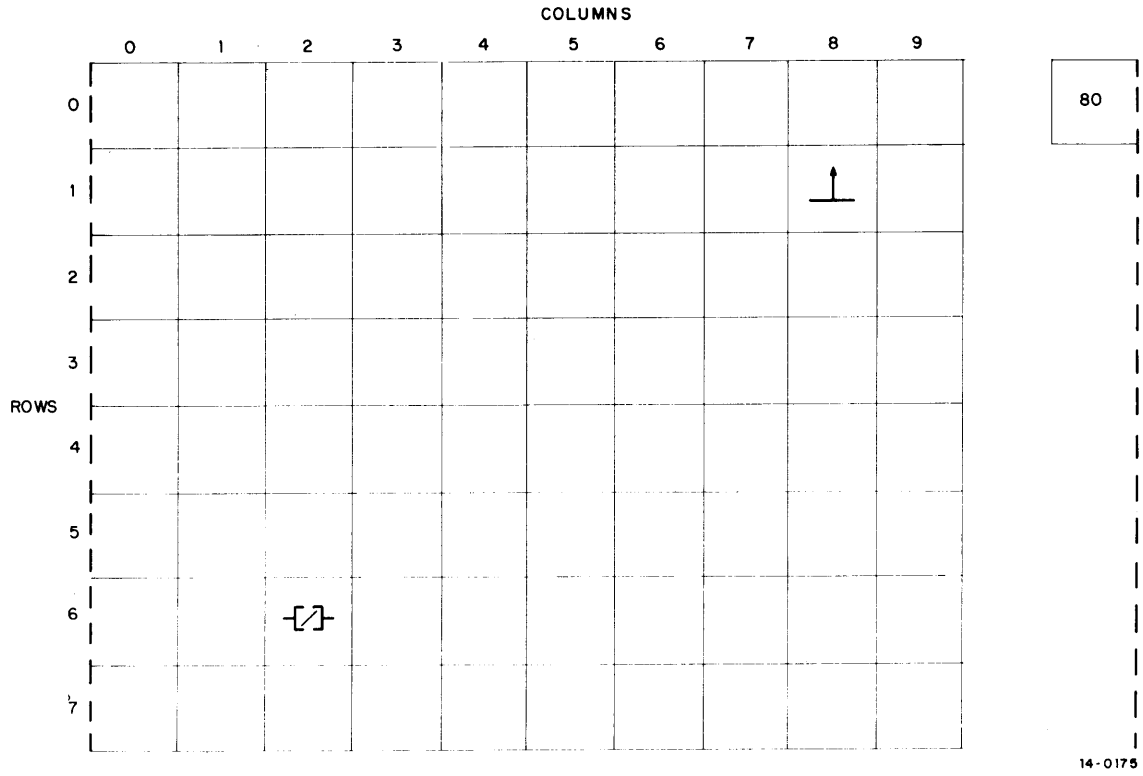

Figure 3-2 VT14 Display Positions

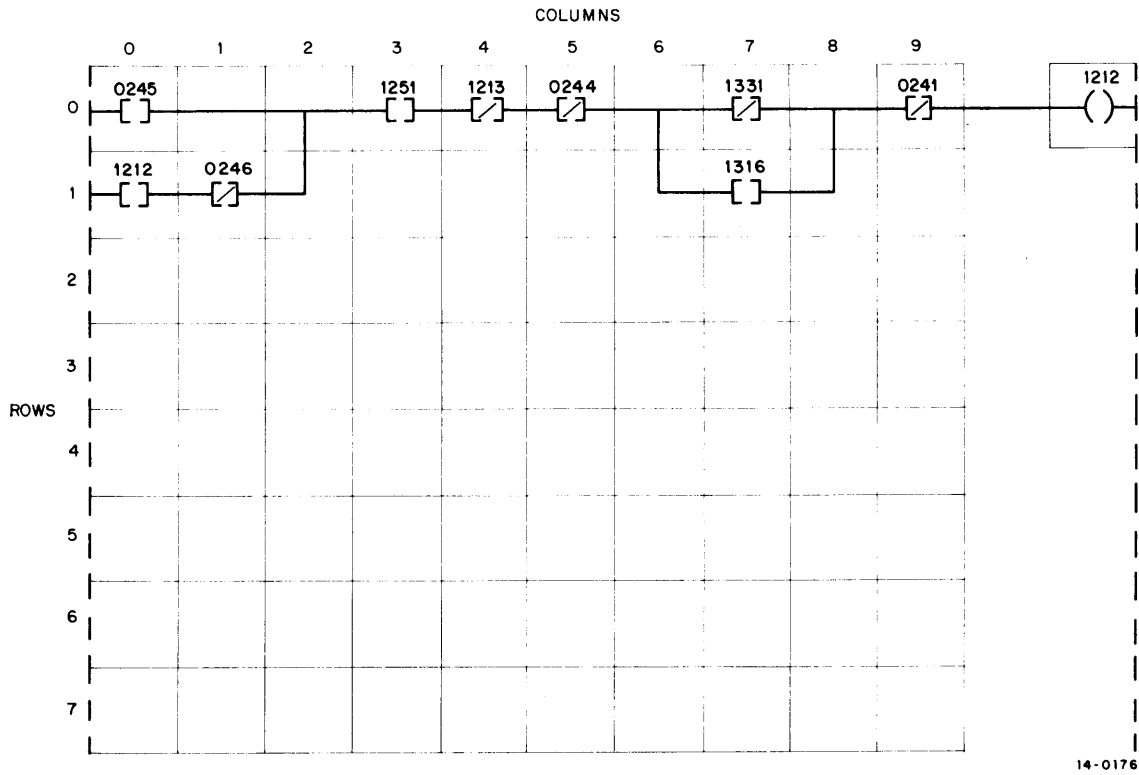

Figure 3-3 Sample Circuit Showing Grid Positions

## STORING CIRCUITS

The circuit displayed on the VT14 screen can be stored in the 14's memory by pressing the STORE key. Only one circuit for each output is stored in memory. When this key is pressed, the VT14 automatically searches memory for the output number of the circuit being stored. Any circuit found for that I/O number is erased. As soon as the new circuit is stored (allow approximately 20 seconds) a DONE message is displayed.

If there is no room in memory to store a circuit, a NO ROOM error message is displayed. If an attempt is made to store an incomplete circuit, or one with disjointed branches (lines that do not connect), a FORMAT ERROR message is displayed.

## EDITING CIRCUITS

Editing is done with the VT14 on a single position basis. That is, any element within the circuit may be replaced by another element by using position numbers without re-entering the whole circuit.

The screen is a 10 X 8 in. position grid with horizontal rows numbered 0 to 7 and vertical columns numbered 0 to 9 (Figure 3-2). Each position within the grid is denoted by a two-digit number where the first digit is the row number and the second is the column number. Each element entered occupies one position in the grid except the next line (→) symbol, which is not counted as a position. For example, the up branch symbol in Figure 3-2 is in Row 1, Column 8, which is Position 18; the normally-closed contact symbol is in Row 6, Column 2, which is Position 62. The set output is always in the upper right corner of the display, arbitrarily called Position 80.

Two examples of editing the circuit shown in Figure 3-3 are illustrated in Figures 3-4 (Example 1) and 3-5 (Example 2).

Example 1: Change the normally-open (—|—) contact 1316 shown in position 17 of Figure 3-3 to a normally-closed contact (—|/—) 1316.

1. Set the PRESET or POSITION switches to 17.
2. Press the EDIT key. (Notice that the cursor appears below and to the left of the element to be changed.)
3. Set the I/O NUMBER switches to the I/O address for the normally-closed contact (1316).
4. Press the normally-closed contact (—|/—) key.

Example 2: Change the normally-open contact (1251) from position 03 to position 01.

1. Set the PRESET or POSITION switches to 03.
2. Press the EDIT key. (Again notice the cursor.)
3. Press the line (●—●) key.
4. Set the PRESET or POSITION switches to 01.
5. Press the EDIT key.
6. Set the I/O NUMBER switches to 1251.
7. Press the normally-open contact (—|—) key.

After each editing operation, the cursor will step to the next grid position allowing you to correct several consecutive positions within a circuit. Once a circuit seems correct, then it should be stored into 14 memory by pressing the STORE key.

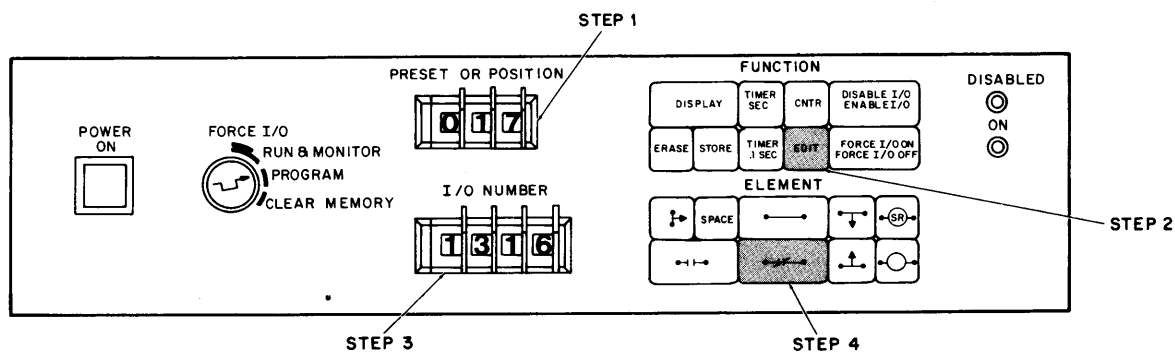

14-0177

Figure 3-4 Procedure for Changing a Normally-Open Contact to a Normally-Closed Contact

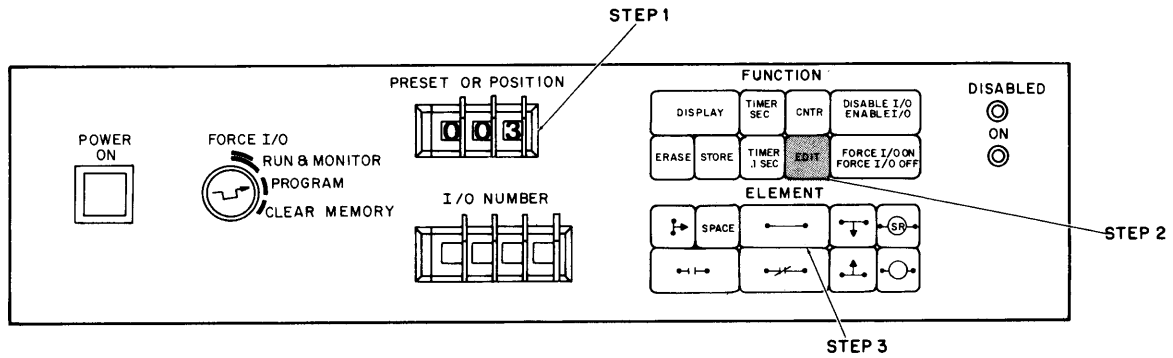

14-0178

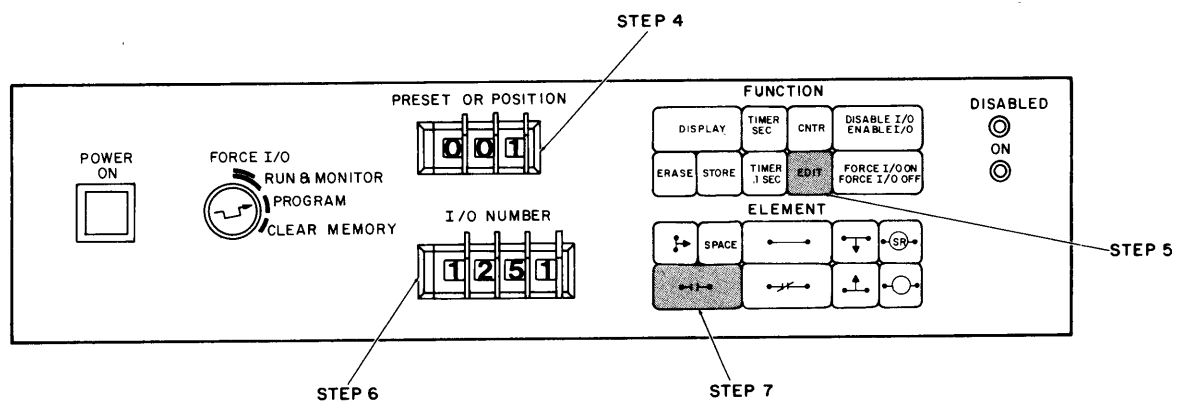

14-0179

Figure 3-5 Procedure for Changing the Position of an Element

### REMOVING A CIRCUIT FROM MEMORY

Circuits can be individually removed from 14 memory whenever necessary by the following procedure:

1. Set I/O NUMBER switches to the output number of the circuit to be removed.
2. Turn the MODE switch to the CLEAR MEMORY position and hold it there.
3. While holding the MODE switch in this position, press the set output (  $\text{---}\text{O}\text{---}$  ) key. Then return the mode switch to program mode.
4. The display will print DONE indicating that the circuit has been removed.

This procedure is used to remove an output circuit that has been programmed. It is *not* necessary to remove a circuit prior to editing it. Whenever a new circuit is stored, any already-stored circuit for that output will be removed.

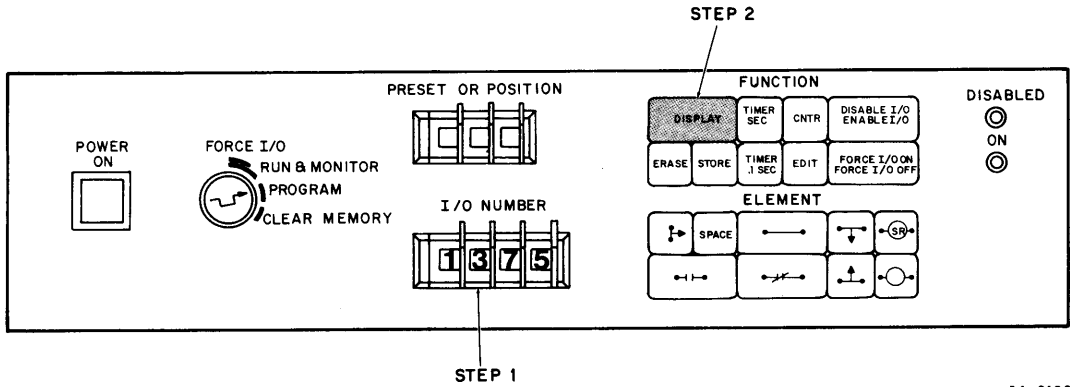

Figure 3-6 Procedure to Display a Circuit

**DISPLAYING A CIRCUIT**

An output circuit is displayed to change an element in the circuit or to monitor the circuit in the RUN & MONITOR mode. To display an output circuit, perform the procedure depicted by Figure 3-6. If the circuit to be displayed is not in memory, the NONE message is displayed. Allow approximately ten seconds for the VT14 to completely search the 14's memory.

**ENTERING A SHIFT CIRCUIT**

A shift circuit is entered like any output circuit, except the user must press the shift register (SR) key instead of the set output (O) key, and also must specify the I/O number limits for his shift register. Below is a step-by-step procedure and an example circuit (Figure 3-7) as viewed on the display:

1. Enter the shift circuit contacts and branches (contacts 1300 and 0205, for example).
2. Set the I/O NUMBER switches to the shift circuit output number (1500, for example).
3. Press the shift register (SR) key.
4. Set the I/O NUMBER switches to the lower

limit of the data to be shifted (1501, for example).

5. Press the output (O) key. The displayed LOWLIM is now the same number to which the I/O NUMBER switches were set in Step 4.
6. Set the I/O NUMBER switches to the high limit of the data to be shifted (1520, for example).
7. Again, press the output (O) key. The displayed high-limit is now the same number to which the I/O NUMBER switches were set in Step 6.
8. Complete any further lines in the shift circuit (for example, input 206).

If an attempt is made to store a shift circuit and shift registers that are too large, a TOO BIG error message will be displayed.

To alter the limits of a shift register without changing the shift circuit itself, simply EDIT Position 80 and repeat Steps 2 through 7 above.

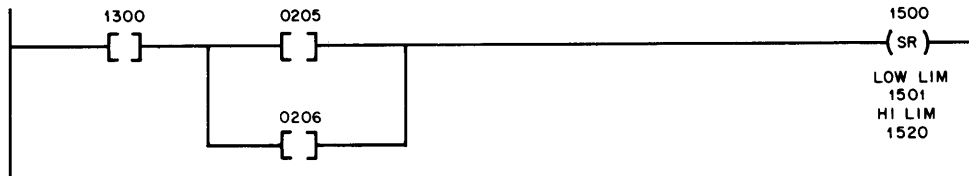

Figure 3-7 A Typical Shift Register Control Circuit

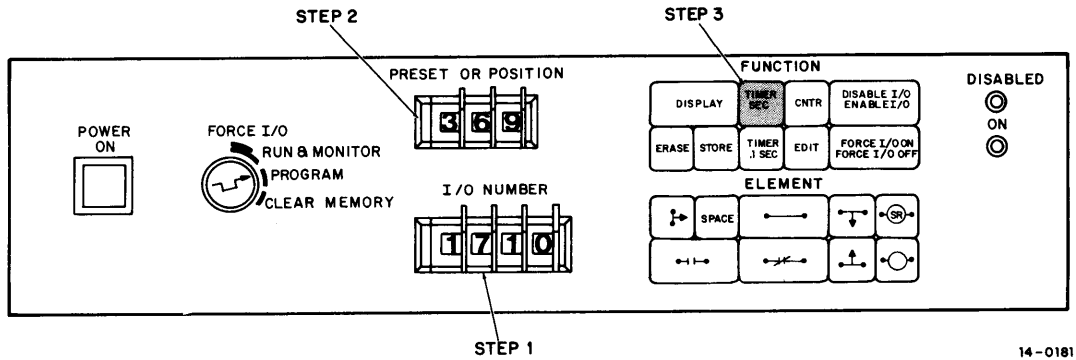

Figure 3-8 Timer (or Counter) Output 1710 Preset to 369 Seconds (Counts)

### PRESETTING TIMERS, EVENT COUNTERS, AND UP/DOWN COUNTERS

Timer, Event Counter, and Up/Down Counter circuits are entered in the same manner as any external output. After the circuit is entered, the timing interval or counting range must be preset. The timing interval range is either 0.1 to 99.9 seconds (TIMER 0.1 SEC key pressed) or 1 to 999 seconds (TIMER SEC key pressed). If the timing interval is greater than 999 sec, a timer must be cascaded with a counter (Appendix B). The counting range is 1 to 999 (CNTR key pressed). Presetting timer and counter values must be performed in either Program Mode (controller is not running) or Force I/O Mode (controller is running). To preset a timer or counter after the circuit is programmed:

1. Set the I/O NUMBER switches to the even number of the timer or counter.

2. Set the PRESET or POSITION switches to the desired timing or counting interval.
3. Press the applicable timer or counter function key. (Figure 3-8 illustrates the preceding steps.)

### ENTRY ERRORS

If an attempt is made to enter an illegal circuit, the VT14 will display ILLEGAL FORMAT. Figures 3-9 and 3-10 illustrate some examples of illegal circuits. The circuit in Figure 3-9a is redrawn in b to show that contact E is a vertical contact (i.e., logic flows through the contact in two directions). Figure 3-9c shows an equivalent circuit in a legal format. The illegal circuits shown in Figure 3-10a and b can be corrected by editing.

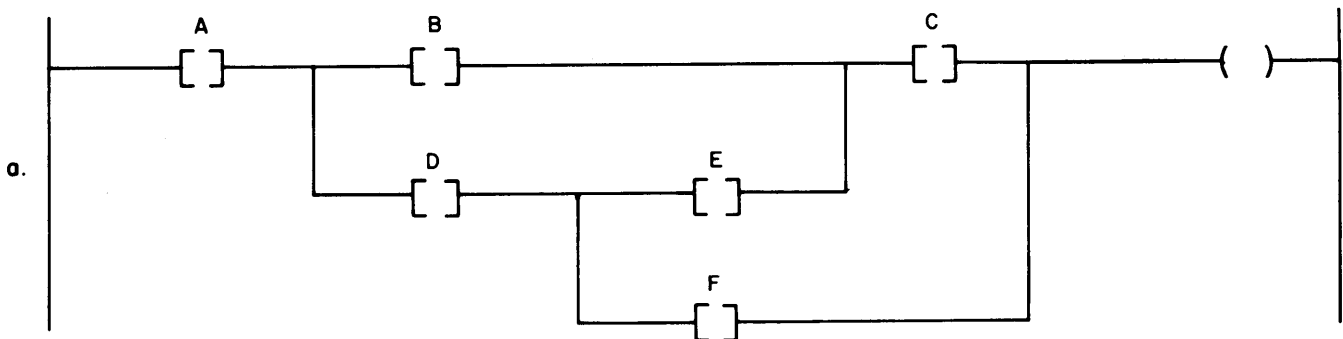
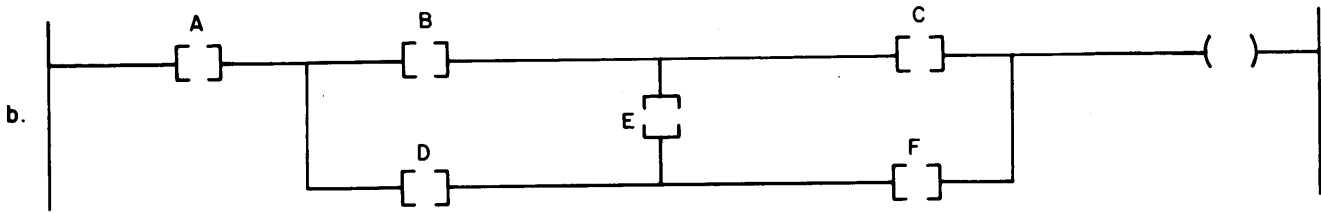

Figure 3-9a Typical Control Circuit Containing an Illegal Vertical Contact





14-0167

Figure 3-9b Reformatted to Emphasize the Vertical Contact

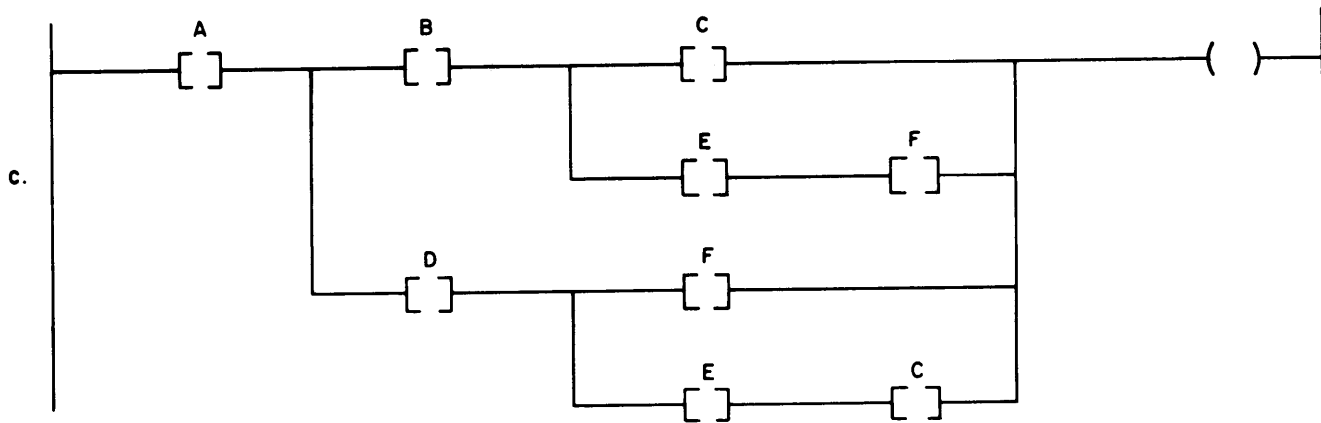

14-0168

Figure 3-9c Circuit 3-9a in Legal Format

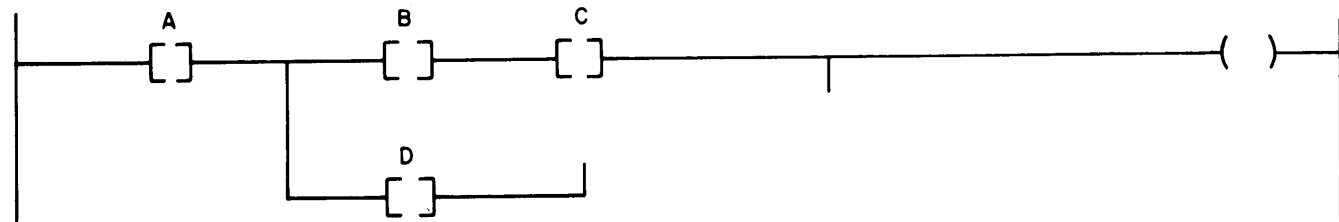

14-0169

Figure 3-10a Branches Illegally Offset

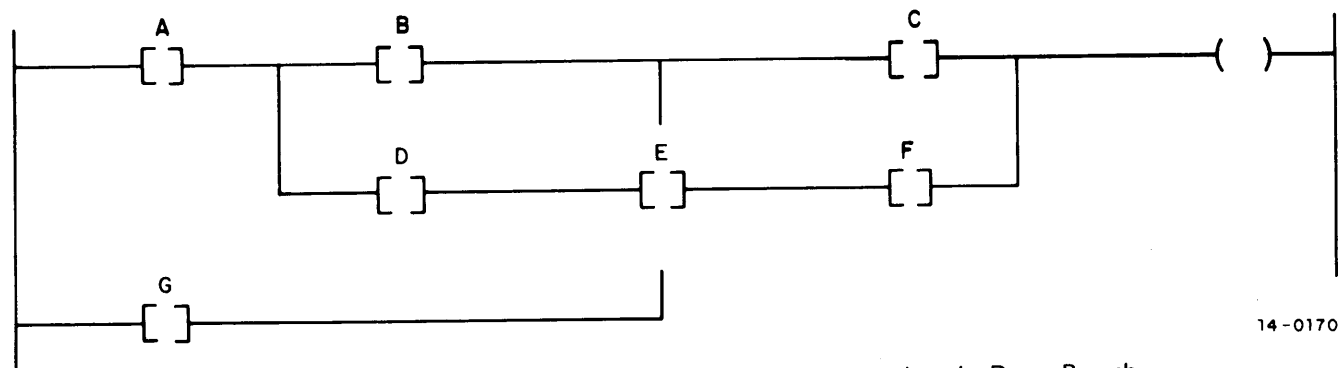

14-0170

Figure 3-10b An Element Illegally Drawn Between an Up-Branch and a Down-Branch

# CHAPTER 4 ON-LINE USE OF THE VT14

After entering all circuits to control your machine or process, you are ready to run the newly-developed program. This chapter details the VT14's on-line capabilities. You will find the VT14 to be an extremely helpful tool while debugging your machine — especially if you use some of the hints suggested later in this chapter.

**CHECKING I/O STATUS**

The VT14 front panel is equipped with I/O status lamps, which show the current state of any input, output, or internal function, that are located at the extreme right of the panel as seen in Figure 4-1. Whenever an input or output is dialed into the I/O NUMBER switches, its present state is displayed in these lights: The DISABLED light is lit if the point is disabled (discussed in a later section) and the ON light is lit if the point is on. This status is read from the controller and is continuously updated in all modes of operation. (You may notice a short delay after dialing in an I/O number before its state is reflected by the lights.)

**RUNNING THE CONTROL PROGRAM**

Whenever the VT14 is in program mode (i.e., the key switch is in the PROGRAM position), the controller is inoperative.

When the key switch is turned to the RUN & MONITOR position, the Industrial 14 controller will immediately begin sampling inputs and controlling outputs. Whenever the

VT14 is returned to program mode, all outputs will be de-energized. However, whenever the VT14 is switched from run and monitor mode to program mode and then back to run and monitor mode, the output states will be preserved and re-energized upon returning to run mode, provided the 14 was not powered down.

**MONITORING A CONTROL CIRCUIT**

While the controller is running, any circuit may be read from the controller's memory and displayed on the screen of the VT14. This is done as in program mode — by selecting the circuit in the I/O NUMBER switches and pressing the DISPLAY key.

While in run and monitor mode, the circuit displayed reflects the present condition of the circuit by intensifying contacts within the circuit. As seen in Figure 4-2, these intensified contacts show a "current path" through the circuit resulting in an energized (and therefore intensified) output. The normally-open contact is intensified when an I/O function is on; the normally-closed contact is intensified when an I/O function is off. This is true for all I/O functions (inputs, outputs, and internal functions).

When a timer or counter circuit is monitored, the current value is displayed on the screen and is updated continuously to the correct reading.

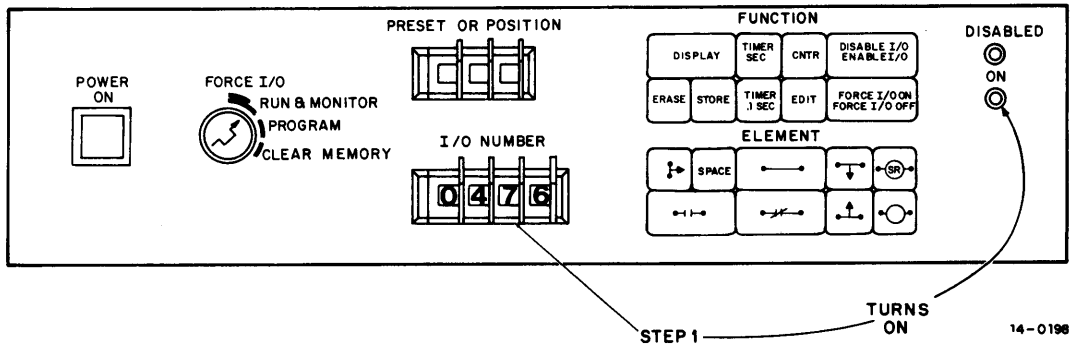

Figure 4-1 Sampling Input 476

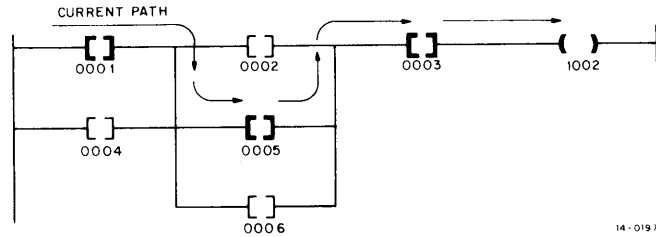

Figure 4-2 Typical Display of Intensified Control Circuit Symbols

### SUMMARY OF VT14 MODES

#### Force I/O Mode

The next several paragraphs discuss the VT14's capability to disable and force I/O states that are available only when the VT14's key switch is set to FORCE I/O. Table 4-1 lists the available functions of each of the operating modes. As indicated in this table, modifications to the controller's stored program can only be performed in program mode. Run and monitor mode permits the controller to operate and honor any established I/O disables and force states; circuits may be entered or modified on the VT14 screen

but not stored in the 14 memory; internal functions cannot be adjusted. Force I/O mode is identical to run mode with the additional ability of altering internal function presets and to disable I/O's and establish forced states.

#### Disabling I/O Points

The VT14 can logically override input and output states of the Industrial 14 controller. (Internal functions cannot be overridden in this fashion.) The logical override is accomplished by first disabling the input or output and then forcing it to either the on or off state. Figure 4-3 illustrates this feature.

Table 4-1  
VT14 Modes of Operation

| Operation                                       | Program Mode | Run & Monitor | Force I/O |
|---|--------------|---------------|-----------|
| 1. Enter a Circuit                              | X            | X             | X         |
| 2. Store a Circuit                              | X            |               |           |
| 3. Edit a Circuit                               | X            | X             | X         |
| 4. Remove a Circuit                             | X            |               |           |
| 5. Change Timer/Counter Presets                 | X            |               | X         |
| 6. I/O Status Lamps                             | X            | X             | X         |
| 7. Operate Controller                           |              | X             | X         |
| 8. Intensified Contact Display                  |              | X             | X         |
| 9. Set I/O Disables and Force I/O States        |              |               | X         |
| 10. I/O Disables and Forces in Effect           |              | X             | X         |
| 11. Hard Copy Print-out and Teletype Operations | X            |               |           |

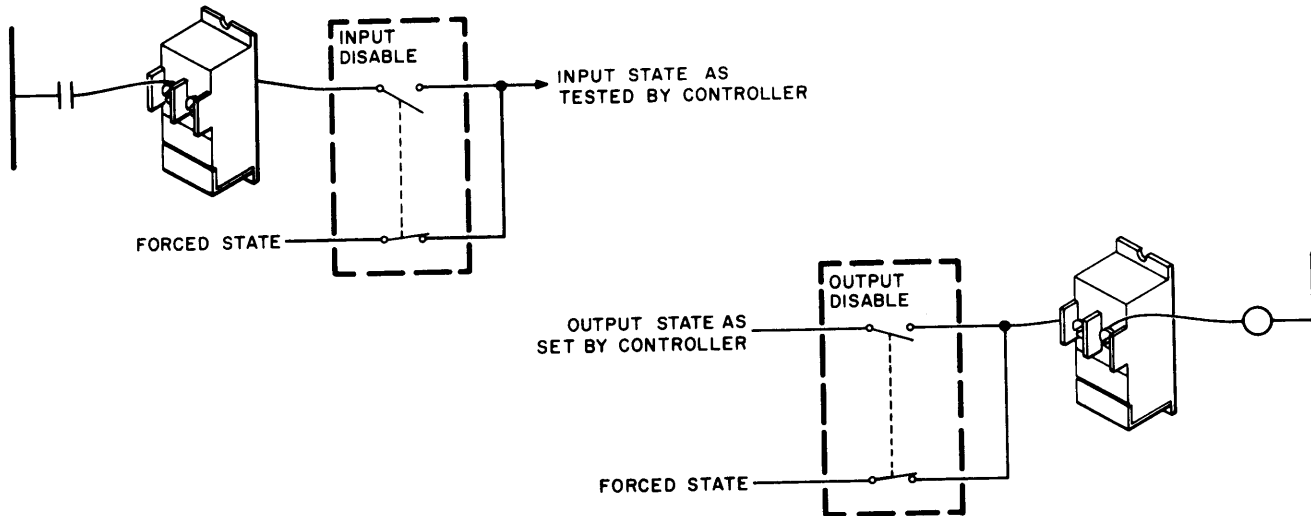

14-0210

Figure 4-3 Disabling Inputs and Outputs from the VT14

In the case of an input, the state, as tested by the controller, is the state of the input converter when the input is not disabled – and, is the forced state when the input is disabled.

In the case of an output, the state of the output converter is as set by the control program when the output is not disabled – and, is the forced state when the output is disabled.

To disable (or enable) an input or output:

1. Set the I/O NUMBER switches to the input or output number to be disabled.

2. Note whether the disable light is on or off. If it is off, press the DISABLE/ENABLE I/O key; the light will glow indicating that the I/O number set in Step 1 is disabled. Conversely, if the light is on, pressing this key turns it off indicating that the I/O number is enabled.

Figure 4-4 illustrates this procedure by disabling input 476.

Any combination of inputs and outputs may be disabled at the same time. The “disable” condition remains until it is removed by pressing the DISABLE/ENABLE I/O key again, with the proper I/O number setting.

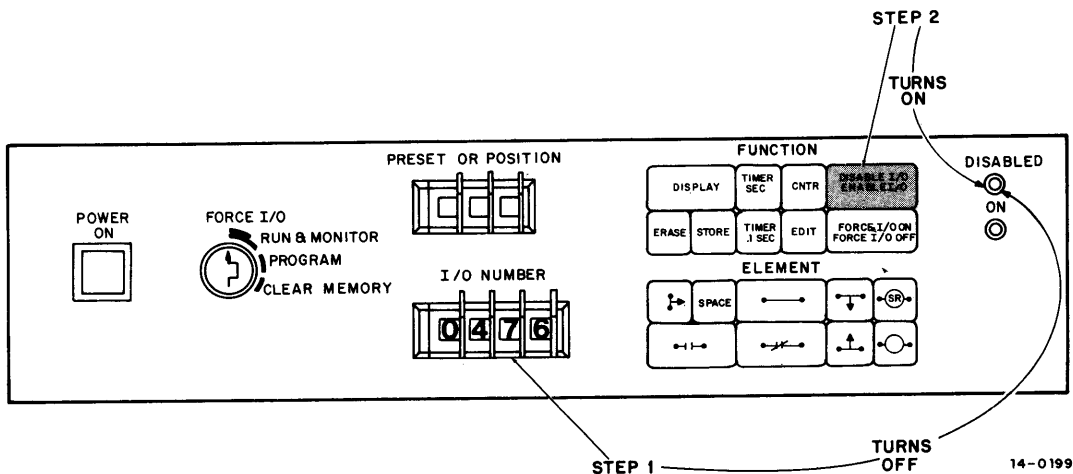

14-0199

Figure 4-4 Input 0476 Disabled

### Forcing Disabled I/O

After the input or output is disabled, it can be either forced on or forced off. The ON light on the VT14 panel reflects the current state of the input or output selected in I/O NUMBER switches; this is the forced state if it is disabled or is the true state if it is not disabled. This is also the state used by the controller when processing control circuits.

Following is a procedure for forcing an already disabled input or output, which is illustrated in Figure 4-5.

1. Set the I/O NUMBER switches to the input or output number to be forced.
2. Note whether the ON light is on or off. If it is

off, press the FORCE I/O ON/OFF key to turn on the light and the output. Conversely, if the light is on, pressing the switch will turn it and the output off.

### Using The Disable/Force Feature

Following is a practical example of the information presented above. Figure 4-6 is a control circuit that turns on the automatic cycle light for one station on a transfer line. To turn on the automatic cycle light without actually having either the MAIN CYCLE or CYCLE START pushbutton on, first disable and then force on the CYCLE START and MAIN CYCLE contacts as depicted by Figure 4-7.

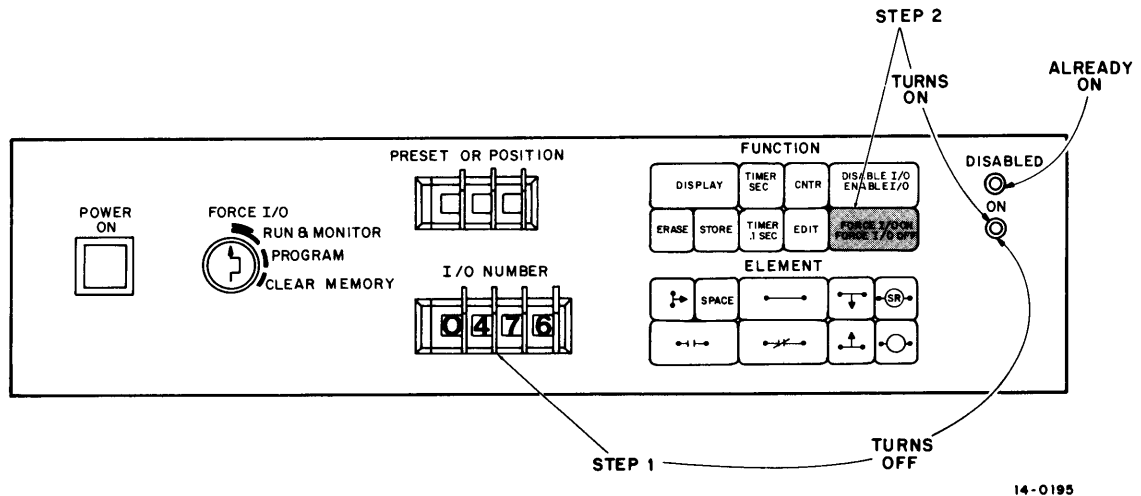

Figure 4-5 Contact 0476 Forced On

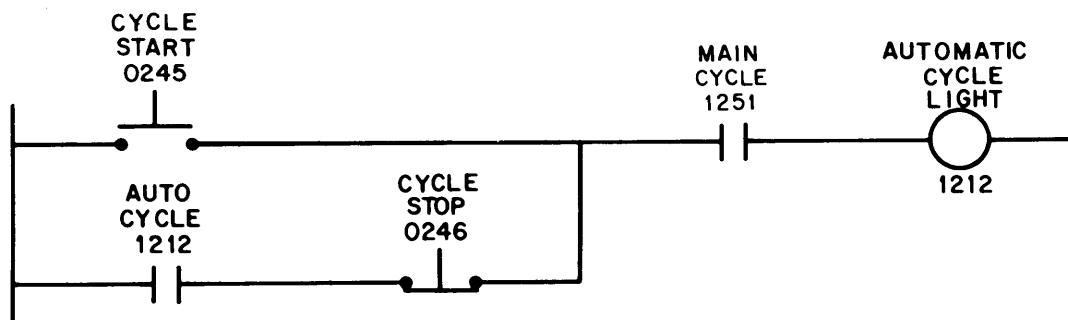

Figure 4-6 Automatic-Cycle-Light Control Circuit

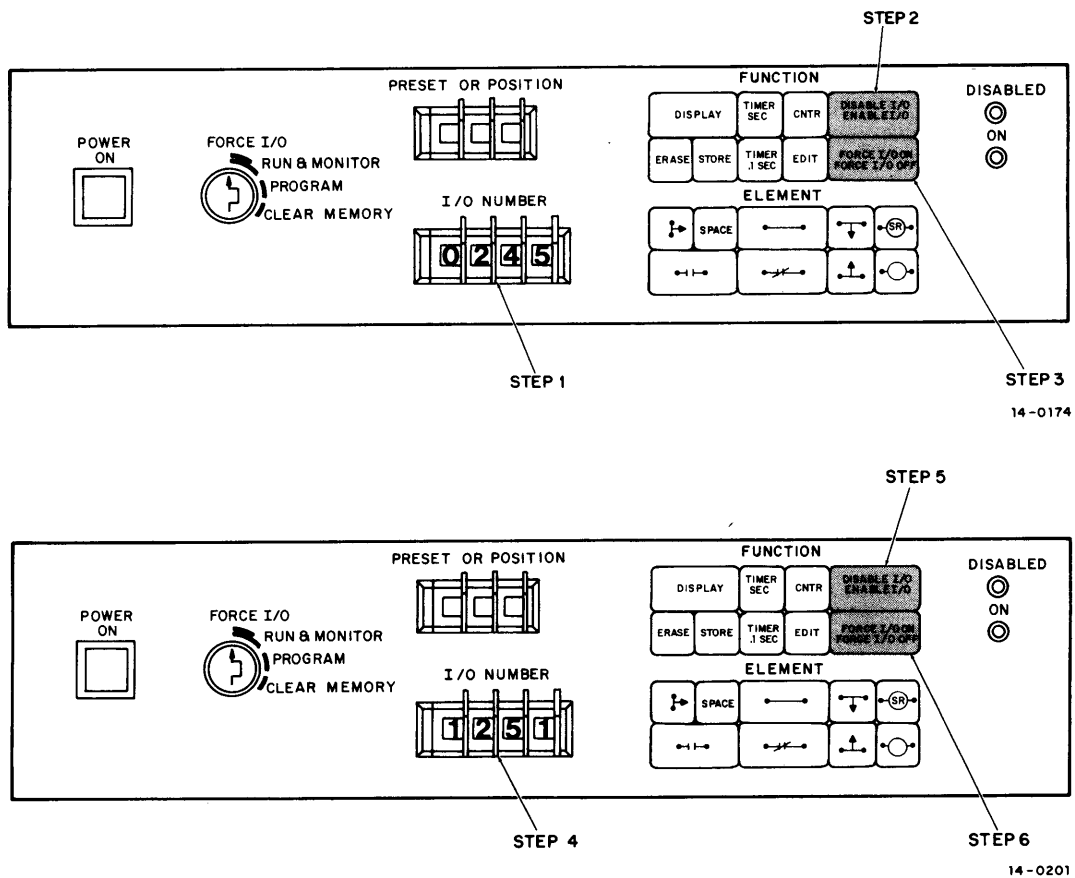

Figure 4-7 Disabling and Forcing On the CYCLE START and MAIN CYCLE Contacts

To see that the automatic cycle circuit will remain on after the cycle start pushbutton is released, force the CYCLE START contact 245 off. To turn the automatic cycle light off, disable the CYCLE STOP contact 0246 and force it off.

After you have finished checking the circuit, remember to re-enable the disabled inputs and outputs.

The disable and force features are also used

1. to prevent an output from energizing at all during checkout, by disabling and forcing it off.
2. to achieve a dry run when the logic requires that a part be in place during checkout, by disabling the part-in-place input and forcing it on.
3. when some inputs required are not yet wired into the controller during checkout. Simply

disable the inputs that should be on, and force them accordingly.

4. when an input is suspected to be intermittent. Simply disable it and force it to the state it is supposed to be in. If the problem disappears, the input truly is intermittent and the switch and/or input converter should be checked.

I/O disables only remain in effect as long as the 14 is powered up. To clear all I/O disables, simply power down the controller with the power supply ON/OFF switch.

#### Forcing An Enabled Output

Any output or internal function may be forced to the opposite state whether or not it is disabled. However, if the output is currently enabled, the control program can return the output to its original state almost immediately. This feature is particularly useful for clearing or setting internal functions like timers, counters, retentive memories, shift registers etc., which cannot be disabled. It is also helpful to turn an output on that uses a sealing contact.

## CHANGING A CIRCUIT

A circuit may be changed while the VT14 is in the FORCE I/O or the Run and Monitor mode. However, to store the altered circuit, the VT14 must be switched to program mode.

An edited circuit is not executed until it is stored, but it is monitored and the contacts intensified according to present I/O status. To store the circuit and therefore cause the Industrial 14 controller to use this revised logic:

1. Set the mode switch to PROGRAM; the controller will stop operating and set all its outputs off.
2. Press the STORE key to store the displayed circuit; wait for the screen to display the word DONE.
3. Set the mode switch to RUN & MONITOR to execute the changed circuit; outputs will be returned to their state prior to the mode change from RUN & MONITOR.

If, after any editing operation, you desire to return to run mode without setting outputs on that had been on, simply power the Industrial 14 controller down. This will clear all outputs – unless programmed to clear on a power down – although internal functions will be unchanged.

## HINTS FOR THE USE OF THE VT14

After you become familiar with its use, you will find the VT14 to be a very powerful machine de-bugging tool. Here are a few hints you may find helpful:

1. **Checking Input Field Wiring**  
Before you begin to run your machine it may be wise to check that all the inputs and outputs are properly wired to the Industrial 14 controller. This is easily accomplished with the VT14 – simply dial each input number and watch the ON light as the input is manually tripped.

Or you may build a “checkout” circuit by using an unused output number and displaying as many as 72 input states. Figure 4-8 shows a circuit using output number 1370 to display the first 64 inputs. Now you can simultaneously view many inputs and by watching them intensify, determine if your field wiring is correct.

If you wish, this circuit may be stored in the controller’s memory for use in troubleshooting at any time. Similar circuits can be constructed, for example, using outputs 1371–1373 to display all the possible input points in groups of 64.

2. **Checking Output Field Wiring**  
In many applications you may also wish to see if the output connections are wired properly. This is readily accomplished by disabling each output in sequence, then forcing it ON and forcing it OFF, to ensure that the proper activation occurs.

Be sure to remove the disables as previously discussed before attempting to run the machine.

3. **Checking Interaction Between Control Circuits**  
The VT14’s ability to display a control circuit showing the state of all contacts is a very powerful debugging tool. But there are times when you would like to see more information than that contained in a single circuit.

While in monitor mode, you may put other contacts on the screen. Simply use the EDIT key to position the cursor in an unused portion of the display, and enter the contact (or contacts) you wish to monitor. They are intensified just as if they were part of the circuit but they have no affect on the circuit since they are not stored in the controller’s memory.

4. **Using Dummy Circuits During Checkout**  
Since all the output logic is built into the 14/30 and 14/35 controllers, and since you will often have extra memory available to you, you may wish to construct some dummy circuits that can give you machine status at a glance.

For example, you can string shift register bits in series to observe a part moving through the system. Or you can enter a circuit which is comprised of all valves so you can quickly view the status of a batching system.

Using a few extra outputs and a little imagination, the VT14 can give you a tremendous amount of status information on its viewing screen.

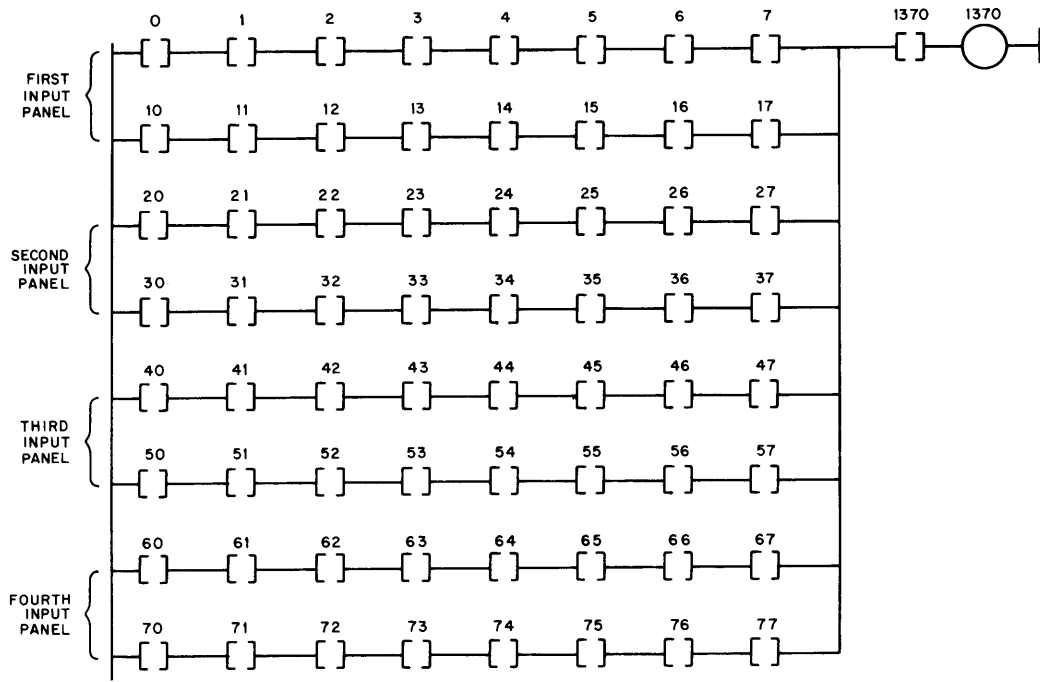

14-0220

Figure 4-8 Sample Circuit to Display Input States



# APPENDIX A

## VT14 PROGRAM DOCUMENTATION

With an ASR-33 Teletype Option, a copy of a particular circuit or all circuits can be printed out or punched on paper tape. Set the VT14 mode switch to PROGRAM and the Teletype to ON LINE and then perform any of the following procedures.

To obtain a copy of a particular circuit

1. Set the I/O NUMBER switches to the I/O number for the circuit.
2. Type L (it will not be echoed on the printer).
3. The Teletype will print NONE if the specified circuit is not in 14 memory.

To obtain a copy of all ladder diagrams

1. Type B (it will not be echoed on the printer).
2. VT14 will print DONE on the Teletype when all ladder diagrams have been drawn or punched.

To punch a VT14 Program Tape\*

1. Turn the punch on.
2. Type P (it will not be echoed on the printer).
3. The VT14 will display DONE when the tape is finished.

4. All punched tapes should be verified.

To Read a VT14 Program Tape\*

1. Insert the VT14 program tape in the reader.
2. Turn the reader on.
3. Type R (it will not be echoed on the printer).
4. VT14 will display OK if the program is read correctly. If the program is not read correctly, a CHECKSUM ERROR message is displayed.

To verify the VT14 program tape with the program stored in 14 memory\*

1. Insert the VT14 program tape in the reader.
2. Turn the reader on.
3. Type V (it will not be echoed on the printer).
4. VT14 will display OK if the program is verified correctly. If the program is not verified correctly, either a DATA ERROR or CHECKSUM ERROR message is displayed.

\*The ADDR ERROR light on the 14 control unit will be lit upon reading, punching and verifying a VT14 program tape.

## APPENDIX B

### CASCADING A TIMER AND COUNTER

A timer interval greater than 999 seconds can be obtained by cascading a timer with a counter. The preset value of both can be determined with the following equation:

For example, if a 1-hour (3600 sec.) timer is desired, preset the timer to 60 seconds and the counter to 60. This example is illustrated in Figure B-1.

$$\text{TOTAL ELAPSED TIME} = \text{TIMER PRESET VALUE} \times \text{COUNTER PRESET VALUE}$$

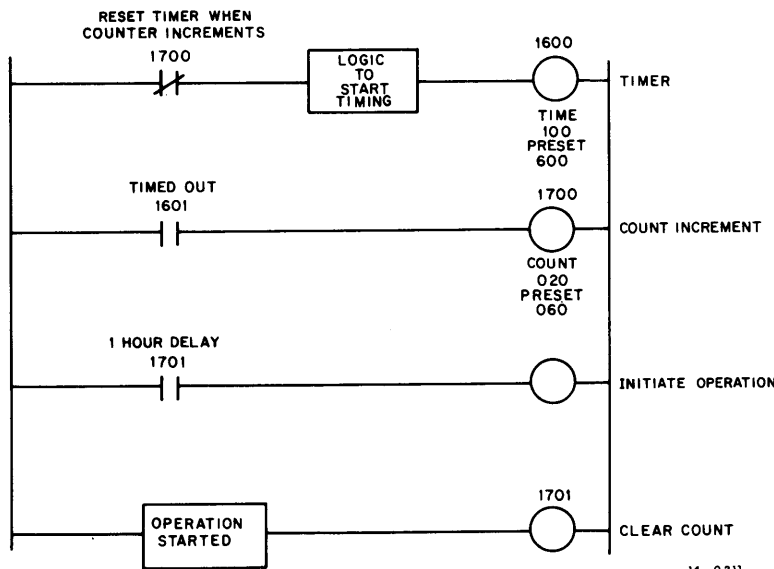
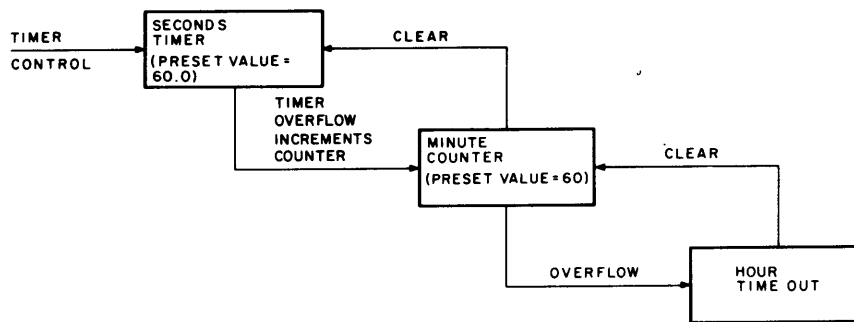

14 - 0211

Figure B-1 Cascading a 60-Second Timer With a 60-Minute Counter

## APPENDIX C

### VT14 INSTALLATION

When the VT14 shipping carton is opened, check the contents of the carton against the packing list. Unpack the VT14 and thoroughly inspect it for physical damage before it is connected to the Industrial 14 controller. If damage is discovered, determine whether or not normal operation is in any way impaired. Contact your DIGITAL Field Service Representative for assistance with evaluating the damage to the terminal.

Following is the VT14 Installation Procedure:

1. Remove the wooden shipping panel from the VT14. (Do not discard the panel. It can be used if you have to ship the VT14 back to DIGITAL.)
2. Put the VT14 in the place in which it is to be used.
3. Connect the grey serial-line interface cable (BC14-J) from the back of the VT14 to the PROGRAM or MAINTENANCE PANEL connector on the Industrial 14 controller.
4. If you have a Teletype<sup>®</sup> with your unit, connect the Interface Cable attached to the back of the VT14 to the Teletype signal cable.
5. Plug the VT14 Power Cord into a properly grounded 115 V (or 240 V, if specified) ac line. Check the label on the rear panel of the VT14 to determine the proper line voltage.
6. Insert the key and turn the mode switch to PROGRAM.
7. Press the VT14 POWER ON switch. This switch should glow and vertical dashed lines should appear at the extreme left and right edges of the screen. Allow a 60-second warm-up period before operating the VT14.
8. If the POWER ON switch does not glow, check the rear panel circuit breaker to see if it is open (pushbutton protruding). If so, reset the breaker and repeat Step 7. If the POWER ON light still does not glow, consult your DIGITAL Field Service Representative for assistance.
9. If the POWER ON light is on and the vertical dashed lines do not appear, adjust the CONTRAST and BRIGHTNESS potentiometers on the rear panel.
10. If the vertical dashed lines still do not appear, repeat Steps 7–9. If there is still a problem, contact your DIGITAL Field Service Representative for assistance.
11. If the VT14 displays a blinking ERROR or a 14 HUNG message, power down the 14/30,/35 and immediately power it up again. If the condition persists, a blinking ERROR message indicates that the 14 controller is not on or the serial-line interface is malfunctioning; a blinking 14 HUNG message indicates a malfunction in the 14 controller.
12. When a new program is to be entered into the controller, the 14's memory should be cleared as described in Chapter 3 of this manual.
13. Set the mode switch to PROGRAM. The VT14 terminal can now be used to program the VT14 controller.

#### CAUTION

**The VT14 Terminal and the Industrial 14 Controller should be connected to a common ground to prevent shock hazards.**

**APPENDIX D**  
**CIRCUIT GRID FORMS**

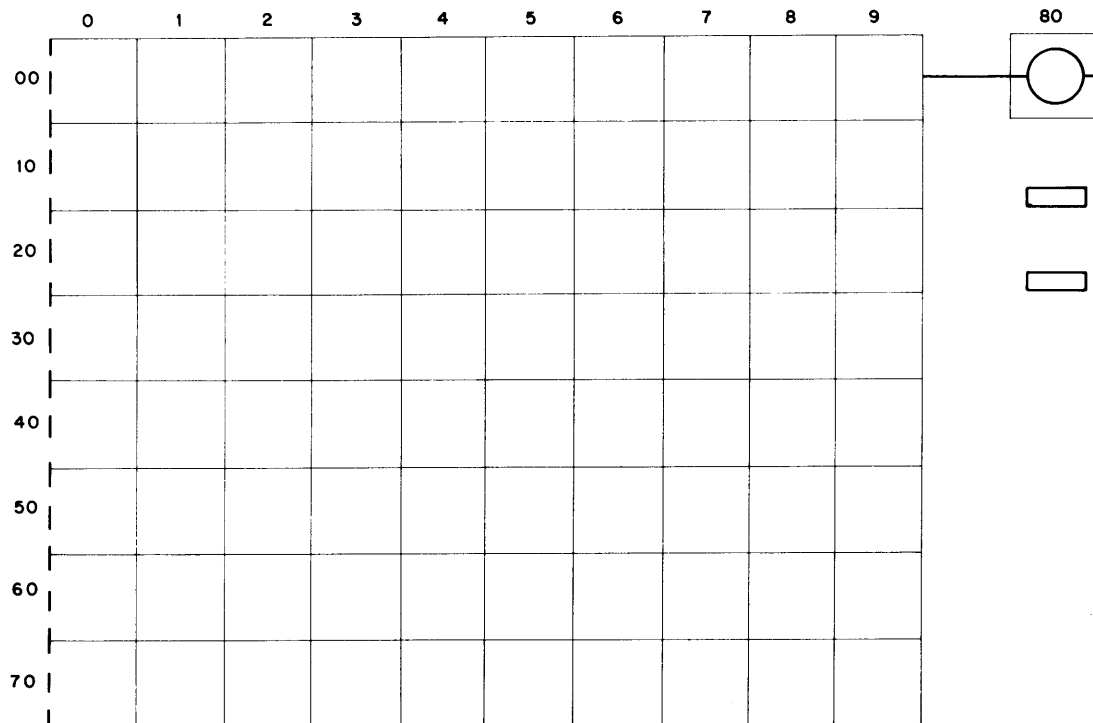
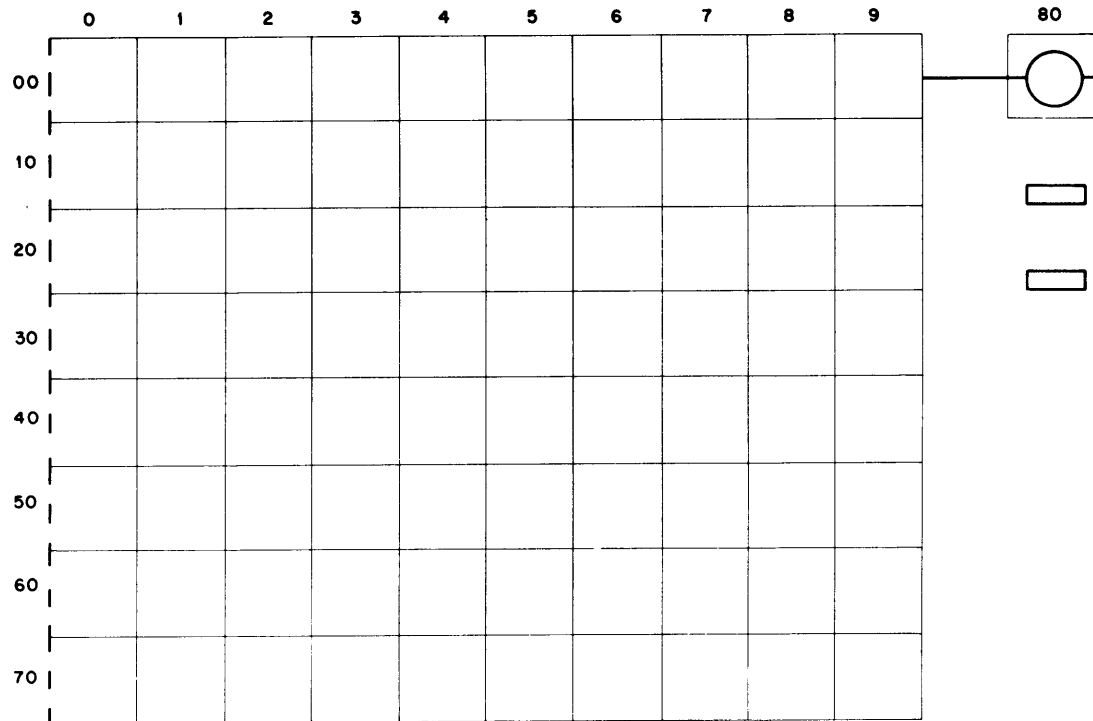

14-0219

Figure D-1 Circuit Entry Grid Forms

# Reader's Comments

Your comments and suggestions will help us in our continuous effort to improve the quality and usefulness of our publications.

What is your general reaction to this manual? In your judgment is it complete, accurate, well organized, well written, etc.? Is it easy to use? \_\_\_\_\_  
\_\_\_\_\_  
\_\_\_\_\_

What features are most useful? \_\_\_\_\_  
\_\_\_\_\_  
\_\_\_\_\_

What faults do you find with the manual? \_\_\_\_\_  
\_\_\_\_\_  
\_\_\_\_\_

Does this manual satisfy the need you think it was intended to satisfy? \_\_\_\_\_

Does it satisfy *your* needs? \_\_\_\_\_ Why? \_\_\_\_\_  
\_\_\_\_\_  
\_\_\_\_\_

Would you please indicate any factual errors you have found. \_\_\_\_\_  
\_\_\_\_\_  
\_\_\_\_\_

Please describe your position. \_\_\_\_\_

Name \_\_\_\_\_ Organization \_\_\_\_\_

Street \_\_\_\_\_ Department \_\_\_\_\_

City \_\_\_\_\_ State \_\_\_\_\_ Zip or Country \_\_\_\_\_

-----  
**Fold Here**  
-----

-----  
**Do Not Tear - Fold Here and Staple**  
-----

**FIRST CLASS  
PERMIT NO. 33  
MAYNARD, MASS.**

**BUSINESS REPLY MAIL  
NO POSTAGE STAMP NECESSARY IF MAILED IN THE UNITED STATES**

**Postage will be paid by:**

**Digital Equipment Corporation  
Technical Documentation Department  
Digital Park, PK3-2  
Maynard, Massachusetts 01754**

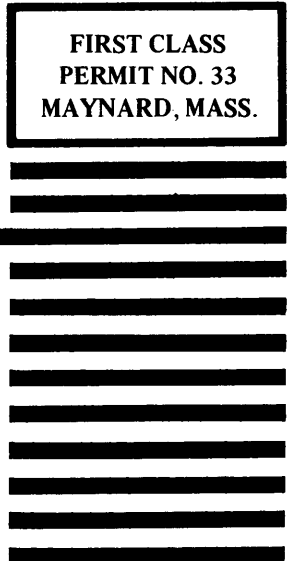

digital

INDUSTRIAL 14 FAMILY

14

OF CONTROLLERS