

IDENTIFICATION

Product Code:	DEC-12-ZR1A-D
Product Name:	DIAL-MS Assembler Program Description
Date Created:	July 1, 1970
Maintainer:	Software Services



LAP6-DIAL is an editor, filing system and assembler for use with the PDP-12 computer. The editor and filing portions are derived from the basic LINC program LAP6<sup>1</sup> by Mary Allen Wilkes of Washington University. The assembly portion is derived from several programs used for the PDP-8 computer including PAL-D<sup>2</sup>.

The Digital Equipment Corporation wishes to express to the author, Mary Allen Wilkes (Clark), and the Computer Research Laboratory of Washington University, St. Louis, Missouri, its appreciation for the development set forth in LAP6 as well as its thanks for permission to use parts of the LAP6 program.

---

<sup>1</sup>M. A. Wilkes, LAP6 Handbook, Computer Research Laboratory Tech. Rep. No. 2, Washington University, St. Louis, May 1, 1967.

<sup>2</sup>PAL-D Assembler Programmer's Reference Manual DEC-D8-ASAA-D.

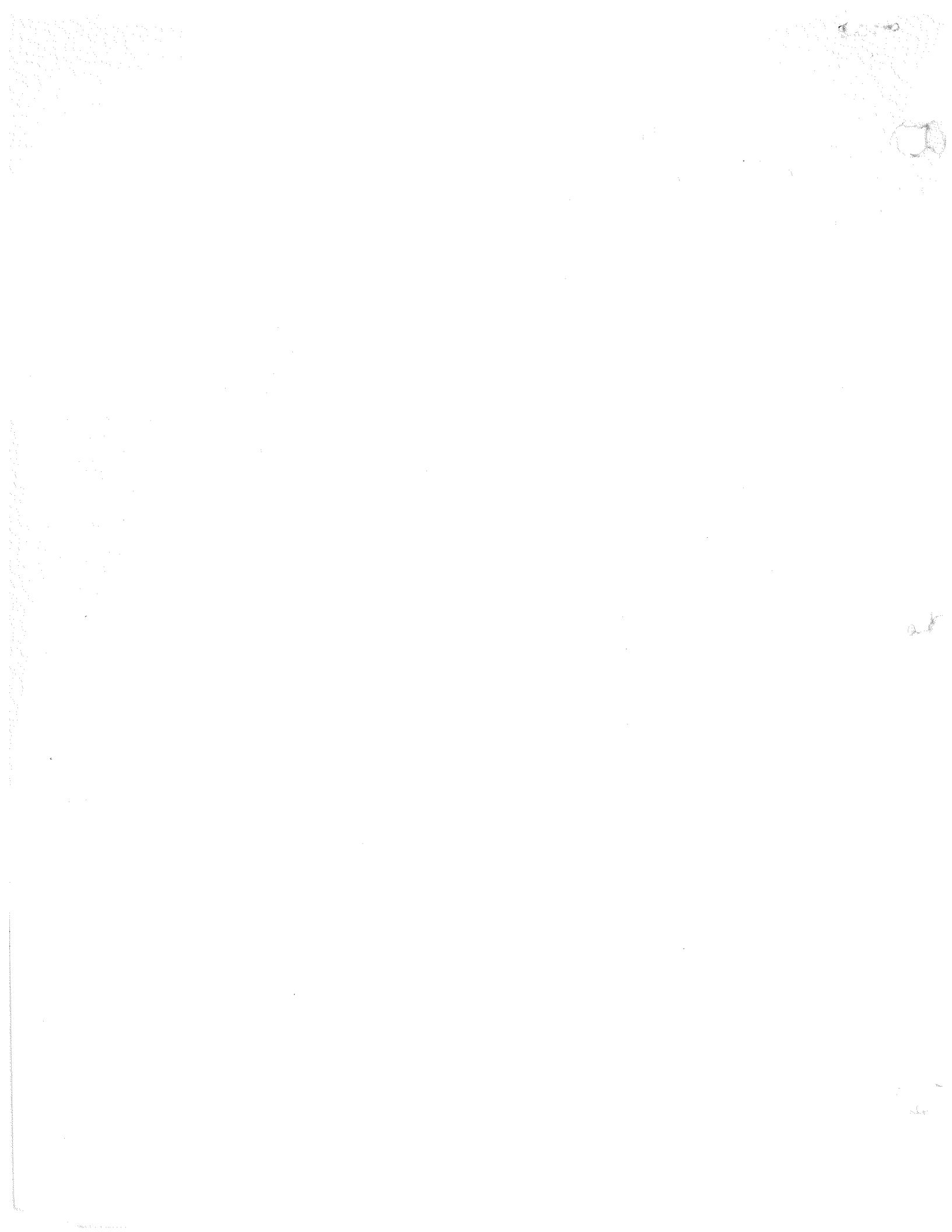

## 1.0 PROGRAM OVERVIEW

The DIAL Assembler is a bilingual assembler which can assemble program which have been edited by the DIAL editor or entered by PIP.

Additional features to the assembler are:

1. Ability to save and load parts of the symbol table
2. Conditional assembly of various lines
3. Listing between line numbers
4. A "quick list" entry point which removes comments and line numbers and replaces tabs by blanks
5. Listing on disk or tape
6. Chaining between source files.

This assembler is based on PAL-D which, in turn, was based on MACRO-8. Most of the routines in the DIAL Assembler will be found and described in the PAL-D or MACRO-8 system description.

## 2.0 ENVIRONMENT

The Assembler leaves its binary output in the Working Area on tape 1 (blocks 370-427), and the header block in 447. The Assembler itself (including necessary scratch blocks) resides in blocks 324-345 of tape 0.

## 2.1 LOADER MAP

0000-0177	Page 0: Common literals and pointers
0200-0377	Bank Check Routine; Symbol Search Routine
0400-0577	Symbol Table Getter Routine
0600-0777	Routine to get a symbol from Symbol Table (or add on). Ring buffering routines
1000-1177	General Recursive Expression Evaluator
1200-1377	Recursive Address Evaluator
1400-1577	Central Processing Loop, Main Start of Assembler after Initialization
1600-1777	Text Processor, Current Line Tester, plus Minor Support Routines
2000-2177	An Input Character Scanner Routine, the output buffer routine and tab routine
2200-2377	Number Conversions, Type Checks
2400-2577	Symbol Sort for Output, Teletype Routine
2600-2777	Symbol Output and Value Routine, Octal Print Routine, Field Change Routine, and Work Area
3000-3177	Output List Routine, 8K Pseudo Op Initialization (destroyed and never used) Work Area
3200-3377	Error Message Processor, Type Evaluator, System Symbol Table Swapper, Fairly Low Level Character Getter, and Routine to Skip if Not Pass 2 or Not in List Mode
3400-3577	Input Character Convertor to Internal Form, Plus Page Checkers, Other Little Routines
3600-3777	Internal to External Character Convertor, Symbol Table Type Getters and Setters  Low Level Character Getter, Ccmment Processor, List and No List Processors
4000-4177	General Tape I/O Call Routines, Initialization for Tape Routines, Other Short Routines
4200-4377	More Tape I/O Routines, Pseudo Op Processor, and Loader Core Map
4400-4777	Input Buffer and Swapped In and Out Work Area for SAVSYM and LODSYM
5000-5377	Output Buffer, plus Initialization for Entire Assembler after it is first loaded in

54000-5777	Pseudo-Op Processor
60000-6377	Line Printer Checker and Basic Line Printer Routine. Ring buffer
64000-6777	Listape Buffer
70000-7777	DIAL-MS routines
100000-16777	User defined symbols
170000-17377	System Mode Symbols (L-mode or P-mode)
174000-17577	Pseudo Ops and Special Character Table

### 3.0 THE PSEUDO OP PROCESSOR

After the desired pseudo op is found in the table by "EXPR", it then Jumps to an ISZ chain. The ISZ chain is a group of sequential ISZs of location "OPL". After falling through the ISZs, OPL contains the desired pseudo op number; the routine then JMSs to it with the desired operation number in the AC.

### 4.0 SYMBOL TABLE ORGANIZATION

A symbol table entry is composed of four words. The first three words are the name and the last is the value. If the symbol is a pseudo-op, then the last word contains a pointer to the routine which will process the pseudo op and the rest of the statement.

The name is composed of six characters. These characters are usually the 26 alphabetic letters plus 10 numbers plus a null character if less than six letters long, permitting 45 octal possible characters for the left or the right half of

a word. If six bit notation were used, 23 possible positions on the character would be wasted; therefore, six bit is not used. The first character of a name must be a letter, thus leaving only 32 octal combinations for the first character. If the left characters of a word are multiplied by 45, there are two free bits in the first word of a name ( $32*45 < 2000$  octal). These two left bits are used as follows:

00:	Special Character
01:	Undefined
10:	Defined
11:	Pseudo operation

## 5.0 SUBROUTINES

### 1. Initialization

NAME:	<u>SETORG</u>
FUNCTION:	Called at the beginning of each pass to initialize counters, pointers, and tables. Sets origin to SEGMENT 2.
INPUT:	Clear AC.
OUTPUT:	Clear AC.
MAJOR REGISTERS CHANGED:	AADR, APAGE, EVAL, ABANK

NAME:	<u>RESET</u>
FUNCTION:	Called when a new page is to be started to initialize pointers.
INPUT:	Clear AC.
OUTPUT:	Clear AC.
MAJOR REGISTERS CHANGED:	APAGE.



2. Input

NAME: GETIN

FUNCTION: Gets an 8-bit character from GETCHR. Saves it in ITEM. Also scans off comments if in QUICK LIST mode.

MAJOR REGISTERS CHANGED: ITEM

3. Input Conversion

NAME: BIT6

FUNCTION: Translates the 8-bit ASCII character in ITEM to its 6-bit internal code.

INPUT: Clear AC

OUTPUT: 6-bit internal code in AC

MAJOR REGISTERS CHANGED: None

4. Output

NAME: PUNONE

FUNCTION: Outputs the contents of EVAL (the generated binary).

1. PASS 1 - no operation
2. Save word in correct core location. If correct block not in core, it calls NOTBC1 to load it in.

INPUT: Clear AC when EVAL contains assembled binary.

OUTPUT: Clear AC.

MAJOR REGISTERS CHANGED: CUNADD.

Output (cont.)

NAME: OPS

FUNCTION: This is the octal print routine. It converts the binary word in the AC to 4 octal characters (8-bit ASCII code) and calls TYPO to output them..

INPUT: Value to be output in AC.

OUTPUT: Clear AC.

MAJOR REGISTERS CHANGED: None.

NAME: EMPTY

FUNCTION: Outputs the contents of the symbolic buffer via TYPO during optional PASS 2. It then calls TYCAR to output a carriage return/line feed.

INPUT: Clear AC.

OUTPUT: Clear AC.

MAJOR REGISTERS CHANGED: CHARAC - the buffer counter/pointer.

NAME: TYCAR

FUNCTION: Outputs a carriage return and a line feed in 8-bit ASCII code via two calls to TYPO.

INPUT: Clear AC.

Output (cont.)

OUTPUT:	Clear AC
MAJOR REGISTERS CHANGED:	None.
NAME:	<u>UNTRAN</u>
FUNCTION:	Converts the 6-bit internal code character in the AC to 8-bit ASCII and then calls TYPO to output it.
INPUT:	Internal code character in AC.
OUTPUT:	Clear AC.
MAJOR REGISTERS CHANGED:	TYCAR - symbol character counter.
NAME:	<u>OX</u>
FUNCTION:	Used to decode a word of a symbol table entry by dividing by $45_8$ and then calling UNTRAN twice to output the two characters that are now in 6-bit internal code.
INPUT:	Word to be decoded in AC.
OUTPUT:	Clear AC.
MAJOR REGISTERS CHANGED:	LWC, HIC, MPI

Output (cont.)

NAME: OSYM

FUNCTION: Outputs the symbol in TEM1A-TEM1A+2. It initializes the symbol character counter, TYCAR, and then calls OX once for each word of the symbol.

INPUT: Clear AC.

OUTPUT: Clear AC.

MAJOR REGISTERS CHANGED: TYCAR

NAME: OSANDV

FUNCTION: Outputs a symbol via OSYM and its value via OPS. It calls SKIP2 to output spaces for format and TYCAR for a terminating carriage return/line feed.

INPUT: Clear AC.

OUTPUT: Clear AC.

MAJOR REGISTERS CHANGED: None.

NAME: SKIP2

FUNCTION: Outputs spaces (8-bit ASCII) for formatting purposes via TYPO.

INPUT: 2's complement of number of spaces in AC.

Output (cont.)

OUTPUT: Clear AC.

MAJOR REGISTERS CHANGED: None.

NAME: ALPHA

FUNCTION: Called at the end of PASS 2 to output an alphanumeric ordered symbol table print of all the defined symbols and their values. It uses the following "lower level" output routines to accomplish this: LT2, TYPE, TYCAR and OSANDV. It also uses  
MOVE - the triple precision moving routine,  
TRIPLE - the triple precision comparison routine.  
and GETYPE - to determine the type of the symbol currently being ordered.

INPUT: Clear AC.

OUTPUT: Clear AC.

MAJOR REGISTERS CHANGED: SADR, auto-index  $16_8$ , TEM1-TEM3, TEM1A-TEM1A+2, and VAL.

NAME: ONEREG

FUNCTION: This routine is entered with the AC containing the value that is to be loaded into the location now pointed

Output (cont.)

at by AADR (the current address counter) when the assembled program is to be run. This value is output via PUNONE.

INPUT: Value to be output in AC.

OUTPUT: Clear AC.

MAJOR REGISTERS CHANGED: EVAL  
AADR - incremented by 1.  
TYPINST+page number - this contains the highest instruction address +1 and was changed if the value just output was the highest instruction so far on this page.

NAME: ERROR

FUNCTION: Called to output error message (8-bit ASCII) via TYPO corresponding to error number in the AC. The error address is either relative to a symbolic tag or absolute depending on whether or not a tag has been encountered since the last origin setting.

INPUT: Error number in AC.

OUTPUT: Clear AC.

MAJOR REGISTERS CHANGED: None.

## 5. Pseudo-Instruction Processors

NAME:	<u>PAGEC</u>
FUNCTION:	Handles the PAGE pseudo-op. Calls EXPR to see if a page number follows PAGE. If so, the origin is set to the beginning of that page. If no number is specified, the origin is set to the beginning of the next page. PUNORG is called to punch the new origin.
INPUT:	Clear AC.
OUTPUT:	Clear AC.
MAJOR REGISTERS CHANGED:	AADR, EVAL
NAME:	<u>PERIOD</u>
FUNCTION:	Handles the "." pseudo instruction. Combines the value of the current address counter, AADR, with the value already accumulated according to the last operator received. If in LMODE, AADR is ANDED with 1777.
INPUT:	Clear AC.
OUTPUT:	Clear AC.
MAJOR REGISTERS CHANGED:	CON (indirectly).

Pseudo-Instruction Processors (cont.)

NAME: H

FUNCTION: Handles the "!" pseudo instruction. The indirect indicator register is set to 400<sub>8</sub> and the scanning for the rest of the expression resumes at A+1.

INPUT: Clear AC.

OUTPUT: Clear AC.

MAJOR REGISTERS CHANGED: H+3

NAME: ORGIC

FUNCTION: Handles the "\*" pseudo instruction. EXPR is called to get the address of the new origin which follows the \*. PUNORG is called to punch the new origin.

INPUT: Clear AC.

OUTPUT: Clear AC.

MAJOR REGISTERS CHANGED: AADR

NAME: STRING

FUNCTION: This handles the TEXT pseudo-instruction. It uses calls to GETIN



Pseudo-Instruction Processors (cont.)

to input the beginning delimiter, the string of characters, and the terminating delimiter in 6-bit DIAL code. It then uses calls to ONEREG to output two string characters per register in 6-bit DIAL code.

INPUT: Clear AC.

OUTPUT: Clear AC.

MAJOR REGISTERS CHANGED: VAL, EVAL, ITEM.

NAME: FIELDM

FUNCTION: Handles the FIELD pseudo-instruction. EXPR is called to pick up the bank designation which follows FIELD. This memory bank designator is output (pass 2 only) via TYPO2 in a format acceptable to the binary loader.

INPUT: Clear AC.

OUTPUT: Clear AC.

MAJOR REGISTERS CHANGED: None.

NAME: DECIM

FUNCTION: Handles the DECIMAL pseudo-instruction. Calls the subroutine DECIMS, which by

## Pseudo-Instruction Processors (cont.)

setting a switch in the MT10 sub-routine, effects all subsequent numbers to be considered in the decimal radix.

INPUT: Clear AC.

OUTPUT: Clear AC.

MAJOR REGISTERS CHANGED: MTSW - the switch register.

NAME: OCT

FUNCTION: Handles the OCTAL pseudo-instruction. Calls the subroutine OCTS, which by setting a switch in the MT10 sub-routine, effects all subsequent numbers to be considered in the octal radix.

INPUT: Clear AC.

OUTPUT: Clear AC.

MAJOR REGISTERS CHANGED: MTSW - the switch register.

## 6. Symbol Table Routines

NAME: SEARCH

FUNCTION: Searches the symbol table for the symbol found in TEM1, TEM2, and TEM3.

INPUT: Clear AC.

Symbol Table Routines (cont.)

OUTPUT:	Clear AC.
MAJOR REGISTERS CHANGED:	SADR, Autoindex $16_8$ , INST, VAL, VADR, ANY, TYPE
NAME:	<u>GETYPE</u>
FUNCTION:	Extracts the type from the left hand 2 bits of the 1st word and the left hand bit of the second word of the current symbol and places it in TYPE.
INPUT:	Clear AC.
OUTPUT:	Clear AC.
MAJOR REGISTERS CHANGED:	TYPE.
NAME:	<u>TYPADD</u>
FUNCTION:	Change or add the type of the symbol pointed at by SADR.
INPUT:	Clear AC.
OUTPUT:	Clear AC.
MAJOR REGISTERS CHANGED:	TYPE, 1st 2 words of symbol table entry.

Symbol Table Routines (cont.)

NAME: CURREN

FUNCTION: Handles the special character ", ". It defines the symbol preceding the comma as equal to the current address counter.

INPUT: Clear AC.

OUTPUT: Clear AC.

MAJOR REGISTERS CHANGED: TEM1A-TEM1A+2, VADR, VAL1A

NAME: ENTS

FUNCTION: Enter a symbol in the symbol table with type equal to the parameter following the call. The symbol to be entered is in TEM1-TEM3 and the value in VAL.

INPUT: Clear AC.

OUTPUT: Clear AC.

MAJOR REGISTERS CHANGED: SEND, SADR, VADR, TYPE.

NAME: ERR7

FUNCTION: This routine is called by CURREN to determine whether the symbol to be defined has already been defined and, if so, whether the new definition agrees with the old.

Symbol Table Routines (cont.)

INPUT: Clear AC.

OUTPUT: Clear AC.

MAJOR REGISTERS CHANGED: None.

NAME: SAVE

FUNCTION: Called by SEARCH to save the pointers (SADR, TYPE, VADR) of the previous symbol, in case the current symbol is a definition character ( , or =) or a macro escape character.

INPUT: Clear AC.

OUTPUT: Clear AC.

MAJOR REGISTERS CHANGED: REPUN, RESTOR-1, VADR1

NAME: RESTOR

FUNCTION: Restores the registers saved by SAVE. CURREN, the "," processing routine, is one place where RESTOR is called to allow definition of the symbol preceding the ",".

INPUT: Clear AC.

OUTPUT: Clear AC.

Symbol Table Routines (cont.)

MAJOR REGISTERS CHANGED: SADR, TYPE, VADR

NAME: LDT

FUNCTION: Used in the assembling of a symbol. If the character is alphanumeric, exit is made with it in the AC after having incremented IN and called IDX for the next character. If non-alphanumeric, CHARX is cleared to effect immediate exit from LDT in subsequent calls.

INPUT: Clear AC.

OUTPUT: Alphanumeric character of 0 in AC.

MAJOR REGISTERS CHANGED: NUPAGE (for temporary storage),  
IN -- alphanumeric character  
counter, CHARX.

NAME: ALW

FUNCTION: Used in the assembling of a symbol. It makes two calls to LDT and adds the output of the 2nd to 45<sub>8</sub> times the 1st. This gains type bits in the 1st two words of the symbol table entry.

INPUT: Clear AC.

Symbol Table Routines (cont.)

OUTPUT: Word of symbol in AC.

MAJOR REGISTERS CHANGED: NUPAGE (for temporary storage), VAL.

NAME: AAS

FUNCTION: Assembles a 3 word symbol by calling  
ALW three times. By calls to LDT,  
it causes all letter/digits beyond 6  
to be ignored.

INPUT: Clear AC.

OUTPUT: Clear AC.

MAJOR REGISTERS CHANGED: TEM1, TEM2, TEM3.

NAME: ANY

FUNCTION: Control comes here from the SEARCH  
routine. If the type of the symbol  
found is defined or undefined, ANY is  
indexed to indicate something valid  
was assembled for this line.

INPUT: Clear AC.

OUTPUT: Clear AC.

MAJOR REGISTERS CHANGED: ANY

Symbol Table Routines (cont.)

NAME: GETASY

FUNCTION: Calls AAS to get a symbol and then SEARCH to see if it is already in the symbol table. If it is not in the table, it is entered as undefined by calling ENTS.

INPUT: Non-zero AC when called by GETSYM; otherwise clear AC.

OUTPUT: Non-zero AC if symbol undefined and pass is 1; otherwise clear AC.

MAJOR REGISTERS CHANGED: IN, VAL, TRUBL.

NAME: TRIPLE

FUNCTION: Triple precision comparison routine used by ALPHA to order its output. It exits with the link on if the symbol in WORK-WORK+2 is greater than the symbol in TEM1 - TEM1+2.

INPUT: Clear AC.

OUTPUT: Clear AC; link on or off.

MAJOR REGISTERS CHANGED: MOVE (for temporary storage)



Symbol Table Routines (cont.)

NAME:	<u>GETADR</u>
FUNCTION:	Called by EXPR when a defined or undefined symbol is terminated by a space. Its job is to get the address portion of this expression. Because it calls EXPR to accomplish this, it must save its own exit point for possible recursion. It will call CONC to generate a link when the address is an out-of-page reference.
INPUT:	Clear AC.
OUTPUT:	Clear AC.
MAJOR REGISTERS CHANGED:	ADR, NUPAGE (for temporary storage).

7. Numeric Routines

NAME:	<u>DECIMS</u>
FUNCTION:	Sets a switch in MT10 to effect decimal radix for all subsequent numbers.
INPUT:	Clear AC.
OUTPUT:	Clear AC.
MAJOR REGISTERS CHANGED:	MTSW (the switch address).

Numeric Routines (cont.)

NAME: OCTS

FUNCTION: Sets a switch in MT10 to effect octal radix for all subsequent numbers.

INPUT: Clear AC.

OUTPUT: Clear AC.

MAJOR REGISTERS CHANGED: MTSW (the switch address).

NAME: MT10

FUNCTION: Uses calls to MTRL (which shifts LWC left 1 place) and calls to MTAD (which adds the contents of TIC to the pseudo accumulator, LWC) to combine the number in MTDG, according to the currently declared radix, with the previously accumulated value, LWC.

INPUT: Clear AC.

OUTPUT: Clear AC.

MAJOR REGISTERS CHANGED: TIC.

NAME: DRCV

FUNCTION: Numeric input and conversion routine. It calls IDX for input and MT10 for conversion to the currently declared radix. A non-numeric character will stop processing.

Numeric Routines (cont.)

INPUT: Clear AC.

OUTPUT: AC non-zero.

MAJOR REGISTERS CHANGED: ANY, HIC, LWC, RTDIG, SIGN, DPN, MTDG.

8. Miscellaneous Routines

NAME: RADD

FUNCTION: Add the value in the AC to the accumulated value, CON, and store the result in CON.

INPUT: Value to be added to CON in AC.

OUTPUT: Clear AC.

MAJOR REGISTERS CHANGED: CON.

NAME: RSUB

FUNCTION: Subtract the value in the AC from the accumulated value, CON, and store the result in CON.

INPUT: Value to be subtracted from CON in AC.

OUTPUT: Clear AC.

MAJOR REGISTERS CHANGED: CON.

Miscellaneous Routines (cont.)

NAME: RAND

FUNCTION: AND the value in the AC with the accumulated value, CON, and store the result in CON.

INPUT: Value to be ANDed with CON in AC.

OUTPUT: Clear AC.

MAJOR REGISTERS CHANGED: CON.

NAME: RIOR

FUNCTION: OR the value in the AC with the accumulated value, CON, and store the result in CON.

INPUT: Value to be OR'd with CON in AC.

OUTPUT: Clear AC.

MAJOR REGISTERS CHANGED: CON, VAL (for temporary storage).

NAME: UNDERR

FUNCTION: Channels the error printout number, which is in the AC, to ERROR if the current pass is not 1. It suppresses error printouts during pass 1.

Miscellaneous Routines (cont.)

INPUT:	Error printout number in AC.
OUTPUT:	Pass 1 - error printout number in AC. Not Pass 1 - clear AC.
MAJOR REGISTERS CHANGED:	None.
NAME:	<u>PUSH2</u>
FUNCTION:	Enters the contents of the AC into the push down list.
INPUT:	Entry for push down list in AC.
OUTPUT:	Clear AC.
MAJOR REGISTERS CHANGED:	POINT, PACK (for temporary storage).
NAME:	<u>POPUP1</u>
FUNCTION:	Retrieves the last entry from push down list.
INPUT:	Clear AC.
OUTPUT:	Entry in AC.
MAJOR REGISTERS CHANGED:	POINT.

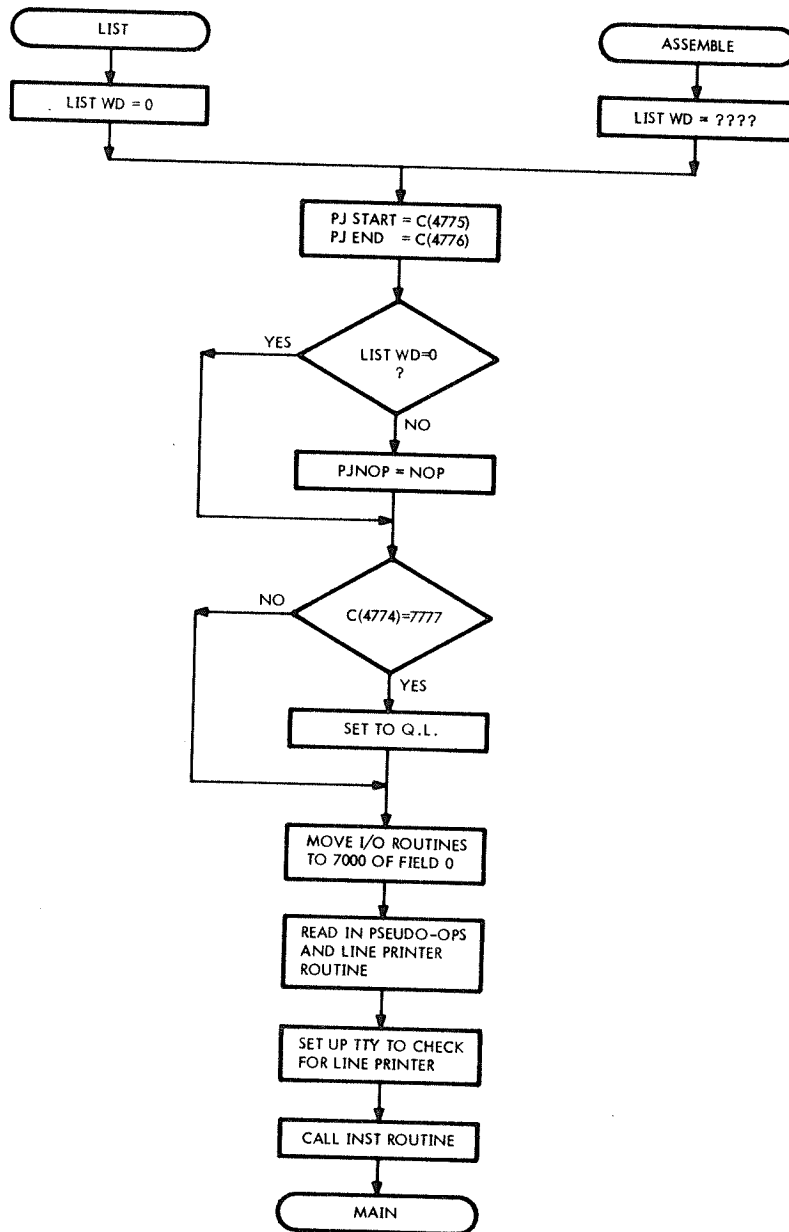

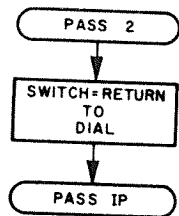
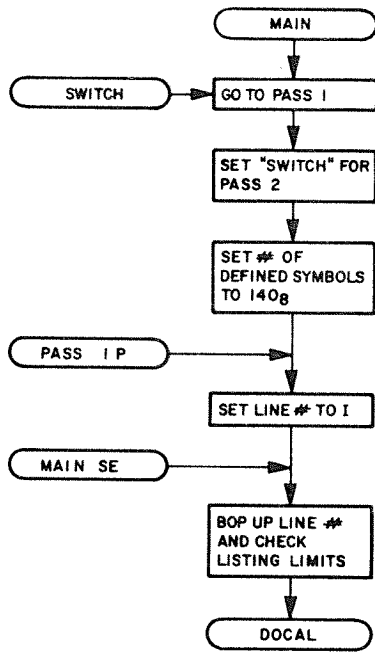

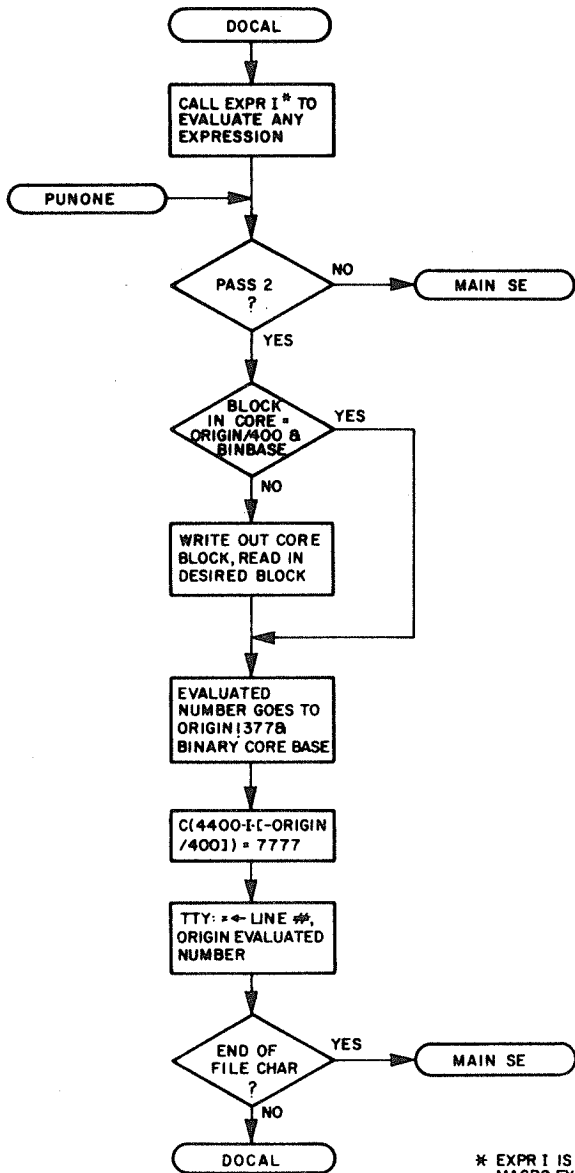

\* EXPR I IS THE MACRO-EXPRESSION EVALUATOR



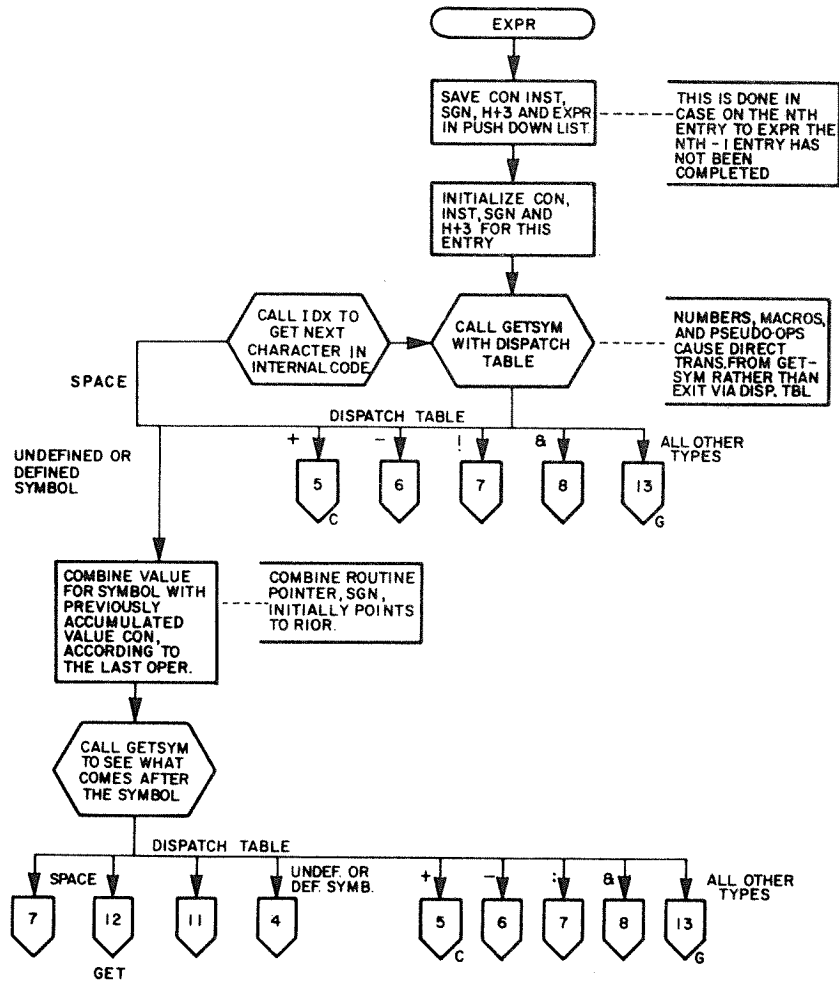

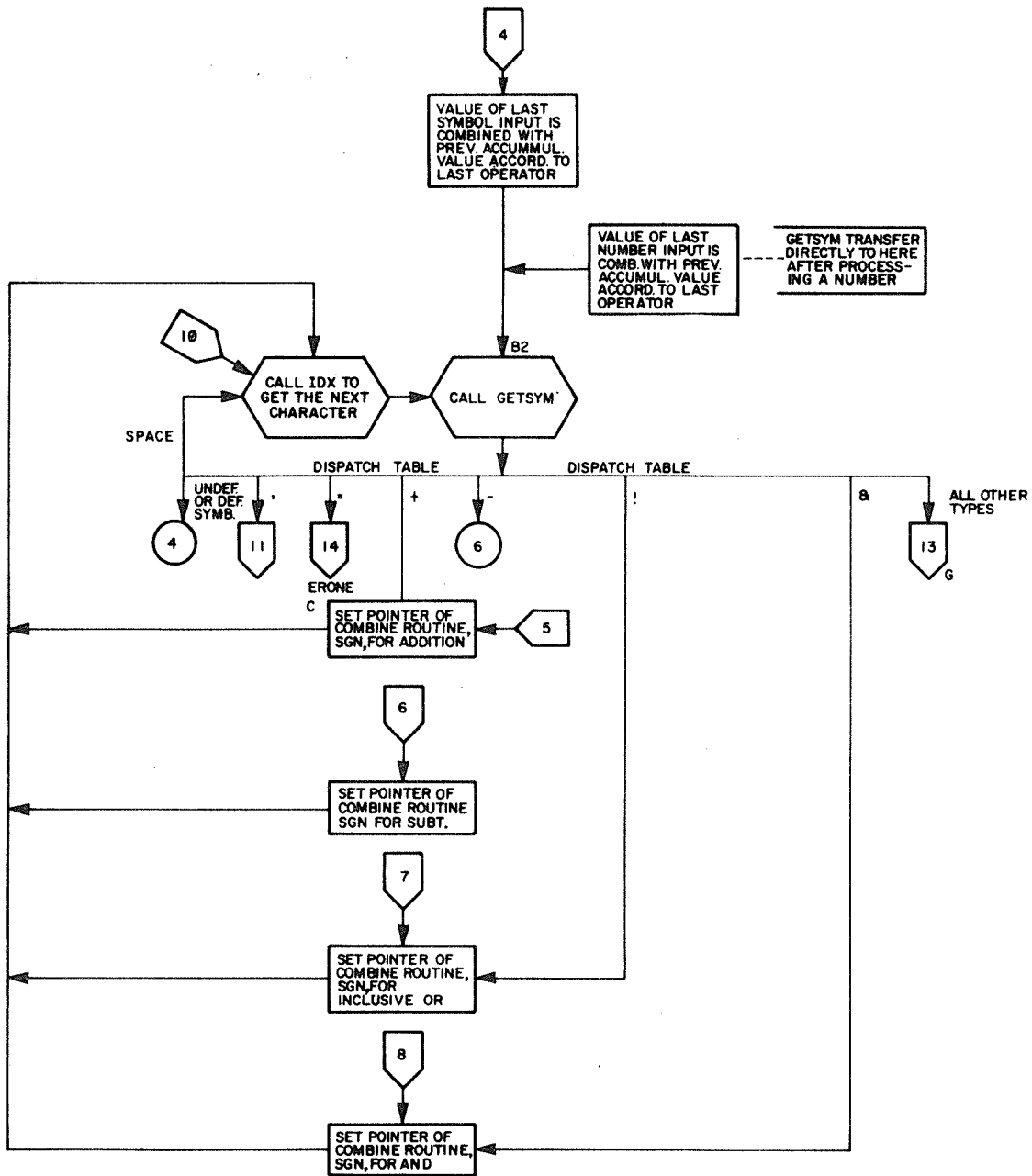

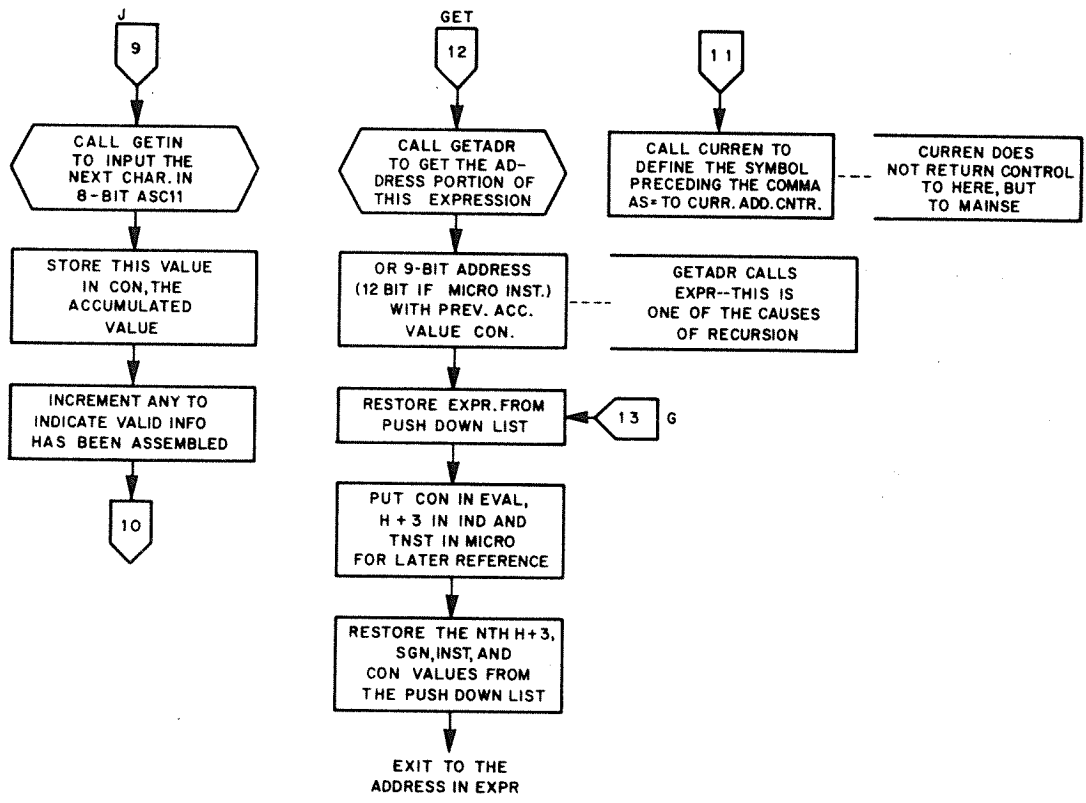

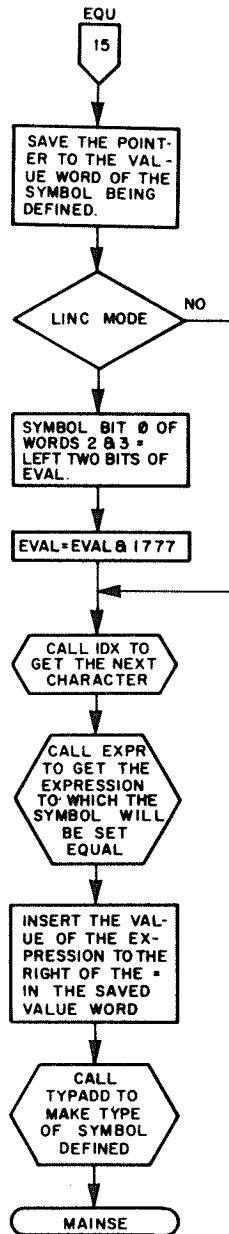
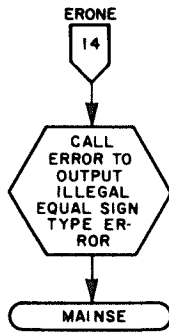

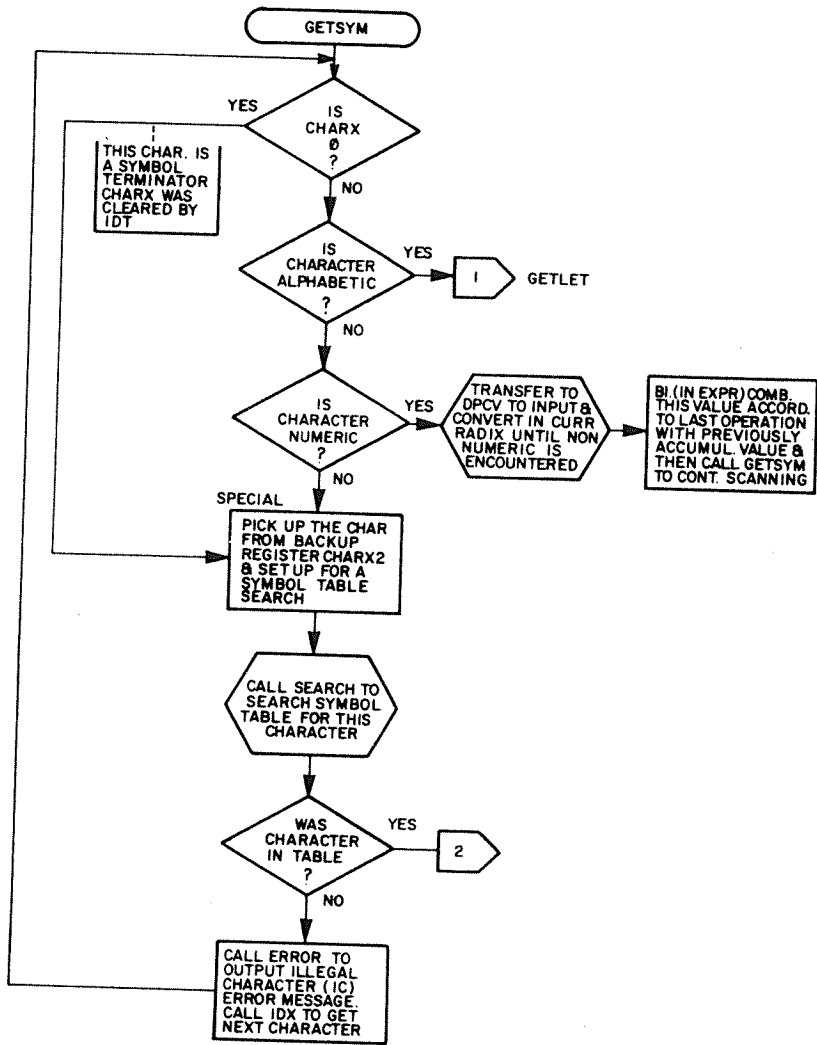

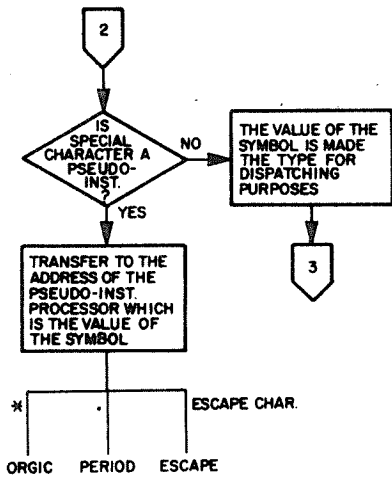

possibilities:  
 ~ :  
 a :  
 : SPACE

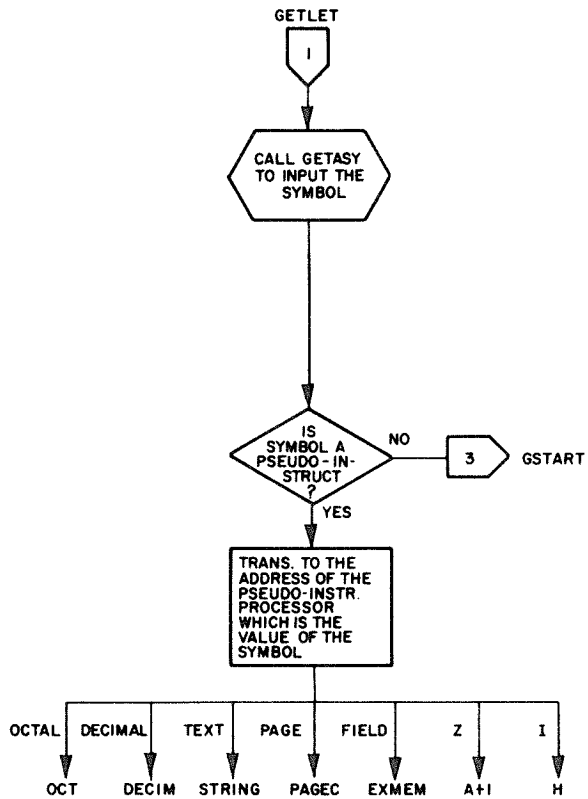

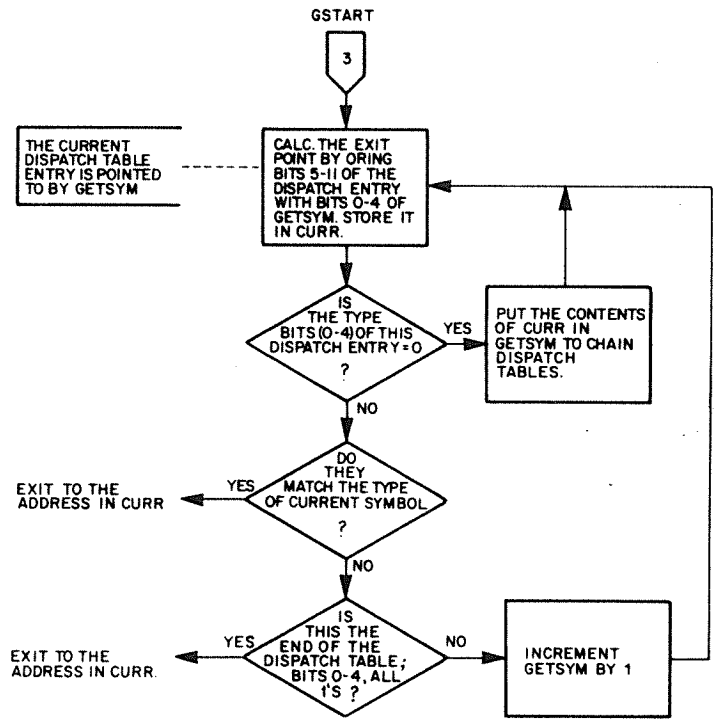

(DECOUT)

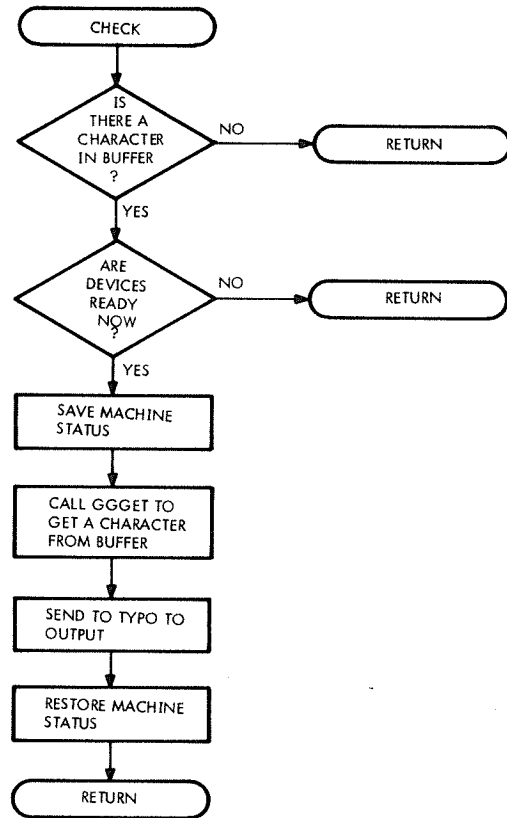
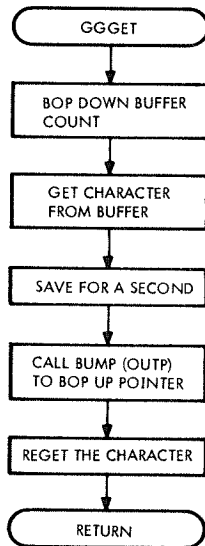
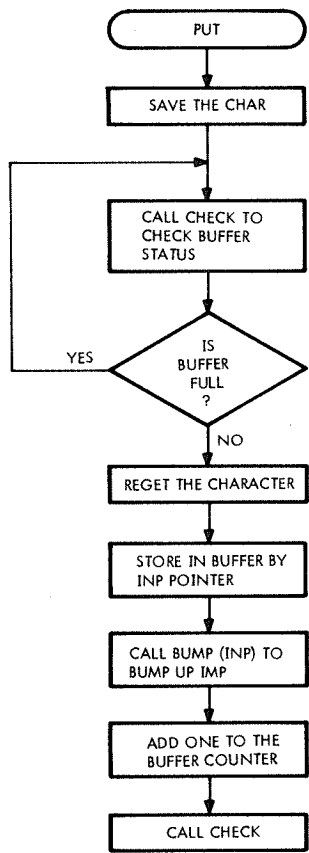



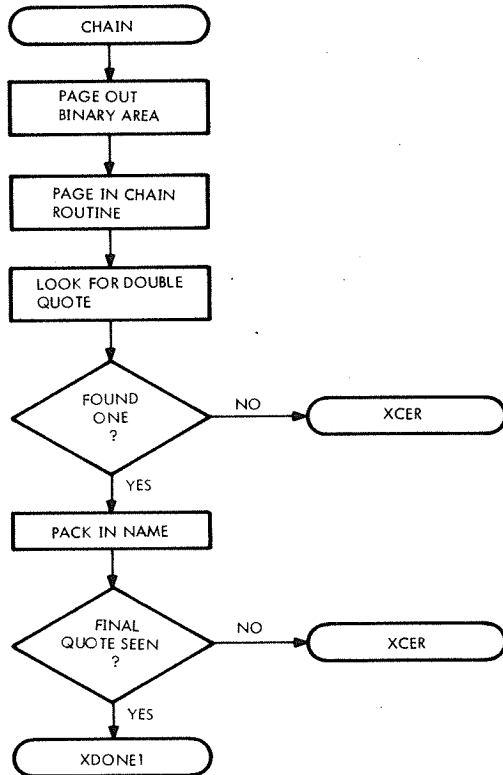
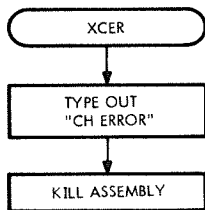
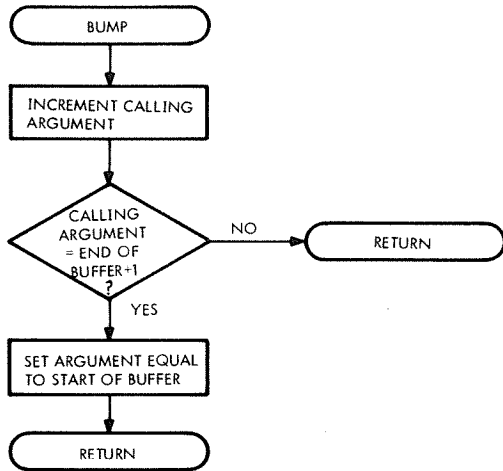

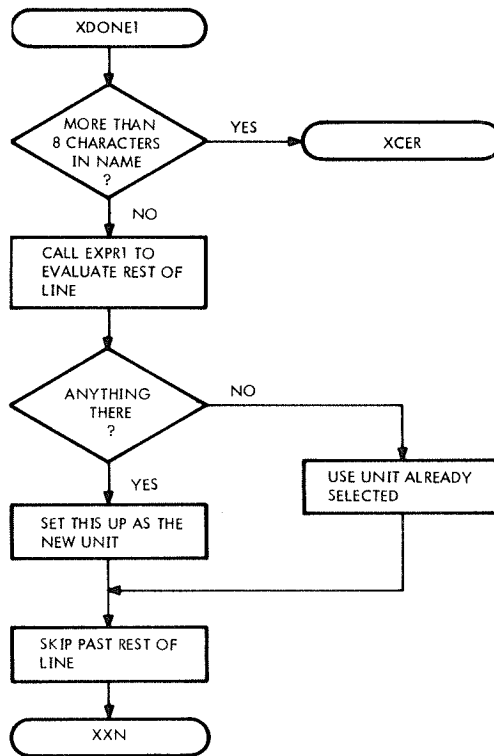
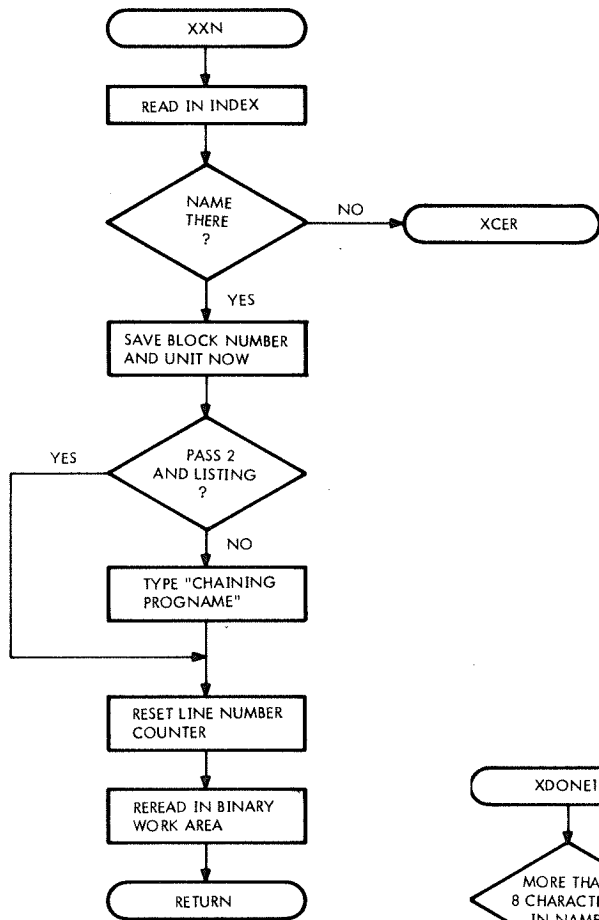

0005  
 0006  
 0007  
 0010  
 0011  
 0012  
 0013  
 0014  
 0015  
 0016  
 0017  
 0020  
 0021  
 0022  
 0023  
 0024  
 0025

D I A L A S S E M B L E R - - - V E R S I O N 2

/COPYRIGHT 1969, DIGITAL EQUIPMENT CORPORATION, MAYNARD MASSACHUSETTS, 01754  
 /PDP-12 DISK DIAL ASSEMBLER

THIS ASSEMBLER REQUIRES THE STANDARD DISK DIAL HARDWARE

LATEST ASSEMBLER <5/14/70>, INCLUDES CHAINING.

EJECT

internal code (at least that used by MACRO-8)

A-Z	1-32	\$	60
B-9	33-44	%	61
*	45	&	62
;	46	'	63
<	47	(	64
=	50	)	ignored
>	51	*	66
?	52	+	67
@	53	,	70
[	54	-	71
!	55	.	72
"	56	/	73
#	57	[	74
		\	75
		]	ignored

car.net . 46  
 tab 54

```

0026 //
0027 //
0030 //
0031 //
0032 //0000-0177 PAGE 0: COMMON LITERALS AND POINTERS,
0033 //0200-0377 BANK CHECK ROUTINE; SYMBOL SEARCH ROUTINE
0034 //0400-0577 SYMBOL TABLE GETTER ROUTINE
0035 //0600-0777 ROUTINE TO GET A SYMBOL FROM SYMBOL TABLE( OR ADD ON).
0036 // SOEC04 IS ACTIVE, SOEC08 IS NOT USED,
0037 // SOEC04 USES 6777-6000 FOR USER SYMBOLS,
0040 // 5400-5777 IS USED FOR USER SYMBOLS AND FOR A SWAPPING BUFFER/
0041 // IF MORE THEN 300 SYMBOLS . EXTRA SYMBOLS GO OUT ON UNIT 1,
0042 // GENERAL RECURSIVE EXPRESION EVALUATOR,
0043 // RECURSIVE ADDRESS EVALUATOR,
0044 //1000-1177 /CENTRAL PROCESSING LOOP, MAIN START OF ASSEMBLER AFTER INITIALIZATION.
0045 //1200-1377 /TEXT PROCESSOR,CURRENT LINE TESTER, PLUS MINOR SUPPORT ROUTINES.
0046 //1400-1577 AN INPUT CHARACTER SCANNER ROUTINE, THE PRINTER BUF ROUTINE, AND TAB ROUTINE.
0047 //1600-1777 NUMBER CONVERSIONS, TYPE CHECKS,
0050 //2200-2377 SYMBOL SORT FOR OUTPUT, TTY ROUTINE,
0051 //2400-2577 SYMBOL OUTPUT AND VALUE ROUTINE, OCTAL PRINT ROUTINE, FIELD CHANGE ROUTINE, AND WORK
//2600-2777 AREA,
0052 //3000-3177 OUTPUT LIST ROUTINE, 8K PSEUDO OP INITIALIZATION(DESTROYED AND NEVER USED), WORK AR
EA,
0053 //3200-3377 ERROR MESSAGE PROCESSOR, TYPE EVALUATOR, SYSTEM SYMBOL TABLE SWAPPER,
0054 // FAIRLY LOW LEVEL CHARACTER GETTER, AND ROUTINE TO SKIP IF NOT PASS2 OR NOT IN LIST M
ODE,
0055 //3400-3577 INPUT CHARACTER CONVERTOR TO INTERNAL FORM, PLUS PAGE CHECKERS, OTHER
0056 // LITTLE ROUTINES.
0057 //3600-3777 INTERNAL TO EXTERNAL CHARACTER CONVERTOR, SYMBOL TABLE TYPE GETTERS AND SETTERS,
0060 // LOW LEVEL CHARACTER GETTER, COMMENT PROCESSOR, LIST AND NOLIST PROCESSORS.
0061 //
0062 //THE FOLLOWING LOCATIONS ARE IN A S S E M B L E R !
0063 //
0064 //
0065 //4000-4177 GENERAL TAPE I/O CALL ROUTINES, INITILIAZTION FOR TAPE ROUTINES, PLUS EXTRA LITTLE
0066 // STUFF,
0067 //4200-4377 MORE TAPE I/O ROUTINES, PSEUDO OP PROCESSOR(FOR PAGED IN PSEUDO OPS), AND LOADER CO
RE MAP,
0070 //4400-4777 INPUT BUFFER*SWAPPED IN AND OUT WORK AREA FOR SAVSYM AND LODSYM,
0071 //5000-5377 OUTPUT BUFFER, PLUS INITIALIZATION FOR ENTIRE ASSEMBLER AFTER IT S FIRST LOADED IN
0072 // AND THIS ALSO CONTAINS THE SWAPPED IN PSEUDO OP PROCESSOR. NOTE: WHEN THINGS ARE SW
APPED IN,
0073 // THE PREVIOUS CONTENTS OF THE LOCATIONS ARE FIRST SWAPPED OUT TO PRESERVE THEM,
0074 //5400-5777 USER SYMBOLS IF < 300 SYMBOLS, ELSE IT S BUFFER AREA FOR SWAPPING SYMBOLS FROM TAP
1,
0075 //6000-6777 USER SYMBOLS(FIRST 200 OF THEM ANYWAY),
0076 //7000-7377 MODE SYMBOLS(EITHER PMODE OR LMODE TABLE, DEPENDING ON MODE,).
0077 //7400-7577 PSEUDO OP TABLE PLUS SPECIAL CHARACTER DEFINITION TABLE,
0100 //7600-7777 SUPPOSEDLY UNUSED, BUT WHEN PSEUDO OP TABLE IS LOADED, IT S LENGTH
// OF 400 WORDS OVERLAYS IT.
//
//
0104 //*****
0105 // E N D O F 4 K M A P
0106 //
0107 //
0110 //
0111 //
EJECT

```

```

0112 /
0113 /
0114 /
0115 /THIS MAP SHOWS ONLY CHANGES TO 4K MAP,
0116 /
0117 /
0120 /
0121 /
0122 /0600=0777
0123 /
/
0124 /5000=5377
0125 /5400=5777
0126 /6000=6177
0127 /6200=6377
0130 /6400=6777
0131 /7000=7377
/
0132 /7400=7777
0133 /
0134 /
0135 /
0136 /
0137 /
0140 /10000-16777
0141 /17000-17377
0142 /17400-17577
0143 /
0144 /
0145 /
0146 /
0147 /
0150 /
0151 /
0152 /
-

```

B K L O A D E R M A P

THIS MAP SHOWS ONLY CHANGES TO 4K MAP,

SDECO8 IS NOW ACTIVE AND SDECO4 IS PASSIVE. SDECO8 USES THE UPPER 4K OF CORE FOR THE SYMBOL TABLE, THUS IT STORES NO USER SYMBOLS ON UNIT1(EXCEPT IF A SAVSYM IS GIVEN).

PSEUDO OP TABLE IS NO LONGER PAGED IN HERE, SEE 7000-7377, OVERLAPPED READ ROUTINES FOR READING WHILE CALCULATING, LINE PRINTER CHECKER AND BASIC LINE PRINTER ROUTINE, OVERLAPPED TAPE OUTPUT ROUTINES PLUS COMMON READ-WRITE ROUTINES, INPUT BUFFER NO .2 RESIDENT PSEUDO OP PROCESSOR, NOTE THAT IT CAN RESIDE IN TWO SEPERATE PAGES(FOR 4 OR 8K), INPUT BUFFER NO.1 FOR TAPE,

F I E L D 1 R E F E R E N C E S

USER DEFINED SYMBOLS,  
SYSTEM MODE SYMBOLS(LMODE OR PMODE),  
PSEUDO OPS AND SPECIAL CHARACTER TABLE,

E N D O F B K M A P

EJECT

```

0153 /
0154 /
0155 /
0156 /
0157 /
0160 /
      THE PSEUDO OP PROCESSOR IS A 400 LOCATION ROUTINE WHICH IS PAGED IN ON THE 4K MODE AND RESID
0161 ENT IN THE 8K MODE.
0162 /AFTER THE DESIRED PSEUDO OP IS FOUND IN THE TABLE BY "EXPR" IT THEN JMPS TO AN ISZ CHAIN
      /THE ISZ CHAIN IS A BUNCH OF SEQUENTIAL ISZ S OF LOCATION "OP1", AFTER FALLING THROUGH THE ISZ S OP1 CONTAI
0163 NS
      / THE DESIRED PSEUDO OP NUMBER, THE ROUTINE THEN PAGES IN THE PSEUDO OP PROCESSOR(IF 4K, ELSE IT S RESIDENT)
0164 , THEN JMS
      / TO IT WITH THE DESIRED OPERATION NUMBER IN THE AC, WHEN FINISHED THE PSEUDO OP PROCESSOR RETURNS AND IT S
      SWAPPED BAC
0165 /K OUT, IN THE 8K VERSION IT S RESIDENT AND IS NOT SWAPPED IN OR OUT.
0166 /
0167 /
0170 /
0171 /
0172 /
0173 EJECT

```

-

```

0174 /
0175 /
0176 /
0177 /
0200 /A SYMBOL TABLE ENTRY IS COMPOSED OF 4 WORDS, THE FIRST THREE ARE THE NAME AND THE LAST IS THE VALUE
0201 /IF THE SYMBOL IS A PSEUDO OP THEN THE LAST WORD CONTAINS A POINTER TO THE ROUTINE WHICH WILL PROCESS
0202 /THE PSEUDO OP AND THE REST OF THE STATEMENT.
0203 /
0204 /
0205 /THE NAME IS COMPOSED OF SIX CHARACTERS.
0206 /THESE CHARACTERS ARE USUALLY THE 26 LETTERS PLUS 10 NUMBERS PLUS A NULL CHARACTER IF LESS THEN 6 LETTERS LONG.
0207 /THIS GIVES YOU 45 OCTAL POSSIBLE CHARACTERS FOR THE LEFT OR THE RIGHT HALF OF A WORD.
0210 /IF YOU USE SIXBIT NOTATION, YOU LL WASTE 23 POSSIBLE POSITIONS ON THE CHARACTER. THEREFORE, SIXBIT IS NOT USED.
0211 /NOW, SINCE THE FIRST CHARACTER OF A NAME MUST BE A LETTER, THIS LEAVES ONLY 32 OCTAL
0212 /COMBINATIONS FOR THE FIRST CHARACTER. THUS IF WE MULTIPLY THE LEFT
0213 /CHARACTERS OF A WORD BY 45, WE WILL HAVE 2 FREE BITS IN THE FIRST WORD OF A NAME./
0214 /((32*45+45<2000 OCTAL), THESE TWO LEFT BITS ARE USED AS FOLLOWS:
0215 /
0216 /
0217 /
0220 /
0221 /
0222 /
0223 /
0224 /
0225 /
0226 /
0227 /

```

00:	SPECIAL CHARACTER
01:	UNDEFINED
10:	DEFINED
11:	PSEUDO OPERATION

EJECT

```

0230 /
0231 /
0232 /
0233 /
0234 /
0235 /          VERSION=17          /THIS IS USED IN CHECKING TAPE 1.
0236 /
0237 /
0240 /          /EVERY TIME YOU ASSEMBLE AND CHANGE THE MAJOR SYMBOL LOCATIONS, UP THIS BY 1.
0241 /
0242 /
0243 /
0244 /          UNITAS=4777          /PLACE TO GET UNIT FROM
0245 /          E7=0
0246 /          D6=300
0247 /          D7=370
0250 /          D8=410
0251 /          D9=446
0252 /          PTHREE=7325          /CLA CLL CML IAC RAL
0253 /          /GENERATES A +3 IN AC WHEN EXECUTED
0254 /          MTWO=7344          /CLA CLL CMA RAL
0255 /          /GENERATES A -2 IN AC WHEN EXECUTED,
0256 /          MTHREE=7346          /CLA CLL CMA RTL
0257 /          /GENERATES A -3 IN AC WHEN EXECUTED,
0260 /
0261 /
0262 /
0263 /
0264 /
0265 /          /SET TERM C TO 44 IF DOLLAR SIGN IS THE END OF FILE CHAR.
0266 /          TERMC=00
0267 /
0270 /
0271 /
0272 /
0273 /          EJECT

```



```

0274          /PDP-12 ASSEMBLER PAGE 0
0275          PMODE
0276          *1
0277          0001 0710 DECOUT, PUT
0300          0002 0000 ERTOT, 0
0301          0003 0000 LISTWD, 0
0302          0004 2353 CNTLPI, CNTRLP
0303          0005 0000 MICROB, 0
0304          0006 7777 EQRETI, 7777
0305          0007 0000 TEMP, 0
0306          /VARIABLES
0307          *10
0310          0010 2400 BINPTR, 2000+D7+10
0311          0011 0000 BINBLK, 0
0312          0012 0000 CURLIN, 0
0313          0013 7740 M40, -40
0314          0014 0000 TYPEA, 0
0315          0015 0011 P11, 11
0316          /16 AND 17 ARE USED
0317          /FOR AUTO-INDEXING,
0320          *20
0321          0020 0000 ANY, 0          /WAS THIS AN INSTRUCTION
0322          0021 0000 TYPE, 0        /HOLDS TYPE OF CURRENT SYMBOL
0323          0022 0000 VADR, 0        /VALUE OF CURRENT SYMBOL
0324          0023 0000 SADR, 0        /POINTER OF FIRST WORD OF CURRENT SYMBOL
0325          0024 0000 VAL, 0         /VALUE OF CURRENT SYMBOL
0326          0025 0000 VALK, 0
0327          0026 0000 SCURR, 0        /CURRENT SYMBOL NUMBER
0330          0027 0141 SEND, 141      /POINTER TO FIRST FREE REGISTER AFTER SYMBOL TABLE
0331          0030 0000 AADR, 0        /ACTUAL CURRENT ADDRESS
0332          0031 0000 APAGE, 0       /ORIGIN OF CURRENT PAGE - ACTUAL
0333          0032 0141 PERMA, 141     /FIRST REGISTER AFTER PERMANENT SYMBOL TABLE
0334          0033 0000 EVAL, 0        /HOLDS ADDRESS PORTION DURING CALCULATION
0335          0034 0000 SGN, 0
0336          0035 0000 PASS, 0        /7777 IF PASS 2
0337          0036 0000 FLOWD, 0       /7777 IF EXTENDED MEMORY
0340          0037 0000 MODE, 0       /7777 IF POP-8; 0 IF LINC
0341          0040 0000 TEM1A, 0
0342          0041 0000 0
0343          0042 0000 0
0344          0043 0000 CURR, 0
0345          0044 0000 CHARX, 0
0346          0045 0000 CHARX2, 0
0347          0046 0000 ABANK, 0
0350          0047 0000 POINT, 0       /PUSH DOWN LIST
0351          0050 0000 IN, 0          /TELLS WHETHER SYMBOL WAS ACCEPTED
0352          0051 0000 ITEM, 0
0353          0052 0000 HIC, 0
0354          0053 0000 LNC, 0
0355          0054 0000 MICROL, 0
0356          0055 0000 INST, 0       /- IF SYMBOLIC A MICRO INST.
0357          0056 0000 MICRO, 0
0360          0057 0000 CHARAC, 0
0361          0060 4013 INIT1, INIT
0362          /POINTERS
0363          0061 2054 EMPTY1, EMPTY
0364          0062 2661 SOPS, OPS
0365          0063 3663 RESE11, RESE1L
0366          0064 3400 BIT6A, BIT6
0367          0065 3355 PASSEK, PASSER
0370          0066 2520 CURSKA, CURSKP
0371          0067 3317 GETCHR, SYSIN
0372          0070 3524 CHEKER, PAGSET

```

0373	0071	1454	SYMLST,	LSTSYM
0374	0072	1400	MAINEX,	MAIN
0375	0073	1547	INAS,	CJMP1
0376	0074	0524	MOVE1,	MOVE8
0377	0075	0764	SKIP,	SKIP2
0400	0076	3201	ERR1,	ERROR
0401	0077	1000	EXPR1,	EXPR
0402	0100	2510	TYCARI,	TYCAR
0403	0101	1411	MAIN1,	MAINSE
0404	0102	1551	PAGE1,	RESET
0405	0103	1046	B21,	B2
0406	0104	2037	IDX1,	IDX
0407	0105	2341	PUSH1,	PUSH2
0410	0106	4307	POPU1,	POPUP1
0411	0107	0400	GETSY1,	GETSYM
0412	0110	3242	GETAS1,	GETASY
0413	0111	0622	TYPAD1,	TYPADD
0414	0112	0600	SDEC01,	SDEC08
0415	0113	4201	SRITIC,	SWRC
0416	0114	1503	SYB,	SYMBU
0417	0115	4275	SRD1,	SREAD1
0420	0116	4051	RET1,	RETURN
0421	0117	4101	MON,	MONIT
0422	0120	3001	PUNON1,	PUNONE
0423	0121	7000	M1000,	-1000
0424	0122	7735	M43,	-43
0425	0123	7745	M33,	-33
0426	0124	0400	P400,	400
0427	0125	7733	M45,	-45
0430	0126	7711	M67,	-67
0431	0127	0076	P76,	76
0432	0130	1706	LINENO,	JBTEST
0433	0131	3777	P3777,	3777
0434	0132	2132	SCLEAR,	CLEARR
0435	0133	7731	M47,	-47
0436	0134	0240	P240,	240
0437	0135	7774	M4,	-4
0440	0136	6000	P6000,	6000
0441	0137	3662	PM60A,	M60A
0442	0140	0000	LOWTMP,	0
0443	0141	0740	PCHECK,	CHECK
0444	0142	5000	P5000,	5000
0445	0143	0300	P300,	300
0446	0144	1777	P1777,	1777
0447	0145	0177	P177,	177
0450	0146	7600	P7600,	7600
0451	0147	0200	P200,	200
0452	0150	4000	P4000,	4000
0453	0151	7563	M215,	-215
0454	0152	2000	P2000,	2000
0455	0153	0212	P212,	212
0456	0154	0215	P215,	215
0457	0155	7400	P7400,	7400
0460	0156	0777	P777,	777
0461	0157	0007	P7,	7
0462	0160	0077	P77,	77
0463	0161	0000	TEM1,	0
0464	0162	0000	TEM2,	0
0465	0163	0000	TEM3,	0
0466	0164	0000	CON,	0
0467	0165	0000	ADR,	0
0470	0166	0000	IND,	0
0471	0167	0000	ERRCNT,	0

/MAY BE USED ONLY FOR IMM, TEMP, NEVER USED IF YOU LEAVE ROUTINE.

/FIRST  
 /SECOND  
 /THIRD WORD OF CURRENT SYMBOL  
 /HOLDS ACCUMULATED VALUE OF WORD  
 /HOLD FULL 12 BIT ADDRESS  
 /400 IF INDIRECT OTHERWISE 0

0472	0170	0000	SWITCH, 0	
0473	0171	0000	SNUM, 0	
0474	0172	0000	EMPTRA, 0	
0475	0173	0000	SPCUNT, 0	/LINE CHARACTER SPACE COUNTER,
0476	0174	3102	SY, SYMBUF	
0477	0175	0000	TBCONT, 0	
0500	0176	2370	BINTAB, 2000+07	
0501	0177	4321	SETINU, UBITS	/POINTS TO THE ROUTINE TO TURN ON THE HEADER BLOCK BITS
0502			/	
0503			/	
0504			/	
0505			/	
0506			/	
0507			EJECT	

```

0510 /PDP-12 ASSEMBLER PAGE 1
0511 *200
0512 0200 4477 BANKCH, JMS I EXPR1
0513 0201 1020 TAD ANY
0514 0202 7640 SZA CLA
0515 0203 5220 JMP BANKEM
0516 0204 7040 CMA
0517 0205 1030 TAD AADR
0520 0206 1152 TAD P2000
0521 0207 0136 AND P6000
0522 0210 3030 DCA AADR
0523 0211 4463 BANKHR, JMS I RESET1
0524 0212 4502 JMS I PAGE1
0525 0213 1030 TAD AADR
0526 0214 3033 DCA EVAL
0527 0215 4465 JMS I PASSEK
0530 0216 4466 JMS I CURSKA
0531 0217 5501 JMP I MAIN1
0532 0220 7307 BANKEM, CLA CLL IAC RTL
0533 0221 0033 AND EVAL
0534 0222 3036 DCA FLOWD
0535 0223 1033 TAD EVAL
0536 0224 7012 RTR
0537 0225 7010 RAR
0540 0226 5207 JMP BANKHR-2
0541 /
0542 0227 0000 CURREN, 0
0543 0230 4663 JMS I RESTO1
0544 0231 2260 ISZ COMMAN
0545 0232 3171 DCA SNUM
0546 0233 4661 JMS I PSTCHK
0547 0234 4662 JMS I MOVEAA
0550 0235 1037 TAD MODE
0551 0236 7004 RAL
0552 0237 7200 CLA
0553 0240 1030 TAD AADR
0554 0241 7420 SNL
0555 0242 0144 AND P1777
0556 0243 6211 6211
0557 0244 3422 DCA I VADR
0560 0245 6201 6201
0561 0246 7430 S2L
0562 0247 5253 JMP PDP8ER
0563 0250 1030 TAD AADR
0564 0251 0136 AND P6000
0565 0252 7112 CLL RTR
0566 0253 1150 PDP8ER, TAD P4000
0567 0254 3256 DCA ,+2
0570 0255 4511 JMS I TYPAD1
0571 0256 0000 0
0572 0257 5664 JMP I MAIN1A
0573 /
0574 0260 7777 COMMAN, -1
0575 0261 3757 PSTCHK, STOCHK
0576 0262 2275 MOVEAA, ERR2
0577 0263 1751 RESTO1, RESTOR
0600 0264 1416 MAIN1A, MAINSF
0601 /
0602 0265 1736 SAVE1, SAVE
0603 /
0604 0266 0000 SEARCH, 0
0605 0267 4665 JMS I SAVE1
0606 0270 3026 DCA SCURR

```

/+4

/CHECK FOR TOO MANY COMMAS,  
/YEP, A BADDY

/PLACE SIGN BIT INTO THE LINK

/RESET IRREGULARLY,

*1 records the symbol table*  
*1 set symbol # = 0*

*Search starts at top  
of symbol table (#2600)  
and works down*

0607	0271	6211		6211
0610	0272	1026	SEARCH1,	TAD SCURR
0611	0273	4512		JMS I SDECO1
0612	0274	7240		CLA CMA
0613	0275	1023		TAD SADR
0614	0276	3016		DCA 16
0615	0277	1416		TAD I 16
0616	0300	0144		AND P1777
0617	0301	7041		CIA
0620	0302	1161		TAD TEM1
0621	0303	7640		SZA CLA
0622	0304	5370		JMP IND1
0623	0305	1416		TAD I 16
0624	0306	0131		AND P3777
0625	0307	7041		CIA
0626	0310	1162		TAD TEM2
0627	0311	7640		SZA CLA
0630	0312	5370		JMP IND1
0631	0313	1416		TAD I 16
0632	0314	0131		AND P3777
0633	0315	7041		CIA
0634	0316	1163		TAD TEM3
0635	0317	7640		SZA CLA
0636	0320	5370		JMP IND1
0637	0321	1367	TAD TOP	
0640	0322	7041		CIA
0641	0323	1023		TAD SADR
0642	0324	7700		SMA CLA
0643	0325	5334		JMP PSUD
0644	0326	1032		TAD PERMA
0645	0327	7041		CIA
0646	0330	1026		TAD SCURR
0647	0331	7510		SPA
0650	0332	3055		DCA INST
0651	0333	7300	PSUD,	CLA CLL
0652	0334	1416		TAD I 16
0653	0335	3025		DCA VALK
0654	0336	1016		TAD 16
0655	0337	3022		DCA VADR
0656	0340	7346		MTHREE
0657	0341	1016		TAD 16
0660	0342	3016		DCA 16
0661	0343	1416		TAD I 16
0662	0344	0150		AND P4000
0663	0345	3007		DCA TEMP
0664	0346	1416		TAD I 16
0665	0347	0150		AND P4000
0666	0350	7110		RAR CLL
0667	0351	1007		TAD TEMP
0670	0352	1025		TAD VALK
0671	0353	3024		DCA VAL
0672	0354	1037		TAD MODE
0673	0355	7700		SMA CLA
0674	0356	4764		JMS I IND1B
0675	0357	4765		JMS I GETYE
0676	0360	2266		ISZ SEARCH
0677	0361	4766		JMS I IND1C
0700	0362	6201	TAABA,	6201
0701	0363	5666		JMP I SEARCH
0702	0364	1560	IND1B,	LNINST
0703	0365	3623	GETYE,	GETYPE
0704	0366	2367	IND1C,	ANY
0705	0367	7374	TOP,	7374

*current symbol number*

*pointer to 15th word of current symbol*

*/NO MATCH.*

*if its loc is below 74100 then it's a perm. symb. If above, a pseudo*

*/- IF INSTRUCTION*

*PERMA = 141 = 141st symbol slot; => first symbol after permanent symbols.*

*get type of current symbol*

*/Return here if nothing assembled for this line  
/Return here if something found  
/like instruction does*

- 00 = special char*
- 01 = undefined*
- 10 = defined*
- 11 = pseudo-op*

0706	0370	2026	IN01,	ISZ SCURR
0707	0371	1026		TAD SCURR
0710	0372	7041		CIA
0711	0373	1027		TAD SEND
0712	0374	7640		SZA CLA
0713	0375	5272		JMP SEARC1
0714	0376	2020		ISZ ANY
0715	0377	5362		JMP TAABA
0716				EJECT

*increment symbol  
table pointer*

gets in the next item, whatever it is - a symbol, #, or character then displayed according to list following the call to this routine  
 / get 1st char.

```

0717 /POP-12 ASSEMBLER PAGE 2
0720 *400
0721 0400 0000 GETSYM, 0
0722 0401 1044 TAD CHARX
0723 0402 7450 SNA
0724 0403 5216 JMP SPECIAL
0725 0404 1123 TAD M33
0726 0405 7910 SPA
0727 0406 5241 JMP GETLET
0730 0407 1214 TAD M12A
0731 0410 7700 SNA CLA
0732 0411 5216 JMP SPECIAL
0733 0412 4615 JMS I DPCVOP
0734 0413 5634 JMP I B11
0735 0414 7766 M12A, -12
0736 0415 2200 DPCVOP, DPCV
0737 0416 1045 SPECIAL, TAD CHARX2
0740 0417 3163 DCA TEM3
0741 0420 3162 DCA TEM2
0742 0421 3161 DCA TEM1
0743 0422 4633 JMS I SCH1
0744 0423 5235 JMP B11+1
0745 0424 1021 TAD TYPE
0746 0425 1152 TAD P2000
0747 0426 7650 SNA CLA
0750 0427 5424 JMP I VAL
0751 0430 1024 TAD VAL
0752 0431 3021 DCA TYPE
0753 0432 5246 JMP GSTART
0754 0433 0266 SCH1, SEARCH
0755 0434 1041 B11, B1
0756 0435 7325 PTHREE
0757 0436 4476 JMS I ERR1
0760 0437 4504 JMS I IDX1
0761 0440 5201 JMP GETSYM+1
0762 0441 4510 GETLET, JMS I GETAS1
0763 0442 1021 TAD TYPE
0764 0443 1152 TAD P2000
0765 0444 7650 SNA CLA
0766 0445 5424 JMP I VAL
0767 0446 1600 GSTART, TAD I GETSYM
0770 0447 0145 AND P177
0771 0450 3043 DCA CURR
0772 0451 1200 TAD GETSYM
0773 0452 0146 AND P7600
0774 0453 1043 TAD CURR
0775 0454 3043 DCA CURR
0776 0455 1600 TAD I GETSYM
0777 0456 0146 AND P7600
1000 0457 7440 SZA
1001 0460 5264 JMP GTYPOT
1002 0461 1043 TAD CURR
1003 0462 3200 DCA GETSYM
1004 0463 5246 JMP GSTART
1005 0464 7041 GTYPOT, CIA
1006 0465 1021 TAD TYPE
1007 0466 7650 SNA CLA
1010 0467 5443 JMP I CURR
1011 0470 1600 TAD I GETSYM
1012 0471 0146 AND P7600
1013 0472 1147 TAD P200
1014 0473 7650 SNA CLA
1015 0474 5443 JMP I CURR
  
```

1st char = letter => symbol

/DIGIT

handle special characters here

call search routine

if TYPE = 0000 undefined

/GET SYMBOL

/PSEUDO OP,

at ~~branch~~ branch addr.

fix up ptr. to routine  
 get char. code

(i.e., new 15)

single exit so we go to new place of char code = 0

match what we have?

yes - go to correct service routine  
 get char code again

also go if this works out

to branch addr. / char. code  
 branch addr. offset  
 char. code

1016	0475	2507	ISZ	I	GETSY1
1017	0476	5246	JMP	G	START
1020	0477	4477	PAGEC,	JMS	I EXPR1
1021	0500	1020		TAD	ANY
1022	0501	7640		SZA	CLA
1023	0502	5316		JMP	PAGEM
1024	0503	7040		CMA	
1025	0504	1030		TAD	AADR
1026	0505	1147		TAD	P200
1027	0506	0146		AND	P7600
1030	0507	3030		DCA	AADR
1031	0510	4502	PAGHER,	JMS	I PAGE1
1032	0511	1030		TAD	AADR
1033	0512	3033		DCA	EVAL
1034	0513	4465		JMS	I PASSEK
1035	0514	4466		JMS	I CURSKA
1036	0515	5501		JMP	I MAIN1
1037	0516	1033	PAGEM,	TAD	EVAL
1040	0517	7012		RTR	
1041	0520	7012		RTR	
1042	0521	7012		RTR	
1043	0522	5306		JMP	PAGHER-2
1044	0523	7777	M1,-1		
1045	0524	0000	MOVEB,		
1046	0525	1323		TAD	M1
1047	0526	3016		DCA	16
1050	0527	7040		CMA	
1051	0530	1724		TAD	I MOVEB
1052	0531	3017		DCA	17
1053	0532	2324		ISZ	MOVEB
1054	0533	1724		TAD	I MOVEB
1055	0534	2324		ISZ	MOVEB
1056	0535	3345		DCA	MOVA
1057	0536	1156		TAD	P777
1060	0537	3007		DCA	TEMP
1061	0540	1007	MOV B,	TAD	TEMP
1062	0541	7124		CLL	CML RAL
1063	0542	3007		DCA	TEMP
1064	0543	7430		SZL	
1065	0544	5724		JMP	I MOVEB
1066	0545	0000	MOVA,		
1067	0546	1416		TAD	I 16
1070	0547	0007		AND	TEMP
1071	0550	0131		AND	P3777
1072	0551	6201			6201
1073	0552	3417		DCA	I 17
1074	0553	5340		JMP	MOV B
1075			/		
1076	0554	7610	DOLIST,	CLA	SKP
1077	0555	7240	PLIST,	CLA	CMA
1100	0556	3324		DCA	MOVEB
1101	0557	1035		TAD	PASS
1102	0560	7650		SNA	CLA
1103	0561	5367		JMP	DOPOUT
1104	0562	1324		TAD	MOVEB
1105	0563	3770		DCA	I JJSTART
1106	0564	1324		TAD	MOVEB
1107	0565	7040		CMA	
1110	0566	3771		DCA	I JJEND
1111	0567	5503	DOPOUT,	JMP	I B21
1112	0570	1733	JJSTART,		JSTART
1113	0571	1734	JJEND,	JEND	
1114			/		

*"page" pseudo-op*

/MULTIPLY BY 200

*Triple precision move routine?*

/LIST ENTRY PSEUDO,

/NOLIST PSEUDO,

/IN TEMPORARY,

/IS THIS PASS2?

/NO. IGNORE IT,

/B=L I ST,7777=NOL I ST

/FUDGE JBTEST PARAMS.

/SET UP LINE NUMBER LIMITS,

/CLEAN UP SYSTEM.



```

1115      /
1116      /
1117      /
1120      /
1121      /
1122      /
1123      /
1124      0572 0000 VRSTR, 0          /THIS ROUTINE RESTORE 6400 FROM THE SCRATCH AREA
1125      0573 4776          JMS I   VRSTRR /CALL THE READ ROUTINE
1126      0574 4331          VSAVE   /POINTER TO THE SAVE AREA
1127      0575 5772          JMP I   VRSTR  /RETURN TO THE CALLER
1130      /
1131      /
1132      /
1133      /
1134      0576 7774 VRSTRR, READ    /POINTER TO THE READ ROUTINE
1135      /
1136      /
1137      /
1140      /
1141      /
1142      /
1143      /
1144      /
1145      EJECT
-

```

```

1146 /PDP-12 ASSEMBLER PAGE 3
1147 *600
1150 /SYMBOL NUMBER DECODER
1151 0600 0000 S0EC08, 0
1152 0601 3171 DCA SNUM
1153 0602 1171 TAD SNUM
1154 0603 0136 AND P6000
1155 0604 7640 SZA CLA
1156 0605 5674 JMP I ERSY
1157 0606 1171 TAD SNUM
1160 0607 7106 CLL RTL
1161 0610 7041 CIA
1162 0611 1275 TAD STAB
1163 0612 3023 DCA SADR
1164 0613 7325 PTHREE
1165 0614 1023 TAD SADR
1166 0615 3022 DCA VADR
1167 0616 1360 TAD COUNT
1170 0617 7640 SZA CLA
1171 0620 4340 JMS CHECK
1172 0621 5600 JMP I S0EC08
1173 0622 0000 TYPADD, 0
1174 0623 7200 CLA
1175 0624 1622 TAD I TYPADD
1176 0625 3014 DCA TYPEA
1177 0626 1014 TAD TYPEA
1200 0627 3021 DCA TYPE
1201 0630 6211 6211
1202 0631 1423 TAD I SADR
1203 0632 0144 AND P1777
1204 0633 3423 DCA I SADR
1205 0634 1021 TAD TYPE
1206 0635 0136 AND P6000
1207 0636 1423 TAD I SADR
1210 0637 3423 DCA I SADR
1211 0640 2023 ISZ SADR
1212 0641 1423 TAD I SADR
1213 0642 0131 AND P3777
1214 0643 3423 DCA I SADR
1215 0644 1021 TAD TYPE
1216 0645 7006 RTL
1217 0646 0150 AND P4000
1220 0647 1423 TAD I SADR
1221 0650 3423 DCA I SADR
1222 0651 2023 ISZ SADR
1223 0652 1423 TAD I SADR
1224 0653 0131 AND P3777
1225 0654 3423 DCA I SADR
1226 0655 1021 TAD TYPE
1227 0656 7006 RTL
1230 0657 7004 RAL
1231 0660 0150 AND P4000
1232 0661 1423 TAD I SADR
1233 0662 3423 DCA I SADR
1234 0663 7344 MTWO
1235 0664 1023 TAD SADR
1236 0665 3023 DCA SADR
1237 0666 1021 TAD TYPE
1240 0667 0136 AND P6000
1241 0670 3021 DCA TYPE
1242 0671 6201 6201
1243 0672 2222 ISZ TYPADD
1244 0673 5622 JMP I TYPADD

```

```

/CONVERT A SYMBOL NUMBER TO AN ADDRESS
/SAVE THE NUMBER

```

/TOO MANY SYMS

```

/STAB IS TOP OF SYMBOL TABLE
/ADDRESS OF FIRST WORD OF SYMBOL

```

```

/POINTS TO SYMBOL VALUE
/GET THE NUMBER OF CHARACTERS IN THE OUTPUT BUFFER
/IF NON-ZERO, SEE IF ITS OK TO PRINT ONE,
/BY CALLING THE CHECK ROUTINE.

```

*changes type of symbol pointed to by SADR*

*change 1st word*

*change 2nd word*

*change 3rd word  
point back to 1st word*

1245	0674	1175	ERSY,STEXD				
1246	0675	7600	STAB,	7600			/SET TO POINT TO END OF THE SYMBOL TABLE
1247			/				
1250			/				
1251			/				
1252			/				
1253			/				
1254			/				
1255			/				
1256			/				
1257			/				
1260			/				
1261			/				
1262	0676	0000	GGGET,	0			BUFFERED TTY AND LPT ROUTINE
1263	0677	7240		CLA	CMA		/GETS A CHARACTER FROM THE BUFFER
1264	0700	1360		TAD		COUNT	/DECREMENT COUNT BY 1
1265	0701	3360		DCA		COUNT	
1266	0702	1705		TAD	I	OUTP	/GET THE CHARACTER
1267	0703	3140		DCA		LOWTMP	/SAVE FOR A SECOND
1270	0704	4326		JMS		BUMP	/BUMP THE RING POINTER NOW
1271	0705	6110	OUTP,	FIRST			/POINTS TO THE NEXT GET FROM SPOT IN THE BUFFER
1272	0706	1140		TAD		LOWTMP	/REGET THE CHARACTER
1273	0707	5676		JMP	I	GGGET	/AND EXIT
1274			/				
1275			/				
1276			/				
1277			/				
1300			/				
1301	0710	0000	PUT,	0			
1302	0711	3222		DCA		TYPADD	/SAVE THE CHAR IN ANOTHER TEMP LOC
1303	0712	4541		JMS	I	PCHECK	/CHECK TO STATUS OF THE DEVICES,
1304	0713	1360		TAD		COUNT	/GET THE COUNT
1305	0714	1361		TAD		PLTST	/COMPARE AGAINST THE MAXIMUM NUMBER ALLOWED
1306	0715	7650		SNA	CLA		
1307	0716	5312		JMP		PUT+2	/BUFFER IS FULL, WAIT
1310	0717	1222		TAD		TYPADD	/RECALL THE DESIRED CHARACTER
1311	0720	3722		DCA	I	INP	/STASH IN THE BUFFER
1312	0721	4326		JMS		BUMP	/BUMP THE BUFFER POINTER
1313	0722	6110	INP,	FIRST			/THE BUFFER POINTER
1314	0723	2360		ISZ		COUNT	/BOP UP THE COUNT
1315	0724	4541		JMS	I	PCHECK	/SEND OUT ANOTHER CHAR IF ALL IS WELL
1316	0725	5710		JMP	I	PUT	/AND EXIT
1317			/				
1320			/				
1321			/				
1322			/				
1323	0726	0000	BUMP,	0			/THIS BUMPS THE RING BUFFER POINTER
1324	0727	2726		ISZ	I	BUMP	
1325	0730	1726		TAD	I	BUMP	
1326	0731	1362		TAD		PLOVR	/TEST FOR WRAP AROUND
1327	0732	7650		SNA	CLA		/?
1330	0733	1361		TAD		PLTST	/GET MINUS END +START
1331	0734	1726		TAD	I	BUMP	/NOW READJUST POINTER IF NECESSARY
1332	0735	3726		DCA	I	BUMP	
1333	0736	2326		ISZ		BUMP	
1334	0737	5726		JMP	I	BUMP	
1335			/				
1336			/				
1337			/				
1340			/				
1341			/				
1342	0740	0000	CHECK,	0			/THIS CHECKS THE OUTPUT STATUS
1343	0741	1360		TAD		COUNT	/GET THE NUMBER OF CHARS IN THE BUFFER

1344	0742	7650	SNA CLA		
1345	0743	5740	JMP I	CHECK	/RETURN IF NO CHARS IN THE BUFFER
1346	0744	6041	TSF		/KEYBOARD OK???
1347	0745	5740	JMP I	CHECK	/NOPE, RETURN NOW
1350	0746	6661	LSD		/HOW ABOUT THE LINE PRINTER
1351	0747	5740	JMP I	CHECK	/IF NO LINE PRINTER THIS GETS ZAPPED
1352	0750	6214	RDF		/READ IN THE PRESENT DATA FIELD
1353	0751	1353	TAD	CCDF	/SAVE IT AWAY
1354	0752	3356	DCA	,+4	/SAVE IT AWAY FOR A SECOND
1355	0753	6201	CCDF,	0	/RESET THE DATA FIELD TO FIELD ZERO
1356	0754	4276	JMS	GGGET	/GET A CHAR FROM THE BUFFER
1357	0755	4763	JMS I	CTYPO	/NOW OUTPUT IT RIGHT AWAY,
1360	0756	0000	0000		/RETURN CDF GOES HERE
1361	0757	5740	JMP I	CHECK	/NOW RETURN TO THE CALLER
1362			/		
1363			/		
1364			/		
1365			/		
1366			/		
1367			/		
1370	0760	0000	COUNT,	0	/NUMBER OF CHARACTERS NOW IN THE BUFFER
1371	0761	7510	PLTST,	-BAD+FIRST	
1372	0762	1400	PLOVR,	-BAD	/-UPPER LIMIT
1373	0763	2527	CTYPO,	TYPO	/ADDRESS OF THE ACTUAL PUTTER
1374			/		
1375			/		
1376			/		
1377			/		
1400			/		
1401			/		
1402			/		
1403			/		
1404	0764	0000	SKIP2,	0	
1405	0765	3200	DCA	SDEC08	/SAVE SKIP COUNT
1406	0766	1134	TAD	P240	
1407	0767	4401	JMS I	DECOU	
1410	0770	2200	ISZ	SDEC08	
1411	0771	5366	JMP	,-3	
1412	0772	5764	JMP I	SKIP2	
1413			/		
1414			/		
1415			/		
1416			/		
1417			/		
1420			/		
1421			/		
1422			/		
1423			/		
1424			/		
1425			/		
1426			/		
1427	0773	0000	VPRSRV,	0	/THIS ROUTINE PRESERVES LOCATIONS 6400-67777
1430	0774	4777	JMS I	VPRSRW	/IN THE SCRATCH AREA, CALL THE WRITE ROUTINE
1431	0775	4331	VSAVE		
1432	0776	5773	JMP I	VPRSRV	/AND RETURN TO THE CALLER,
1433			/		
1434			/		
1435			/		
1436			/		
1437	0777	7775	VPRSRW,	WRITE	/POINTER TO THE WRITE ROUTINE,
1440			/		
1441			/		
1442			/		

1443  
1444  
1445  
1446  
1447  
1450  
1451  
1452  
1453  
-

/  
/  
/  
/  
/  
/  
/  
/  
/

EJECT

1454  
1455  
1456  
1457  
1460  
1461  
1462  
1463  
1464  
1465  
1466  
1467  
1470  
1471  
1472  
1473  
1474  
1475  
1476  
1477  
1500  
1501  
1502  
1503  
1504  
1505  
1506  
1507  
1510  
1511  
1512  
1513  
1514  
1515  
1516  
1517  
1520  
1521  
1522  
1523  
1524  
1525  
1526  
1527  
1530  
1531  
1532  
1533  
1534  
1535  
1536  
1537  
1540  
1541  
1542  
1543  
1544  
1545  
1546  
1547  
1550  
1551  
1552

```

*1000
SCOLON=200
COMMA=600
SYMB=4000
EQUALS=1400
USYMB=2000
EXCLAM=2200
ANDS=3400
PLUS=4600
MINUS=5200
SPACE=5600
ALL=7600
/PDP-12 ASSEMBLER PAGE 4
EXPR, 0
TAD CON
JMS I PUSH1
DCA CON
TAD INST
JMS I PUSH1
DCA INST
TAD MICROL
JMS I PUSH1
DCA MICROL
TAD SGN
JMS I PUSH1
TAD CRIOR
DCA SGN
TAD H6
JMS I PUSH1
DCA H6
TAD EXPR
JMS I PUSH1
SKP
A,
JMS I IDX1
JMS I GETSY1
B=1000+USYMB
B=1000+SYMB
A=1000+SPACE
C=1000+PLUS
C+3=1000+MINUS
C+5=1000+EXCLAM
G=1000+SCOLON
C+7=1000+ANDS
G=1000+ALL
TAD VAL
JMP ,+3
B1,
CLA
TAD LWC
JMS I SGN
SKP
B2,
JMS I IDX1
JMS I GETSY1
C+5=1000+SPACE
GET=1-1000+COMMA
B1=2-1000+SYMB
B1=2-1000+USYMB
ERONE=1000+EQUALS
A+5=1000
C,
TAD CRIOR+1
DCA SGN
JMP B2-1
TAD CRIOR+2
JMP C+1

```

*expression processor (recursive)*

*/save accumulated value*

*/save last operand address.*

*/OR - set up initially to do an IOR*

*/save indirect bit*

*/save exit*

*- /IE error*

*5B1 + Branch Addr + 761 + char code  
B - 1000 + USYMB*

1553	1062	1365	TAD CRIOR	/OR
1554	1063	5256	JMP C+1	
1555	1064	1370	TAD CRIOR+3	/AND
1556	1065	5256	JMP C+1	
1557	1066	1037	TAD MODE	
1560	1067	7700	SMA CLA	
1561	1070	5304	JMP LINK I	
1562	1071	1124	TAD P400	
1563	1072	1275	TAD H6	
1564	1073	3275	DCA H6	
1565	1074	5225	JMP A+1	
1566	1075	0000	H6, 0	
1567	1076	1024	B, TAD VAL	
1570	1077	4434	JMS I SGN	
1571	1100	4507	JMS I GETSY1	
1572	1101	1542	EQU-1000+EQUALS	
1573	1102	5710	GET-1000+SPACE	
1574	1103	0047	B2+1-1000	
1575	1104	1373	LINK I, TAD P10	
1576	1105	1373	UN, TAD P10	
1577	1106	5272	JMP H+4	
1600	1107	4774	JMS I DEFINI	
1601	1110	4772	GET, JMS I GETAD1	
1602	1111	1165	TAD ADR	
1603	1112	4765	JMS I CRIOR	
1604	1113	4506	G, JMS I POPU1	
1605	1114	3200	DCA EXPR	
1606	1115	1164	TAD CON	
1607	1116	3033	DCA EVAL	
1610	1117	1275	TAD H6	
1611	1120	3166	DCA IND	
1612	1121	4506	JMS I POPU1	
1613	1122	3275	DCA H6	
1614	1123	4506	JMS I POPU1	
1615	1124	3034	DCA SGN	
1616	1125	1054	TAD MICROL	
1617	1126	3005	DCA MICROB	
1620	1127	4506	JMS I POPU1	
1621	1130	3054	DCA MICROL	
1622	1131	1055	TAD INST	
1623	1132	3056	DCA MICRO	
1624	1133	4506	JMS I POPU1	
1625	1134	3055	DCA INST	
1626	1135	4506	JMS I POPU1	
1627	1136	3164	DCA CON	
1630	1137	5600	JMP I EXPR	
1631				
1632	1140	5741	ERONE, JMP I ,+1	
1633	1141	3766	EQUERR	
1634				
1635	1142	1771	EQU, TAD I REPUN1	
1636	1143	3364	DCA CRIOR-1	
1637	1144	3006	DCA EQRETI	
1640	1145	4504	JMS I IDX1	
1641	1146	4477	JMS I EXPR1	
1642	1147	7240	CLA CMA	
1643	1150	3006	DCA EQRETI	
1644	1151	1364	TAD CRIOR-1	
1645	1152	4512	JMS I SDECO1	
1646	1153	1033	TAD EVAL	
1647	1154	6211	6211	
1650	1155	3422	DCA I VADR	
1651	1156	6201	6201	

*check what follows a symbol*

*restore exit*

*restore indirect bit*

*restore last operator*

*same current symbol type*

*restore previous symbol type*

*routine to handle "="*

*SGN holds the address of the routine which handles the operation indicated by the last operator.*

1652	1157	4511	JMS I TYPAD1
1653	1160	4000	SYMB
1654	1161	4465	JMS I PASSEK
1655	1162	4466	JMS I CURSKA
1656	1163	5501	JMP I MAIN1
1657	1164	0000	0
1660	1165	1600	CR IOR, RIOR
1661	1166	4235	RADD
1662	1167	4211	RSUB
1663	1170	3713	RAND
1664	1171	1747	REPUN1, RESTOR-2
1665	1172	1200	GETAD1, GETADR
1666	1173	0010	PI0, 10
1667	1174	0227	DEFIN1, CURREN
1670	1175	1157	STEXD, TAD P7
1671	1176	4476	JMS I ERR1
1672	1177	5517	JMP I MON
1673			EJECT



```

1674
1675
1676      1200 0000
1677      1201 4504
1700      1202 1200
1701      1203 4505
1702      1204 4477
1703      1205 1037
1704      1206 7700
1705      1207 5250
1706      1210 1056
1707      1211 7700
1710      1212 5222
1711      1213 1164
1712      1214 7106
1713      1215 7006
1714      1216 0157
1715      1217 1261
1716      1220 7700
1717      1221 5257
1720      1222 1033
1721      1223 0146
1722      1224 7450
1723      1225 5242
1724      1226 7041
1725      1227 1031
1726      1230 7650
1727      1231 5241
1730      1232 7001
1731      1233 4662
1732      1234 5236
1733      1235 3165
1734      1236 4506
1735      1237 3200
1736      1240 5600
1737      1241 1147
1740      1242 3007
1741      1243 1033
1742      1244 0145
1743      1245 1007
1744      1246 1166
1745      1247 5235
1746      1250 1005
1747      1251 7700
1750      1252 5264
1751      1253 1033
1752      1254 0144
1753      1255 1166
1754      1256 3033
1755      1257 1033
1756      1260 5235
1757      1261 7772
1760      1262 2317
1761      1263 0000
1762      1264 1014
1763      1265 7006
1764      1266 0136
1765      1267 7640
1766      1270 5253
1767      1271 1033
1770      1272 1166
1771      1273 5256
1772      1274 0000

```

/PDP-12 ASSEMBLER PAGE 5

```

*1200
GETADR, 0
      JMS I IDX1
      TAD GETADR
      JMS I PUSH1
      JMS I EXPR1
      TAD MODE
      SMA CLA
      JMP LNKOR
      TAD MICRO
      SMA CLA
      JMP CHKLA
      TAD CON
      CLL RTL
      RTL
      AND P7
      TAD M6A
      SMA CLA
      JMP LEVEL+1
CHKLA, TAD EVAL
      AND P7600
      SNA
      JMP AWAY+1
      CIA
      TAD APAGE
      SNA CLA
      JMP AWAY
      IAC
      JMS I NUPAGE
      JMP LEAVE
      DCA ADR
LEAVE, JMS I POPU1
      DCA GETADR
      JMP I GETADR
      TAD P200
      DCA TEMP
      TAD EVAL
      AND P177
      TAD TEMP
      TAD IND
      JMP LEAVE-1
LNKOR, TAD MICROB
      SMA CLA
      JMP CHKL
      TAD EVAL
      AND P1777
      TAD IND
      DCA EVAL
LEVEL, TAD EVAL
      JMP LEAVE-1
M6A, -6
NUPAGE, UNDERR
      0
CHKL, TAD TYPEA
      RTL
      AND P6000
      SZA CLA
      JMP LEVEL-3
      TAD EVAL
      TAD IND
      JMP LEVEL
LDT, 0

```

*assembles address portion of word*

*1st expansion for address*

*if inc mode*

*if page 0*

*if error*

*restore exit*

*assemble addr.*

*if not MRI*

*check if line mode def.*

*if yes, LINE MODE  
if not, LINE MODE*

*TAD TYPEA  
AND P 1400  
SZA CLA*

1773	1275	1044	TAD CHARX
1774	1276	7450	SNA
1775	1277	5674	JMP I LDT
1776	1300	3263	DCA NUPAGE+1
1777	1301	1263	TAD NUPAGE+1
2000	1302	1125	TAD M45
2001	1303	7700	SMA CLA
2002	1304	5311	JMP NOTLDT
2003	1305	2050	ISZ IN /LETTER OR DIGIT
2004	1306	4504	JMS I IDX1
2005	1307	1263	TAD NUPAGE+1
2006	1310	5674	JMP I LDT
2007	1311	3044	NOTLDT, DCA CHARX
2010	1312	5674	JMP I LDT
2011	1313	0000	A1W, 0
2012	1314	4274	JMS LDT
2013	1315	3263	DCA NUPAGE+1
2014	1316	1263	TAD NUPAGE+1
2015	1317	7106	CLL RTL
2016	1320	3024	DCA VAL /CHR, *4
2017	1321	1024	TAD VAL
2020	1322	7006	RTL
2021	1323	7004	RAL /CHR, *32
2022	1324	1024	TAD VAL
2023	1325	1263	TAD NUPAGE+1 /CHR *1
2024	1326	3024	DCA VAL
2025	1327	4274	JMS LDT
2026	1330	1024	TAD VAL
2027	1331	5713	JMP I A1W
2030	1332	0000	AAS, 0
2031	1333	4313	JMS A1W
2032	1334	3161	DCA TEM1
2033	1335	4313	JMS A1W
2034	1336	3162	DCA TEM2
2035	1337	4313	JMS A1W
2036	1340	3163	DCA TEM3
2037	1341	4274	JMS LDT
2040	1342	7050	SNA CLA
2041	1343	5732	JMP I AAS
2042	1344	5341	JMP , -3
2043	1345	4504	ORGIC, JMS I IDX1
2044	1346	4477	JMS I EXPR1
2045	1347	1037	TAD MODE
2046	1350	7700	SMA CLA
2047	1351	5370	JMP LINKIC
2050	1352	1033	TAD EVAL
2051	1353	3030	DCA AADR
2052	1354	1033	TAD EVAL
2053	1355	0146	AND P7600
2054	1356	7041	CIA
2055	1357	1031	TAD APAGE
2056	1360	7650	SNA CLA
2057	1361	5365	JMP LNRT
2060	1362	4502	JMS I PAGE1
2061	1363	1030	TAD AADR
2062	1364	3033	DCA EVAL
2063	1365	4465	LNRT, JMS I PASSEK
2064	1366	4466	JMS I CURSKA
2065	1367	5501	JMP I MAIN1
2066	1370	1033	LINKIC, TAD EVAL
2067	1371	0144	AND P1777
2070	1372	1046	TAD ABANK
2071	1373	3030	DCA AADR

*Handwritten notes:*  
 1340-1343  
 1344-1345  
 "X"

2072  
2073  
-

1374 5365

JMP LNRT  
EJECT

2074  
2075  
2076  
2077  
2100  
2101  
2102  
2103  
2104  
2105  
2106  
2107  
2110  
2111  
2112  
2113  
2114  
2115  
2116  
2117  
2120  
2121  
2122  
2123  
2124  
2125  
2126  
2127  
2130  
2131  
2132  
2133  
2134  
2135  
2136  
2137  
2140

/

END OF ASSEMBLY!!!!!!!!!!!!

CHAIN "ASSEM2" /GO GET THE SECOND PART NOW,

0000 \*20  
0001 PHODE  
0002 /  
0003 /  
0004 /  
0005 /  
0006 /  
0007 /  
0010 /  
0011 /  
0012 /  
0013 /  
0014 /  
0015 /  
0016 /  
0017 BEGINNING OF ASSETHO.  
0020 /  
0021 /  
0022 /  
0023 /  
0024 /  
0025 /  
0026 /  
0027 /  
0030 /

0031  
0032  
0033  
0034  
0035  
0036  
0037  
0040  
0041  
0042  
-

/  
/  
/  
/  
/  
/  
/  
/  
/  
/  
/

EJECT

```

0043 /
0044 /
0045 /
0046 /
0047 /
0050 /PDP-12 ASSEMBLER PAGE 6
0051 /
0052 /
0053 / *1400
0054 1400 5201 MAIN, JMP PASS1
0055 1401 1032 PASS1, TAD PERMA
0056 1402 3027 DCA SEND
0057 1403 3035 DCA PASS
0060 1404 3037 DCA MODE
0061 1405 4320 JMS SETORG
0062 1406 1350 TAD CJMP1+1
0063 1407 3200 PASS1P, DCA MAIN
0064 1410 4735 JMS I OCTS1
0065 1411 4530 MAINSE, JMS I LINENO
0066 1412 7240 CLA CMA
0067 1413 3777 DCA I PTOCHC
0070 1414 4404 JMS I CNTLPI
0071 1415 4653 JMS I CLENUP
0072 1416 4504 MAINSF, JMS I IDX1
0073 1417 1376 TAD M60
0074 1420 3173 DCA SPCUNT
0075 1421 1357 TAD LIST1
0076 1422 3047 DCA POINT
0077 1423 3020 DCA ANY
0100 1424 3166 DCA IND
0101 1425 5775 JMP I PSINTER
0102 1426 4477 DOCAL, JMS I EXPR1
0103 1427 1020 TAD ANY
0104 1430 7650 SNA CLA
0105 1431 5304 JMP MAINSA
0106 1432 1033 TAD EVAL
0107 1433 4236 JMS ONEREG
0110 1434 4461 TACK, JMS I EMPTY1
0111 1435 5211 JMP MAINSE
0112 1436 0000 ONEREG, 0
0113 1437 3033 DCA EVAL
0114 1440 4520 JMS I PUNON1
0115 1441 2030 ISZ AADR
0116 1442 1037 TAD MODE
0117 1443 7700 SMA CLA
0120 1444 5252 JMP LNKREG
0121 1445 1030 TAD AADR
0122 1446 0145 AND P177
0123 1447 7640 SZA CLA
0124 1450 5636 JMP I ONEREG
0125 1451 4502 JMS I PAGE1
0126 1452 5636 LNKREG, JMP I ONEREG
0127 1453 2132 CLENUP, CLEARR
0130 /SYMBOLIC ASSEMBLY SAVE ROUTINE
0131 1454 0000 LSTSYM, 0
0132 1455 1003 TAD LISTWD
0133 1456 7710 SPA CLA
0134 1457 5654 JMP I LSTSYM
0135 1460 1051 TAD ITEM
0136 1461 1122 TAD M43
0137 1462 7650 SNA CLA
0140 1463 5654 JMP I LSTSYM
0141 1464 1051 TAD ITEM

```

/SWITCH  
*1 case all but perm. syms.*

/SET TADIX TO OCTAL

/RESET THE COMMA SWITCH,

*main loop, passed thru  
each time a terminator  
found.*

/NOTHING TO BE ASSEMBLED

*1 output one word (bin)*

/END OF PAGE

0142	1465	2356		ISZ SWOT
0143	1466	5274		JMP DOLEFT
0144	1467	1703		TAD I SYMBU
0145	1470	3703		DCA I SYMBU
0146	1471	2303		ISZ SYMBU
0147	1472	2057	LSRTE,	ISZ CHARAC
0150	1473	5654		JMP I LSTSYM
0151	1474	7106	DOLEFT,	CLL RTL
0152	1475	7006		RTL
0153	1476	7006		RTL
0154	1477	3703		DCA I SYMBU
0155	1500	7040		CMA
0156	1501	3356		DCA SWOT
0157	1502	5272		JMP LSRTE
0160	1503	3102	SYMBU,	SYMBUF
0161	1504	1035	MAINSA,	TAD PASS
0162	1505	7650		SNA CLA
0163	1506	5211		JMP MAINSE
0164	1507	1003		TAD LISTWD
0165	1510	7710		SPA CLA
0166	1511	5211		JMP MAINSE
0167	1512	1167		TAD ERRCNT
0170	1513	7640		SZA CLA
0171	1514	5234		JMP TACK
0172	1515	4465		JMS I PASSEK
0173	1516	4466		JMS I CURSKA
0174	1517	5211		JMP MAINSE
0175	1520	0000	SETORG,	0
0176	1521	1150		TAD P4000
0177	1522	3030		DCA AADR
0200	1523	1150		TAD P4000
0201	1524	3031		DCA APAGE
0202	1525	1150		TAD P4000
0203	1526	3033		DCA EVAL
0204	1527	1150		TAD P4000
0205	1530	3046		DCA ABANK
0206	1531	3002		DCA ERTOT
0207	1532	3036		DCA FLOWD
0210	1533	3167		DCA ERRCNT
0211	1534	5720		JMP I SETORG
0212	1535	2235	OCTS1,	OCTS
0213	1536	3002		PUNONE+1
0214	1537	7240	PASS2,	CLA CMA
0215	1540	3035		DCA PASS
0216	1541	1121		TAD H1000
0217	1542	3736		DCA I OCTS1+1
0220	1543	4320		JMS SETORG
0221	1544	4460		JMS I INIT1
0222	1545	1347		TAD CJMP1
0223	1546	5207		JMP PASS1P
0224	1547	5201	CJMP1,	JMP PASS1
0225	1550	5337		JMP PASS2
0226	1551	0000	RESET,	0
0227	1552	1030		TAD AADR
0230	1553	0146		AND P7600
0231	1554	3031		DCA APAGE
0232	1555	5751		JMP I RESET
0233	1556	0000	SWOT,	0
0234	1557	2731	LIST1,	LISTA
0235	1560	0000	LNINST,	0
0236	1561	1055		TAD INST
0237	1562	7700		SMA CLA
0240	1563	5372		JMP .+7

*Initialize origins*

*Set up for pass 2*

*1 sic if symbol is perm. or user  
Luser*



0241	1564	1024	TAD	VAL
0242	1565	0136	AND	P6000
0243	1566	7650	SNA	CLA
0244	1567	5372	JMP	,+3
0245	1570	7040	CMA	
0246	1571	3054	DCA	MICROL
0247	1572	1025	TAD	VALK
0250	1573	3024	DCA	VAL
0251	1574	5760	JMP	I LNINST
0252	1575	1426	PS INTER, DOCAL	
0253	1576	7716	M60,	-62
0254	1577	0260	PTOCMC, COMMAN	
0255			/	
0256			/	
0257			/	
0260			EJECT	

*Instruction*

*set value of symbol*

```

/PDP-12 ASSEMBLER PAGE 7
*1600
0261      1600 0000  RIOR, 0
0262      1601 3024      DCA  VAL
0263      1602 1164      TAD  CON
0264      1603 7040      CMA
0265      1604 0024      AND  VAL
0266      1605 1164      TAD  CON
0267      1606 3164      DCA  CON
0270      1607 5600      JMP I RIOR
0271
0272
0273
0274      /
0275      1610 4703  STRING, JMS I  GENINI
0276      1611 7041      CIA
0277      1612 3024      DCA  VAL
0300      1613 4241      JMS  STGET
0301      1614 5273      JMP  STNODUMP
0302      1615 5224      JMP  STINTO
0303      1616 4241  STLOOP, JMS  STGET
0304      1617 5267      JMP  STDUMP
0305      1620 1033      TAD  EVAL
0306      1621 4704      JMS I  ONEREI
0307      1622 4465      JMS I  PASSEK
0310      1623 4500      JMS I  TYCARI
0311      1624 1051  STINTO, TAD  ITEM
0312      1625 0100      AND  P77
0313      1626 7106      CLL  RTL
0314      1627 7006      RTL
0315      1630 7006      RTL
0316      1631 3033      DCA  EVAL
0317      1632 4241      JMS  STGET
0320      1633 5267      JMP  STDUMP
0321      1634 1051      TAD  ITEM
0322      1635 0100      AND  P77
0323      1636 1033      TAD  EVAL
0324      1637 3033      DCA  EVAL
0325      1640 5216      JMP  STLOOP
0326      /
0327      1641 0000  STGET, 0
0330      1642 4703      JMS I  GENINI
0331      1643 1024      TAD  VAL
0332      1644 7640      SZA  CLA
0333      1645 2241      ISZ  STGET
0334      1646 1122      TAD  M43
0335      1647 1051      TAD  ITEM
0336      1650 7640      SZA  CLA
0337      1651 5261      JMP  STNOT
0340      1652 4465      JMS I  PASSEK
0341      1653 4466      JMS I  CURSKA
0342      1654 4532      JMS I  SCLEAR
0343      1655 1705      TAD I  SPT060
0344      1656 3173      DCA  SPCUNT
0345      1657 4530      JMS I  LINENO
0346      1660 5641      JMP I  STGET
0347      1661 1051  STNOT, TAD  ITEM
0350      ASMIFZ  TERMC-44
0351      TAD  STM44
0352      1662 7640      SZA  CLA
0353      1663 5641      JMP I  STGET
0354      1664 4702      JMS I  SQERR
0355      1665 4702      JMS I  SQERR
0356      1666 5517      JMP I  MON
0357      /

```

*DO inclusive OR*

*/Text pseudo-op*

*/GET THE CHAR,  
/DO WE WANT A DOLLAR SIGN AT THE END,  
/YEP, ADD IT IN,*

```

0360      1667 1033  STODUMP, TAD      EVAL
0361      1670 4704          JMS I  ONEREI
0362      1671 4465          JMS I  PASSEK
0363      1672 4500          JMS I  TYCARI
0364      1673 1051  STNODUMP, TAD    ITEM
0365      1674 1122          TAD      M43
0366      1675 7650          SNA CLA
0367      1676 5701          JMP I  SQFDRT
0370      1677 4703          JMS I  GENINI
0371      1700 5274          JMP      STNODUMP+1
0372      /
0373      /
0374      /
0375      /
0376      /
0377      1701 2714  STM44, -44
0400      1702 3201  SQFDRT, FDRT
0401      1703 3670  SQERR, ERROR
0402      1704 1436  ONEREI, ONEREG
0403      1705 1576  SPT060, M60
0404      /
0405      1706 0000  JBTEST, 0
0406      1707 2012  JBMSTR, ISZ     CURLIN
0407      1710 7300          CLA CLL
0410      1711 7240          CLA CMA
0411      1712 3003          DCA   LISTWD
0412      1713 1332          TAD   JBSMF
0413      1714 3307          DCA   JBMSTR
0414      1715 1012          TAD   CURLIN
0415      1716 7421          TAD   7421
0416      1717 7501          TAD   7501
0417      1720 7161          CLL CML CMA IAC
0420      1721 1333          TAD   JSTART
0421      1722 7660          SNL SZA CLA
0422      1723 5706          JMP I  JBTEST
0423      1724 1334          TAD   JEND
0424      1725 7161          CLL CML CMA IAC
0425      1726 1012          TAD   CURLIN
0426      1727 7670          SZL SNA CLA
0427      1730 3003  JNOP,   DCA   LISTWD
0430      1731 5706          JMP I  JBTEST
0431      /
0432      /
0433      1732 2012  JBSMF, ISZ     CURLIN
0434      1733 0000  JSTART, 0
0435      1734 7777  JEND,   7777
0436      1735 7777  M1A,   -1
0437      /
0440      /
0441      /
0442      /
0443      /
0444      /
0445      /
0446      /
0447      1736 0000  SAVE,   0
0450      1737 1026          TAD SCURR
0451      1740 3347          DCA RESTOR-2
0452      1741 1014          TAD TYPEA
0453      1742 3346          DCA RESTOR-3
0454      1743 1021          TAD TYPE
0455      1744 3350          DCA RESTOR-1
0456      1745 5736          JMP I  SAVE

```

```

/DO WE WANT THE LITTERAL IN???
/YEP. ASSEMBLE IT IN,

```

```

/THIS IS MADE A NOP FOR THE SEMI-COLON FUDGE

```

```

/RESET THE FUDGE SWITCH
/BY REPLACING THE ISZ

```

```

/THIS CODE DISPLAYS THE LINE NUMBER BEING
/ASSEMBLED IN THE MQ.

```

*if so we can look back 1 symbol*

0457	1746	0000	0
0460	1747	0000	0
0461	1750	0000	0
0462	1751	0000	RESTOR, 0
0463	1752	1347	TAD RESTOR-2
0464	1753	4512	JMS I SDECO1
0465	1754	1346	TAD RESTOR-3
0466	1755	3014	DCA TYPE A
0467	1756	1350	TAD RESTOR-1
0470	1757	3021	DCA TYPE
0471	1760	5751	JMP I RESTOR
0472		/	
0473		/	
0474		/	
0475		/	
0476			EJECT

*restore pointers saved by same*

TMS ENTS  
TYPE  
return

*enter a symbol in table*

```
0477 /PDP-12 ASSEMBLER PAGE 8
0500 *2000
0501 2000 0000 ENTS, 0
0502 2001 1027 TAD SEND
0503 2002 4512 JMS I SDECO1
0504 2003 6211 6211
0505 2004 1024 TAD VAL
0506 2005 3422 DCA I VADR
0507 2006 1161 TAD TEM1
0510 2007 3423 DCA I SADR
0511 2010 2023 ISZ SADR
0512 2011 1162 TAD TEM2
0513 2012 3423 DCA I SADR
0514 2013 2023 ISZ SADR
0515 2014 1163 TAD TEM3
0516 2015 3423 DCA I SADR
0517 2016 6201 6201
0520 2017 7344 HTHO
0521 2020 1023 TAD SADR
0522 2021 7450 SNA
0523 2022 5635 JMP I SADROV
0524 2023 3023 DCA SADR
0525 2024 1600 TAD I ENTS
0526 2025 3227 DCA ,+2
0527 2026 4511 JMS I TYPAD1
0530 2027 0000 0
0531 2030 2200 ISZ ENTS
0532 2031 2027 ISZ SEND
0533 2032 5600 JMP I ENTS
0534 /
0535 2033 1175 SADROV, STEXD
0536 2034 7721 M57, -57
0537 2035 3670 GETS, GETIN
0540 2036 3701 COMS, COMMEN
0541 /
0542 2037 0000 IDX, 0
0543 2040 4635 JMP I GETS
0544 2041 1234 TAD M57
0545 2042 7650 SNA CLA
0546 2043 5636 JMP I COMS
0547 2044 1051 TAD ITEM
0550 ASMI FZ TERM C-44
0551 TAD M44
0552 2045 7650 SNA CLA
0553 2046 5773 JMP I FINEND
0554 2047 4464 BIT, JMS I BIT6A
0555 2050 3044 DCA CHARX
0556 2051 1044 TAD CHARX
0557 2052 3045 DCA CHARX2
0560 2053 5637 JMP I IDX
0561 2054 0000 EMPTY, 0
0562 2055 1003 TAD LISTWD
0563 2056 7040 CMA
0564 2057 0035 AND PASS
0565 2060 7650 SNA CLA
0566 2061 5654 JMP I EMPTY
0567 2062 1057 TAD CHARAC
0570 2063 7450 SNA
0571 2064 5330 JMP EMLEVE
0572 2065 7041 CIA
0573 2066 3057 DCA CHARAC
0574 2067 3175 DCA TBCONT
0575 2070 1174 TAD SY
```

*pointer to 1st free loc.*

/RESET TO FIELD 0.  
/BACK UP SADR TO FIRST WORD OF NAME  
/IS IT ZERO?  
/YES, TO MANY SYMBOLS, ABORT WITH ERROR  
/OK, RESTORE SADR NOW.  
*get type*

/POINTER TO TOO MANY SYMBOLS ERROR,

/IS END OF FILE CHAR A 44??  
/YEP, ASSEMBLE IT IN NOW,

/GET THE LISTING WORD  
/NEGATE IT,  
/AND WITH THE PASS,  
/LISTING AND PASS2?  
/NOPE, DONT PRINT ANYTHING

0576	2071	3172	DCA EMPTRA	
0577	2072	7410	SKP	
0600	2073	2172	TWOCHR, ISZ EMPTRA	
0601	2074	1572	TAD I EMPTRA	
0602	2075	7012	RTR	
0603	2076	7012	RTR	
0604	2077	7012	RTR	
0605	2100	0160	AND P77	
0606	2101	3007	DCA TEMP	
0607	2102	7040	CMA	
0610	2103	3170	DCA SWITCH	
0611	2104	1007	TAD TEMP	
0612	2105	1133	TAD M47	
0613	2106	7650	SNA CLA	
0614	2107	5356	NOTAB1, JMP OUTTAB	
0615	2110	4347	JMS OUTTP	
0616	2111	2057	DRHT, ISZ CHARAC	
0617	2112	5314	JMP ,+2	
0620	2113	5330	JMP EMLEVE	
0621	2114	4746	JMS I LNCKA	
0622	2115	1572	TAD I EMPTRA	
0623	2116	0160	AND P77	
0624	2117	3007	DCA TEMP	
0625	2120	3170	DCA SWITCH	
0626	2121	1007	TAD TEMP	
0627	2122	1133	TAD M47	
0630	2123	7650	SNA CLA	
0631	2124	5356	NOTAB2, JMP OUTTAB	/REPLACED BY A TAD M7
0632	2125	4347	JMS OUTTP	
0633	2126	2057	DLFT, ISZ CHARAC	
0634	2127	5344	JMP TWOCH	
0635	2130	4500	EMLEVE, JMS I TYCARI	
0636	2131	5654	JMP I EMPTY	
0637	2132	0000	CLEARR, 0	
0640	2133	3057	DCA CHARAC	
0641	2134	3772	DCA I SWOTA	
0642	2135	1167	TAD ERRCNT	
0643	2136	1002	TAD ERTOT	
0644	2137	3002	DCA ERTOT	
0645	2140	3167	DCA ERRCNT	
0646	2141	1174	TAD SY	
0647	2142	3514	DCA I SYB	
0650	2143	5732	JMP I CLEARR	
0651	2144	4746	TWOCH, JMS I LNCKA	
0652	2145	5273	JMP TWOCHR	
0653	2146	3737	LNCKA, LNCK	
0654	2147	0000	OUTTP, 0	
0655	2150	1007	TAD TEMP	
0656	2151	4755	JMS I ONVRT	
0657	2152	4401	JMS I DECONT	
0660	2153	2175	ISZ TBCONT	
0661	2154	5747	JMP I OUTTP	
0662	2155	3600	ONVRT, CONVRT	
0663	2156	1175	OUTTAB, TAD TBCONT	
0664	2157	1371	TAD M10	
0665	2160	7500	SMA	
0666	2161	5357	JMP , -2	
0667	2162	4770	JMS I KLUG2	
0670	2163	4475	JMS I SKIP	
0671	2164	3175	DCA TBCONT	
0672	2165	2170	ISZ SWITCH	
0673	2166	5326	JMP DLFT	
0674	2167	5311	JMP DRHT	

0675	2170	3744	KLUG2,	SPACK
0676	2171	7770	M10,	-10
0677	2172	1556	SWOTA,	SWOT
0700	2173	3717	FINEND,	ENDMS
0701	2174	7771	M7TWO,	-7
0702				EJECT

-

*include precision integers?*

```
0703 /PDP-12 ASSEMBLER PAGE 9
0704 +2200
0705 2200 0000 OPCV, 0
0706 2201 2020 ISZ ANY
0707 2202 3052 DCA HIC /CLEAR HIGH AND LOW PARTS
0710 2203 3053 DCA LWC
0711 2204 1045 TAD CHARX2 / GET THE NEXT CHARACTER
0712 2205 1126 TAD M67
0713 2206 7450 SNA
0714 2207 5212 JMP DPCS
0715 2210 1242 TAD DPCVM2
0716 2211 7650 SNA CLA
0717 2212 4504 DPCS, JMS I IDX1 /INDEX CHARACTER POINTER
0720 2213 1045 TAD CHARX2
0721 2214 1125 TAD M45
0722 2215 7500 SMA
0723 2216 5600 JMP I DPCV
0724 2217 1241 TAD P12 /IF LESS OR EQUAL TO 9 CHECK FOR GR
0725 2220 7510 SPA /EQ, ZERO
0726 2221 5600 JMP I DPCV /LESS THAN ZERO, EXIT NOT DIGIT
0727 2222 3273 OCA MTDG
0730 2223 4243 JMS MT10
0731 2224 5212 JMP DPCS
0732 2225 4231 DECIM, JMS DECIMS
0733 2226 5503 JMP I B21
0734 2227 4235 OCT, JMS OCTS
0735 2230 5503 JMP I B21
0736 2231 0000 DECIMS, 0
0737 2232 1255 TAD MTSW+4
0740 2233 3251 DCA MTSW
0741 2234 5631 JMP I DECIMS
0742 2235 0000 OCTS, 0
0743 2236 1121 TAD M1000
0744 2237 3251 DCA MTSW
0745 2240 5635 JMP I OCTS
0746 2241 0012 P12, 12
0747 2242 7776 OPCVM2, -2
0750 /MULTIPLY LWC BY 10,
0751 2243 0000 MT10, 0
0752 2244 1053 TAD LWC
0753 2245 0156 AND P777
0754 2246 3274 DCA TIC
0755 2247 4257 JMS MTRL
0756 2250 4257 JMS MTRL
0757 2251 4265 MTSW, JMS MTAD /NOP FOR OCTAL, JMS MTAD FOR DECIMAL
0760 2252 4257 JMS MTRL
0761 2253 1273 TAD MTDG
0762 2254 3274 DCA TIC
0763 2255 4265 JMS MTAD
0764 2256 5643 JMP I MT10
0765 /ROTATE LWC LEFT 1
0766 2257 0000 MTRL, 0
0767 2260 7300 CLL CLA
0770 2261 1053 TAD LWC
0771 2262 7004 RAL
0772 2263 3053 DCA LWC
0773 2264 5657 JMP I MTRL
0774 /ADD LWC TO TIC
0775 2265 0000 MTAD, 0
0776 2266 7300 CLL CLA
0777 2267 1053 TAD LWC
1000 2270 1274 TAD TIC
1001 2271 3053 DCA LWC
```



1002	2272	5665	JMP I MTAD
1003			/SOME DATA STORAGE
1004	2273	0000	MTDG, 0
1005	2274	0000	TIC, 0
1006	2275	0000	ERR2, 0
1007	2276	1021	TAD TYPE
1010	2277	1136	TAD P6000
1011	2300	7650	SNA CLA
1012	2301	5675	JMP I ERR2
1013	2302	1014	TAD TYPEA
1014	2303	7106	CLL RTL
1015	2304	0136	AND P6000
1016	2305	6211	6211
1017	2306	1422	TAD I VADR
1020	2307	6201	6201
1021	2310	7041	CIA
1022	2311	1030	TAD AADR
1023	2312	7650	SNA CLA
1024	2313	5675	JMP I ERR2
1025	2314	7326	CLA CLL CML RTL
1026	2315	4476	JMS I ERR1
1027	2316	5675	JMP I ERR2
1030	2317	0000	UNDERR, 0
1031	2320	2035	ISZ PASS
1032	2321	5332	JMP EQCHK
1033	2322	3007	DCA TEMP
1034	2323	7040	CMA
1035	2324	3035	DCA PASS
1036	2325	1007	TAD TEMP
1037	2326	4476	JMS I ERR1
1040	2327	7240	CLA CMA
1041	2330	3035	DCA PASS
1042	2331	5717	JMP I UNDERR
1043	2332	1135	EQCHK, TAD M4
1044	2333	7650	SNA CLA
1045	2334	4740	JMS I EQCHKI
1046	2335	7240	CLA CMA
1047	2336	3006	DCA EQRET1
1050	2337	5330	JMP EQCHK-2
1051	2340	3366	EQCHKI, EQUCHK
1052	2341	0000	PUSH2, 0
1053	2342	3275	DCA ERR2
1054	2343	1142	TAD P5000
1055	2344	1047	TAD POINT
1056	2345	7700	SMA CLA
1057	2346	5364	JMP ERR12
1060	2347	1275	TAD ERR2
1061	2350	3447	DCA I POINT
1062	2351	2047	ISZ POINT
1063	2352	5741	JMP I PUSH2
1064	2353	0000	CNTRLP, 0
1065	2354	0031	KSF
1066	2355	5753	JMP I CNTRLP
1067	2356	0036	KRB
1070	2357	1151	TAD M215
1071	2360	7650	SNA CLA
1072	2361	5763	JMP I CNTHON
1073	2362	5753	JMP I CNTRLP
1074			/
1075	2363	4075	CNTHON, KILBUF
1076			/
1077	2364	1015	ERR12, TAD P11
1100	2365	4476	JMS I ERR1

*is symbol defined?*

*NO yes - does old def = new def?*

*get old val.*

*get new val.*

*1-2 ID error*

*is it pushdown overflow*

*check for car. ret to terminate assembly*

*/RETURN TO KILL BUFFER MONITOR RESTART*

*00 = spec. char.  
01 = undefined  
10 = defined  
11 = pseudo-CP*

1101	2366	5517		JMP I MON
1102	2367	0000	ANYY,	0
1103	2370	1021		TAD TYPE
1104	2371	1136		TAD P6000
1105	2372	7450		SNA
1106	2373	2020		ISZ ANY
1107	2374	1136		TAD P6000
1110	2375	7650		SNA CLA
1111	2376	2020		ISZ ANY
1112	2377	5767		JMP I ANYY
1113				EJECT

*# Anything assembled on current line,  
"ANYY" is indexed*

-

*output symbols in alphabetical order*

```
1114 /PDP-12 ASSEMBLER PAGE 10
1115 +2400
1116 2400 0000 ALPHA, 0
1117 2401 4500 JMS I TYCARI
1120 2402 3307 SYMBLP, DCA FOUND
1121 2403 1032 TAD PERMA
1122 2404 3026 DCA SCURR
1123 2405 7350 CLA CMA CLL RAR
1124 2406 3040 DCA TEM1A
1125 2407 7350 CLA CLL CMA RAR
1126 2410 3041 DCA TEM1A+1
1127 2411 7350 CLA CMA CLL RAR
1130 2412 3042 DCA TEM1A+2
1131 2413 1026 NXCAND, TAD SCURR
1132 2414 7041 CIA
1133 2415 1027 TAD SEND
1134 2416 7650 SNA CLA
1135 2417 5274 JMP PRSYMB
1136 2420 1026 TAD SCURR
1137 2421 4512 JMS I SDECO1
1140 2422 6211 6211
1141 2423 1423 TAD I SADR
1142 2424 7104 CLL RAL
1143 2425 7020 CML
1144 2426 7530 SZL SPA
1145 2427 5270 JMP REJECT
1146 2430 7070 RAR CMA CML
1147 2431 1040 TAD TEM1A
1150 2432 7040 CMA
1151 2433 7640 SZA CLA
1152 2434 5252 JMP JUDGE
1153 2435 2023 ISZ SADR
1154 2436 7350 CLA CLL CMA RAR
1155 2437 0423 AND I SADR
1156 2440 7040 CMA
1157 2441 1041 TAD TEM1A+1
1160 2442 7040 CMA
1161 2443 7640 SZA CLA
1162 2444 5252 JMP JUDGE
1163 2445 2023 ISZ SADR
1164 2446 7350 CLA CLL CMA RAR
1165 2447 0423 AND I SADR
1166 2450 7160 CMA CLL CML
1167 2451 1042 TAD TEM1A+2
1170 2452 7630 JUDGE, SZL CLA
1171 2453 5270 JMP REJECT
1172 2454 6201 CDF 0
1173 2455 1026 TAD SCURR
1174 2456 4512 JMS I SDECO1
1175 2457 1023 TAD SADR
1176 2460 4474 JMS I MOVE1
1177 2461 0040 TEM1A
1200 2462 6211 6211
1201 2463 6211 6211
1202 2464 1416 TAD I 16
1203 2465 3024 DCA VAL
1204 2466 1023 TAD SADR
1205 2467 3307 DCA FOUND
1206 2470 7200 REJECT, CLA
1207 2471 6201 CDF 0
1210 2472 2026 ISZ SCURR
1211 2473 5213 JMP NXCAND
1212 /
```

```

1213 2474 1307 PRSYMB, TAD FOUND
1214 2475 7450 SNA
1215 2476 5600 JMP I ALPHA
1216 2477 3023 DCA SADR
1217 2500 7240 CLA CMA
1220 2501 6211 6211
1221 2502 3707 DCA I FOUND
1222 2503 6201 CDF 0
1223 2504 4706 JMS I POSANDV
1224 2505 5202 JMP SYMBLP
1225 /
1226 /
1227 /
1230 2506 2600 POSANDV, OS ANDV
1231 2507 0000 FOUND, 0
1232 /
1233 /
1234 /
1235 /
1236 2510 0000 TYCAR, 0
1237 2511 1154 TAD P215
1240 2512 4401 JMS I DECOU
1241 2513 1153 TAD P212
1242 2514 4401 JMS I DECOU
1243 2515 4470 JMS I CHEKER
1244 2516 4404 JMS I CNTLPI
1245 2517 5710 JMP I TYCAR
1246 2520 0000 CURSKP, 0
1247 2521 1012 TAD CURLIN
1250 2522 4462 JMS I SOPS
1251 2523 1335 TAD M22
1252 2524 4475 JMS I SKIP
1253 2525 4461 JMS I EMPTY1
1254 2526 5720 JMP I CURSKP
1255 2527 0000 TYPO, 0
1256 2530 6041 TSF
1257 2531 5330 JMP , -1
1260 2532 6046 TLS
1261 2533 7200 CLA
1262 2534 5727 JMP I TYPO
1263 2535 7756 M22, -22
1264 TEMP A=TYCAR
1265 /
1266 /
1267 /
1270 /
1271 /
1272 /
1273 /
1274 2536 4747 XCHAIN, JMS I OXWRIT
1275 2537 2555 XPSEU
1276 2540 4746 JMS I OXREAD
1277 2541 2551 XINIT
1300 2542 4750 JMS I XPP
1301 2543 4746 JMS I OXREAD
1302 2544 2555 XPSEU
1303 2545 5501 JMP I MAIN1
1304 /
1305 /
1306 /
1307 /
1310 2546 7774 OXREAD, 7774
1311 2547 7775 OXWRIT, 7775

```

/TEST FOR CARRAGE RETURN

```

1312 2550 5000 XPP, XXXX
1313 2551 0100 XINIT, DIALUNIT
1314 2552 0012 12
1315 2553 0024 BCHAIN
1316 2554 0001 1
1317 /
1320 /
1321 2555 0100 XPSEU, DIALUNIT
1322 2556 0012 12
1323 2557 0025 SCRATCH
1324 2560 0001 1
1325 /
1326 /
1327 /
1330 /
1331 /
1332 /
1333 /
1334 /
1335 /
1336 /
1337 /
1340 2561 0000 SEMITX, 0
1341 2562 1375 TAD XM13
1342 2563 7450 SNA
1343 2564 5367 JMP ,+3
1344 2565 1376 TAD XP46
1345 2566 5761 JMP I SEMITX
1346 2567 1373 TAD SEMFDG
1347 2570 3774 OCA I SEMPTF
1350 2571 1376 TAD XP46
1351 2572 5761 JMP I SEMITX
1352 /
1353 /
1354 /
1355 2573 7000 SEMFDG, NOP
1356 2574 1707 SEMPTF, JBMSTR
1357 2575 7765 XM13, -13
1360 2576 0046 XP46, 46
1361 /
1362 /
1363 /
1364 /
1365 /
1366 /
1367 EJECT

```

/REPLACE LINE BOPPER BY A NOP

/POINTER TO THE ISZ,

```

1370 /PDP-12 ASSEMBLER PAGE 11
1371 /OUTPUT A SYMBOL AND ITS VALUE
1372 *2600
1373 OSANDV, 0
1374 2601 4213 JMS OSYM /OUTPUT SYMBOL
1375 2602 1175 TAD TBCONT
1376 2603 1302 TAD M7
1377 2604 4475 JMS I SKIP /OUTPUT TAB
1400 2605 4624 JMS I LINK8
1401 2606 1024 TAD VAL
1402 2607 4261 JMS OPS /OUTPUT NUMBER
1403 2610 4500 JMS I TYCARI
1404 2611 4404 JMS I CNTLPI
1405 2612 5600 JMP I OSANDV
1406 2613 0000 OSYM, 0
1407 2614 3175 DCA TBCONT
1410 2615 1040 TAD TEM1A
1411 2616 4225 JMS OX
1412 2617 1041 TAD TEM1A+1
1413 2620 4225 JMS OX
1414 2621 1042 TAD TEM1A+2
1415 2622 4225 JMS OX
1416 2623 5613 JMP I OSYM
1417 2624 3551 LINK8, LINK8A
1420 2625 0000 OX, 0
1421 2626 3053 DCA LWC
1422 2627 3052 DCA HIC
1423 2630 1053 TAD LWC
1424 2631 7450 SNA
1425 2632 5613 JMP I OSYM
1426 2633 1125 TAD M45
1427 2634 7510 SPA
1430 2635 5240 JMP DV3
1431 2636 2052 ISZ HIC
1432 2637 5233 JMP ,-4
1433 2640 1301 DV3, TAD P45
1434 2641 3053 DCA LWC
1435 2642 1052 TAD HIC
1436 2643 4247 JMS UNTRAN
1437 2644 1053 TAD LWC
1440 2645 4247 JMS UNTRAN
1441 2646 5625 JMP I OX
1442 2647 0000 UNTRAN, 0
1443 2650 7450 SNA
1444 2651 5613 JMP I OSYM
1445 2652 1123 TAD M33
1446 2653 7510 SPA
1447 2654 1303 TAD P53
1450 2655 1304 TAD P260
1451 2656 4401 JMS I DECOU
1452 2657 2175 ISZ TBCONT
1453 2660 5647 JMP I UNTRAN
1454 /OCTAL PRINT SUBROUTINE
1455 2661 0000 OPS, 0
1456 2662 3213 DCA OSYM
1457 2663 1135 TAD M4
1460 2664 3175 DCA TBCONT
1461 2665 1213 TAD OSYM
1462 2666 7006 RTL
1463 2667 7004 RAL
1464 2670 3213 DCA OSYM
1465 2671 1213 TAD OSYM
1466 2672 7004 RAL

```

*Derode a word of symbol by =45y*

*convert from 6 bit internal to ASCII*

1467	2673	0157	AND P7
1470	2674	1304	TAD P260
1471	2675	4401	JMS I DECOU
1472	2676	2175	ISZ TBCONT
1473	2677	5265	JMP OPS+4
1474	2700	5661	JMP I OPS
1475	2701	0045	P45, 45
1476	2702	7771	M7, -7
1477	2703	0053	P53, 53
1500	2704	0260	P260, 260
1501	2705	4477	FLDUP, JMS I EXPR1
1502	2706	1037	TAD MODE
1503	2707	7700	SMA CLA
1504	2710	5314	JMP FDRT
1505	2711	1020	TAD ANY
1506	2712	7640	SZA CLA
1507	2713	5317	JMP FIELDM
1510	2714	4465	FDRT, JMS I PASSEK
1511	2715	4466	JMS I CURSKA
1512	2716	5501	JMP I MAIN1
1513	2717	1033	FIELDM, TAD EVAL
1514	2720	7710	SPA CLA
1515	2721	5314	JMP FDRT
1516	2722	7344	MTWO
1517	2723	1033	TAD EVAL
1520	2724	7700	SMA CLA
1521	2725	5314	JMP FDRT
1522	2726	1033	TAD EVAL
1523	2727	3036	DCA FLDWD
1524	2730	5314	JMP FDRT
1525			LISTA=,
1526			EJECT

```

1527      /PDP-12 ASSEMBLER PAGE 12
1530      *3000
1531      3000 2661      OPS
1532      3001 0000      PUNONE, 0
1533      3002 5601      JMP I PUNONE      /NOP FOR PASS 2
1534      3003 1030      TAD AADR
1535      3004 0155      AND P7400
1536      3005 7106      CLL RTL
1537      3006 7006      RTL
1540      3007 7004      RAL
1541      3010 1176      TAD BINTAB
1542      3011 3010      DCA BINPTR
1543      3012 1036      TAD FLOWD
1544      3013 7650      SNA CLA
1545      3014 5220      JMP BINCK
1546      3015 1010      TAD BINPTR
1547      3016 1300      TAD P20
1550      3017 3010      DCA BINPTR
1551      3020 1010      BINCK, TAD BINPTR
1552      3021 7041      CIA
1553      3022 1011      TAD BINBLK
1554      3023 7640      SZA CLA
1555      3024 4676      JMS I NOTBL1
1556      3025 4577      JMS I SETINU      /SET BITS NOWWIN HEADER BLOCK
1557      3026 1030      TAD AADR
1560      3027 0277      AND P377
1561      3030 1142      TAD P5000
1562      3031 3140      DCA LOWTMP
1563      3032 1033      TAD EVAL
1564      3033 3540      DCA I LOWTMP
1565      3034 1003      TAD LISTWD
1566      3035 7710      SPA CLA
1567      3036 5601      JMP I PUNONE
1570      3037 1167      TAD ERRCNT
1571      3040 7640      SZA CLA
1572      3041 5246      JMP NONER
1573      3042 1012      ABNOP1, TAD CURLIN
1574      3043 4600      ABNOP2, JMS I PUNONE-1
1575      3044 1301      ABNOP3, TAD M6
1576      3045 4475      ABNOP4, JMS I SKIP
1577      3046 1037      NONER, TAD MODE
1600      3047 7700      SMA CLA
1601      3050 5262      JMP LNKA
1602      3051 1030      TAD AADR
1603      3052 4600      AADRL, JMS I PUNONE-1
1604      3053 7344      MTWO
1605      3054 4475      JMS I SKIP
1606      3055 1033      TAD EVAL
1607      3056 4600      JMS I PUNONE-1
1610      3057 7344      MTWO
1611      3060 4475      JMS I SKIP
1612      3061 5601      JMP I PUNONE
1613      3062 1030      LNKA, TAD AADR
1614      3063 0136      AND P6000
1615      3064 7041      CIA
1616      3065 1046      TAD ABANK
1617      3066 7650      SNA CLA
1620      3067 5273      JMP SAMES
1621      3070 1030      TAD AADR
1622      3071 0131      AND P3777
1623      3072 5252      JMP AADRL
1624      3073 1030      SAMES, TAD AADR
1625      3074 0144      AND P1777

```

*outputs contents of EVAL  
(the generated binary)*



```
1626      3075 5252          JMP AADR1
1627      3076 3616 NOTBL1, NOTBLK
1630      3077 0377 P377, 377
1631      3100 0020 P20, 20
1632      3101 7772 H0, -6
1633          SYMBUF=,
1634          /
1635          /
1636          /
1637          /
1640          /
1641          /
1642          /
1643          /
1644          /
1645          /
1646          /
1647          EJECT
```

```

1650 /PDP-12 ASSEMBLER PAGE 13
1651 *3200
1652 /
1653 /
1654 3200 3271 / TABLE
1655 /
1656 3201 0000 ERROR, 0
1657 3202 1200 TAD ,-2
1660 3203 3237 DCA UNREF-1
1661 3204 4465 JMS I PASSEK
1662 3205 1167 TAD ERRCNT
1663 3206 7640 SZA CLA
1664 3207 4500 JMS I TYCARI
1665 3210 1012 TAD CURLIN
1666 3211 4462 JMS I SOPS
1667 3212 7344 MTHO
1670 3213 4475 JMS I SKIP
1671 3214 1637 TAD I UNREF-1
1672 3215 0160 AND P77
1673 3216 1143 TAD P300
1674 3217 4401 JMS I DECOUT
1675 3220 1637 TAD I UNREF-1
1676 3221 7012 RTR
1677 3222 7012 RTR
1700 3223 7012 RTR
1701 3224 0160 AND P77
1702 3225 1143 TAD P300
1703 3226 4401 JMS I DECOUT
1704 3227 7344 MTHO
1705 3230 4475 JMS I SKIP
1706 3231 2167 ISZ ERRCNT
1707 3232 7000 NOP
1710 3233 4465 JMS I PASSEK
1711 3234 7410 SKP
1712 3235 4500 JMS I TYCARI
1713 3236 5001 JMP I ERROR
1714 /
1715 3237 0000 0
1716 3240 2317 UNREF, UNDERR
1717 3241 1332 AAS
1720 3242 0000 GETASY, 0
1721 3243 7200 CLA
1722 3244 3050 DCA IN
1723 3245 4641 JMS I GETASY-1
1724 3246 1050 TAD IN
1725 3247 7650 SNA CLA
1726 3250 5642 JMP I GETASY
1727 3251 4670 JMS I SEAR1
1730 3252 7610 SKP CLA
1731 3253 5262 JHP CKUN
1732 3254 3024 DCA VAL
1733 3255 4667 JMS I ENTS1
1734 3256 2000 USYMB
1735 3257 7307 CLA CLL IAC RTL /4
1736 3260 4640 JMS I GETASY-2
1737 3261 5642 JMP I GETASY
1740 3262 1021 CKUN, TAD TYPE
1741 3263 1136 TAD P6000
1742 3264 7640 SZA CLA
1743 3265 5642 JMP I GETASY
1744 3266 5257 JMP CKUN-3
1745 3267 2000 ENTS1, ENTS
1746 3270 0266 SEAR1, SEARCH

```

/CHECK FOR LISTING AND PASS2.

*not a transfer from input  
 10/12/68 TRW - RW*

/FOUND

/US

*un def mod*

```

1747
1750
1751
1752
1753
1754
1755
1756
1757
1760
1761
1762
1763
1764
1765
1766
1767
1770
1771
1772
1773
1774
1775
1776
1777
2000
2001
2002
2003
2004
2005
2006
2007
2010
2011
2012
2013
2014
2015
2016
2017
2020
2021
2022
2023
2024
2025
2026
2027
2030
2031
2032
2033
2034
2035
2036
2037
2040
2041
2042
2043
2044
2045

```

3271	0511	/TABLE OF ERROR MESSAGES
3272	2211	TABLE, 0511 /IE ILLEGAL EQUALS
3273	0411	2211 /IR ILLEGAL REFERENCE
3274	0311	0411 /ID ILLEGAL REDEFINITION
3275	2325	0311 /IC ILLEGAL CHARACTER
3276	1503	2325 /US REFERENCE TO UNDEFINED SYMBOL
3277	1003	1503 /CM COMMA USED INCORRECTLY
3300	0523	1003 /CH CHAINING ERROR,
3301	0127	0523 /SE SYSBOL TABLE EXCEEDED
3302	2320	0127 /WA WORKING AREA EXCEEDED
3303	7610	2320 /PS PUSH DOWN LIST EXCEEDED
3304	7240	LNKMOD, CLA SKP
3305	3037	PDP0MD, CLA CMA
3306	1037	DCA MODE
3307	1316	TAD MODE
3310	3375	TAD P6321
3311	4772	DCA INSYM
3312	3373	JMS I SYREAD
3313	4463	SYCRAP
3314	4502	JMS I RESET1
3315	5503	JMS I PAGE1
3316	0042	JMP I B21
3317	0000	P6321, D6*42=300
3320	7300	SYSD, 0
3321	2351	CLA CLL
3322	5340	ISZ WDHALF
3323	1752	JMP LEFTHF
3324	0160	TAD I PTBUFF
3325	3007	AND P77
3326	2352	DCA TEMP
3327	2354	ISZ PTBUFF
3330	5336	ISZ CHRC
3331	1155	JMP RTHFT
3332	3354	TAD P7400
3333	1353	DCA CHRC
3334	3352	TAD PTBUFF
3335	4750	DCA PTBUFF
3336	1007	JMS I BUFI
3337	5717	RTHFT, TAD TEMP
3340	7040	JMP I SYSIN
3341	3351	LEFTHF, CMA
3342	1752	DCA WDHALF
3343	7012	TAD I PTBUFF
3344	7012	RTR
3345	7012	RTR
3346	0160	RTR
3347	5717	AND P77
3350	4006	JMP I SYSIN
3351	0000	BUFI, BUFIN
3352	0000	WDHALF, 0
3353	4400	PTBUFF, 0
3354	0000	PTBUFF, 4400
3355	0000	CHRC, 0
3356	1003	PASSER, 0
3357	7710	TAD LISTWD
3360	5364	SPA CLA
3361	1035	JMP ,+4
3362	7710	TAD PASS
3363	5755	SPA CLA
3364	2355	JMP I PASSER
3365	5755	ISZ PASSER
3366	0000	JMP I PASSER
		EQUCHK,0

/SWAP THE CORRECT SYMBOL TABLE IN NOW

/CLEAN UP THE SYSTEM, WE RE DONE WITH THIS ONE.

```
2046 3367 2006 ISZ EQRET1
2047 3370 4476 JMS I ERR1
2050 3371 5766 JMP I EQUCHK
2051 3372 7774 SYREAD, READ
2052 /
2053 /
2054 /
2055 /
2056 /
2057 /
2060 3373 0100 SYCRAP, DIALUNIT
2061 3374 0036 36
2062 3375 0000 INSYM, 0
2063 3376 0001 1
2064 /
2065 /
2066 /
2067 /
2070 /
2071 /
2072 /
2073 /
2074 /
2075 EJECT
```

```

2076 /PDP-12 ASSEMBLER PAGE 14
2077 /
2100 /
2101
2102 3400 0000 BIT6, *3400
2103 3401 1051 TAD ITEM
2104 3402 1013 TAD M40
2105 3403 7510 SPA
2106 3404 5225 JMP P1T037
2107 3405 1254 TAD M20
2110 3406 7510 SPA
2111 3407 5212 JMP P40T57
2112 3410 4640 JMS I SEMITZ
2113 3411 5600 JMP I BIT6
2114 3412 1015 P40T57, TAD P11
2115 3413 7450 SNA
2116 3414 5241 JMP TABA
2117 3415 1256 TAD P2
2120 3416 7450 SNA
2121 3417 5250 JMP P367A
2122 3420 1256 TAD P2
2123 3421 7450 SNA
2124 3422 5243 JMP CARET
2125 3423 1257 TAD P57
2126 3424 5600 JMP I BIT6
2127 3425 7200 P1T037, CLA
2130 3426 1051 TAD ITEM
2131 3427 1123 TAD M33
2132 3430 7510 SPA
2133 3431 5245 JMP ALPHAB
2134 3432 1262 TAD BIT6M3
2135 3433 7700 SNA CLA
2136 3434 5250 JMP P367A
2137 3435 1051 TAD ITEM
2140 3436 1260 TAD P41
2141 3437 5600 JMP I BIT6
2142 /
2143 /
2144 3440 2561 SEMITZ, SEMITX
2145 /
2146 /
2147 3441 1255 TABA, TAD P54
2150 3442 5600 JMP I BIT6
2151 3443 1261 CARET, TAD P46
2152 3444 5600 JMP I BIT6
2153 3445 7200 ALPHAB, CLA
2154 3446 1051 TAD ITEM
2155 3447 5600 JMP I BIT6
2156 3450 7325 P367A, PTHREE
2157 3451 4476 JMS I ERR1
2160 3452 5653 JMP I ,+1
2161 3453 2040 IDX+1
2162 3454 7760 M20, -20
2163 3455 0054 P54, 54
2164 3456 0002 P2, 2
2165 3457 0057 P57, 57
2166 3460 0041 P41, 41
2167 3461 0046 P46, 46
2170 3462 7775 BIT6M3, -3
2171 3463 0000 DISRET, 0
2172 3464 4500 JMS I TYCARI
2173 3465 1002 TAD ERTOT
2174 3466 7450 SNA

```

*converts ASCII to 6-bit internal*

*143 = P 47 = TMB? (DIM)*  
*1 Revert?*  
*143 - car net?*

/GIVE A CARRIAGE RETURN BEFORE THE SYMBOL TABLE  
 /GET THE TOTAL NUMBER OF ERRORS  
 /ZERO?

2175	3467	5277	JMP	LWD	/YEP, PRINT OUT MESSAGE WITH "NO" PREFIX
2176	3470	7110	CLL	RAR	/JUST 1 ERROR?
2177	3471	7450	SNA		
2200	3472	3320	DCA	MESSS	/REMOVE THE FINAL S NOW
2201	3473	7004	RAL		
2202	3474	4462	JMS I	SOPS	/OUTPUT THE OCTAL NUMBER OF ERRORS
2203	3475	2277	ISZ	LWD	/PUSH PAST THE "NO" PART OF THE MESSAGE
2204	3476	2277	ISZ	LWD	
2205					
2206	3477	1310	LWD,	TAD	MESS
2207	3500	7450		SNA	/ZERO??
2210	3501	5304	JMP	LWDE	/YEP, THATS ALL
2211	3502	4401	JMS I	DECOUT	/OUTPUT THE LETTER
2212	3503	5276	JMP	LWD-1	/GET THE NEXT CHARACTER NOW
2213					
2214	3504	1322	LWDE,	TAD	PCONT
2215	3505	3322		OCA	PCONT
2216	3506	5663	JMP I	DISRET	/AND RETURN TO CALLER
2217					/SYSTEM WILL GIVE THE EXTRA CRLF AFTER
2220					/DECIDING IF THERES ANY BINARY,
2221					
2222					
2223					
2224	3507	7677	LWDEFD,	7677	/MAGIC NUMBER FOR FORM FEED PROBLEM AT SYMBOL TABLE TIME.
2225					
2226					
2227					
2230					
2231					
2232	3510	0316	MESS,	316	/"NO"
2233	3511	0317		317	
2234	3512	0240		240	/" ERRORS"
2235	3513	0305		305	
2236	3514	0322		322	
2237	3515	0322		322	
2240	3516	0317		317	
2241	3517	0322		322	
2242	3520	0323	MESSS,	323	/FINAL OPTIONAL S
2243	3521	0000		0000	/TERMINATING ZERO WORD
2244					
2245					
2246					
2247					
2250					
2251	3522	7777	PCONT,	7777	
2252	3523	0043	P43,	43	
2253	3524	0000	PAGSET,	0	
2254	3525	2322	ISZ	PCONT	
2255	3526	5341	JMP	COSA	
2256	3527	1135	TAD	M4	
2257	3530	3016	DCA	16	
2260	3531	1323	TAD	P43	
2261	3532	1153	TATA,	TAD	P212
2262	3533	4401	JMS I	DECOUT	
2263	3534	1154	TAD	P215	
2264	3535	4401	JMS I	DECOUT	
2265	3536	2016	ISZ	16	
2266	3537	5332	JMP	TATA	
2267	3540	5724	JMP I	PAGSET	
2270	3541	1322	COSA,	TAD	PCONT
2271	3542	7041		CIA	
2272	3543	1127	TAD	P76	
2273	3544	7640	SZA	CLA	

2274	3545	5724	JMP I PAGSET
2275	3546	7240	CLA CMA
2276	3547	3322	DCA PCONT
2277	3550	5724	JMP I PAGSET
2300	3551	0000	LINK8A, 0
2301	3552	6211	6211
2302	3553	4767	JMS I GYP
2303	3554	6201	6201
2304	3555	1014	TAD TYPEA
2305	3556	0144	AND P1777
2306	3557	7650	SNA CLA
2307	3560	5751	JMP I LINK8A
2310	3561	1014	TAD TYPEA
2311	3562	7106	RTL CLL
2312	3563	0136	AND P6000
2313	3564	1024	TAD VAL
2314	3565	3024	DCA VAL
2315	3566	5751	JMP I LINK8A
2316	3567	3623	GYP, GETYPE
2317	3570	7300	THOU, CLA CLL
2320	3571	1053	TAD LWC
2321	3572	7012	RTR
2322	3573	7012	RTR
2323	3574	3164	DCA CON
2324	3575	5776	JMP I C1A
2325	3576	1055	C1A, C
2326			/
2327			/
2330			/
2331			/
2332			EJECT

*1) line mode, add on the two wind bits  
for printout*

```

2333          /PDP-12 ASSEMBLER PAGE 15
2334          /
2335          /
2336          *3600
2337          /
2340      3600 0000  CONVRT, 0
2341      3601 0160          AND P77
2342      3602 1013          TAD M40
2343      3603 7510          SPA
2344      3604 1351          TAD P100
2345      3605 1134          TAD P240
2346      3606 5600          JMP I CONVRT
2347          /
2350          /
2351          /
2352          /
2353      3607 0000  UPLN, 0
2354      3610 4500          JMS I TYCARI
2355      3611 1261          TAD M26
2356      3612 4475          JMS I SKIP
2357      3613 1262          TAD M60A
2360      3614 3173          DCA SPCUNT
2361      3615 5607          JMP I UPLN
2362      3616 0000  NOTBLK, 0
2363      3617 1011          TAD BINBLK
2364      3620 4513          JMS I SRITIC
2365      3621 4253          JMS SETUSE
2366      3622 5616          JMP I NOTBLK
2367      3623 0000  GETYPE, 0
2370      3624 1423          TAD I SADR
2371      3625 0136          AND P6000
2372      3626 3014          DCA TYPEA
2373      3627 2023          ISZ SADR
2374      3630 1423          TAD I SADR
2375      3631 0150          AND P4000
2376      3632 7112          CLL RTR
2377      3633 1014          TAD TYPEA
2400      3634 3014          DCA TYPEA
2401      3635 2023          ISZ SADR
2402      3636 1423          TAD I SADR
2403      3637 7012          RTR
2404      3640 7010          RAR
2405      3641 0124          AND P400
2406      3642 1014          TAD TYPEA
2407      3643 3014          DCA TYPEA
2410      3644 1014          TAD TYPEA
2411      3645 0136          AND P6000
2412      3646 3021          DCA TYPE
2413      3647 7344          MTHO
2414      3650 1023          TAD SADR
2415      3651 3023          DCA SADR
2416      3652 5623          JMP I GETYPE
2417      3653 0000  SETUSE, 0
2420      3654 1010          TAD BINPTR
2421      3655 4515          JMS I SRD1
2422      3656 1010          TAD BINPTR
2423      3657 3011          DCA BINBLK
2424      3660 5653          JMP I SETUSE
2425      3661 7752          M26, -26
2426      3662 7716          M60A, -62
2427      3663 0000  RESETL, 0
2430      3664 1030          TAD AADR
2431      3665 0136          AND P6000

```

*get 1st word, current symbol*  
*get type of symbol & place in "TYPE"*  
*get 2nd word, current symbol*  
*get 3rd word*  
*reset to 1st word*



2432	3666	3046		DCA	ABANK
2433	3667	5663		JMP I	RESETL
2434	3670	0000	GETIN,	0	
2435	3671	4467		JMS I	GETCHR
2436	3672	3051		DCA	ITEM
2437	3673	1035		TAD	PASS
2440	3674	7710	CONSKP,	SPA	CLA
2441	3675	4471		JMS I	SYMLST
2442	3676	1051		TAD	ITEM
2443	3677	5670		JMP I	GETIN
2444	3700	7710	CONYES,	SPA	CLA
2445	3701	1300	COMMEN,	TAD	CONYES
2446	3702	3274		DCA	CONSKP
2447	3703	4270		JMS	GETIN
2450	3704	1122		TAD	M43
2451	3705	7640		SZA	CLA
2452	3706	5301		JMP	COMMEN
2453	3707	1325		TAD	CONREG
2454	3710	3274		DCA	CONSKP
2455	3711	5712		JMP I	BITT
2456	3712	2047	BITT,	BIT	
2457			/		
2460			/		
2461	3713	0000	RAND,	0	
2462	3714	0164		AND	CON
2463	3715	3164		DCA	CON
2464	3716	5713		JMP I	RAND
2465			/		
2466			/		
2467			/		
2470			/		
2471	3717	1035	ENDMS,	TAD	PASS
2472	3720	7710		SPA	CLA
2473	3721	5516		JMP I	RET1
2474	3722	5472		JMP I	MAINEX
2475			/		
2476			/		
2477			/		
2500	3723	0000	PGJS,	0	
2501	3724	1003		TAD	LISTWD
2502	3725	7710	CONREG,	SPA	CLA
2503	3726	5723		JMP I	PGJS
2504	3727	1736		TAD I	PCOT
2505	3730	1356		TAD	M77
2506	3731	3017		DCA	17
2507	3732	4500		JMS I	TYCARI
2510	3733	2017		ISZ	17
2511	3734	5332		JMP	,-2
2512	3735	5723		JMP I	PGJS
2513	3736	3522	PCOT,	PCONT	
2514			/		
2515			/		
2516			/		
2517	3737	0000	LNCK,	0	
2520	3740	2173		ISZ	SPCUNT
2521	3741	5343		JMP ,+2	
2522	3742	4207		JMS	UPLN
2523	3743	5737		JMP I	LNCK
2524	3744	0000	SPACK,	0	
2525	3745	3007		DCA	TEMP
2526	3746	1007		TAD	TEMP
2527	3747	7040		CMA	
2530	3750	1173		TAD	SPCUNT

/GET A CHARACTER *from input*

/SPA FOR NORMAL,SKP FOR ABBREVIATED!:

*Do "AND"*

/FINAL UPPER

/-(TEMP+1)

```

2531 3751 7500 P100, SMA /TOO FAR???
2532 3752 7240 CLA CMA
2533 3753 3173 DCA SPCUNT
2534 3754 1007 TAD TEMP
2535 3755 5744 JMP I SPACK
2536
2537 3756 7701 M77, -77
2540 /
2541 /
2542 /
2543 /
2544 /
2545 3757 0000 STOCHK, 0
2546 3760 1171 TAD SNUM
2547 3761 7040 CMA
2550 3762 1032 TAD PERMA
2551 3763 7710 SPA CLA
2552 3764 5757 JMP I STOCHK
2553 3765 1370 TAD P5
2554
2555 3766 4476 EQUERR, JMS I ERR1 /GIVE ERROR MESSAGE,
2556 3767 5771 JMP I EDEFIN
2557 /
2560 3770 0005 P5, 5
2561 3771 1416 EDEFIN, MAINSF
2562 /
2563 /
2564 /
2565 /
2566 EJECT
-

```

```

2567      /
2570      /
2571      /
2572      /
2573      /
2574      /ASSEMBLER PAGE16 !!!!
2575      *4001      /4000 IS THE JMP RET STORE IN LMODE.
2576      4001 3463      DISRE, DISRET
2577      *4002
2600      4002 1370      FSBLK, 1000+D7
2601      4003 0000      FSUNIT, 0
2602      4004 2400      AALPHA, ALPHA
2603      4005 7774      LTREAD, READ
2604      4006 0000      BUFIN, 0      /GETS NEXT BUFFER FROM INPUT UNIT.
2605      4007 4605      JMS I LTREAD
2606      4010 4175      BBLOCK
2607      4011 2377      ISZ BUFINZ
2610      4012 5606      JMP I BUFIN
2611      4013 0000      INIT, 0      /INITIALIZATION ROUTINE: CALLED AT BEGINNING OF EACH PASS.
2612      4014 4500      JMS I TYCARI
2613      4015 1202      TAD FSBLK
2614      4016 0374      AND L777
2615      4017 3377      DCA BUFINZ
2616      4020 1203      TAD FSUNIT
2617      4021 3375      DCA BBLOCK
2620      4022 1241      TAD P2270
2621      4023 3010      DCA BINPTR      /SET UP POINTER, SETUSE WILL SET BINBLK
2622      4024 4643      JMS I TOUSE      /CALL SET USE NOW.
2623      4025 1155      TAD P7400
2624      4026 3645      DCA I CHO
2625      4027 3642      DCA I WDH
2626      4030 1246      TAD P4400
2627      4031 3647      DCA I PTB
2630      4032 4206      JMS BUFIN
2631      4033 3037      DCA MODE      /RESET TO LMODE AND READ IN SYMBOL TABLE.
2632      4034 4605      JMS I LTREAD
2633      4035 4170      LTAB
2634      4036 7240      CLA CMA
2635      4037 3012      DCA CURLIN
2636      4040 5613      JMP I INIT
2637      4041 2400      P2270, 2000+D7+10
2640      4042 3351      WDH, WDHALF
2641      4043 3653      TOUSE, SETUSE
2642      4044 4337      USES, USEDNO
2643      4045 3354      CHO, CHRC
2644      4046 4400      P4400, 4400
2645      4047 3352      PTB, PTBUFP
2646      4050 5737      OCHECK, CHECKO
2647      4051 1011      RETURN, TAD BINBLK
2650      4052 4513      JMS I SRITIC
2651      4053 1244      TAD USES
2652      4054 3016      DCA 16
2653      4055 1013      TAD M40
2654      4056 3017      DCA 17
2655      4057 3644      DCA I USES
2656      4060 1416      TAD I 16
2657      4061 7710      SPA CLA
2660      4062 2644      ISZ I USES
2661      4063 2017      ISZ 17
2662      4064 5260      JMP ,+4
2663      4065 4763      JMS I RWRITE
2664      4066 4164      BINHDR
2665      4067 4601      JMS I DISRE

```

2666	4070	4650	JMS I	OCHECK	/CHECK FOR NO BINARY, ALSO GIVE CARRIAGE
2667					/RETURN AFTER ERROS MESSAGE, MUST GO
2670					/AFTER CALL TO DISRET
2671	4071	4604	JMS I	AALPHA	
2672	4072	4674	JMS I	PSTS	
2673	4073	5517	JMP I	MON	
2674	4074	3723	PSTS,	PGJS	
2675			/		
2676			/		
2677			/		
2700			/		
2701	4075	3733	KILBUF,	DCA I	PCOUNT
2702	4076	1731	TAD I	PINP	/ZERO THE COUNTER NOW
2703	4077	3732	DCA I	POUTP	/POSITION THE INPUT POINTER TO PATCH
2704	4100	3314	DCA	KLOOP	/THE OUTPUT POINTER
2705			/		/RESET C.R, CHECKER AFTER C.R, ABORT
2706			/		
2707			/		
2710			/		
2711			/		
2712	4101	4736	MONIT,	JMS I	MMMOVE
2713	4102	6201		CFD	0
2714	4103	7000		7000	
2715	4104	6211		CFD	10
2716	4105	7000		7000	
2717	4106	1000		1000	
2720	4107	1334	TAD	PL215	/GIVE AN EXTRA C.R,L,F FOR GOOD MEASURE
2721	4110	4401	JMS I	DECOUT	
2722	4111	1335	TAD	PL212	
2723	4112	4401	JMS I	DECOUT	
2724	4113	4401	JMS I	DECOUT	/GIVE A NULL CHARACTER IN CASE OF TAPE LIST OPTION
2725	4114	4404	KLOOP,	JMS I	CNTLPI
2726	4115	4541	JMS I	PCHECK	/CHECK FOR A C.R, TO TERMINATE THE OUTPUT
2727	4116	1733	TAD I	PCOUNT	
2730	4117	7640	SZA CLA		
2731	4120	5314	JMP	KLOOP	/WAIT UNTIL THE BUFFER IS EMPTY,
2732	4121	1330	TAD	PL17	
2733	4122	6664	LPR		
2734	4123	0000	0		
2735	4124	2000	ISZ	0	
2736	4125	4323	JMS	,-2	/WAIT FOR LPR TO TAPE EFFECT
2737	4126	6212	CIF	10	
2740	4127	5730	JMP I	,+1	
2741	4130	7777	PL17,	7777	
2742			/		
2743			/		
2744	4131	0722	PINP,	INP	
2745	4132	0705	POUTP,	OUPP	
2746	4133	0760	PCOUNT,	COUNT	
2747	4134	0215	PL215,	215	
2750	4135	0212	PL212,	212	
2751	4136	7200	MMMOVE,	7200	
2752			/		
2753			/		
2754			/		
2755	4137	1030	NOS,	TAD AADR	
2756	4140	0131	AND	P3777	
2757	4141	5347	JMP	PDLK	
2760	4142	2020	PERIOD,	ISZ ANY	
2761	4143	1037	TAD	MODE	
2762	4144	7700	SMA	CLA	
2763	4145	5352	JMP	LINKDT	
2764	4146	1030	TAD	AAADR	

2765	4147	4434	PDLK,	JMS I SGN
2766	4150	4504		JMS I IDX1
2767	4151	5503		JMP I B21
2770	4152	1030	LINKDT,	TAD AADR
2771	4153	0136		AND P6000
2772	4154	7041		CIA
2773	4155	1046		TAD ABANK
2774	4156	7640		SZA CLA
2775	4157	5337		JMP NOS
2776	4160	1030		TAD AADR
2777	4161	0144		AND P1777
3000	4162	5347		JMP PDLK
3001			/	
3002	4163	7775	RWRITE,	WRITE
3003			/	
3004	4164	0111	BINHDR,	DIALBINARY
3005	4165	0010		10
3006	4166	0057		D7+57=370
3007	4167	0001		1
3010			/	
3011	4170	0100	LTAB,	DIALUNIT
3012	4171	0036		36
3013	4172	0042		D6+42=300
3014	4173	0002		2
3015			/	
3016			/	
3017	4174	0777	L777,	777
3020			/	
3021	4175	0000	BBLOCK,	0
3022	4176	0011		11
3023	4177	0000	BUFINZ,	0
3024	4200	0001		1
3025			/	
3026			/	
3027				EJECT

```

3030
3031
3032
3033
3034
3035
3036
3037
3040
3041 4201 0000 SWRC, 0
3042 4202 1305 TAD SM370
3043 4203 0304 AND SL777
3044 4204 3317 DCA SWOUT
3045 4205 4610 JMS I WWRITE
3046 4206 4315 SIT
3047 4207 5601 JMP I SWRC
3050
3051 4210 7775 WWRITE, WRITE
3052 4211 0000 RSUB, 0
3053 4212 3227 DCA SOMEW
3054 4213 1164 TAD CON
3055 4214 3232 OCA SUBCON
3056 4215 1037 TAD MODE
3057 4216 7700 SMA CLA
3060 4217 5225 JMP LNKSUB
3061 4220 1227 TAD SOMEW
3062 4221 7041 CIA
3063 4222 1164 TAD CON
3064 4223 3164 RSUBRT, OCA CON
3065 4224 5611 JMP I RSUB
3066 4225 6141 LNKSUB, LINC
3067 LMODE
3070 0226 1020 LDA I
3071 0227 0000 SOMEW, 0
3072 0230 0017 COM
3073 0231 1120 ADA I
3074 0232 0000 SUBCON, 0
3075 0233 0002 MSC 2
3076 PMODE
3077 4234 5223 JMP RSUBRT
3100 4235 0000 RADD, 0
3101 4236 3252 DCA WHERE
3102 4237 1164 TAD CON
3103 4240 3254 DCA ADDCON
3104 4241 1037 TAD MODE
3105 4242 7700 SMA CLA
3106 4243 5250 JMP LNKADD
3107 4244 1252 TAD WHERE
3110 4245 1164 TAD CON
3111 4246 3164 RADDRT, DCA CON
3112 4247 5635 JMP I RADD
3113 4250 6141 LNKADD, LINC
3114 LMODE
3115 0251 1020 LDA I
3116 0252 0000 WHERE, 0
3117 0253 1120 ADA I
3120 0254 0000 ADDCON, 0
3121 0255 0002 MSC 2
3122 PMODE
3123 4256 5246 JMP RADDRT
3124
3125
3126

```

*c(CON) - c(AC)*

*c(CON) + c(AC)*

PSEUDO OP SETTER AND PAGER

```

3127 /
3130 /
3131 /ROUTINE PAGES IN PSEUDO OP PROCESSOR WITH NUMBER IN AC, PROCESSOR DOES THE REST.
3132 /FOR BK, PSNOPS ARE MADE INTO NOPS, AND PPSEUDO IS CHANGED,
3133 /
3134 4257 2273 PSUD07, ISZ OP1
3135 4260 2273 PSUD06, ISZ OP1
3136 4261 2273 PSUD05, ISZ OP1
3137 4262 2273 PSUD04, ISZ OP1
3140 4263 2273 PSUD03, ISZ OP1
3141 4264 2273 PSUD02, ISZ OP1
3142 4265 7300 PSUD01, CLA CLL
3143 4266 1273 TAD OP1
3144 4267 4674 JMS I PPSEUDO
3145 4270 3201 PAFTER, DCA PSRET
3146 4271 3273 DCA OP1
3147 4272 5601 JMP I PSRET
3150 4273 0000 OP1, 0
3151 PSRET=SWRC
3152 4274 5410 PPSEUDO, PSEUDO /PSEUDO + CORRECT ORIGIN
3153 4275 0000 SREAD1, 0
3154 4276 1305 TAD SM370 /SUBTRACT OFF THE EXTRANEIOUS CRAP
3155 4277 0304 AND SL777
3156 4300 3317 DCA SWOUT
3157 4301 4706 JMS I WREAD
3160 4302 4315 SIT
3161 4303 5675 JMP I SREAD1
3162 /
3163 4304 0777 SL777, 777
3164 4305 7410 SM370, -370
3165 /
3166 4306 7774 WREAD, READ
3167 4307 0000 POPUP1, 0 /PUT LAST ENTRY IN PUSH
3170 4310 7240 CLA CMA
3171 4311 1047 TAD POINT
3172 4312 3047 DCA POINT
3173 4313 1447 TAD I POINT
3174 4314 5707 JMP I POPUP1
3175 /
3176 4315 0111 SIT, DIALBINARY
3177 4316 0012 12
3200 4317 0000 SWOUT, 0
3201 4320 0001 1
3202 /
3203 /
3204 /
3205 /
3206 /
3207 /
3210 /
3211 4321 0000 UBITS, 0 /THIS ROUTINE SETS THE "IN USE" BITS IN THE HEADER BLOCK
3212 4322 1011 TAD BINBLK /GET THE IN USE BLOCK POINTER
3213 4323 1330 TAD FACTOR /CONVERT TO AN ABSOLUTE MEMORY ADDRESS
3214 4324 3007 DCA TEMP /STORE AWAY NOW
3215 4325 7240 CLA CMA /SET THE HEADER BLOCK BITS ALL ONE NOW
3216 4326 3407 DCA I TEMP /IN THEY GO
3217 4327 5721 JMP I UBITS /RETURN TO THE CALLER, ALL IS WELL
3220 /
3221 /
3222 4330 1750 FACTOR, BLKUSE=2000-D7 /CORE HEADER BLOCK MAPPER,
3223 /
3224 /
3225 /

```

```

3226 /
3227 /
3230 /
3231 /
3232 /
3233 /
3234 /
3235 /
3236 /
3237 /
3240 /
3241 /
3242 /
3243 4331 0100 VSAVE, DIALUNIT /THE ACTUAL DIAL AREA
3244 4332 0015 15 /LOCATIONS 6400-6777
3245 4333 0025 SCRATCH /A SCRATCH AREA ON THE TAPE
3246 4334 0001 1 /1 BLOCK IN OR OUT,
3247 /
3250 /
3251 /
3252 /
3253 /
3254 /
3255 /
3256 /
3257 /
3260 /
3261 /
3262 /
3263 /
3264 /
3265 /
3266 /
3267 /
3270 /
3271 /
3272 /
3273 /
3274 /
3275 /
3276 /
3277 4337 0000 USEDNO, 0 *4337
3300 *4340
3301 BLKUSE =,
3302 4340 0000 0
3303 4341 0000 0
3304 4342 0000 0
3305 4343 0000 0
3306 4344 0000 0
3307 4345 0000 0
3310 4346 0000 0
3311 4347 0000 0
3312 4350 0000 0
3313 4351 0000 0
3314 4352 0000 0
3315 4353 0000 0
3316 4354 0000 0
3317 4355 0000 0
3320 4356 0000 0
3321 4357 0000 0
3322 4360 0000 0
3323 4361 0000 0
3324 4362 0000 0

```



3325	4363	0000	0
3326	4364	0000	0
3327	4365	0000	0
3330	4366	0000	0
3331	4367	0000	0
3332	4370	0000	0
3333	4371	0000	0
3334	4372	0000	0
3335	4373	0000	0
3336	4374	0000	0
3337	4375	0000	0
3340	4376	0000	0
3341	4377	0000	0
3342			/
3343			/
3344			/
3345			/
3346			/
3347			/
3350			/
3351			/
3352			/
3353			/
3354			/
3355			/

EJECT

3356 /  
3357 /  
3360 /  
3361 /  
3362 /  
3363 /  
3364 /  
3365 /  
3366 /  
3367 /  
3370 /  
3371 /  
3372 /  
3373 /  
3374 /  
3375 /  
3376 /  
3377 /  
3400 /  
3401 /  
3402 /  
3403 /  
3404 /  
3405 /  
3406 /  
3407 /  
3410 /  
3411 /  
3412 /  
3413 /  
3414 /  
3415 /  
3416 /

END OF ASSEMTWO, FETCH ASSEM3.

CHAIN "ASSEM3"

```
0000      *20
0001      /      PMODE
0002      /
0003      /
0004      /
0005      /
0006      /
0007      /
0010      /
0011      /      BEGINNING OF ASSETHREE
0012      /
0013      /
0014      /
0015      /
0016      /
0017      /
0020      /
0021      /
0022      /
0023      /
0024      /
0025      /
0026      /
0027      /
0030      /
0031      /
0032      /      EJECT
-
```

```

0033      /      M A I N   I N I T I A L I Z A T I O N   O F   T H E   A S S E M B L E R
0034      /
0035      /
0036      /
0037      /
0040      /
0041      /
0042      *5000
0043      5000  7200  BEGNLI,  CLA      /ENTRY IF LIST IS DESIRED.
0044      5001  7410      SKP
0045      5002  7240  BEGNAS,  CLA CMA /ENTRY IF JUST ASSEMBLY.
0046      5003  3003      DCA      LISTWD /SAVE LIST STATUS CONDITION,
0047      5004  1621      TAD I    P4775 /4775 CONTAINS STARTING LINE NUM. OF LISTING
0050      5005  3620      DCA I    PJSTART
0051      5006  1622      TAD I    P4776 /4776 CONTAINS ENDING LINE NUM, STASH IT AWAY PERMANENTLY.
0052      5007  3617      DCA I    PJEND
0053      5010  1003      TAD      LISTWD
0054      5011  7650      SNA CLA
0055      5012  5216      JMP      ,+4
0056      5013  1214      TAD      ,+1
0057      5014  7000      JBNOP,   NOP
0060      5015  3637      DCA I    PJNOP      /IF NO LIST THEN FIX JBTEST SO IT CAN NEVER LIST OUT.
0061      5016  5240      JMP      PJNOP+1
0062      5017  1734      PJEND,   JEND
0063      5020  1733      PJSTART,  JSTART
0064      5021  4775      P4775,   4775
0065      5022  4776      P4776,   4776
0066      5023  4774      P4774,   4774
0067      5024  3042      BANOP1,  ABNOP1
0070      5025  3043      BANOP2,  ABNOP2
0071      5026  3044      BANOP3,  ABNOP3
0072      5027  3045      BANOP4,  ABNOP4
0073      5030  3700      BANOP5,  CONYES
0074      5031  7610      BANDO,   SKP CLA
0075      5032  1374      BLTAD,  1200+M7TWO-ENTS
0076      5033  2107      BLTAD1, NOTAB1
0077      5034  2124      BLTAD2, NOTAB2
0100      5035  7770      BLM10,  -10
0101      5036  2535      BLPM22, M22
0102      5037  1730      PJNOP,   JNOP
0103      5040  2623      ISZ I   P4774      /4774=7777 IF QUICK LIST,
0104      5041  5262      JMP     LISREG     /NO QUICK LIST,
0105      5042  1214      TAD     JBNOP      /CHANGE LIST ROUTINE FOR QL BY ALL FOLLOWING CRAP.
0106      5043  3624      DCA I   BANOP1
0107      5044  1214      TAD     JBNOP
0110      5045  3625      DCA I   BANOP2
0111      5046  1214      TAD     JBNOP
0112      5047  3626      DCA I   BANOP3
0113      5050  1214      TAD     JBNOP
0114      5051  3627      DCA I   BANOP4
0115      5052  1231      TAD     BANDO
0116      5053  3630      DCA I   BANOP5
0117      5054  1232      TAD     BLTAD
0120      5055  3633      DCA I   BLTAD1
0121      5056  1232      TAD     BLTAD
0122      5057  3634      DCA I   BLTAD2
0123      5060  1235      TAD     BLM10
0124      5061  3636      DCA I   BLPM22
0125      5062  1473      LISREG, TAD I     INAS
0126      5063  3472      DCA I   MAINEX     /INITILIZE TO PASS1,
0127      5064  6141      LINC
0130      LMODE
0131      1065  0641      LDF      1      /SET UP PRINTER CHECK

```

```

0132      1066 1020      LDA I
0133      1067 5731      TYPO+3202
0134      1070 1040      STA
0135      1071 2530      TYPO+1
0136      1072 1020      LDA I
0137      1073 6244      LPTTEST
0140      1074 1040      STA
0141      1075 2531      TYPO+2
0142      1076 0643      LDF      3
0143      1077 1000      LDA
0144      1100 0777      777
0145      1101 4003      STC      FSUNIT&1777
0146      1102 1000      LDA
0147      1103 0002      FSBLK&1777
0150      1104 1560      BCL I
0151      1105 7000      -777
0152      1106 4002      STC      FSBLK&1777
0153      1107 0002      PDP
0154      PMODE
0155      5110 6212      CIF      10
0156      5111 4730      JMS I  IMMOVE
0157      5112 6211      CDF      10
0160      5113 7000      7000
0161      5114 6201      CDF      0
0162      5115 7000      7000
0163      5116 1000      1000
0164      5117 4731      JMS I  IMREAD
0165      5120 5133      ITABIN
0166      5121 1072      TAD      MAINEX
0167      5122 3460      DCA I  INIT1
0170      5123 1326      TAD      IM215
0171      5124 4727      JMS I  IMTYPO
0172      5125 5732      JMP I  IMINIT
0173      /START THE ASSEMBLER GOING RIGHT NOW...
0174      /
0175      /
0176      /
0177      5126 0215  IM215, 215
0200      5127 2527  IMTYPO, TYPO
0201      5130 7200  IMMOVE, 7200
0202      5131 7774  IMREAD, READ
0203      5132 4014  IMINIT, INIT+1
0204      /
0205      /
0206      /
0207      5133 0100  ITABIN, DIALUNIT
0210      5134 0013      13
0211      5135 0026      FUDGE1
0212      5136 0002      2
0213      /
0214      /
0215      /
0216      /
0217      /
0220      EJECT

```

```

/NOW CHANGING TTY ROUTINE TO CALL LINE PRINTER CHECK ROUTINE,
/TYPE=2571+3202=5773(JMP I TYPO+2)

```

```

/PREPARE TO MOVE DOWN THEREAD ROUTINES,

```

```

/FAKE START OF ASSEMBLY BY PLACING
/STARTING ADDRESS OF ASSEMBLER IN IT
/GET A C.R. TO INITIALIZE THE SYSTEM
/AND SEND IT DIRECTLY TO THE OUTPUTER
/AND BY JUMPING TO THE SECOND LOC OF INIT

```

```

/C.R.

```

```

0221 /
0222 / PSEUDO OP PROCESSOR, IT REALLY IS ORIGINATED AT
0223 / 5000 FOR 4K, BUT IT WOULD THEN OVERLAY THE INITIALIZATION ROUTINE. (AT ASSEMBLY).
0224 /THUS ITS ASSEMBLED AT 7000 BUT PFUDGE MAKES THE INTERPAGE REFERENCE LOOK LIKE IT S AT 5000.
0225 / THE 8K VERSION IS REALLY ORIGINATED AT 7000, I GENERALLY CHANGE THE INTERPAGE
0226 /REFERENCES BY HAND(THERE S ABOUT 6 ON THIS PAGE AND 3 ON THE NEXT PAGE.)
0227 /ALL INTERBANK REFERENCE HAVE A
0228 /TO THE DATA ITEMS,
0230 /REMEMBER, THIS IS FINE AS IS FOR "FUDGE4". FOR FUDGE5 ADD 2000 TO INTERBAGE REFERENCES,
0231 /
0232 /
0233 /
0234 /
0235 /
0236 /
0237 /
0240 *5400 /NEW LOCATION OF PSEUDO PROCESSOR
0241 /
0242 /
0243 /
0244 / MAIN PSEUDO OP PROCESSOR, PAGED IN!
0245 /
0246 /
0247 /
0250 5400 1202 ACCOUNT, 1202 /"JB" ON THE TAPE; IN CORE IT S A TEMPORARY
0251 5401 4377 GETVAL, 4360+VERSION /VERSION NUMBER ON TAPE, IN CORE IT S
0252 /A SUBROUTINE ENTRY,
0253 /NO.7
0254 / (CHECKS UNIT 1 TO SEE
0255 /IF PRESENT AND IF IT IS USES UNIT
0256 /1 TO READ IN THIS PAGE
0257 /
0260 5402 4477 JMS I EXPR1
0261 5403 1020 TAD ANY
0262 5404 7650 SNA CLA
0263 5405 5303 JMP ASSNO
0264 5406 1033 TAD EVAL
0265 5407 5601 JMP I GETVAL
0266 /
0267 /GETVAL EVALUATES THE EXPRESSION TO THE RIGHT OF A PSEUDO OP,
0270 /IF NO EXPRESSION THEN IT EXITS,
0271 /BACK TO THE MAIN ASSEMBLER WITHOUT DOING ANYTHING,
0272 /
0273 /
0274 /
0275 /
0276 /
0277 5410 4270 PSEUDO, PAFTER /RETURN IF OVERLAYED BY ITSELF,
0300 5411 1214 TAD PJMP
0301 5412 3213 DCA ,+1
0302 5413 5214 JMP ,+1 /OVERLAYED BY PSEUDO NO,
0303 5414 5215 PJMP, JMP ,+1 /MAIN TABLE POINTER
0304 5415 5224 JMP NASSIF /EVIL IF SPELLED RIGHT
0305 5416 5225 JMP ZASSIF
0306 5417 5226 JMP MASSIF
0307 5420 5353 JMP SYML0D
0310 5421 5316 JMP AEJECT
0311 5422 5333 JMP SYMSAV
0312 5423 5235 JMP SKIPAS
0313 /
0314 /
0315 /END OF JUMP TABLE, PSEUDO WAS CALLED WITH PSEUDO OP NUMBER IN AC,
0316 /
0317 /

```

```

0320 /
0321 /
0322 /
0323 5424 1305 NASSIF, TAD AMM10
0324 5425 1013 ZASSIF, TAD M40
0325 5426 1320 MASSIF, TAD L7710
0326 5427 3231 DCA ,+2 /STORE CORRECT SKP AFTER EVALUATING EXPR.
0327 5430 4201 JMS GETVAL
0330 5431 0000 0
0331 5432 5303 JMP ASSNO /WRONG SKIP CONDITION. ASSEMBLE NEXT.
0332 5433 7240 CLA CMA /OO AN ASMSKP 1.
0333 5434 5241 JMP ASSYIN
0334 5435 4201 SKIPAS, JMS GETVAL
0335 5436 7041 CIA
0336 5437 7450 SNA /NUMBER TO BE SKKIPED. IF ZERO EXIT.
0337 5440 5303 JMP ASSNO
0340 5441 3200 ASSYIN, DCA ACCOUNT
0341 5442 1051 TAD ITEM
0342 5443 1122 TAD M43 /WAS DOLLAR TERMINATOR,
0343 5444 7640 SZA CLA
0344 5445 7240 CLA CMA /NO, ADD 1 TO SKIP BECAUSE OF END OF THIS STATEMENT.
0345 5446 1200 TAD ACCOUNT
0346 5447 3200 DCA ACCOUNT
0347 5450 1312 TAD PACHECK
0350 5451 3711 DCA I PSWITCH
0351 5452 1306 TAD ASEND
0352 5453 3714 DCA I PDOLLAR
0353 5454 1307 TAD AMAINPS
0354 5455 3310 DCA PMAINSA
0355 5456 5657 JMP I ,+1 /AFTER SETTING SWITHCES EXIT TO PICK UP NEXT STATEMENT.
0356 5457 2714 AFDRT, FORT
0357 5460 7300 ACHECK, CLA CLL
0360 5461 1051 TAD ITEM
0361 5462 1122 TAD M43
0362 5463 7650 SNA CLA
0363 5464 5267 JMP ASPAST
0364 5465 4504 JMS I IDX1
0365 5466 5261 JMP , -5 /WAIT FOR END OF THIS LINE.
0366 5467 2200 ASPAST, ISZ ACCOUNT
0367 5470 5710 JMP I PMAINSA /NOT DONE YET, PICK UP NEXT STATEMENT TO SKIP.
0370 5471 1313 ASSRST, TAD PDCAL
0371 5472 3711 DCA I PSWITCH
0372 5473 1315 TAD PENDMS
0373 5474 3714 DCA I PDOLLAR
0374 5475 1310 TAD PMAINSA
0375 5476 5610 JMP I PSEUDO /RESET SWITCHES AND EXIT.
0376 5477 7300 APAEND, CLA CLL
0377 5500 1315 TAD PENDMS
0400 5501 3310 DCA PMAINSA
0401 5502 5271 JMP ASSRST /END OF MANUSCRIPT
0402 /
0403 /
0404 /
0405 /
0406 /
0407 /
0410 /
0411 5503 1257 ASSNO, TAD AFDRT
0412 5504 5610 JMP I PSEUDO /GENERAL EXIT.
0413 /
0414 /
0415 /
0416 /

```

```

0417 5505 7770 AMM10, -10
0420 5506 5477 ASEND, APAEND
0421 5507 1504 AMAINPS, MAINSA
0422 5510 1504 PMAINSA, MAINSA
0423 5511 1575 PSWITCH, PSINTER
0424 5512 5460 PACHECK, ACHECK
0425 5513 1426 PDOCAL, DOCAL
0426 5514 2173 PDOLLAR, FINE ND
0427 5515 3717 PENDMS, ENDMS
0430 /
0431 /
0432 /
0433 /
0434 5516 4477 AEJECT, JMS I EXPRI /JUST TO SCAN TILL END OF LINE,
0435 5517 4465 JMS I PASSEK /GET THE PASS NO.
0436 5520 7710 L7710, SPA CLA /ALWAYS SKIPS BECAUSE AC=0
0437 5521 5303 JMP ASSNO /NOT LIST OR NOT PASS2
0440 5522 1537 TAD I PM60A /IF LP THEN M60=-140
0441 5523 1331 TAD AEP62 /SEE IF GREATER THAN 62
0442 5524 7700 SMA CLA /IS PRINTER THERE???
0443 5525 5303 JMP ASSNO /NOPE. LINE PRINTER ISN T THERE
0444 5526 7240 CLA CMA /YES. SET PAGE POINTER TO EJECT,
0445 5527 3732 DCA I AEPONT
0446 5530 5303 JMP ASSNO
0447 /
0450 /
0451 5531 0062 AEP62, 62
0452 5532 3522 AEPONT, PCONT
0453 /
0454 /
0455 /
0456 /
0457 /
0460 /
0461 5533 4201 SYMSAV, JMS GETVAL
0462 5534 1035 TAD PASS
0463 5535 7010 RAR
0464 5536 7620 SNL CLA
0465 5537 5303 JMP ASSNO /INCORRECT PASS NO,!!
0466 5540 4772 JMS I VOUT /SAVE 6400 FOR A SECOND,
0467 5541 1027 TAD SEND /NUMBER OF DEFINED SYMBOLS,
0470 5542 3751 DCA I VL6777
0471 5543 4747 JMS I YWRITE
0472 5544 5566 YP1
0473 5545 4773 JMS I VIN /RESTORE 6400 NOW,
0474 5546 5752 JMP I PV8MOVE
0475 /
0476 5547 7775 YWRITE, WRITE
0477 5550 7774 YREAD, READ
0500 5551 6777 VL6777, 6777
0501 5552 5600 PV8MOVE, V8MOVE
0502 5553 1035 SYMLOD, TAD PASS
0503 5554 7640 SZA CLA
0504 5555 5224 JMP NASSIF /DO NOT LOAD SYMBOLS IF PASS2
0505 5556 4772 JMS I VOUT /PRESERVE 6400 NOW
0506 5557 4750 JMS I YREAD
0507 5560 5566 YP1
0510 5561 1751 TAD I VL6777
0511 5562 3027 DCA SEND /GET NUMBER OF SAVED SYMBOLS
0512 5563 4773 JMS I VIN /NOW RESTORE 6400
0513 5564 5765 JMP I VINIT /NOW READ IN THE SYMBOL TABLE
0514 5565 5604 VINIT, VVINIT
0515 /

```



0516			/		
0517			/		
0520	5566	0111	YP1,	DIALBINARY	
0521	5567	0015		15	
0522	5570	0077		FUDGE2	
0523	5571	0001		1	
0524			/		
0525			/		
0526			/		
0527			/		
0530			/		
0531			/		
0532			/		
0533			/		
0534			/		
0535			/		
0536	5572	0773	VOUT,	VPRSRV	/POINTS TO THE PRESERVE ROUTINE
0537	5573	0572	VIN,	VRSTR	/POINTS TO THE RESTORE ROUTINE
0540			/		
0541			/		
0542			/		
0543			/		
0544			/		
0545			/		
0546			/		
0547			/		
0550			/		
0551			/		
0552			/		
0553			/		
0554				EJECT	

```

0555          *5600
0556          /
0557      5600 4607 V8MOVE, JMS I  VWRITE
0560      5601 5611          VTAB
0561          /
0562      5602 5603 VCLEAN, JMP I  VASSNO
0563          /
0564      5603 5503 VASSNO, ASSNO
0565          /
0566          /
0567      5604 4610 VVINIT, JMS I  VREAD
0570      5605 5611          VTAB
0571      5606 5202          JMP    VCLEAN
0572          /
0573          /
0574          /
0575      5607 7775 VWRITE, WRITE
0576      5610 7774 VREAD,  READ
0577          /
0600          /
0601          /
0602      5611 0111 VTAB,   DIALBINARY
0603      5612 0020          20
0604      5613 0060          BOOUT
0605      5614 0016          16
0606          /
0607          /
0610          /
0611          /
0612          /
0613          /
0614          /
0615          /
0616          /
0617          /
0620      5615 4724 OUTPUT, JMS I  OGTVAL
0621      5616 3254          DCA   OPUT
0622      5617 1035          TAD   PASS
0623      5620 7640          SZA  CLA
0624      5621 5725          JMP  I  OASSNO
0625      5622 1254          TAD   OPUT
0626      5623 7510          SPA
0627      5624 5306          JMP  OBSET
0630      5625 0326          AND  OL17
0631      5626 3333          DCA  OUNIT
0632      5627 3335          DCA  OBLOCK
0633      5630 1331          TAD  OL6400
0634      5631 3330          DCA  OLOC
0635      5632 7240          CLA  CMA
0636      5633 6141          LINC
0637          LMODE
0640      1634 0460          SNS  I  0
0641      1635 0441          SNS  1
0642      1636 0011          CLR
0643      1637 0462          SNS  I  2
0644      1640 0443          SNS  3
0645      1641 0011          CLR
0646      1642 0464          SNS  I  4
0647      1643 0445          SNS  5
0650      1644 0011          CLR
0651      1645 0002          PDP
0652          PHODE
0653      5646 7040          CMA

```

```

/THIS ROUTINE ALLOWS OPTIONAL TAPE OUTPUT
/SAVE FOR A SECOND
/GET THE PASS NUMBER
/IS IT 1
/NOPE, IGNORE
/RESET THE USERS VALUE,
/IF POSITIVE THEN OUTPUT
/IF NEGATIVE THEN READ IN BIT TABLE
/JUST GET THE UNIT NUMBER

/CLEAR THE BLOCK TO 0
/RESET THE LOCATION COUNTER TO 6400
/WHICH IS THE BUFFER AREA
/SET UP THE TEST TO FOLLOW

```

```

/TEST FOR BOTH
/SWITCHES 0 AND 1 UP

/AND SO ON DOWN THE LINE

```

0654	5647	7640	SZA CLA			
0655	5650	5725	JMP I	OASSNO	/SWITCHES NOT UP, IGNORE REQUEST	
0656	5651	1327	TAD	OPPOINT	/RESET DECCOUT TO POINT TO HERE	
0657	5652	3001	DCA	DECCOUT		
0660	5653	5725	JMP I	OASSNO	/NOW RETURN TO THE USER,	
0661			/			
0662			/			
0663			/			
0664			/			
0665	5654	0000	OPUT,	0		
0666	5655	7450	SNA			
0667	5656	5261	JMP	OEND		
0670	5657	4267	JMS	OOPUT		
0671	5660	5654	JMP I	OPUT		
0672			/			
0673	5661	4267	OEND,	JMS OOPUT	/PUT IN A ZERO WORD	
0674	5662	1330	TAD	OLOC		
0675	5663	0332	AND	OL377	/CHOP OFF THE HIGH BITS NOW, JUST LEAVE THE POSITION BITS,	
0676	5664	7650	SNA CLA			
0677	5665	5654	JMP I	OPUT		
0700	5666	5261	JMP	OEND		
0701			/			
0702			/			
0703			/			
0704			/			
0705	5667	0000	OOPUT,	0		
0706	5670	3730	DCA I	OLOC		
0707	5671	1330	TAD	OLOC		
0710	5672	7001	IAC			
0711	5673	0332	AND	OL377		
0712	5674	1331	TAD	OL6400		
0713	5675	3330	DCA	OLOC		
0714	5676	1330	TAD	OLOC		
0715	5677	0332	AND	OL377	/CHOP OFF THE BAD BITS,	
0716	5700	7640	SZA CLA			
0717	5701	5667	JMP I	OOPUT		
0720	5702	4607	JMS I	VWRITE		
0721	5703	5733	OUNIT			
0722	5704	2335	ISZ	OBLOCK		
0723	5705	5667	JMP I	OOPUT		
0724			/			
0725			/			
0726			/			
0727			/			
0730			/			
0731			/			
0732			/			
0733	5706	7200	OBSET,	CLA	/ALSO POINTS TO MOVE ROUTINE	
0734	5707	4610	JMS I	VREAD	/READ IN THE OLD HEADER BLOCK	
0735	5710	5720	OBIN			
0736	5711	4706	JMS I	OBSET	/MOVE DOWN THE HEADER BLOCK NOW	
0737	5712	6201	COF	0		
0740	5713	5337	5337			
0741	5714	6201	COF	0		
0742	5715	4337	4337			
0743	5716	0041	41			
0744	5717	5725	JMP I	OASSNO	/AND RETURN TO THE USER	
0745			/			
0746			/			
0747			/			
0750			/			
0751			/			
0752			/			

```

0753      /
0754      /
0755      /
0756      5720 0111 0BIN, 111
0757      5721 0012      12
0760      5722 0057      447-370
0761      5723 0001      1
0762      /
0763      /
0764      /
0765      /
0766      /
0767      /
0770      /
0771      /
0772      /
0773      /
0774      /
0775      /
0776      /
0777      /
1000      /
1001      5724 5401 0GTVAL, GETVAL
1002      5725 5503 0ASSNO, ASSNO
1003      5726 0017 0L17, 17
1004      5727 5654 0POINT, OPUT
1005      5730 6400 0LOC, 6400
1006      5731 6400 0L6400, 6400
1007      5732 0377 0L377, 377
1010      /
1011      5733 0000 0UNIT, 0
1012      5734 0015      15
1013      5735 0000 0BLOCK, 0
1014      5736 0001      1
1015      /
1016      /
1017      /
1020      /
1021      /
1022      /
1023      /
1024      /
1025      /
1026      /
1027      /
1030      /
1031      /
1032      5737 0000 0CHECKO, 0
1033      5740 1776      TAD I 0CUSES
1034      5741 7640      SZA CLA
1035      5742 5351      JHP 0CCRLF
1036      /
1037      5743 1353 0CDOIT, TAD 0CPNT
1040      5744 7450      SNA
1041      5745 5351      JHP 0CCRLF
1042      5746 4401      JMS I 0DCOUT
1043      5747 2343      ISZ 0CDOIT
1044      5750 5343      JHP 0CDOIT
1045      /
1046      5751 4500 0CCRLF, JMS I TYCARI
1047      5752 5737      JHP I 0CHECKO
1050      /
1051      /

```

/15=6400 FOR THE BUFFER AREA

```

/THIS ROUTINE CHECKS FOR NO BINARY OUTPUT,
/GET THE NUMBER OF BLOCKS OF OUTPUT,
/AND THERE?
/YEP, JUST GIVE A C.R.L.F AND RETURN TO THE CALLER

/GET A CHARACTER FROM THE MESSEGER,
/ZERO = THATS ALL FOLKS
/GIVE THE LINEFEED NOW
/OUT GOES THE CHARACTER NOW
/BOP TO THE NEXT CHARACTER,
/GO GET THE NEXT CHARACTER

/GIVE THE CARRIGE RETURN NOW
/RETURN TO THE CALLER NOW

```

1052		/			
1053		/			
1054	5753	0254	OCPNT,	254	/,
1055	5754	0240		240	/
1056	5755	0316		316	/N
1057	5756	0317		317	/O
1060	5757	0240		240	/
1061	5760	0302		302	/B
1062	5761	0311		311	/I
1063	5762	0316		316	/N
1064	5763	0301		301	/A
1065	5764	0322		322	/R
1066	5765	0331		331	/Y
1067	5766	0240		240	/
1070	5767	0317		317	/O
1071	5770	0325		325	/U
1072	5771	0324		324	/T
1073	5772	0320		320	/P
1074	5773	0325		325	/U
1075	5774	0324		324	/T
1076	5775	0000		0	
1077		/			
1100		/			
1101		/			
1102	5776	4337	OCUSES, USEDNO		/POINTS TO THE NUMBER OF BINARY BLOCKS USED,
1103		/			
1104		/			
1105		/			
1106		/			
1107		/			
1110		/			
1111		/			
1112		/			
1113		/			
1114		/			
1115		/			
1116		/			
1117		/			
1120		/			
1121		/			
1122		/			
1123		/			
1124		/			
1125		/			
1126		/			
1127		/			
1130		/			
1131		/	EJECT		

```

1132          / LINE PRINTER ROUTINE
1133          /
1134          /
1135          /
1136          /
1137          /
1140      6000 0000 PRINT, 0 *6000 /THIS ROUTINE LOOKS
1141      6001 1151 TAD M215 /SORT OF LINE A TTY, TAD CHAR; JMS PRINT,
1142      6002 7450 SNA /IT HANDLES CR AND LF,
1143      6003 5210 JMP CRFOUND /IS IT CARRIAGE RETURN,
1144      6004 1154 TAD P215 /NO!
1145      6005 6661 LSD /WAIT FOR CLEAR SIGNAL,
1146      6006 5241 JMP LPBACK /LINE PRINTER IS BUSY, BACK SPACE 1 CHAR
1147      6007 5640 JMP I PCLP
1150          /
1151      6010 1235 CRFOUND, TAD SW1
1152      6011 3201 DCA PRINT+1
1153      6012 3306 DCA NUM /SET TOCHECK FOR LF
1154      6013 5600 JMP I PRINT
1155      6014 3234 LFTST, DCA TEMP1
1156      6015 1234 TAD TEMP1
1157      6016 1305 TAD M212 /IS IT A LINEFFED.
1160      6017 7650 SNA CLA
1161      6020 5232 JMP LFF
1162      6021 1234 TAD TEMP1
1163      6022 1151 TAD M215
1164      6023 7650 SNA CLA
1165      6024 5233 JMP LFF2
1166      6025 1236 TAD SW2 /NOT AN LF OR CR, NEW LINE, OUTPUT LAST,
1167      6026 3201 DCA PRINT+1
1170      6027 7240 CLA CMA
1171      6030 1306 TAD NUM
1172      6031 5637 JMP I PCFIG
1173          /
1174      6032 2306 LFF, ISZ NUM /LF, BOP UP LF COUNT,
1175      6033 5600 LFF2, JMP I PRINT
1176          /
1177          /
1200          /
1201      6034 0000 TEMP1, 0
1202      6035 5214 SW1, JMP LFTST
1203      6036 1151 SW2, TAD M215
1204          /
1205          /
1206          /
1207          /
1210          /
1211          /
1212      6037 6057 PCFIG, ANLXE
1213      6040 6054 PCLP, ANLXC
1214          /
1215          /
1216          /
1217          /
1220          /
1221      6041 2700 LPBACK, ISZ I LCOUNT /INCREMENT THE COUNTER BY 1
1222      6042 7240 CLA CMA /-1 TO DECREMENT THE POINTER
1223      6043 1701 TAD I LOUPT
1224      6044 3701 DCA I LOUPT
1225      6045 1302 TAD LFIRST /COMPARE AGAINST LOWER LIMIT
1226      6046 1701 TAD I LOUPT
1227      6047 7650 SNA CLA
1228      6050 1303 TAD LBAD /ITS TOO FAR, COMPENSTATE TO TOP OF BUFFER
1230      6051 1701 TAD I LOUPT

```

```

1231      6052 3701          DCA I  LOU TP
1232      6053 5600          JMP I  PRINT
1233      /
1234      /
1235      /
1236      /
1237      /
1240      6054 6656  ANLXC, LCF!LLB
1241      6055 7200          CLA
1242      6056 5600          JMP I  PRINT
1243      /
1244      6057 0157  ANLXE, AND   P7
1245      6060 7640  M140, SZA  CLA
1246      6061 1157          TAD   P7
1247      6062 1304          TAD  L10
1250      6063 6652          LCF
1251      6064 6664          LPR
1252      6065 7200  LPRENT, CLA
1253      6066 3306          DCA   NUM
1254      6067 1234          TAD  TEMP1
1255      6070 5201          JMP  PRINT+1
1256      /
1257      /
1260      6071 6666  LP00C, LPR!LCB
1261      6072 5255          JMP  ANLXC+1
1262      /
1263      6073 7640  LP00E, SZA  CLA
1264      6074 7305          CLA  CLL IAC RAL
1265      6075 1153          TAD  P212
1266      6076 6666          LPR!LCB
1267      6077 5265          JMP  LPRENT
1270      /
1271      /
1272      6100 0760  LCOUNT, COUNT
1273      6101 0705  LOU TP,  OUP T
1274      6102 1671  LFIRST, -FIRST+1
1275      6103 0270  LBAD,   BAD-FIRST+1-1
1276      /
1277      /
1300      6104 0010  L10,   10
1301      6105 7566  M212,  -212
1302      /
1303      /
1304      /
1305      /
1306      /
1307      /
1310      /
1311      /
1312      /
1313      6106 0000  NUM,   0
1314      6107 0000  PRINIT, 0
1315      /
1316      /
1317      /
1320      /
1321      /
1322      /
1323      /
1324      /
1325      FIRST=,          /DEFINE THE START OF THE BUFFER
1326      BAD=6400        /AND THE END+1
1327      /

```

```

1330 /
1331 //
1332 //
1333 //
1334 PAGE
1335 /
1336 //
1337 //
1340 //
1341 //
1342 //
1343 6200 1305 LOK, TAD L17 /LP IS THERE, EJECT TO START AS,
1344 6201 6652 LCF
1345 6202 6664 LPR
1346 6203 7200 CLA
1347 6204 1311 TAD M154 /SET LINE COUNTER FOR 154 COLUMNS WIDE.
1350 6205 3706 DCA I PC1
1351 6206 1706 TAD I PC1
1352 6207 3707 DCA I PC2
1353 /
1354 6210 1335 LOK0, TAD SYMFIX
1355 6211 3736 DCA I SYMOVR
1356 /
1357 6212 1233 LOK1, TAD R1 /RESET TYPO TO LP OR TTY ROUTINE.
1360 6213 3626 DCA I PR1
1361 6214 1235 TAD R2
1362 6215 3627 DCA I PR2
1363 6216 1237 TAD R3
1364 6217 3630 DCA I PR3
1365 6220 1241 TAD R4
1366 6221 3631 DCA I PR4
1367 6222 1243 TAD R5
1370 6223 3632 DCA I PR5
1371 6224 1154 TAD P215
1372 6225 5626 JMP I ,+1
1373 6226 2530 PR1, TYPO+1
1374 6227 2531 PR2, TYPO+2
1375 6230 2532 PR3, TYPO+3
1376 6231 2533 PR4, TYPO+4
1377 6232 2534 PR5, TYPO+5
1400 6233 4732 R1, JMS I LOK+TYPO-TYBASE+3
1401 6234 6041 TSF
1402 6235 7410 R2, SKP
1403 6236 5330 JMP LOK+TYPO-TYBASE+1
1404 6237 6000 R3, PRINT
1405 6240 6046 TLS
1406 6241 5727 R4, JMP I LOK+TYPO-TYBASE
1407 6242 7200 CLA
1410 6243 5727 R5, JMP I LOK+TYPO-TYBASE
1411 /
1412 /
1413 6244 7300 LPTEST, CLA CLL
1414 6245 1135 TAD M4 /WAIT FOR PRINTER TEST
1415 6246 3313 DCA PT2
1416 6247 3312 DCA PT1
1417 6250 6652 LCF
1420 6251 6662 TEST, LCB /CLEAR BUFFER, IF LP THERE FLAG RAISES IN 300 MILLSEC.
1421 6252 6661 LSD
1422 6253 7410 SKP
1423 6254 5200 JMP LOK /FLAG SI UP, LP THERE, WHAT A LUCKY BASTARD.
1424 6255 2312 ISZ PT1
1425 6256 5252 JMP TEST
1426 6257 2313 ISZ PT2

```



```

1427 6260 5252 / JMP TEST
1430
1431 6261 1135 TAD H4
1432 6262 3313 DCA PT2
1433 6263 3312 DCA PT1
1434 6264 1134 TAD P240
1435 6265 6666 LCB!LPR
1436 6266 7200 CLA
1437 6267 6661 TESTC2, LSD
1440 6270 7410 SKP
1441 6271 5314 JMP LOKA2
1442 6272 2312 ISZ PT1
1443 6273 5267 JMP TESTC2
1444 6274 2313 ISZ PT2
1445 6275 5267 JMP TESTC2
1446
1447 6276 2212 / ISZ LOK1
1450 6277 2214 ISZ LOK1+2
1451 6300 2216 ISZ LOK1+4
1452 6301 2220 ISZ LOK1+6
1453 6302 3704 DCA I CCNOP
1454 6303 5212 JMP LOK1
1455
1456 6304 0747 CCNOP, CNOP
1457 /
1460 /
1461 /
1462 /
1463 /
1464 /
1465 /
1466 6305 0017 L17, 17
1467 6306 1576 PC1, M60
1470 6307 3662 PC2, M60A
1471 6310 7706 M72, -72
1472 6311 7624 M154, -154
1473 6312 0000 PT1, 0
1474 6313 0000 PT2, 0
1475 /
1476 /
1477 /
1500 /
1501 /
1502 /
1503 /
1504 6314 7305 LOKA2, CLL CLA IAC RAL
1505 6315 1153 TAD P212
1506 6316 6676 LCF!LPR
1507 6317 7200 CLA
1510 6320 1310 TAD M72
1511 6321 3706 DCA I PC1
1512 6322 1310 TAD M72
1513 6323 3707 DCA I PC2
1514 6324 1331 TAD PLP08C
1515 6325 3733 DCA I PXL1
1516 6326 1332 TAD PLP08E
1517 6327 3734 DCA I PXL2
1520 6330 5210 JMP LOK0
1521 /
1522 /
1523 6331 6071 PLP08C, LP08C
1524 6332 6073 PLP08E, LP08E
1525 6333 6040 PXL1, PCLP

```

/TIME HAS RUN OUT, CHANGE TO SET UT TTY MODE.

/ZAP OUT THE LPTEST ON THE BUFFERING ROUTINE

1526	6334	6037	PXL2, PCFIG	
1527	6335	1307	SYMFIX, TAD	LWDEFD&177*LOK
1530	6336	3504	SYMOVR, LWOE	
1531			/	
1532			/	
1533			/	
1534			/	
1535			/	
1536			/	
1537			/	
1540			/	
1541			/	
1542			/	
1543			/	
1544			/	
1545			/	
1546			TYBASE=2400	SOME BASIC DEFINITIONS FOR THE ROUTINES
1547			LLB=6654	/MAIN BASE FOR REFS.
1550			LCF=6652	
1551			LSD=6661	
1552			LCB=6662	
1553			LPR=6664	
1554			/	
1555			/	
1556			/	
1557			/	
1560			/	
1561			/	
1562			/	
1563			/	
1564			/	
1565			/	
1566			/	
1567			/	
1570			/	
1571				EJECT

```

1572 /
1573 /
1574 /
1575 / S Y M B O L   T A B L E   ! ! ! !
1576 /
1577 /
1600 /
1601 /
1602 /
1603 /
1604 /
1605 /
1606 /
1607 6400 7777 7777 *6400
1610 6401 7777 7777
1611 6402 7777 7777
1612 6403 7777 7777
1613 6404 7777 7777
1614 6405 7777 7777
1615 6406 7777 7777
1616 6407 7777 7777
1617 6410 7777 7777
1620 6411 7777 7777
1621 6412 7777 7777
1622 6413 7777 7777
1623 6414 5143 5143 /PSF
1624 6415 0336 0336
1625 6416 0000 0000
1626 6417 6021 6021
1627 6420 5123 5123 /PCF
1630 6421 0336 0336
1631 6422 0000 0000
1632 6423 6022 6022
1633 6424 5140 5140 /PPC
1634 6425 0157 0157
1635 6426 0000 0000
1636 6427 6024 6024
1637 6430 5134 5134 /PLS
1640 6431 1277 1277
1641 6432 0000 0000
1642 6433 6026 6026
1643 6434 5255 5255 /RCF
1644 6435 0336 0336
1645 6436 0000 0000
1646 6437 6011 6011
1647 6440 5254 5254 /RRB
1650 6441 0112 0112
1651 6442 0000 0000
1652 6443 6012 6012
1653 6444 5240 5240 /RFC
1654 6445 0157 0157
1655 6446 0000 0000
1656 6447 6014 6014
1657 6450 4170 4170 /CIF
1660 6451 0336 0336
1661 6452 0000 0000
1662 6453 6202 6202
1663 6454 4163 4163 /CDF
1664 6455 0336 0336
1665 6456 0000 0000
1666 6457 6201 6201
1667 6460 5243 5243 /RIB
1670 6461 0112 0112

```

1671	6462	0000	0000	
1672	6463	6234	6234	
1673	6464	5247	5247	/RMF
1674	6465	0336	0336	
1675	6466	0000	0000	
1676	6467	6244	6244	
1677	6470	5243	5243	/RIF
1700	6471	0336	0336	
1701	6472	0000	0000	
1702	6473	6224	6224	
1703	6474	5236	5236	/RDF
1704	6475	0336	0336	
1705	6476	0000	0000	
1706	6477	6214	6214	
1707	6500	5360	5360	/TLS
1710	6501	1277	1277	
1711	6502	0000	0000	
1712	6503	6046	6046	
1713	6504	5364	5364	/TPC
1714	6505	0157	0157	
1715	6506	0000	0000	
1716	6507	6044	6044	
1717	6510	5347	5347	/TCF
1720	6511	0336	0336	
1721	6512	0000	0000	
1722	6513	6042	6042	
1723	6514	5367	5367	/TSF
1724	6515	0336	0336	
1725	6516	0000	0000	
1726	6517	6041	6041	
1727	6520	4651	4651	/KRB
1730	6521	0112	0112	
1731	6522	0000	0000	
1732	6523	6036	6036	
1733	6524	4651	4651	/KRS
1734	6525	1277	1277	
1735	6526	0000	0000	
1736	6527	6034	6034	
1737	6530	4632	4632	/KCC
1740	6531	0157	0157	
1741	6532	0000	0000	
1742	6533	6032	6032	
1743	6534	4652	4652	/KSF
1744	6535	0336	0336	
1745	6536	0000	0000	
1746	6537	6031	6031	
1747	6540	4534	4534	/IOF
1750	6541	0336	0336	
1751	6542	0000	0000	
1752	6543	6002	6002	
1753	6544	4534	4534	/ION
1754	6545	1006	1006	
1755	6546	0000	0000	
1756	6547	6001	6001	
1757	6550	4705	4705	/LINC
1760	6551	1011	1011	
1761	6552	0000	0000	
1762	6553	6141	6141	
1763	6554	4173	4173/CLSK	
1764	6555	1312	1312	
1765	6556	0000	0	
1766	6557	6131	6131	
1767	6560	4173	4173/CLLR	

1770	6561	0716	716	
1771	6562	0000	0	
1772	6563	6132	6132	
1773	6564	4173	4173	
1774	6565	0047	47	
1775	6566	0000	0	
1776	6567	6133	6133	
1777	6570	4173	4173	
2000	6571	0307	307	
2001	6572	0000	0	
2002	6573	6134	6134	
2003	6574	4173	4173	/CLSA
2004	6575	1300	1300	
2005	6576	0000	0	
2006	6577	6135	6135	
2007	6600	4173	4173	/CLCA
2010	6601	0160	160	
2011	6602	0000	0	
2012	6603	6137	6137	
2013	6604	4173	4173	/CLBA
2014	6605	0113	113	
2015	6606	0000	0	
2016	6607	6136	6136	
2017	6610	4417	4417	/GLK
2020	6611	0627	0627	
2021	6612	0000	0000	
2022	6613	7204	7204	
2023	6614	5323	5323	/STL
2024	6615	0674	0674	
2025	6616	0000	0000	
2026	6617	7120	7120	
2027	6620	5323	5323	/STA
2030	6621	0045	0045	
2031	6622	0000	0000	
2032	6623	7240	7240	
2033	6624	4675	4675	/LAS
2034	6625	1277	1277	
2035	6626	0000	0000	
2036	6627	7604	7604	
2037	6630	4170	4170	/CIA
2040	6631	0045	0045	
2041	6632	0000	0000	
2042	6633	7041	7041	
2043	6634	4464	4464	/HLT
2044	6635	1344	1344	
2045	6636	0000	0000	
2046	6637	7402	7402	
2047	6640	5076	5076	/OSR
2050	6641	1232	1232	
2051	6642	0000	0000	
2052	6643	7404	7404	
2053	6644	5312	5312	/SKP
2054	6645	1120	1120	
2055	6646	0000	0000	
2056	6647	7410	7410	
2057	6650	5331	5331	/SZL
2060	6651	0674	0674	
2061	6652	0000	0000	
2062	6653	7430	7430	
2063	6654	5315	5315	/SNL
2064	6655	0674	0674	
2065	6656	0000	0000	
2066	6657	7420	7420	

2067	6660	5315	5315	/SNA
2070	6661	0045	0045	
2071	6662	0000	0000	
2072	6663	7450	7450	
2073	6664	5317	5317	/SPA
2074	6665	0045	0045	
2075	6666	0000	0000	
2076	6667	7510	7510	
2077	6670	5331	5331	/SZA
2100	6671	0045	0045	
2101	6672	0000	0000	
2102	6673	7440	7440	
2103	6674	5314	5314	/SMA
2104	6675	0045	0045	
2105	6676	0000	0000	
2106	6677	7500	7500	
2107	6700	4516	4516	/IAC
2110	6701	0157	0157	
2111	6702	0000	0000	
2112	6703	7001	7001	
2113	6704	5256	5256	/RTL
2114	6705	0674	0674	
2115	6706	0000	0000	
2116	6707	7006	7006	
2117	6710	5233	5233	/RAL
2120	6711	0674	0674	
2121	6712	0000	0000	
2122	6713	7004	7004	
2123	6714	5256	5256	/RTR
2124	6715	1232	1232	
2125	6716	0000	0000	
2126	6717	7012	7012	
2127	6720	5233	5233	/RAR
2130	6721	1232	1232	
2131	6722	0000	0000	
2132	6723	7010	7010	
2133	6724	4174	4174	/CML
2134	6725	0674	0674	
2135	6726	0000	0000	
2136	6727	7020	7020	
2137	6730	4174	4174	/CMA
2140	6731	0045	0045	
2141	6732	0000	0000	
2142	6733	7040	7040	
2143	6734	4173	4173	/CLL
2144	6735	0674	0674	
2145	6736	0000	0000	
2146	6737	7100	7100	
2147	6740	4173	4173	/CLA
2150	6741	0045	0045	
2151	6742	0000	0000	
2152	6743	7200	7200	
2153	6744	5025	5025	/NOP
2154	6745	1120	1120	
2155	6746	0000	0000	
2156	6747	7000	7000	
2157	6750	4577	4577	/JMP
2160	6751	1120	1120	
2161	6752	0000	0000	
2162	6753	5000	5000	
2163	6754	4577	4577	/JMS
2164	6755	1277	1277	
2165	6756	0000	0000	

2166	6757	4000	4000	
2167	6760	4227	4227	/DCA
2170	6761	0045	0045	
2171	6762	0000	0000	
2172	6763	3000	3000	
2173	6764	4540	4540	/ISZ
2174	6765	1702	1702	
2175	6766	0000	0000	
2176	6767	2000	2000	
2177	6770	5345	5345	/TAD
2200	6771	0224	0224	
2201	6772	0000	0000	
2202	6773	1000	1000	
2203	6774	4063	4063	/AND
2204	6775	0224	0224	
2205	6776	0000	0000	
2206	6777	0000	0	
2207				EJECT

	/LINC SYM TABLE			
	*7000			
2210				
2211				
2212			/	
2213			/	
2214	7000	5607	5607	/XOA
2215	7001	0045	0045	
2216	7002	0000	0000	
2217	7003	0021	0021	
2220	7004	5201	5201	/QLZ
2221	7005	1702	1702	
2222	7006	0000	0000	
2223	7007	0455	0455	
2224	7010	4352	4352	/FLO
2225	7011	1053	1053	
2226	7012	0000	0000	
2227	7013	0454	0454	
2230	7014	4652	4652	/KST
2231	7015	1344	1344	
2232	7016	0000	0000	
2233	7017	0415	0415	
2234	7020	5305	5305	/SFA
2235	7021	0045	45	
2236	7022	0000	0	
2237	7023	0024	24	
2240	7024	4075	4075	/AXO
2241	7025	1053	1053	
2242	7026	0000	0000	
2243	7027	0001	0001	
2244	7030	4314	4314	/ESF
2245	7031	0336	0336	
2246	7032	0000	0000	
2247	7033	0004	0004	
2250	7034	4464	4464	/HLT
2251	7035	1344	1344	
2252	7036	0000	0000	
2253	7037	0000	0000	
2254	7040	5166	5166	/QAC
2255	7041	0157	0157	
2256	7042	0000	0000	
2257	7043	0005	0005	
2260	7044	4173	4173	/CLR
2261	7045	1232	1232	
2262	7046	0000	0000	
2263	7047	0011	0011	
2264	7050	4071	4071	/ATR
2265	7051	1232	1232	
2266	7052	0000	0000	
2267	7053	0014	0014	
2270	7054	5256	5256	/RTA
2271	7055	0045	0045	
2272	7056	0000	0000	
2273	7057	0015	0015	
2274	7060	5025	5025	/NOP
2275	7061	1120	1120	
2276	7062	0000	0000	
2277	7063	0016	0016	
2300	7064	4176	4176	/COM
2301	7065	0741	0741	
2302	7066	0000	0000	
2303	7067	0017	0017	
2304	7070	5304	5304	/SET
2305	7071	1344	1344	
2306	7072	0000	0000	



2307	7073	0040	0040	
2310	7074	5300	5300	/S AM
2311	7075	0741	0741	
2312	7076	0000	0000	
2313	7077	0100	0100	
2314	7100	4235	4235	/D IS
2315	7101	1277	1277	
2316	7102	0000	0000	
2317	7103	0140	0140	
2320	7104	5613	5613	/X SK
2321	7105	0627	0627	
2322	7106	0000	0000	
2323	7107	0200	0200	
2324	7110	5251	5251	/R QL
2325	7111	0674	0674	
2326	7112	0000	0000	
2327	7113	0240	0240	
2330	7114	5251	5251	/R OR
2331	7115	1232	1232	
2332	7116	0000	0000	
2333	7117	0300	0300	
2334	7120	5302	5302	/S CR
2335	7121	1232	1232	
2336	7122	0000	0000	
2337	7123	0340	0340	
2340	7124	5327	5327	/S XL
2341	7125	0674	0674	
2342	7126	0000	0000	
2343	7127	0400	0400	
2344	7130	5315	5315	/S NS
2345	7131	1277	1277	
2346	7132	0000	0000	
2347	7133	0440	0440	
2350	7134	5312	5312	/S KP (L)
2351	7135	1120	1120	
2352	7136	0000	0000	
2353	7137	0456	0456	
2354	7140	4077	4077	/A ZE
2355	7141	0271	0271	
2356	7142	0000	0000	
2357	7143	0450	0450	
2360	7144	4065	4065	/A PO
2361	7145	1053	1053	
2362	7146	0000	0000	
2363	7147	0451	0451	
2364	7150	4726	4726	/L ZE
2365	7151	0271	0271	
2366	7152	0000	0000	
2367	7153	0452	0452	
2370	7154	4236	4236	/D JR
2371	7155	1232	1232	
2372	7156	0000	0000	
2373	7157	0006	0006	
2374	7160	4705	4705	/L IF
2375	7161	0336	0336	
2376	7162	0000	0000	
2377	7163	0600	0600	
2400	7164	4700	4700	/L DF
2401	7165	0336	0336	
2402	7166	0000	0000	
2403	7167	0640	0640	
2404	7170	5236	5236	/R DC
2405	7171	0157	0157	

2406	7172	0000	0000	
2407	7173	0700	0700	
2410	7174	5235	5235	/RCG
2411	7175	0403	0403	
2412	7176	0000	0000	
2413	7177	0701	0701	
2414	7200	5236	5236	/RDE
2415	7201	0271	0271	
2416	7202	0000	0000	
2417	7203	0702	0702	
2420	7204	4765	4765	/MTB
2421	7205	0112	0112	
2422	7206	0000	0000	
2423	7207	0703	0703	
2424	7210	5545	5545	/WRC
2425	7211	0157	0157	
2426	7212	0000	0000	
2427	7213	0704	0704	
2430	7214	5526	5526	/WCC
2431	7215	0403	0403	
2432	7216	0000	0000	
2433	7217	0705	0705	
2434	7220	5545	5545	/WRI
2435	7221	0515	0515	
2436	7222	0000	0000	
2437	7223	0706	0706	
2440	7224	4167	4167	/CHK
2441	7225	0627	0627	
2442	7226	0000	0000	
2443	7227	0707	0707	
2444	7230	5300	5300	/SAE
2445	7231	0271	0271	
2446	7232	0000	0000	
2447	7233	1440	1440	
2450	7234	5321	5321	/SRO
2451	7235	1053	1053	
2452	7236	0000	0000	
2453	7237	1500	1500	
2454	7240	4115	4115	/BCL
2455	7241	0674	0674	
2456	7242	0000	0000	
2457	7243	1540	1540	
2460	7244	4135	4135	/BSE
2461	7245	0271	0271	
2462	7246	0000	0000	
2463	7247	1600	1600	
2464	7250	4115	4115	/BCO
2465	7251	1053	1053	
2466	7252	0000	0000	
2467	7253	1640	1640	
2470	7254	4247	4247	/DSC
2471	7255	0157	0157	
2472	7256	0000	0000	
2473	7257	1740	1740	
2474	7260	4051	4051	/ADD
2475	7261	0224	0224	
2476	7262	0000	0000	
2477	7263	2000	2000	
2500	7264	5323	5323	/STC
2501	7265	0157	0157	
2502	7266	0000	0000	
2503	7267	4000	4000	
2504	7270	4577	4577	/JMP

2505	7271	1120	1120	
2506	7272	0000	0000	
2507	7273	6000	6000	
2510	7274	4764	4764	/MSC
2511	7275	0157	0157	
2512	7276	0000	0000	
2513	7277	0000	0000	
2514	7300	4700	4700	/LDA
2515	7301	0045	0045	
2516	7302	0000	0000	
2517	7303	1000	1000	
2520	7304	5323	5323	/STA
2521	7305	0045	0045	
2522	7306	0000	0000	
2523	7307	1040	1040	
2524	7310	4051	4051	/ADA
2525	7311	0045	0045	
2526	7312	0000	0000	
2527	7313	1100	1100	
2530	7314	4051	4051	/ADM
2531	7315	0741	0741	
2532	7316	0000	0000	
2533	7317	1140	1140	
2534	7320	4675	4675	/LAM
2535	7321	0741	0741	
2536	7322	0000	0000	
2537	7323	1200	1200	
2540	7324	4766	4766	/MUL
2541	7325	0674	0674	
2542	7326	0000	0000	
2543	7327	1240	1240	
2544	7330	4700	4700	/LDH
2545	7331	0450	0450	
2546	7332	0000	0000	
2547	7333	1300	1300	
2550	7334	5323	5323	/STH
2551	7335	0450	0450	
2552	7336	0000	0000	
2553	7337	1340	1340	
2554	7340	5307	5307	/SHD
2555	7341	0224	0224	
2556	7342	0000	0000	
2557	7343	1400	1400	
2560	7344	5345	5345	/TAC
2561	7345	0157	0157	
2562	7346	0000	0000	
2563	7347	0003	0003	
2564	7350	5361	5361	/TMA
2565	7351	0045	0045	
2566	7352	0000	0000	
2567	7353	0023	0023	
2570	7354	5124	5124	/PDP
2571	7355	1120	1120	
2572	7356	0000	0000	
2573	7357	0002	0002	
2574	7360	5323	5323	/STD
2575	7361	0224	0224	
2576	7362	0000	0000	
2577	7363	0416	0416	
2600	7364	4717	4717	/LSW
2601	7365	1523	1523	
2602	7366	0000	0000	
2603	7367	0517	0517	

2604	7370	5255	5255	/RSW
2605	7371	1523	1523	
2606	7372	0000	0000	
2607	7373	0516	0516	
2610	7374	4534	4534	/IOB
2611	7375	0112	0112	
2612	7376	0000	0000	
2613	7377	0500	0500	
2614				EJECT

-

/SPECIAL CHARACTERS AND PSEUDO-INSTRUCTIONS				
*7400				
2615				
2616				
2617				
2620	7400	6167	6167	/CHAIN
2621	7401	0056	0056	
2622	7402	1006	1006	
2623	7403	2536	XCHAIN	
2624	7404	6705	6705	/LISTAPE
2625	7405	1323	1323	
2626	7406	0065	0065	
2627	7407	5615	OUTPUT	
2630	7410	6303	6303	/EJECT
2631	7411	0274	0274	
2632	7412	1344	1344	
2633	7413	4261	PSUD05	/PSEUDO OP 5
2634	7414	6070	6070	/ASMIFZ (I HAD IT ASSIFZ ORGINALLY BUT THE PRUDES THOUGHT IT WAS TOO
2635	7415	0752	0752	/SUGGESTIVE! ! ! ! ! ! ! ! ! !)
2636	7416	0354	0354	
2637	7417	4265	PSUD01	/PSEUDO OP 1
2640	7420	6070	6070	/ASMIFN
2641	7421	0752	0752	
2642	7422	0370	0370	
2643	7423	4264	PSUD02	/PSEUDO OP 2
2644	7424	6070	6070	/ASMIFM
2645	7425	0752	0752	
2646	7426	0353	0353	
2647	7427	4263	PSUD03	/PSEUDO OP 3
2650	7430	6070	6070	/ASMSKP
2651	7431	0764	0764	
2652	7432	0647	0647	
2653	7433	4257	PSUD07	/PSEUDO OP 7
2654	7434	7300	7300	/SAVSYM
2655	7435	1501	1501	
2656	7436	1652	1652	
2657	7437	4260	PSUD06	/PSEUDO OP 6
2660	7440	6347	6347	/FIELD
2661	7441	0305	0305	
2662	7442	0224	0224	
2663	7443	2705	FLDUP	
2664	7444	7135	7135	/PMODE
2665	7445	1057	1057	
2666	7446	0271	0271	
2667	7447	3304	PDP8MD	
2670	7450	6711	6711	/LMODE
2671	7451	1057	1057	
2672	7452	0271	0271	
2673	7453	3303	LNKMOD	
2674	7454	7304	7304	/SEGMNT
2675	7455	0420	0420	
2676	7456	1032	1032	
2677	7457	0200	BANKCH	
2700	7460	6713	6713	/LODSYM
2701	7461	0247	0247	
2702	7462	1652	1652	
2703	7463	4262	PSUD04	/PSEUDO OP 4
2704	7464	0000	0000	/AND
2705	7465	0000	0000	
2706	7466	0062	0062	
2707	7467	3400	3400	
2710	7470	7056	7056	/OCTAL
2711	7471	1345	1345	
2712	7472	0674	0674	
2713	7473	2227	OCT	

2714	7474	6231	6231	/DECIMAL
2715	7475	0170	0170	
2716	7476	0742	0742	
2717	7477	2225	DECIM	
2720	7500	7351	7351	/TEXT
2721	7501	1614	1614	
2722	7502	0000	0	
2723	7503	1610	STRING	
2724	7504	7025	7025	/NOLIST
2725	7505	0705	0705	
2726	7506	1323	1323	
2727	7507	0555	PLIST	
2730	7510	6705	6705	/LIST
2731	7511	1323	1323	
2732	7512	0000	0000	
2733	7513	0554	DOLIST	
2734	7514	7121	7121	/PAGE
2735	7515	0410	0410	
2736	7516	0000	0	
2737	7517	0477	PAGEC	
2740	7520	0000	0000	/SEMICOLON
2741	7521	0000	0000	
2742	7522	0046	0046	
2743	7523	0200	0200	
2744	7524	0000	0000	/EXCLAMATION POINT
2745	7525	0000	0000	
2746	7526	0055	0055	
2747	7527	2200	2200	
2750	7530	6000	6000	/STAR
2751	7531	0000	0000	
2752	7532	0066	0066	
2753	7533	1345	ORGIC	
2754	7534	6000	6000	/POINT
2755	7535	0000	0	
2756	7536	0072	0072	
2757	7537	4142	PERIOD	
2760	7540	6000	6000	//
2761	7541	0000	0000	
2762	7542	0075	0075	
2763	7543	3570	THOU	
2764	7544	7411	7411	/U
2765	7545	0000	0000	
2766	7546	0000	0000	
2767	7547	1105	UN	
2770	7550	0000	0000	/COMMA
2771	7551	0000	0000	
2772	7552	0070	0070	
2773	7553	0600	0600	
2774	7554	0000	0000	/=
2775	7555	0000	0000	
2776	7556	0050	0050	
2777	7557	1400	1400	
3000	7560	7702	7702	/Z
3001	7561	0000	0	
3002	7562	0000	0	
3003	7563	1025	A+1	
3004	7564	6515	6515	/I
3005	7565	0000	0	
3006	7566	0000	0	
3007	7567	1066	H	
3010	7570	0000	0000	/-
3011	7571	0000	0000	
3012	7572	0071	0071	

3013	7573	5200	5200	
3014	7574	0000	0000	/*
3015	7575	0000	0000	
3016	7576	0067	0067	
3017	7577	4600	4600	
3020	7600	0000	0000	/SPACE
3021	7601	0000	0000	
3022	7602	0054	0054	
3023	7603	5600	5600	
3024				/
3025				/
3026				/
3027				/
3030				/
3031				/
3032				/
3033				/
3034				/
3035				/
3036				/
3037				EJECT

```

3040 /
3041 /
3042 /
3043 /
3044 /
3045 /
3046 FIELD 1 /THIS IS REALY IN 5000 OF FIELD 0.
3047 /
3050 /
3051 /
3052 /
3053 /
3054 /
3055 *5000
3056 /
3057 /
3060 /
3061 /
3062 /
3063 /
3064 /
3065 /
3066 5000 0000 XXXX, 0
3067 5001 1754 TAD I XBLOCK
3070 5002 0353 AND XL77
3071 5003 3366 DCA XTHISBLOCK
3072 5004 4312 JMS XRESET
3073 5005 7240 CLA CMA
3074 5006 4264 JMS XPUT
3075 5007 5205 JMP , -2
3076 5010 4312 JMS XRESET
3077 5011 4322 XLOOP1, JMS XGET
3100 5012 5334 JMP XCER
3101 5013 5225 JMP XOK1
3102 5014 1051 TAD ITEM
3103 5015 1350 TAD XM47
3104 5016 7650 SNA CLA
3105 5017 5211 JMP XLOOP1
3106 5020 1051 TAD ITEM
3107 5021 1346 TAD XM40
3110 5022 7650 SNA CLA
3111 5023 5211 JMP XLOOP1
3112 5024 5334 JMP XCER
3113 5025 4322 XOK1, JMS XGET
3114 5026 5334 JMP XCER
3115 5027 5334 JMP XCER
3116 5030 5234 JMP XINT01
3117 5031 4322 XLOOP2, JMS XGET
3120 5032 5334 JMP XCER
3121 5033 5244 JMP XDONE1
3122 5034 1051 XINT01, TAD ITEM
3123 5035 4765 JMS I XCON
3124 5036 3764 DCA I XXXP
3125 5037 2364 ISZ XXXP
3126 5040 1051 TAD ITEM
3127 5041 4264 JMS XPUT
3130 5042 5231 JMP XLOOP2
3131 5043 5334 JMP XCER
3132 /
3133 5044 7240 XDONE1, CLA CMA
3134 5045 4264 JMS XPUT
3135 5046 7000 NOP
3136 5047 4322 JMS XGET

```



3137	5050	5743	JMP I	XN
3140	5051	5334	JMP	XCER
3141	5092	3033	DCA	EVAL
3142	5053	3020	DCA	ANY
3143	5054	4477	JMS I	EXPR1
3144	5055	1020	TAD	ANY
3145	5056	7650	SNA	CLA
3146	5057	5743	JMP I	XN
3147	5060	1033	TAD	EVAL
3150	5061	0553	AND	XL77
3151	5062	3366	DCA	XTHISBLOCK
3152	5063	5743	JMP I	XN
3153			/	
3154			/	
3155			/	
3156			/	
3157			/	
3160			/	
3161	5064	0000	XPUT,	0
3162	5065	2017	ISZ	17
3163	5066	5272	JMP	,+4
3164	5067	7200	CLA	
3165	5070	2264	ISZ	XPUT
3166	5071	5664	JMP I	XPUT
3167	5072	0353	AND	XL77
3170	5073	3322	DCA	XGET
3171	5074	2355	ISZ	XHALF
3172	5075	5304	JMP	XRIGHT
3173	5076	1322	TAD	XGET
3174	5077	7106	CLL	RTL
3175	5100	7006	RTL	
3176	5101	7006	RTL	
3177	5102	3356	DCA	XT
3200	5103	5664	JMP I	XPUT
3201			/	
3202	5104	7240	XRIGHT,	CLA CMA
3203	5105	3355	DCA	XHALF
3204	5106	1356	TAD	XT
3205	5107	1322	TAD	XGET
3206	5110	3416	DCA I	16
3207	5111	5664	JMP I	XPUT
3210			/	
3211			/	
3212			/	
3213			/	
3214	5112	0000	XRESET,	0
3215	5113	7240	CLA	CMA
3216	5114	3355	DCA	XHALF
3217	5115	1347	TAD	XM9
3220	5116	3017	DCA	17
3221	5117	1357	TAD	XP
3222	5120	3016	DCA	16
3223	5121	5712	JMP I	XRESET
3224			/	
3225			/	
3226			/	
3227	5122	0000	XGET,	0
3230	5123	4751	JMS I	XGETIN
3231	5124	1352	TAD	XM43
3232	5125	7450	SNA	
3233	5126	5722	JMP I	XGET
3234	5127	2322	ISZ	XGET
3235	5130	7001	IAC	

3236	5151	7640		SZA	CLA	
3237	5132	2322		ISZ		XGET
3240	5133	5722		JMP	I	XGET
3241			/			
3242			/			
3243			/			
3244			/			
3245			/			
3246			/			
3247	5134	1344	XCER,	TAD		XL6
3250	5135	4476		JMS	I	ERR1
3251	5136	4465		JMS	I	PASSEK
3252	5137	4466		JMS	I	CURSKA
3253	5140	4532		JMS	I	SCLEAR
3254	5141	4530		JMS	I	LINENO
3255	5142	5517		JMP	I	MON
3256			/			
3257	5143	5202	XN,			XXN
3260	5144	0006	XL6,			6
3261	5145	0017	XL17,			17
3262	5146	7740	XM40,			-40
3263	5147	7767	XM9,			-9
3264	5150	7731	XM47,			-47
3265	5151	3670	XGETIN,			GETIN
3266	5152	7735	XM43,			-43
3267	5153	0077	XL77,			77
3270	5154	4175	XBBLOCK,			BBLOCK
3271	5155	0000	XHALF,			0
3272	5156	0000	XT,			0
3273	5157	5157	XP,			,
3274	5160	0000	XXN1,			0
3275	5161	0000	XXN2,			0
3276	5162	0000	XXN3,			0
3277	5163	0000	XXN4,			0
3300	5164	5310	XXXP,			XNM1
3301	5165	3600	XCON,			CONVRT
3302			/			
3303			/			
3304			/			
3305			/			
3306			/			
3307	5166	7777	XTHISBLOCK,			-1
3310	5167	0036				36
3311	5170	0346				346
3312	5171	0002				2
3313			/			
3314			/			
3315			/			
3316			/			
3317			/			
3320			/			
3321			/			
3322	5172	5600	XXRET,		JMP I	XXXX
3323			/			
3324			/			
3325			/			
3326			/			
3327			/			
3330			/			
3331			/			
3332			/			
3333			/			
3334			/			

PAGE

3335		/			
3336		/			
3337		/			
3340	5200	4754	XX XR,	JMS I	XXGET
3341	5201	7410		SKP	
3342	5202	1051	XXN,	TAD	ITEM
3343	5203	1341		TAD	XXM43
3344	5204	7640		SZA	CLA
3345	5205	5200		JMP	XXXR
3346			/		
3347	5206	4736		JMS I	XREAD
3350	5207	5166		XTMISBLOCK	
3351	5210	1337		TAD	XL6777
3352	5211	3016		DCA	16
3353	5212	1340		TAD	XM100
3354	5213	3202		DCA	XXN
3355	5214	1016	XXLOOP,	TAD	16
3356	5215	7040		CMA	
3357	5216	0342		AND	XL7770
3360	5217	7040		CMA	
3361	5220	3016		DCA	16
3362	5221	1443		TAD	XXP
3363	5222	3017		DCA	17
3364	5223	1344		TAD	XM4
3365	5224	3203		DCA	XXN+1
3366	5225	6211	XXLP,	CDF	10
3367	5226	1416		TAD I	16
3370	5227	6201		CDF	0
3371	5230	7041		CIA	
3372	5231	1417		TAD I	17
3373	5232	7640		SZA	CLA
3374	5233	5327		JMP	XXY
3375	5234	2203		ISE	XXN+1
3376	5235	5225		JMP	XXLP
3377	5236	6211		CDF	10
3400	5237	1416		TAD I	16
3401	5240	3204		DCA	XXN+2
3402	5241	1416		TAD I	16
3403	5242	6201		CDF	0
3404	5243	7710		SPA	CLA
3405	5244	5327		JMP	XXY
3406	5245	4465		JMS I	PASSEK
3407	5246	4466		JMS I	CURSKA
3410	5247	4532		JMS I	SCLEAR
3411	5250	4530		JMS I	LINENO
3412	5251	1204		TAD	XXN+2
3413	5252	3745		DCA I	XXL
3414	5253	1346		TAD	XL7400
3415	5254	3750		DCA I	XX1
3416	5255	3751		DCA I	XX2
3417	5256	1347		TAD	XL4400
3420	5257	3752		DCA I	XX3
3421	5260	3037		DCA	MODE
3422	5261	1733		TAD I	XTH
3423	5262	3734		DCA I	XHT
3424	5263	4736		JMS I	XREAD
3425	5264	4170		LTAB	
3426	5265	4465		JMS I	PASSEK
3427	5266	5321		JMP	XXFH
3430	5267	1335		TAD	XM26
3431	5270	4475		JMS I	SKIP
3432	5271	1277	XXT,	TAD	XXMESS
3433	5272	7450		SNA	

3434	5273	5321		JMP	XXFH
3435	5274	4401		JMS I	DECOUT
3436	5275	2271		ISZ	XXT
3437	5276	5271		JMP	XXT
3440			/		
3441			/		
3442	5277	0303	XXMESS,	303	
3443	5300	0310		310	
3444	5301	0301		301	
3445	5302	0311		311	
3446	5303	0316		316	
3447	5304	0311		311	
3450	5305	0316		316	
3451	5306	0307		307	
3452			/		
3453	5307	0240		240	
3454			/		
3455	5310	0000	XNM1,	0	
3456	5311	0000		0	
3457	5312	0000		0	
3460	5313	0000		0	
3461	5314	0000		0	
3462	5315	0000		0	
3463	5316	0000		0	
3464	5317	0000		0	
3465	5320	0000		0	
3466			/		
3467			/		
3470	5321	4500	XXFH,	JMS I	TYCARI
3471	5322	7240		CLA CMA	
3472	5323	3012		OCA	CURLIN
3473	5324	4753		JMS I	XBUF IN
3474	5325	5726		JMP I	,+1
3475	5326	5172		XXRET	
3476			/		
3477			/		
3500			/		
3501			/		
3502			/		
3503			/		
3504			/		
3505	5327	2202	XXY,	ISZ	XXN
3506	5330	5214		JMP	XXLOOP
3507	5331	5732		JMP I	,+1
3510	5332	5134		XCER	
3511			/		
3512			/		
3513			/		
3514			/		
3515			/		
3516			/		
3517			/		
3520			/		
3521			/		
3522			/		
3523	5333	5166	XTH,	XTHISBLOCK	
3524	5334	4175	XHT,	BBLOCK	
3525	5335	7752	XN26,	-26	
3526	5336	7774	XREAD,	READ	
3527	5337	6777	XL6777,	6777	
3530	5340	7700	XM100,	-100	
3531	5341	7735	XXM43,	-43	
3532	5342	7770	XL7770,	7770	

3533	5343	5157	XXP,	XP
3534	5344	7774	XM4,	-4
3535	5345	4177	XXL,	BUFINZ
3536	5346	7400	XL 7400,	7400
3537	5347	4400	XL 4400,	4400
3540	5350	3354	XX1,	CHRC
3541	5351	3351	XX2,	WDHALF
3542	5352	3352	XX3,	PTBUFP
3543	5353	4006	XBUFIN,	BUFIN
3544	5354	3670	XXGET,	GETIN
3545			/	
3546			/	
3547			/	
3550			/	
3551			/	
3552			/	
3553			/	
3554			/	
3555			/	
3556			/	
3557			/	
3560			/	
3561			/	
3562			/	
3563			/	
3564				EJECT

M A J O R T A P E D E F I N I T I O N S

3565 /  
3566 /  
3567 /  
3570 /  
3571 /  
3572 FUDGE1=326-300  
3573 FUDGE2=467-370  
3574 SCRATCH=325-300 /DEFINES A SCRATCH AREA FOR SAVSYM&LODSYM  
3575 BCHAIN=324-300  
3576 BOOUT=450-370  
3577 /  
3600 /  
3601 /  
3602 /  
3603 /  
3604 DIALUNIT=100  
3605 DIALBINARY=111  
3606 /  
3607 /  
3610 /  
3611 /  
3612 READ=7774  
3613 WRITE=7775  
3614 /  
3615 /  
3616 /  
3617 /  
3620 /  
3621 /  
3622 /  
3623 /  
3624 /  
3625 EJECT

3626  
3627  
3630  
3631  
3632  
3633  
3634  
3635  
3636  
3637  
3640  
-

/  
/  
/  
/  
/  
/  
/  
/  
/  
/  
/  
/  
/  
/  
/

END ASSEMBLY!!!!!!!!!!

EJECT

3641  
3642  
3643  
3644  
3645

/  
/  
/  
/



NO ERRORS

SYMBOL	VALUE	DEF	REFERENCES
A	1024	1515	1521 1545 1565 3003
AAOR	0030	0331	0517 0522 0525 0553 0563 1025 1030 1032 2051 2061 2071 0115 0121 0177 0227 1022 1534 1557 1602 1613 1621 1624 2430 2755 2764 2770 2776
AAORL	3052	1603	1623 1626
AALPHA	4004	2602	2671
AAS	1332	2030	2041 1717
ABANK	0046	0347	2070 0205 1616 2432 2773
ABNOP1	3042	1573	0067
ABNOP2	3043	1574	0070
ABNOP3	3044	1575	0071
ABNOP4	3045	1576	0072
ACHECK	5460	0357	0424
ACOUNT	5400	0250	0340 0345 0346 0366
ADDCON	4254	3120	3103
ADR	0165	0467	1002 1733
AJECT	5516	0434	0310
AEPONT	5532	0452	0445
AEP62	5531	0451	0441
AFORT	5457	0356	0411
ALL	7600	1467	1527
ALPHA	2400	1116	1215 2602
ALPHAB	3445	2153	2133
AMAINP	5507	0421	0353
AMM10	5505	0417	0323
ANDS	3400	1463	1526
ANLXC	0054	1240	1213 1261
ANLXE	0057	1244	1212
ANY	0020	0321	0513 0714 1021 0077 0103 0706 1106 1111 1505 2760 0261 3142 3144
ANYY	2367	1102	0704 1112
APAEND	5477	0376	0420
APAGE	0031	0332	1725 2055 0201 0231
ASEND	5506	0420	0351
ASPAST	5467	0366	0363
ASSNO	5503	0411	0263 0331 0337 0437 0443 0446 0465 0564 1002
ASSRST	5471	0370	0401
ASSYIN	5441	0340	0333
AWAY	1241	1737	1723 1727
AW	1313	2011	2027 2031 2033 2035
B	1076	1567	1517 1520
BAO	6400	1326	1371 1372 1275
BAND0	5031	0074	0115
BANKCH	0200	0512	2677
BANKEM	0220	0532	0515
BANKHR	0211	0523	0540
BANOP1	5024	0067	0106
BANOP2	5025	0070	0110
BANOP3	5026	0071	0112
BANOP4	5027	0072	0114
BANOP5	5030	0073	0116
BBLOCK	4175	3021	2606 2617 3270 3524
BCHAIN	0024	3575	1315
BEGNAS	5002	0045	
BEGNLI	5000	0043	
BINBLK	0011	0311	1553 2363 2423 2647 3212
BINCK	3020	1551	1545
BINHDR	4164	3004	2664
BINPTR	0010	0310	1542 1546 1550 1551 2420 2422 2621
BINTAB	0176	0500	1541
BIT	2047	0554	2456
BITT	3712	2456	2455
BIT6	3400	2102	0366 2113 2126 2141 2150 2152 2155

SYMBOL	VALUE	DEF	REFERENCES
BIT6A	0064	0366	0554
BIT6M3	3462	2170	2134
BLKUSE	4340	3301	3222
BLM10	5035	0100	0123
BLPM22	5036	0101	0124
BLTAD	5032	0075	0117 0121
BLTAD1	5033	0076	0120
BLTAD2	5034	0077	0122
BOOUT	0060	3576	0604
BUFI	3350	2027	2014
BUFIN	4006	2604	2027 2610 2630 3543
BUFINZ	4177	3023	2607 2615 3535
BUMP	0726	1323	1270 1312 1324 1325 1331 1332 1333 1334
B1	1041	1532	0755 1542 1543
B11	0434	0755	0734 0744
B2	1046	1537	0405 1550 1574
B21	0103	0405	1111 0733 0735 1774 2767
C	1055	1546	1522 1523 1524 1526 1540 1552 1554 1556 2325
CARET	3443	2151	2124
CCDF	0753	1355	1353
CCNOP	6304	1456	1453
CHARAC	0057	0360	0147 0567 0573 0616 0633 0640
CHARX	0044	0345	0722 1773 2007 0555 0556
CHARX2	0045	0346	0737 0557 0711 0720
CHECK	0740	1342	0443 1171 1345 1347 1351 1361
CHECKO	5737	1032	2646 1047
CHEKER	0070	0372	1243
CHKL	1264	1762	1750
CHKLA	1222	1720	1710
CHO	4045	2643	2624
CHRC	3354	2033	2006 2011 2643 3540
CJMP1	1547	0224	0375 0062 0222
CKUN	3262	1740	1731 1744
CLEARR	2132	0637	0434 0127 0650
CLEUP	1453	0127	0071
CNOP	0747	1351	1456
CNTLP1	0004	0302	0070 1244 1404 2725
CNTMON	2363	1075	1072
CNTRLP	2353	1064	0302 1066 1073
COMMA	0600	1456	1541
COMMAN	0260	0574	0544 0254
COMMEN	3701	2445	0540 2452
COMS	2036	0540	0546
CON	0164	0466	1472 1474 1606 1627 1711 0265 0270 0271 2323 2462 2463 3054 3063 3064 3102 3110 3111
CONREC	3725	2502	2453
CONSKP	3674	2440	2446 2454
CONVRT	3600	2340	0662 2346 3301
CONYES	3700	2444	2445 0073
COSA	3541	2270	2255
COUNT	0760	1370	1167 1264 1265 1304 1314 1343 2746 1272
CRFOUN	0010	1151	1143
CRIOR	1165	1660	1505 1546 1551 1553 1555 1603 1636 1644
CTYPO	0763	1373	1357
CURLIN	0012	0312	0406 0414 0425 0433 1247 1573 1665 2635 3472
CURR	0043	0344	0771 0774 0775 1002 1010 1015
CURREN	0227	0542	1667
CURSKA	0066	0370	0530 1035 1655 2064 0173 0341 1511 3252 3407
CURSKP	2520	1246	0370 1254
C1A	3576	2325	2324
DECIM	2225	0732	2717
DECIMS	2231	0736	0732 0741
DECOUT	0001	0277	1407 0657 1240 1242 1451 1471 1674 1703 2211 2262 2264 2721 2723 2724 0657 1042 3435

SYMBOL	VALUE	DEF	REFERENCES
DEFIN1	1174	1667	1600
DIALBI	0111	3605	3004 3176 0520 0602
DIALUN	0100	3604	1313 1321 2060 3011 3243 0207
DISRE	4001	2576	2665
DISRET	3463	2171	2216 2576
DLFT	2126	0633	0673
DOCAL	1426	0102	0252 0425
DOLEFT	1474	0151	0143
DOLIST	0554	1076	2733
DOPOUT	0567	1111	1103
DPCS	2212	0717	0714 0731
DPCV	2200	0705	0736 0723 0726
DPCVM2	2242	0747	0715
DPCVOP	0415	0736	0733
DRHT	2111	0616	0674
DV3	2640	1433	1430
D6	0300	0246	1775 3013
D7	0370	0247	0310 0500 2600 2637 3006 3222
D8	0410	0250	
D9	0446	0251	
EDEFIN	3771	2561	2556
EMLEVE	2130	0635	0571 0620
EMPTRA	0172	0474	0576 0600 0601 0622
EMPTY	2054	0561	0363 0566 0636
EMPTY1	0061	0363	0110 1253
ENDMS	3717	2471	0700 0427
ENTS	2000	0501	0525 0531 0533 1745 0075
ENTS1	3267	1745	1733
EQCHK	2332	1043	1032 1050
EQCHKI	2340	1051	1045
EQRETI	0006	0304	1637 1643 1047 2046
EQU	1142	1635	1572
EQUALS	1400	1460	1544 1572
EGUCHK	3366	2045	1051 2050
EQUERR	3766	2555	1633
ERONE	1140	1632	1544
ERRCNT	0167	0471	0167 0210 0642 0645 1570 1662 1706
ERROR	3201	1656	0400 0400 1713
ERR1	0076	0400	0757 1671 1026 1037 1100 2047 2157 2555 3250
ERR12	2364	1077	1057
ERR2	2275	1006	0576 1012 1024 1027 1053 1060
ERSY	0674	1245	1156
ERTOT	0002	0300	0206 0643 0644 2173
EVAL	0033	0334	0526 0533 0535 1033 1037 1607 1646 1720 1741 1751 1754 1755 1767 2050 2052 2062 2066 0106 0113 0203 0305 0316
EXCLAM	2200	1462	1524
EXPR	1000	1471	0401 1512 1605 1630
EXPR1	0077	0401	0512 1020 1641 1702 2044 0102 1501 0260 0434 3143
E7	0000	0245	
FACTOR	4330	3222	3213
FDRT	2714	1510	0377 1504 1515 1521 1524 0356
FIELDM	2717	1513	1507
FINEND	2173	0700	0553 0426
FIRST	6110	1325	1271 1313 1371 1274 1275
FLDUP	2705	1501	2663
FLDWD	0036	0337	0534 0207 1523 1543
FOUND	2507	1231	1120 1205 1213 1221
FSBLK	4002	2600	2613 0147 0152
FSUNIT	4003	2601	2616 0145
FUDGE1	0026	3572	0211
FUDGE2	0077	3573	0522
G	1113	1604	1525 1527

SYMBOL	VALUE	DEF	REFERENCES
GENINI	1703	0401	0275 0330 0370
GET	1110	1601	1541 1573
GETADR	1200	1676	1665 1700 1735 1736
GETAD1	1172	1665	1601
GETASY	3242	1720	0412 1723 1726 1736 1737 1743
GETAS1	0110	0412	0762
GETCHR	0067	0371	2435
GETIN	3670	2434	0401 0537 2443 2447 3265 3544
GETLET	0441	0762	0727
GETS	2035	0537	0543
GETSYM	0400	0721	0411 0761 0767 0772 0776 1003 1011
GETSY1	0107	0411	1016 1516 1537 1571
GETVAL	5401	0251	0265 0327 0334 0461 1001
GETYE	0365	0703	0675
GETYPE	3623	2367	0703 2316 2416
GGGET	0676	1262	1273 1356
GSTART	0446	0767	0753 1004 1017
GTYPOT	0464	1005	1001
GYP	3567	2316	2302
H	1066	1557	1577 3007
HIC	0052	0353	0707 1422 1431 1435
H6	1075	1566	1507 1511 1563 1564 1610 1613
IDX	2037	0542	0406 0560 2161
IDX1	0104	0406	0760 1515 1536 1640 1677 2004 2043 0072 0717 2766 0364
IMINIT	5132	0203	0172
IMMOVE	5130	0201	0156
IMREAD	5131	0202	0164
IMTYPO	5127	0200	0171
IM215	5126	0177	0170
IN	0050	0351	2003 1722 1724
INAS	0073	0375	0125
IND	0166	0470	1611 1744 1753 1770 0100
IND1	0370	0706	0622 0630 0636
IND1B	0364	0702	0674
IND1C	0366	0704	0677
INIT	4013	2611	0361 2636 0203
INIT1	0060	0361	0221 0167
INP	0722	1313	1311 2744
INST	0055	0356	0650 1475 1477 1622 1625 0236
INSYM	3375	2062	1767
ITABIN	5133	0207	0165
ITEM	0051	0352	0135 0141 0311 0321 0335 0347 0364 0547 2103 2130 2137 2154 2436 2442 0341 0360 3102 3106 3122 3126 3342
JBHSTR	1707	0406	0413 1356
JBNOF	5014	0057	0105 0107 0111 0113
JBSMF	1732	0433	0412
JBTEST	1706	0405	0432 0422 0430
JEND	1734	0435	1113 0423 0062
JJEND	0571	1113	1110
JJSTAR	0570	1112	1105
JNOP	1730	0427	0102
JSTART	1733	0434	1112 0420 0063
JUDGE	2452	1170	1152 1162
KILBUF	4075	2701	1075
KLOOP	4114	2725	2704 2731
KLUG2	2170	0675	0667
LBAD	6103	1275	1227
LCB	6662	1552	1260 1266 1420 1435
LCF	6652	1550	1240 1250 1344 1417 1506
LCOUNT	6100	1272	1220
LDT	1274	1772	1775 2006 2010 2012 2025 2037
LEAVE	1236	1734	1732 1745 1756
LEFTHF	3340	2017	2001

SYMBOL	VALUE	DEF	REFERENCES
LEVEL	1256	1754	1717 1766 1771
LFF	6032	1174	1161
LFF2	6033	1175	1165
LFIRST	6102	1274	1224
LFTEST	6014	1195	1202
LINENO	0130	0432	0065 0345 3254 3411
LINKDT	4152	2770	2763
LINKI	1104	1575	1561
LINKIC	1370	2066	2047
LINKB	2624	1417	1400
LINKBA	3551	2300	1417 2307 2315
LISREG	5062	0125	0104
LISTA	2731	1525	0234
LISTWD	0003	0301	0132 0164 0411 0427 0562 1565 2035 2501 0046 0053
LIST1	1557	0234	0075
LLB	6654	1547	1240
LNCK	3737	2517	0653 2523
LNCKA	2146	0653	0621 0651
LNINST	1560	0235	0702 0251
LNKA	3062	1613	1601
LNKAOD	4250	3113	3106
LNKMOD	3303	1762	2673
LNKOR	1250	1746	1705
LNKREG	1452	0126	0120
LNKSUB	4225	3066	3060
LNRT	1365	2063	2057 2072
LOK	6200	1343	1400 1403 1406 1410 1423 1527
LOKA2	6314	1504	1441
LOK0	6210	1354	1520
LOK1	6212	1357	1447 1450 1451 1452 1454
LOUTP	6101	1273	1222 1223 1225 1230 1231
LOWTMP	0140	0442	1267 1272 1562 1564
LPBACK	6041	1220	1146
LPR	6664	1553	2733 1251 1260 1266 1345 1435 1506
LPRENT	6065	1252	1267
LPTEST	6244	1413	0137
LP00C	6071	1260	1523
LP00E	6073	1263	1524
LSD	6661	1551	1350 1145 1421 1437
LSRTE	1472	0147	0157
LSTSYM	1454	0131	0373 0134 0140 0150
LTAB	4170	3011	2633 3425
LTREAD	4005	2603	2605 2632
LWC	0053	0354	1533 0710 0752 0770 0772 0777 1001 1421 1423 1434 1437 2320
LWD	3477	2206	2175 2203 2204 2212
LWDE	3504	2214	2210 1530
LWDEFD	3507	2224	1527
L10	6104	1300	1247
L17	6305	1466	1343
L7710	5520	0436	0325
L777	4174	3017	2614
MAIN	1400	0054	0374 0063
MAINEX	0072	0374	2474 0126 0166
MAINSA	1904	0161	0105 0421 0422
MAINSE	1411	0065	0403 0111 0163 0166 0174
MAINSF	1416	0072	0600 2561
MAIN1	0101	0403	0531 1036 1656 2065 1303 1512
MAIN1A	0264	0600	0572
MASSIF	5426	0325	0306
MESS	3510	2232	2206
MESSS	3520	2242	2200
MICRO	0056	0357	1623 1706

SYMBOL	VALUE	DEF	REFERENCES
MICROB	0005	0303	1617 1746
MICROL	0054	0355	1500 1502 1616 1621 0246
MINUS	5200	1465	1523
MMHOVE	4136	2751	2712
MODE	0037	0340	0550 0672 1557 1703 2045 0060 0116 1502 1577 1764 1765 2631 2761 3056 3104 3421
MON	0117	0421	1672 0356 1101 2673 3255
MONIT	4101	2712	0421
MOVA	0545	1066	1056
MOVB	0540	1061	1074
MOVEAA	0262	0576	0547
MOVE1	0074	0376	1176
MOVE8	0524	1045	0376 1051 1053 1054 1055 1065 1100 1104 1106
MTAD	2265	0775	0757 0763 1002
MTDG	2273	1004	0727 0761
MTHREE	7346	0256	0656
MTRL	2257	0766	0755 0756 0760 0773
MTSW	2251	0757	0737 0740 0744
MTWO	7344	0254	1234 0520 1516 1604 1610 1667 1704 2413
MT10	2243	0751	0730 0764
M1	0523	1044	1046
M1A	1735	0436	
M10	2171	0676	0664
M1000	0121	0423	0216 0743
M12A	0414	0735	0730
M140	6060	1245	
M154	6311	1472	1347
M20	3454	2162	2107
M212	6105	1301	1157
M215	0151	0453	1070 1141 1163 1203
M22	2535	1263	1251 0101
M26	3661	2425	2355
M33	0123	0425	0725 1445 2131
M4	0135	0437	1043 1457 2256 1414 1431
M40	0013	0313	2104 2342 2653 0324
M43	0122	0424	0136 0334 0365 2450 0342 0361
M45	0125	0427	2000 0721 1426
M47	0133	0435	0612 0627
M57	2034	0536	0544
M6	3101	1632	1575
M6A	1261	1757	1715
M60	1576	0253	0073 0403 1467
M60A	3662	2426	0441 2357 1470
M67	0126	0430	0712
M7	2702	1476	1376
M7TWO	2174	0701	0075
M72	6310	1471	1510 1512
M77	3756	2537	2505
NASS IF	5424	0323	0304 0504
NONER	3046	1577	1572
NOS	4137	2755	2775
NOTAB1	2107	0614	0076
NOTAB2	2124	0631	0077
NOTBLK	3616	2362	1627 2366
NOTBL1	3076	1627	1555
NOTLDT	1311	2007	2002
NUM	6106	1313	1153 1171 1174 1253
NUPAGE	1262	1760	1731 1776 1777 2005 2013 2014 2023
NXCAND	2413	1131	1211
OASSNO	5725	1002	0624 0655 0660 0744
OBIN	5720	0756	0735
OBLOCK	5735	1013	0632 0722
OBSET	5706	0733	0627 0736

SYMBOL	VALUE	DEF	REFERENCES
OCCRLF	5751	1046	1035 1041
OCDOIT	5743	1037	1043 1044
OCHECK	4050	2646	2666
OCPNT	5753	1054	1037
OCT	2227	0734	2713
OCTS	2235	0742	0212 0734 0745
OCTS1	1535	0212	0064 0217
OCUSES	5776	1102	1033
OEND	5661	0673	0667 0700
OGTVAL	5724	1001	0620
OLOC	5730	1005	0634 0674 0706 0707 0713 0714
OL17	5726	1003	0630
OL377	5732	1007	0675 0711 0715
OL6400	5731	1006	0633 0712
ONEREG	1436	0112	0107 0124 0126 0402
ONEREI	1704	0402	0306 0361
ONVRT	2155	0662	0656
OOPUT	5667	0705	0670 0673 0717 0723
OPOINT	5727	1004	0656
OPS	2661	1455	0364 1402 1473 1474 1531
OPUT	5654	0665	0621 0625 0671 0677 1004
OP1	4273	3150	3134 3135 3136 3137 3140 3141 3143 3146
ORGIC	1345	2043	2753
OSANDV	2600	1373	1230 1405
OSYM	2613	1406	1374 1416 1425 1444 1456 1461 1464 1465
OUNIT	5733	1011	0631 0721
OUTP	0705	1271	1266 2745 1273
OUTPUT	5615	0620	2627
OUTTAB	2156	0663	0614 0631
OUTTP	2147	0654	0615 0632 0661
OX	2625	1420	1411 1413 1415 1441
OXREAD	2546	1310	1276 1301
OXWRIT	2547	1311	1274
PACHEC	5512	0424	0347
PAFTER	4270	3145	0277
PAGEC	0477	1020	2737
PAGEM	0516	1037	1023
PAGE1	0102	0404	0524 1031 2060 0125 1773
PAGHER	0510	1031	1043
PAGSET	3524	2253	0372 2267 2274 2277
PASS	0035	0336	1101 0057 0161 0215 0564 1031 1035 1041 2040 2437 2471 0462 0502 0622
PASSEK	0065	0367	0527 1034 1694 2063 0172 0307 0340 0362 1510 1661 1710 0435 3251 3406 3426
PASSER	3355	2034	0367 2042 2043 2044
PASS1	1401	0055	0054 0224
PASS1P	1407	0063	0223
PASS2	1537	0214	0225
PCFIG	6037	1212	1172 1526
PCHECK	0141	0443	1303 1315 2726
PCLP	6040	1213	1147 1525
PCONT	3522	2251	2214 2215 2254 2270 2276 2513 0452
PCOT	3736	2513	2504
PCOUNT	4133	2746	2701 2727
PC1	6306	1467	1350 1351 1511
PC2	6307	1470	1352 1513
PDLK	4147	2765	2757 3000
PDOCAL	5513	0425	0370
PDOLLA	5514	0426	0352 0373
PDPBER	0253	0566	0562
PDPBMD	3304	1763	2667
PENDMS	5515	0427	0372 0377
PERIOD	4142	2760	2757
PERMA	0032	0333	0644 0055 1121 2550



SYMBOL	VALUE	DEF	REFERENCES
PGJS	3723	2500	2503 2512 2674
PINP	4131	2744	2702
PJEND	5017	0062	0052
PJMP	5414	0303	0300
PJNOP	5037	0102	0060 0061
PJSTAR	5020	0063	0050
PLIST	0555	1077	2727
PLQVR	0762	1372	1326
PLP08C	6331	1523	1514
PLP08E	6332	1524	1516
PLTST	0761	1371	1305 1330
PLUS	4600	1464	1522
PL17	4130	2741	2732
PL212	4135	2750	2722
PL215	4134	2747	2720
PMAINS	5510	0422	0354 0367 0374 0400
PM60A	0137	0441	0440
POINT	0047	0350	0076 1055 1061 1062 3171 3172 3173
POPUP1	4307	3167	0410 3174
POPUP1	0106	0410	1604 1612 1614 1620 1624 1626 1734
POSAND	2506	1230	1223
POUTP	4132	2745	2703
PPSEUD	4274	3152	3144
PRINT	0107	1314	
PRINT	0000	1140	1152 1154 1167 1175 1232 1242 1255 1404
PRSYMB	2474	1213	1135
PR1	6226	1373	1360
PR2	6227	1374	1362
PR3	6230	1375	1364
PR4	6231	1376	1366
PR5	6232	1377	1370
PSEUDO	5410	0277	3152 0375 0412
PSINTE	1575	0252	0101 0423
PSRET	4201	3151	3145 3147
PSTCHK	0261	0575	0546
PSTS	4074	2674	2672
PSUD	0334	0652	0643
PSUD01	4265	3142	2637
PSUD02	4264	3141	2643
PSUD03	4263	3140	2647
PSUD04	4262	3137	2703
PSUD05	4261	3136	2633
PSUD06	4260	3135	2657
PSUD07	4257	3134	2653
PSWITC	5511	0423	0350 0371
PTB	4047	2645	2627
PTBUFF	3353	2032	2012
PTBUFP	3352	2031	2002 2005 2013 2021 2645 3542
PTHREE	7325	0252	0756 1164 2156
PTOCHC	1577	0254	0067
PT1	6312	1473	1416 1424 1433 1442
PT2	6313	1474	1415 1426 1432 1444
PUNONE	3001	1532	0422 0213 1533 1567 1574 1603 1607 1612
PUNON1	0120	0422	0114
PUSH1	0105	0407	1473 1476 1501 1504 1510 1513 1701
PUSH2	2341	1052	0407 1063
PUT	0710	1301	0277 1307 1316
PV0MOV	5552	0501	0474
PXL1	6333	1525	1515
PXL2	6334	1526	1517
P1T037	3425	2127	2106
P10	1173	1666	1575 1576

SYMBOL	VALUE	DEF	REFERENCES
P100	3751	2531	2344
P11	0015	0315	1077 2114
P12	2241	0746	0724
P177	0145	0447	0770 1742 0122
P1777	0144	0446	0555 0616 1203 1752 2067 1625 2305 2777
P2	3456	2164	2117 2122
P20	3100	1631	1547
P200	0147	0451	1013 1026 1737
P2000	0152	0454	0520 0746 0764
P212	0153	0455	1241 2261 1265 1505
P215	0154	0456	1237 2263 1144 1371
P2270	4041	2637	2620
P240	0134	0436	1406 2345 1434
P260	2704	1500	1450 1470
P300	0143	0445	1673 1702
P367A	3450	2156	2121 2136
P377	3077	1630	1560
P3777	0131	0433	0624 0632 1071 1213 1224 1622 2756
P40T57	3412	2114	2111
P400	0124	0426	1562 2405
P4000	0150	0452	0566 0662 0665 1217 1231 0176 0200 0202 0204 2375
P41	3460	2166	2140
P43	3523	2252	2260
P4400	4046	2644	2626
P45	2701	1475	1433
P46	3461	2167	2151
P4774	5023	0066	0103
P4775	5021	0064	0047
P4776	5022	0065	0051
P5	3770	2560	2553
P5000	0142	0444	1054 1561
P53	2703	1477	1447
P54	3455	2163	2147
P57	3457	2165	2125
P6000	0136	0440	0521 0564 1154 1206 1240 1764 0242 1010 1015 1104 1107 1614 1741 2312 2371 2411 2431 2771
P6321	3316	1775	1766
P7	0157	0461	1670 1714 1467 1244 1246
P7400	0155	0457	1535 2010 2623
P76	0127	0431	2272
P7600	0146	0450	0773 0777 1012 1027 1721 2053 0230
P77	0160	0462	0312 0322 0605 0623 1672 1701 2003 2025 2341
P777	0156	0460	1057 0753
RADD	4235	3100	1661 3112
RADDRT	4246	3111	3123
RAND	3713	2461	1663 2464
READ	7774	3612	1134 2051 2603 3166 0202 0477 0576 3526
REJECT	2470	1206	1145 1171
REPUN1	1171	1664	1635
RESET	1551	0226	0404 0232
RESETL	3663	2427	0365 2433
RESET1	0063	0365	0523 1772
RESTOR	1751	0462	0577 1664 0451 0453 0455 0463 0465 0467 0471
RESTO1	0263	0577	0543
RETURN	4051	2647	0420
RET1	0116	0420	2473
R1OR	1600	0263	1660 0272
RSUB	4211	3052	1662 3065
RSUBRT	4223	3064	3077
RTHFT	3336	2015	2007
RWRITE	4163	3002	2663
R1	6233	1400	1357
R2	6235	1402	1361

SYMBOL	VALUE	DEF	REFERENCES
R3	6237	1404	1363
R4	6241	1406	1365
R5	6243	1410	1367
SADR	0023	0324	0613 0641 1163 1165 1202 1204 1207 1210 1211 1212 1214 1220 1221 1222 1223 1225 1232 1233 1235 1236 0510 0511 0513 0514 0516 0521 0524 1141 1153 1155 1163 1165 1175 1204 1216 2370 2373 2374 2401 2402 2414 2415
SADROV	2033	0535	0523
SAMES	3073	1624	1620
SAVE	1736	0447	0602 0456
SAVE1	0265	0602	0605
SCH1	0433	0754	0743
SCLEAR	0132	0434	0342 3253 3410
SCOLON	0200	1455	1525
SCRATC	0025	3574	1323 3245
SCURR	0026	0327	0606 0610 0646 0706 0707 0450 1122 1131 1136 1173 1210
SDEC01	0112	0414	0611 1645 0464 0503 1137 1174
SDEC08	0600	1151	0414 1172 1405 1410
SEARCH	0266	0604	0676 0701 0754 1746
SEARC1	0272	0610	0713
SEAR1	3270	1746	1727
SEMF0G	2573	1355	1346
SEMITX	2561	1340	1345 1351 2144
SEMITZ	3440	2144	2112
SEMPTF	2574	1356	1347
SEND	0027	0330	0711 0056 0502 0532 1133 0467 0511
SETINU	0177	0501	1556
SETORG	1520	0175	0061 0211 0220
SETUSE	3653	2417	2365 2424 2641
SGN	0034	0335	1503 1506 1534 1547 1570 1615 2765
SIT	4315	3176	3046 3160
SKIP	0075	0377	0670 1252 1377 1576 1605 1611 1670 1705 2356 3431
SKIPAS	5435	0334	0312
SKIP2	0764	1404	0377 1412
SL777	4304	3163	3043 3155
SM370	4305	3164	3042 3154
SNUM	0171	0473	0545 1152 1153 1157 2546
SOMEW	4227	3071	3053 3061
SOPS	0062	0364	1250 1666 2202
SPACE	5600	1466	1521 1540 1573
SPACK	3744	2524	0675 2535
SPCUNT	0173	0475	0074 0344 2360 2520 2530 2533
SPECAL	0416	0737	0724 0732
SPT060	1705	0403	0343
SQERR	1702	0400	0354 0355
SQFDRT	1701	0377	0367
SRD1	0115	0417	2421
SREAD1	4275	3153	0417 3161
SRITIC	0113	0415	2364 2650
STAB	0675	1246	1162
STDUMP	1667	0360	0304 0320
STEXD	1175	1670	1245 0535
STGET	1641	0327	0300 0303 0317 0333 0346 0353
STINTO	1624	0311	0302
STLOOP	1616	0303	0325
STNODU	1673	0364	0301 0371
STNOT	1661	0347	0337
STOCHK	3757	2545	0575 2552
STRING	1610	0275	2723
SUBCON	4232	3074	3055
SWITCH	0170	0472	0610 0625 0672
SWOT	1556	0233	0142 0156 0677
SWOTA	2172	0677	0641
SWOUT	4317	3200	3044 3156

SYMBOL	VALUE	DEF	REFERENCES
SWRC	4201	3041	0415 3047 3151
SW1	6035	1202	1151
SW2	6036	1203	1166
SY	0174	0476	0575 0646
SYB	0114	0416	0647
SYCRAP	3373	2060	1771
SYMB	4000	1457	1520 1542 1653
SYMBLP	2402	1120	1224
SYMBU	1503	0160	0416 0144 0145 0146 0154
SYMBUF	3102	1633	0476 0160
SYMFIX	6335	1527	1354
SYML0D	5553	0502	0307
SYMLST	0071	0373	2441
SYMOVR	6336	1530	1355
SYMSAV	5533	0461	0311
SYREAD	3372	2051	1770
SYSIN	3317	1776	0371 2016 2026
TAABA	0362	0700	0715
TABA	3441	2147	2116
TABLE	3271	1750	1654
TACK	1434	0110	0171
TATA	3532	2261	2266
TBCONT	0175	0477	0574 0660 0663 0671 1375 1407 1452 1460 1472
TEMP	0007	0305	0663 0667 1060 1061 1063 1070 1740 1743 0606 0611 0624 0626 0655 1033 1036 2004 2015 2525 2526 2534 3214 3216
TEMPA	2510	1264	
TEMP1	6034	1201	1155 1156 1162 1254
TEM1	0161	0463	0620 0742 2032 0507
TEM1A	0040	0341	1124 1126 1130 1147 1157 1167 1177 1410 1412 1414
TEM2	0162	0464	0626 0741 2034 0512
TEM3	0163	0465	0634 0740 2036 0515
TERMC	0000	0266	0350 0375 0550
TEST	6252	1421	1425 1427
TESTC2	6267	1437	1443 1445
THOU	3570	2317	2763
TIC	2274	1005	0754 0762 1000
TOP	0367	0705	0637
TOUSE	4043	2641	2622
TWOCH	2144	0651	0634
TWOCHR	2073	0600	0652
TYBASE	2400	1546	1400 1403 1406 1410
TYCAR	2510	1236	0402 1245 1264
TYCARI	0100	0402	0310 0363 0635 1117 1403 1664 1712 2172 2354 2507 2612 1046 3470
TYPADD	0622	1173	0413 1175 1243 1244 1302 1310
TYPAD1	0111	0413	0570 1652 0527
TYPE	0021	0322	0745 0752 0763 1006 1200 1205 1215 1226 1237 1241 0454 0470 1007 1103 1740 2412
TYPEA	0014	0314	1176 1177 1762 0452 0466 1013 2304 2310 2372 2377 2400 2406 2407 2410
TYPO	2527	1255	1373 1262 0133 0135 0141 0200 1373 1374 1375 1376 1377 1400 1403 1406 1410
UBITS	4321	3211	0501 3217
UN	1105	1576	2767
UNDERR	2317	1030	1760 1042 1716
UNITAS	4777	0244	
UNREF	3240	1716	1660 1671 1675
UNTRAN	2647	1442	1436 1440 1453
UPLN	3607	2353	2361 2522
USEDNO	4337	3277	2642 1102
USES	4044	2642	2651 2655 2660
USYMB	2000	1461	1517 1543 1734
VADR	0022	0323	0557 0655 1166 1650 0506 1017
VAL	0024	0325	0671 0750 0751 0766 1530 1567 2016 2017 2022 2024 2026 0241 0250 0264 0267 0277 0331 0505 1203 1401 1732 2313
VALK	0025	0326	0653 0670 0247
VASSNO	5603	0564	0562

SYMBOL	VALUE	DEF	REFERENCES
VCLEAN	5602	0562	0571
VERSIO	0017	0235	0251
VIN	5573	0537	0473 0512
VINIT	5565	0514	0513
VL6777	5551	0500	0470 0510
VOUT	5572	0536	0466 0505
VPRSRV	0773	1427	1432 0536
VPRSRW	0777	1437	1430
VREAD	5610	0576	0567 0734
VRSTR	0572	1124	1127 0537
VRSTRR	0576	1134	1125
VSAVE	4331	3243	1126 1431
VTAB	5611	0602	0560 0570
VVINIT	5604	0567	0514
VWRITE	5607	0575	0557 0720
VMOVE	5600	0557	0501
WDH	4042	2640	2625
WDHALF	3351	2030	2000 2020 2640 3541
WHERE	4252	3116	3101 3107
WREAD	4306	3166	3157
WRITE	7775	3613	1437 3002 3051 0476 0575
WWRITE	4210	3051	3045
XBLOC	5154	3270	3067
XBUFIN	5353	3543	3473
XCER	5134	3247	3100 3112 3114 3115 3120 3131 3140 3510
XCHAIN	2536	1274	2623
XCON	5165	3301	3123
XDONE1	5044	3133	3121
XGET	5122	3227	3077 3113 3117 3136 3170 3173 3205 3233 3234 3237 3240
XGETIN	5151	3265	3230
XHALF	5155	3271	3171 3203 3216
XHT	5334	3524	3423
XINIT	2551	1313	1277
XINT01	5034	3122	3116
XL00P1	5011	3077	3105 3111
XL00P2	5031	3117	3130
XL17	5145	3261	
XL4400	5347	3537	3417
XL6	5144	3260	3247
XL6777	5337	3527	3351
XL7400	5346	3536	3414
XL77	5153	3267	3070 3150 3167
XL7770	5342	3532	3357
XM100	5340	3530	3353
XM13	2575	1357	1341
XM26	5335	3525	3430
XM4	5344	3534	3364
XM40	5146	3262	3107
XM43	5152	3266	3231
XM47	5150	3264	3103
XM9	5147	3263	3217
XN	5143	3257	3137 3146 3152
XNM1	5310	3455	3300
XOK1	5025	3113	3101
XP	5157	3273	3221 3533
XPP	2550	1312	1300
XPSEU	2555	1321	1275 1302
XPUT	5064	3161	3074 3127 3134 3165 3166 3200 3207
XP46	2576	1360	1344 1350
XREAD	5336	3526	3347 3424
XRESET	5112	3214	3072 3076 3223
XRIGHT	5104	3202	3172

SYMBOL	VALUE	DEF	REFERENCES
XT	5156	3272	3177 3204
XTH	5333	3523	3422
XTHISB	5166	3307	3071 3151 3350 3523
XXFH	5321	3470	3427 3434
XXGET	5354	3544	3340
XXL	5345	3535	3413
XXLOOP	5214	3355	3506
XXLP	5225	3366	3376
XXMESS	5277	3442	3432
XXM43	5341	3531	3343
XXN	5202	3342	3257 3354 3365 3375 3401 3412 3505
XXN1	5160	3274	
XXN2	5161	3275	
XXN3	5162	3276	
XXN4	5163	3277	
XXP	5343	3533	3362
XXRET	5172	3322	3475
XXT	5271	3432	3436 3437
XXXP	5164	3300	3124 3125
XXXR	5200	3340	3345
XXXX	5000	3066	1312 3322
XXY	5327	3505	3374 3405
XX1	5350	3540	3415
XX2	5351	3541	3416
XX3	5352	3542	3420
YP1	5566	0520	0472 0507
YREAD	5550	0477	0506
YWRITE	5547	0476	0471
ZASSIF	5425	0324	0305