

Hall IC Series Application Notes



Magneto-electric Conversion Switch

Request for your special attention and precautions in using the technical information and semiconductors described in this book

- (1) An export permit needs to be obtained from the competent authorities of the Japanese Government if any of the products or technical information described in this book and controlled under the "Foreign Exchange and Foreign Trade Law" is to be exported or taken out of Japan.
- (2) The technical information described in this book is limited to showing representative characteristics and applied circuits examples of the products. It neither warrants non-infringement of intellectual property right or any other rights owned by our company or a third party, nor grants any license.
- (3) We are not liable for the infringement of rights owned by a third party arising out of the use of the technical information as described in this book.
- (4) The products described in this book are intended to be used for standard applications or general electronic equipment (such as office equipment, communications equipment, measuring instruments and household appliances). Consult our sales staff in advance for information on the following applications:
 - Special applications (such as for airplanes, aerospace, automobiles, traffic control equipment, combustion equipment, life support systems and safety devices) in which exceptional quality and reliability are required, or if the failure or malfunction of the products may directly jeopardize life or harm the human body.
 - Any applications other than the standard applications intended.
- (5) The products and product specifications described in this book are subject to change without notice for modification and/or improvement. At the final stage of your design, purchasing, or use of the products, therefore, ask for the most up-to-date Product Standards in advance to make sure that the latest specifications satisfy your requirements.
- (6) When designing your equipment, comply with the guaranteed values, in particular those of maximum rating, the range of operating power supply voltage, and heat radiation characteristics. Otherwise, we will not be liable for any defect which may arise later in your equipment.
Even when the products are used within the guaranteed values, take into the consideration of incidence of break down and failure mode, possible to occur to semiconductor products. Measures on the systems such as redundant design, arresting the spread of fire or preventing glitch are recommended in order to prevent physical injury, fire, social damages, for example, by using the products.
- (7) When using products for which damp-proof packing is required, observe the conditions (including shelf life and amount of time let standing of unsealed items) agreed upon when specification sheets are individually exchanged.
- (8) This book may be not reprinted or reproduced whether wholly or partially, without the prior written permission of Matsushita Electric Industrial Co., Ltd.

If you have any inquiries or questions about this book or our semiconductor products, please contact one of our sales offices listed on the back or Semiconductor Company's Sales Department.

Contents

Hall IC Applications in Various Fields	2
Operating Theory.....	3
The Applications	4
The Explanation	8
Cautions on Use	16
Trouble Shooting	18
Individual Specification.....	19
AN48800A	20
AN48810B	24
AN48820A	28
AN48830B	32
AN48840B	36

Hall IC Applications in Various Fields

Flip type cellular phone



Video camera with LCD display

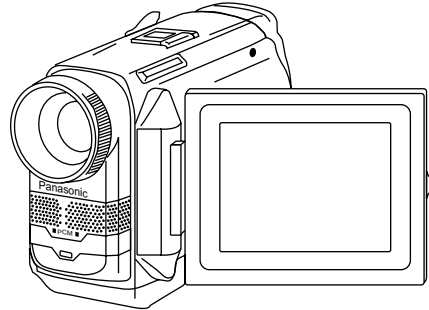

Brushless motor

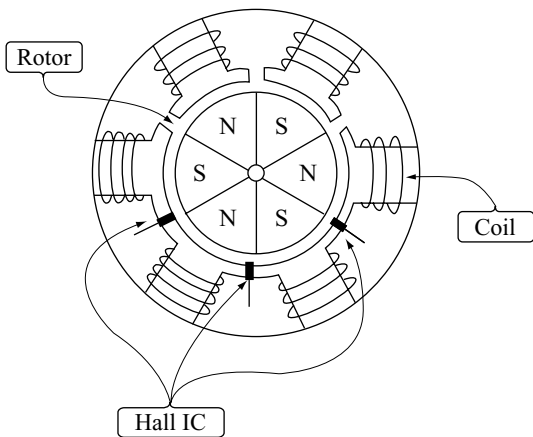

Key board

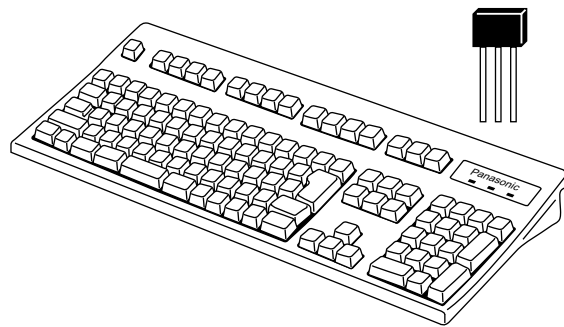

Position or level sensor

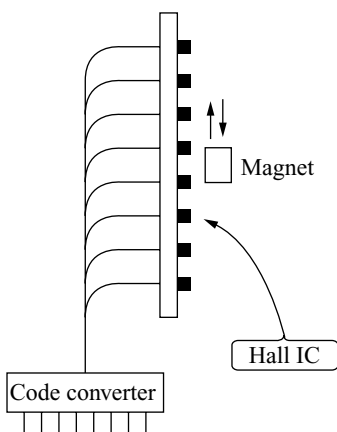

Tape counter for audio, Auto reverse sensor

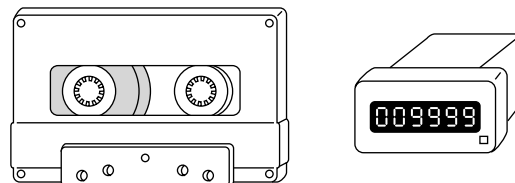

MPU fan motor

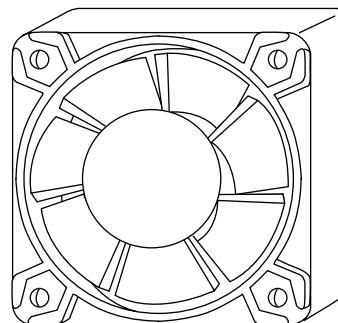

Rotary sensor

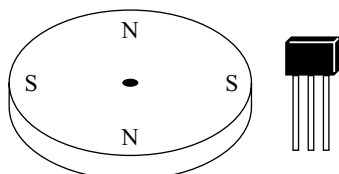

Operating Theory

The Hall IC produced by Matsushita Electronics Corporation is made from silicon, same as general IC (Bipolar IC and CMOS IC). The sensor block and peripheral circuits (amplifier and Schmidt trigger) are designed on the same chip.

The construction of Hall IC and operating theory

The theory of Hall element is that the electrode A, B, C and D are made on a resistor (the same diffusion process as resistors of ICs) shown in figure 1-a; then the voltage is applied between A and B, and the current flows as a result; in this conditions, if magnetic flux is given vertically to the resistor, by Fleming's left hand rule (Shown in figure 2), force 'F' works from D to C direction, and the current density will be $C > D$ between C and D, and potential difference will be generated. (Shown in figure 1-b.)

This phenomenon is called "Hall effect" and the potential difference is called Hall voltage. This phenomenon was discovered by Mr. E. H. Hall.

Regarding the performance of Hall element, the Hall voltage of compound semiconductor like GaAs, InAs, InSb (whose electron mobilities are large) is larger and more advantageous. Although Hall voltage of Si is small, the silicon Hall element can be made together with the amplifier circuit and Schmidt trigger circuit on the same chip due to using the bipolar diffusion process.

This is an easy-to-use sensor because the sensor block and peripheral circuit are built in on the same single chip.

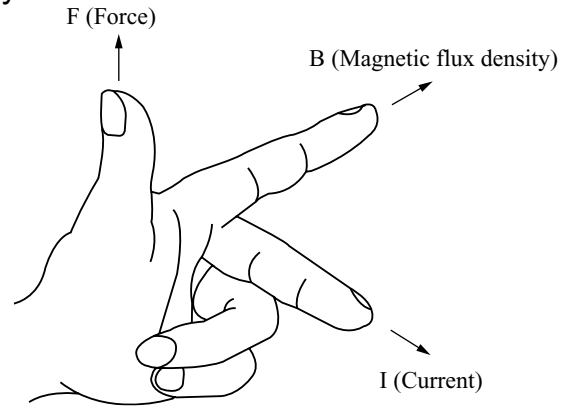

Figure 2 Fleming's left hand rule

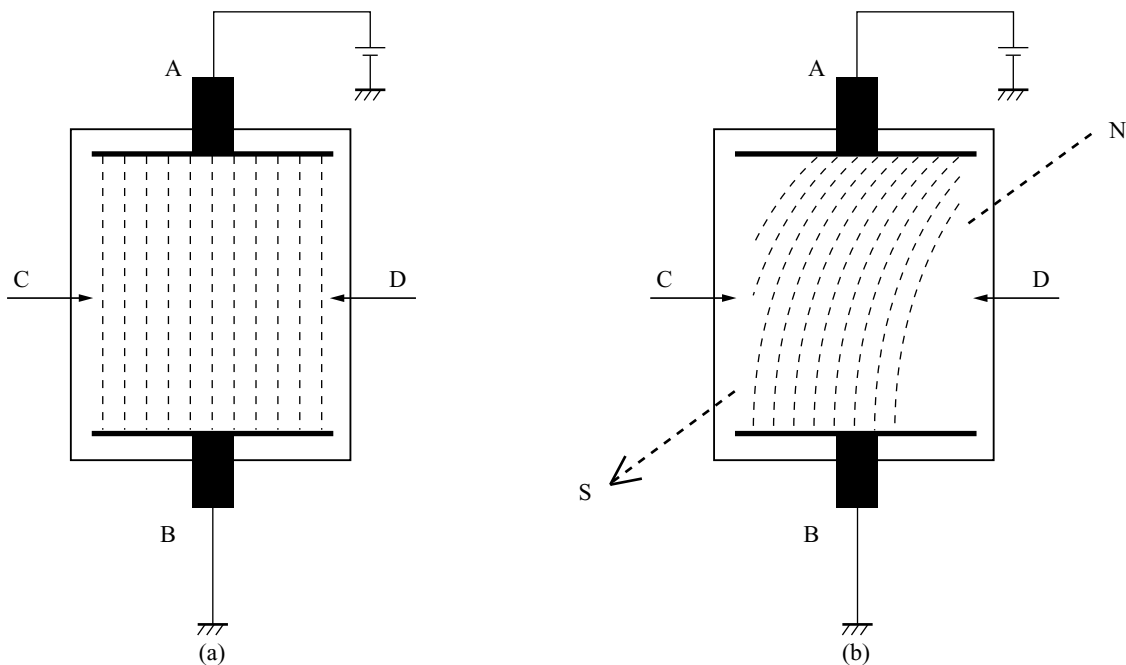

Figure 1 Operating theory of Hall IC

The Applications

The Hall ICs are applied in the various fields.
Please design your products referring to the use method and remarks.

1. The application for FDD index sensor

To reduce the variation of the pulse position of index sensor, 2) of alternating field operation type is much better than 1) of one-way magnetic field operation type.

The accuracy will be increased if the changes of magnetic density at the changing point from S to N are steep.
Especially, the use of two magnets will be more efficient than using one magnet.

1) Unipolar (One-way magnetic field operation type)

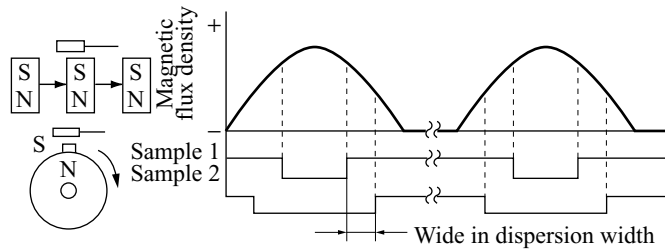

2) Bipolar (Alternating magnetic field operation type)

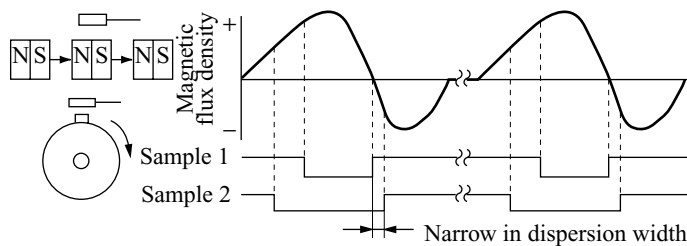

Figure 3

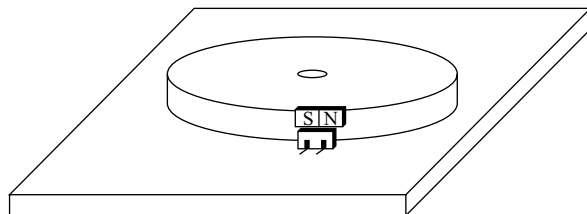

Figure 4

2. The application for a flip type cellular phone

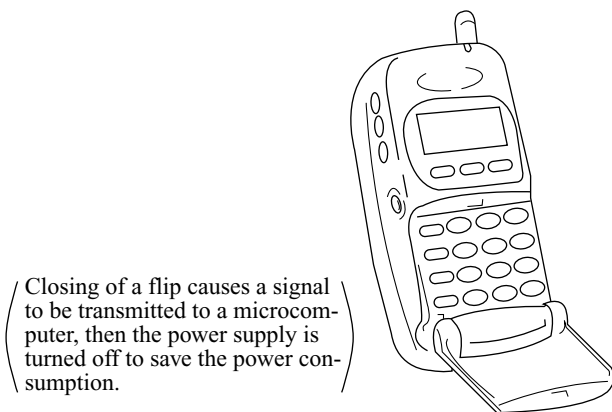

Figure 5

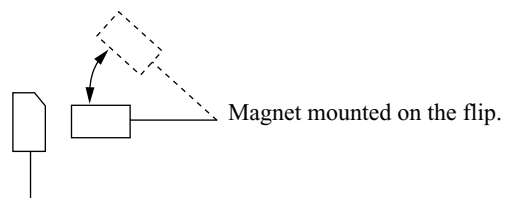

Figure 6

The Hall IC is a kind of high sensitivity, low current consumption and one-way magnetic field operation type. For example: AN48800 series.

3. The application for micro-switch

We recommend the alternating field operation to maintain the stroke accuracy and to make On/Off stroke small.

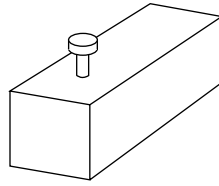

Figure 7

The two same size magnets are used to make a steep change of magnetic flux density. Usually N-pole faces to Hall IC and let S-pole face to it for operation (switching).

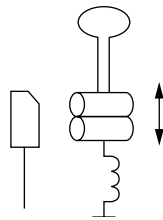

Figure 8

4. The application for the detection of motor rotation

For washing machines, massage equipment of fan motors.

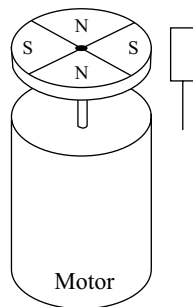

Figure 9

5. The application for the coil current phase switching sensor of brushless motor

According to the rotation of magnet, the coil current phase is switched.

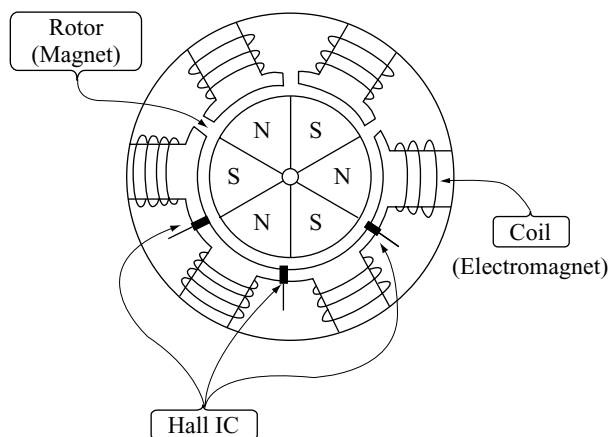

Figure 10

The Application

6. The application for:

- The tape counter for audio equipment
- Auto reverse sensor
- Auto reverse and auto stop sensor for answering machine

This function is used to detect the tape end by the rotating magnet according to tape running. In case of tape end detection, it couldn't be decided whether the tape has stopped at S-pole or N-pole, so count it as shown in figure 12 or count the number of pulse or pulse width per fixed interval of time with a microcomputer.

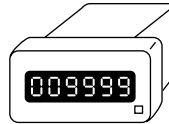
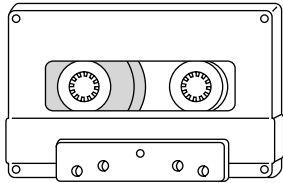
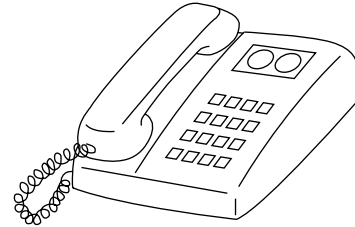

Figure 11



As shown in figure 12, this is used with 'C' cut, so that it becomes low-level when the magnet stops. ('R' is pulled up to 'V_{CC}' and high-level is obtained when the magnet stops.)

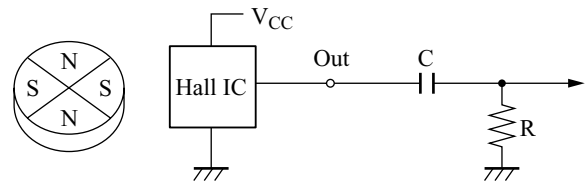

Figure 12

7. The application for a box fan motor

The fan motors of two-phase systems.

The fan motor of box type is usually the brushless motors of two-phase systems.

The Hall IC detects the rotary position of rotor magnet like the brushless motors of three-phase systems.

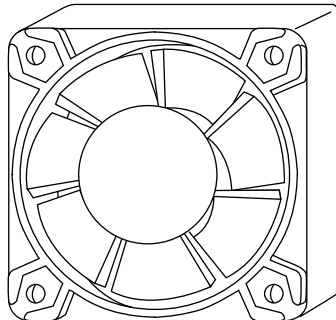

Figure 13

8. The application for the reciprocating motion switch and sensor

If the ON-position of the Hall IC's output may well be coarse in using Hall IC for a reciprocal switch or sensor, the one-way type Hall IC is recommended. Use the alternating field operation type to improve the accuracy of the ON-position.

The output of the Hall IC will be switched on only when the S-pole goes across the Hall IC if the 3 magnets are arranged as shown below.

[Excellent in positional accuracy]

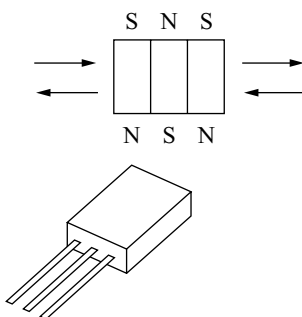

Hall IC of alternating magnetic field operation type

[Coarse in positional accuracy]

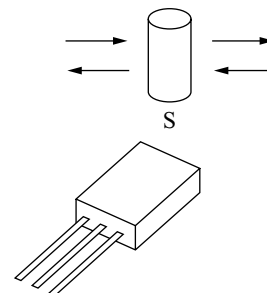

Hall IC of one-way magnetic field operation type

Figure 14

9. The distinction of magnet S- or N-pole

Prepare the Hall IC and attach the LED to Hall IC's output as shown below.

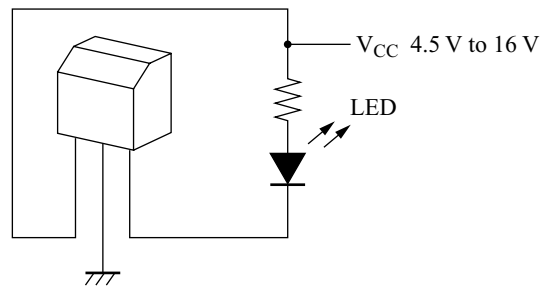

Figure 15

If the magnet approaches the marking side of Hall IC and LED lights up, the near side to the Hall IC is the S-pole.

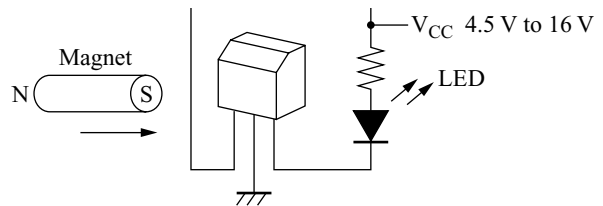

Figure 16

Paint the S-pole, then you can surely find which is which. If you use short magnet, it's convenient to do like figure 17.

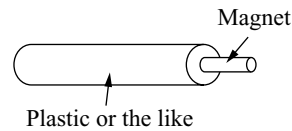
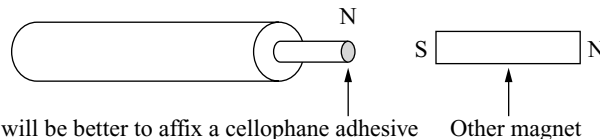

Figure 17

The S-pole of the other magnet will easily be found, if the N-pole is protruded.



It will be better to affix a cellophane adhesive tape to this face.
(For easy separability of the other magnet attracted to the N-pole.)

Figure 18

10. In case of a little bit insufficient magnet flux density

The flux density of magnet on the Hall IC is a little bit increased by the method of figure 19 because the line of magnetic force easily gathers at the blocks of ferrite or soft iron in which the magnetic flux lines apt to go through. Run the mass production after fully confirming the flux density of the magnet to be actually used through taking its data.

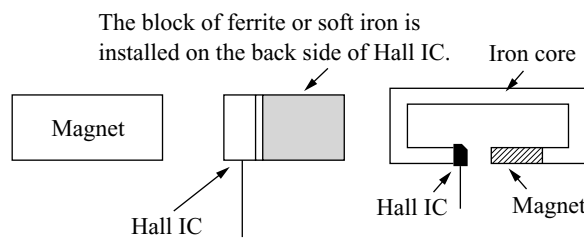

Figure 19

The Explanation

The Hall IC converts the magnetic force to the electric signal, and outputs it. It is essential to know not only the characteristics of Hall IC but the characteristics of magnet.

As the characteristics of magnet differs depending on their materials, shapes and magnetic conditions, please take the data of characteristics of the magnet to be used. This is the most important conditions to produce the highly reliable equipment.

1. How to read the Hall IC specifications

1.1 The example of products specifications

■ Electrical characteristics example for a product with a pull-up resistor $T_a = 25^\circ\text{C}$

Parameter	Symbol	Condition	Min	Typ	Max	Unit
Operating magnetic flux density	$B_{1(L-H)}$	$V_{CC} = 12\text{ V}$	-17.5	-5.0	—	mT
	$B_{2(H-L)}$	$V_{CC} = 12\text{ V}$	—	5.0	17.5	mT
Hysteresis width	BW	$V_{CC} = 12\text{ V}$	7.0	10.0	—	mT
Output voltage	V_{OL}	$V_{CC} = 4.5\text{ V to }16\text{ V}, I_O = 12\text{ mA}, B = 17.5\text{ mT}$	—	—	0.4	V
	V_{OH}	$V_{CC} = 16\text{ V}, I_O = -30\text{ }\mu\text{A}, B = -17.5\text{ mT}$	14.6	—	—	V
		$V_{CC} = 4.5\text{ V}, I_O = -30\text{ }\mu\text{A}, B = -17.5\text{ mT}$	2.9	—	—	V
Output short-circuit current	$-I_{OS}$	$V_{CC} = 16\text{ V}, V_O = 0\text{ V}, B = -17.5\text{ mT}$	0.4	—	0.9	mA
Supply current	I_{CC}	$V_{CC} = 16\text{ V}$	—	—	6	mA
		$V_{CC} = 4.5\text{ V}$	—	—	5.5	mA

Note) For circuit currents, '+' denotes current flowing into the IC and '-' denotes current flowing out of the IC.

■ Electrical characteristics example for a product with an open collector output $T_a = 25^\circ\text{C}$

Parameter	Symbol	Condition	Min	Typ	Max	Unit
Operating magnetic flux density	$B_{1(L-H)}$	$V_{CC} = 12\text{ V}$	-17.5	-5	—	mT
	$B_{2(H-L)}$	$V_{CC} = 12\text{ V}$	—	5	17.5	mT
Hysteresis width	BW	$V_{CC} = 12\text{ V}$	7	10	—	mT
Output voltage	V_{OL}	$V_{CC} = 4.5\text{ V to }16\text{ V}, I_O = 12\text{ mA}, B = 17.5\text{ mT}$	—	—	0.4	V
Output current	I_{OH}	$V_{CC} = 4.5\text{ V to }16\text{ V}, V_O = 16\text{ V}, B = -17.5\text{ mT}$	—	—	10	μA
Supply current	I_{CC}	$V_{CC} = 16\text{ V}$	—	—	6	mA
		$V_{CC} = 4.5\text{ V}$	—	—	5.5	mA

Note) For circuit currents, '+' denotes current flowing into the IC and '-' denotes current flowing out of the IC.

1.2 How to read the example of products specification

Parameter	Descriptions
Operating magnetic flux density B_{H-L}	Flux density that changes the output from high-level to low-level.
Operating magnetic flux density B_{L-H}	Flux density that changes the output from low-level to high-level.
17.5 mT -17.5 mT	The mark is '+' when the face side of Hall IC is S-pole (accordingly the back-side is N). Conversely it is '-' when the face side is N-pole (the back-side is S).
B_{H-L} 17.5 mT	The Hall IC's output goes from high-level to low-level if the flux density is 17.5 mT or more.
B_{L-H} -17.5 mT	The Hall IC's output goes from low-level to high-level if the flux density is -17.5 mT or less.
Operating magnetic flux density	Operational flux density is stipulated by the flux density applied to the chip surface of Hall IC. It is not the flux density at the surface of the magnet.
Hysteresis width	The differences between B_{H-L} and B_{L-H} .

Note) Unit of flux density: 1 Gauss = 10^{-4} T (tesla) (International Unit System (SI))

■ The example of a product with a pull-up resistor

Parameter	Descriptions
Output voltage: V_{OL}	It is stipulated that when output intake current is 12 mA, $V_{CE(sat)}$ of the output transistor in the IC should be 0.4 V or less. To reduce the V_{OL} to 0.4 V or less, it is necessary to reduce the intake current to 12 mA or less. (Please use the output current of 12 mA or less.)
Output voltage: V_{OH}	Following is stipulated: 14.6 V or more if output level is high-level and $V_{CC} = 16$ V; 2.9 V or more if $V_{CC} = 4.5$ V.
Output short-circuit current: I_{OS}	Specifies the current when the output pin is short-circuited to GND. This is equivalent to stipulating the resistance value of the built-in pull-up resistor. ($R = V_{CC} / I_{OS}$)
Supply current: I_{CC}	The value of current flowing into IC, when output is high-level.

■ The example of open collector type (the difference from with the pull-up resistor)

Parameter	Descriptions
Output current: I_{OH}	The stipulation for the maximum value of leak current of the built-in output transistor.

1.3 The definition of '+' and '-' in the operating flux density

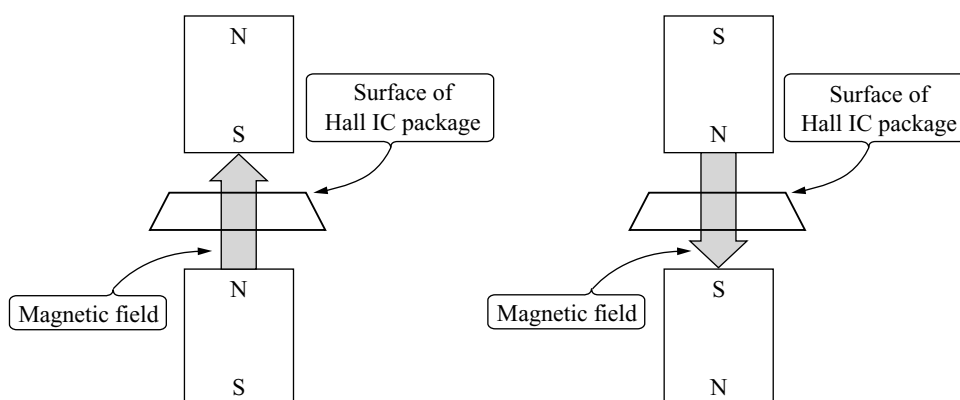

- 1) In case the magnetic flux density is plus 2) In case the magnetic flux density is minus

Figure 20

Note) Except the mini-mold package, the IC chip face comes to the face (type name marked) of the package.

The Explanation

2. Alternating magnetic field operation IC

The Hall IC that operates in the magnetic field which changes continuously S → N → S → N.

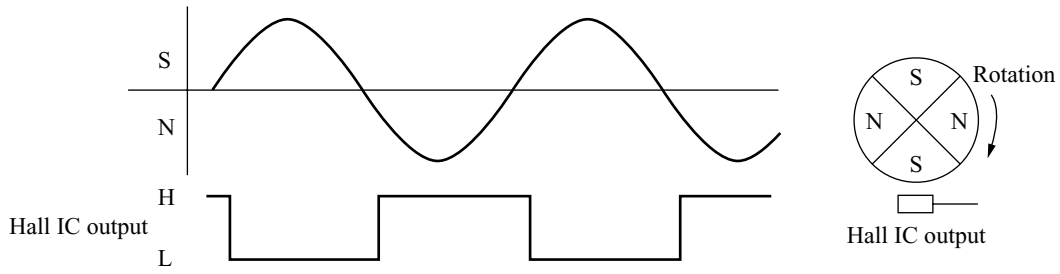

Figure 21

3. One-way magnetic field operation IC

The Hall IC that operates only by S-pole or N-pole.

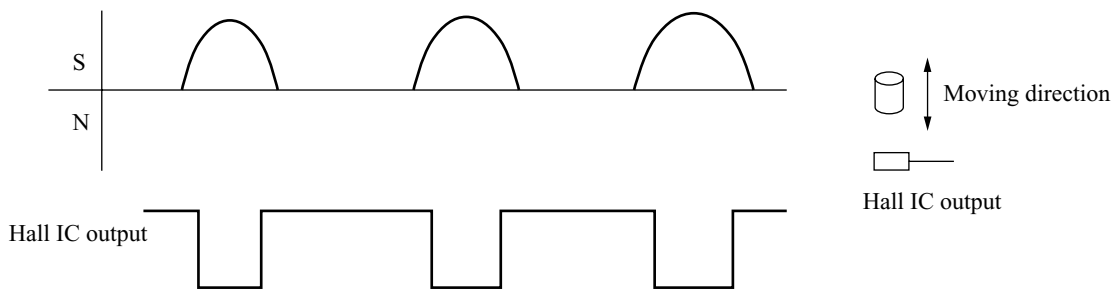

Figure 22

4. Measuring method for the operating flux density

Use the electromagnet whose sectional area is large enough to be free from any effects of the IC's location. By using above mentioned electromagnet, it is able to measure the sensitivity of Hall IC without regard to IC's distances from magnet.

<Measuring method>

- 1) Please prepare the data of the current which flows in the coils and responding flux density.
- 2) By changing of the power supply for the magnet, you can change the current flows in coils. In consequence, you can change the flux density of the electromagnet.
- 3) The current which flows in the coil could be read as the voltage which was generated between both ends of the resistor. Adjust the value of this resistor so that 100 mT becomes 1.000 V. From the above mentioned process, you could be able to read by the voltmeter as 1 mV = 0.1 mT. (Unless the relation between flux density and voltage is determined beforehand, it is impossible to gain the necessary linearity.)

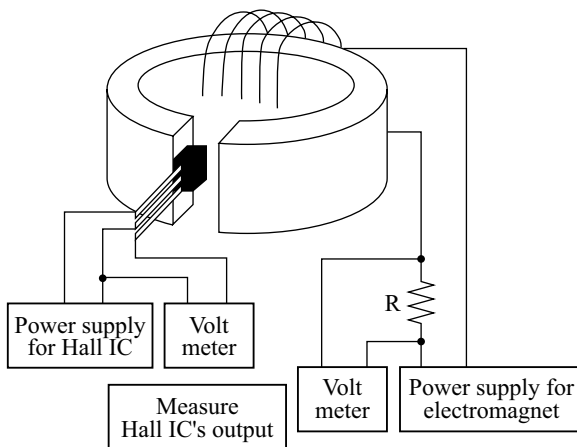

Figure 23

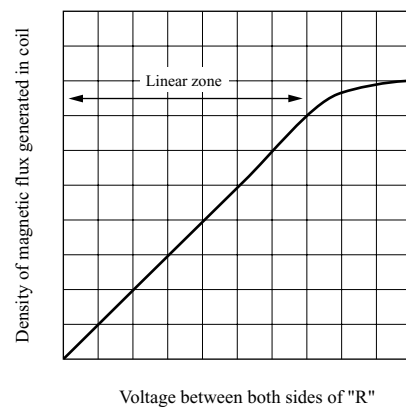

Figure 24

5. About the sensitivity variation

Hall IC has the variation in its operating sensitivities. Design the equipment so as to be able to absorb or ignore such variation.

5.1 Alternating magnetic field operation type

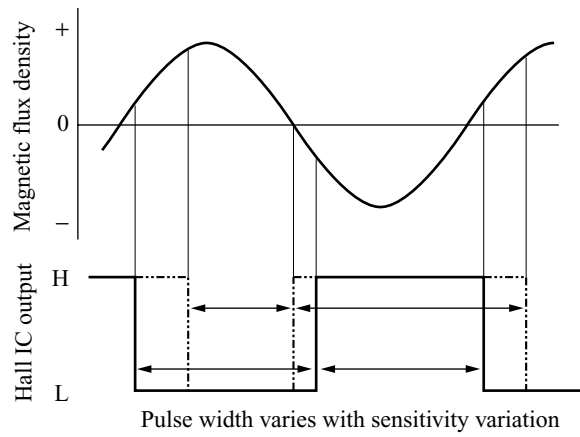

Figure 25

5.2 One-way magnetic field operation type

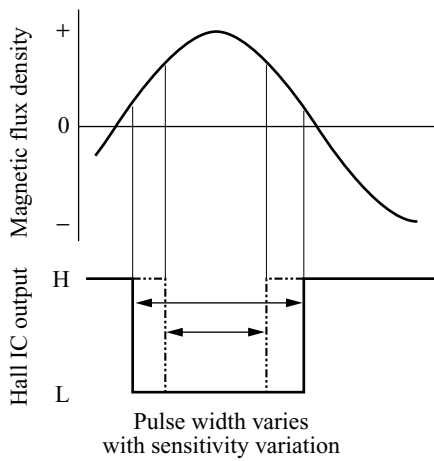

Figure 26

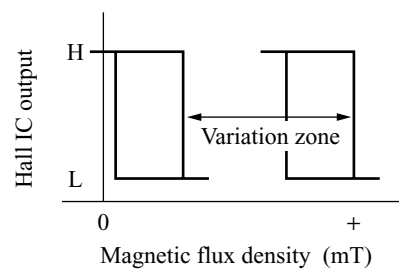

Figure 27

The Explanation

5.3 Maximum operating frequency

In Hall IC, the power output will be in the shape of rectangular wave, because of Schmidt trigger, even if the magnet rotation frequency is small.

Actually, if the output wave is enlarged, the delay time occurs in both rise and fall times as shown in figure 29 – 2 'a' and 'c'. At quicker change more than this delayed time, the IC output can not reach high-level or low-level. So, please use lower frequency than this time.

Though, when the rise and fall time is supposed to be $3 \mu\text{s} + 40 \text{ ns} \approx 4 \mu\text{s}$, maximum frequency will be 250 kHz, please use the frequency within 100 kHz with a margin.

For example,

If the disc type magnet rotates with 60 000 rpm (rotation frequency per minute)

$$60\,000 \div 60 = 1\,000 \text{ rotations/second}$$

Suppose the number of magnetic pole is 20 poles at the most.

$$1\,000 \times 20 \div 2 = 10\,000 \text{ (Hz)} \quad (1 \text{ Hz at S and N})$$

Therefore, the average operational speed of Hall IC is high enough for the mechanism and has enough capacity.

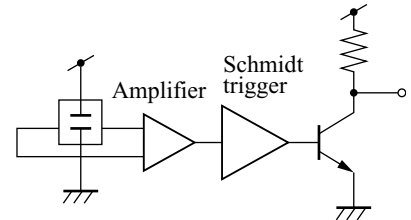

Figure 28 Block diagram of IC interior

Note) Because AN48800 series runs in an intermittent operation, time of the intermittent time or more is necessary for the operating time.

- Switching characteristic of Hall IC

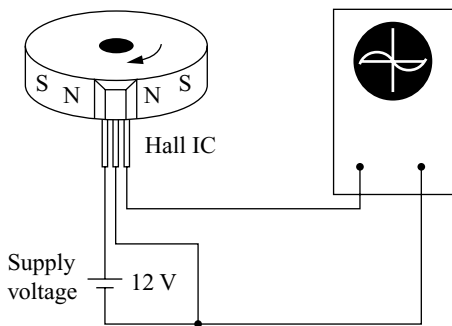
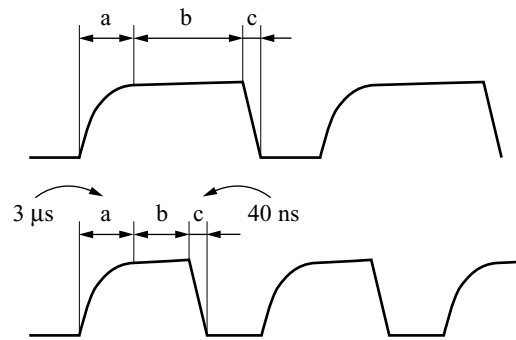

Figure 29 – 1 Measuring circuit



In case the supply voltage is constant, only the space 'b' changes with variation in the rotation frequency.

$$\left(\begin{array}{l} \text{In case of } V_{CC} = 12 \text{ V,} \\ a = 3 \mu\text{s (typ.)}, c = 40 \text{ ns (typ.)} \end{array} \right)$$

Figure 29 – 2 Switching waveforms

5.4 How to take magnet data

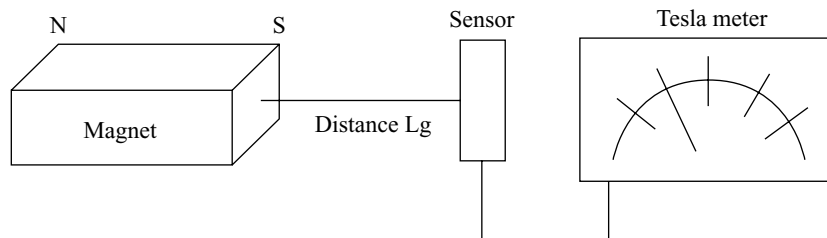

Figure 30

- 1) Remove gradually the sensor from surface of magnet, measure the data of flux density in each position. (figure 31)
- 2) Take the variation data of magnetizer condition. (figure 31)
- 3) Take the temperature characteristics of above 1) and 2). (figure 32)

5.4 How to take magnet data (continued)

- Magnet data example 1
(variation of magnetization)

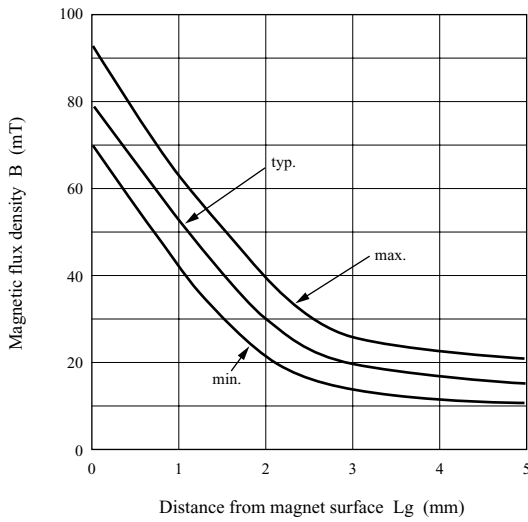

Figure 31

- Magnet data example 2
(Temperature characteristics)

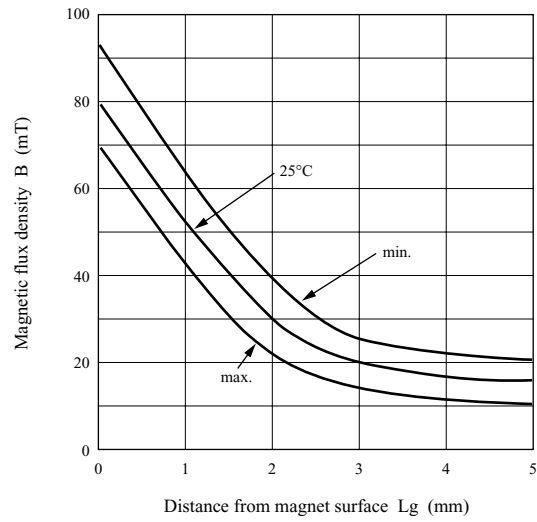

Figure 32

Generally, the rare earth magnet is ferromagnetism. The ferrite type can't gain the large flux density. However, this type is economical to use.

Even the magnet size is the same, the flux density depends on the each material.

- The comparison between the ferrite magnet and manganese aluminium magnet.

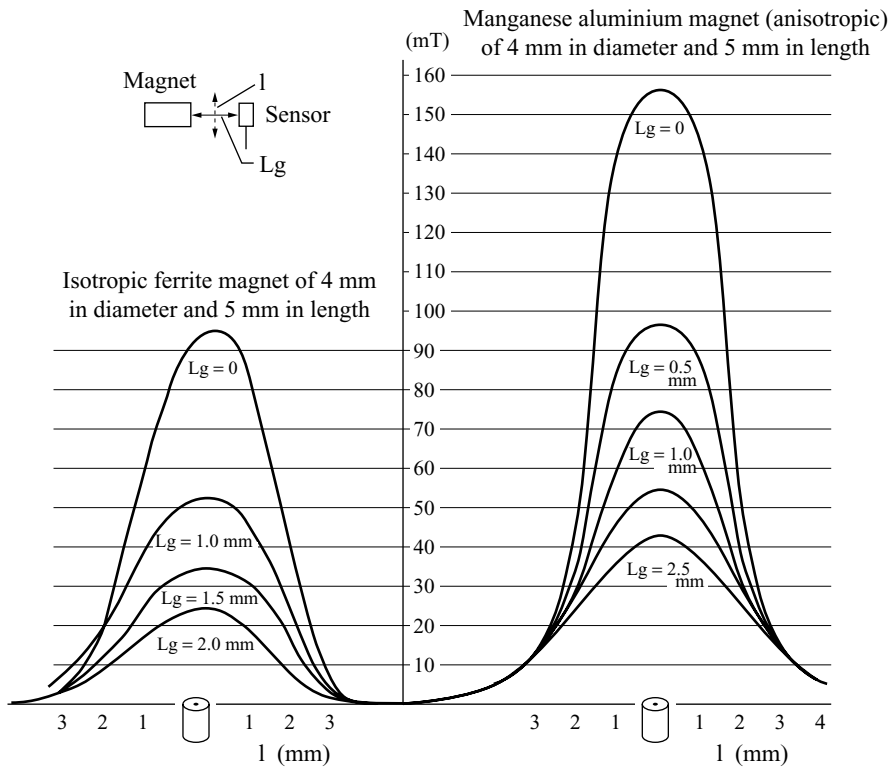

Figure 33

Even when the size is the same, the characteristics differs in material.

Even the material is the same, the flux density differs in the shape and the number of magnetizing pole.

Please design after testing of the characteristics of magnet which will be really used.

The Explanation

5.4 How to take magnet data (continued)

<Reference data>

- Measured example of manganese aluminium magnet

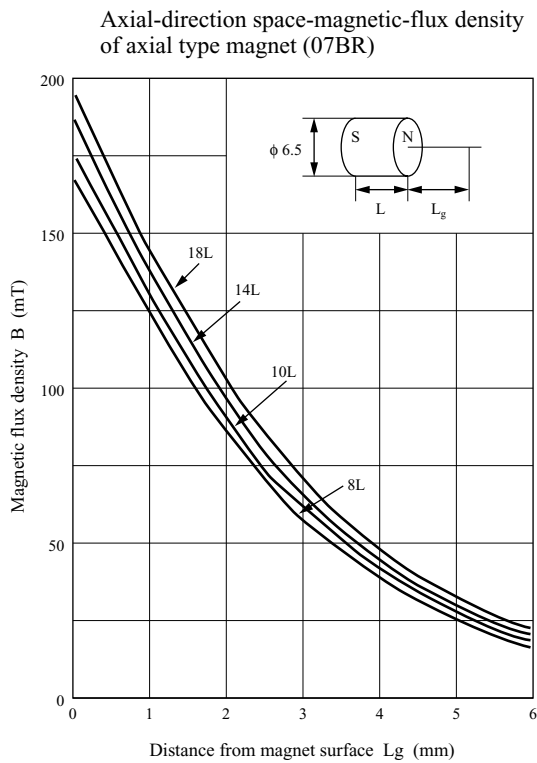

Figure 34

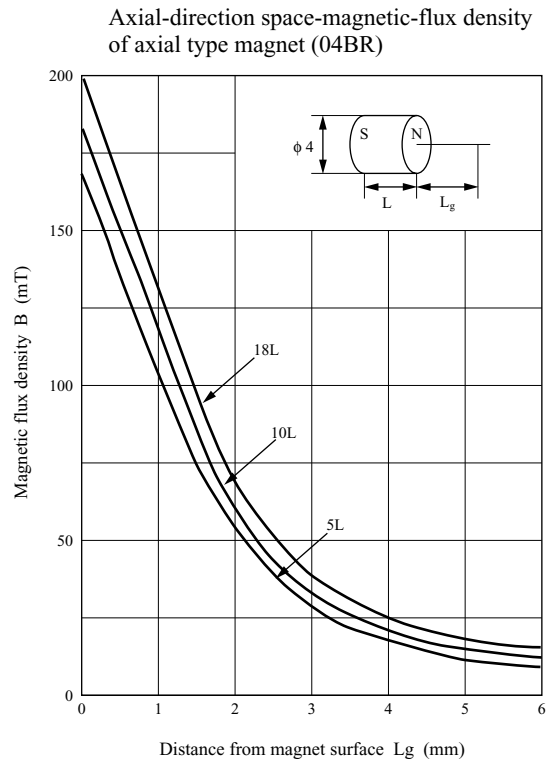

Figure 35

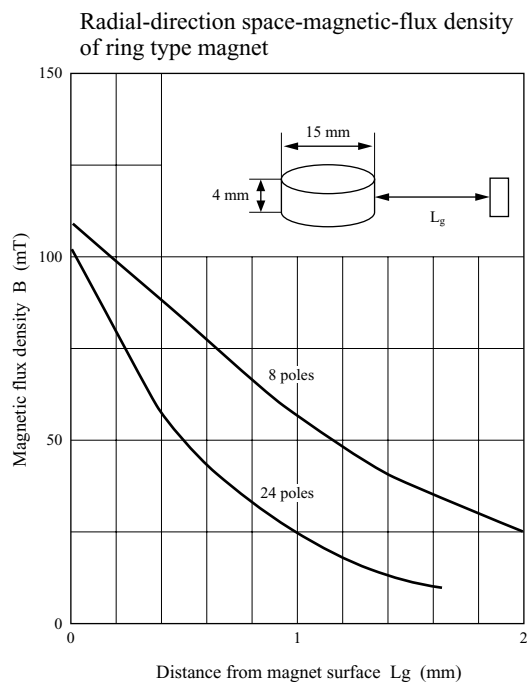

Figure 36

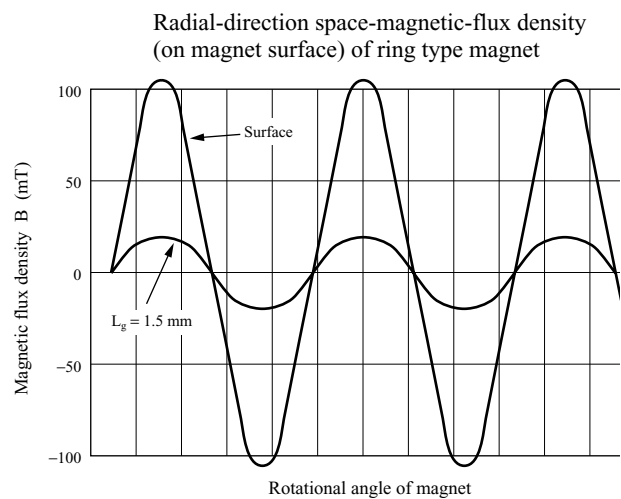

Figure 37

If you could prepare the data of the magnet described above, you can judge on the graph paper whether or not this Hall IC can be used.

And if you don't conduct above survey, it may occur in mass production line that the IC can't operate due to the insufficient magnetic flux density.

5.5 Operating point of Hall IC

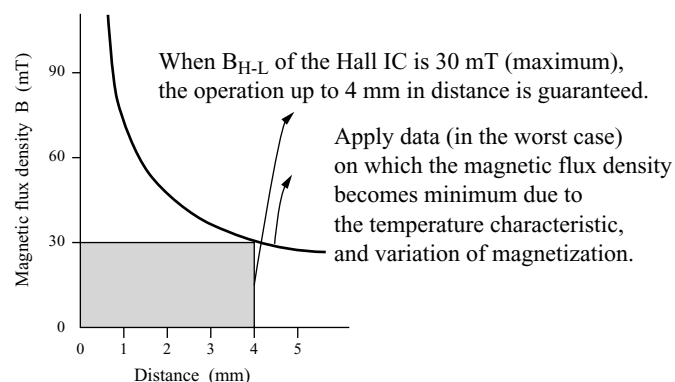

Figure 38

The sensitivities of Hall ICs don't mean the value on the surface of Hall ICs, but the value on the chip of Hall ICs.

The operation sensitivity of Hall IC varies depending on the temperature characteristic or mechanical/thermal stress. Take sufficient margin.

Sample)

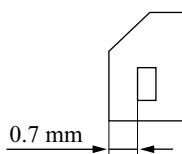

Figure 39

When the distance between the magnet surface and the surface of Hall IC package is 1 mm.

$$1 \text{ mm} + 0.7 \text{ mm} = 1.7 \text{ mm}$$

Please don't forget to measure the value of actual measurement on magnet flux density. Especially, though the type of disc-like magnetized has large flux density, it may be reduced extremely if the distance is increased only slightly.

Cautions on Use

The Hall ICs are often used to detect movement. In such cases, the position of the Hall IC may be changed by exposition to shock or vibration over a long period of time, and it causes the detection level change. To prevent this, fix the package with adhesives or fix it on a dedicated case.

1. A case using an adhesive

Some kinds of adhesive generate corrosive gas (such as chloric gas) during curing. This corrosive gas corrodes the aluminum on the surface of the Hall IC, and may cause a functional defect of disconnection.

If Hall IC is to be sealed after installation, attention should be given to the adhesive or resin used for peripherals and substrate cleaner, as well as to the adhesive used for Hall IC installation. Please confirm the above matter to those manufacturers before using.

We could not select the specified adhesive, for we find it difficult to guarantee the ingredient of each adhesive.

2. A case bending lead wire

Bend the lead wire without stressing the package.

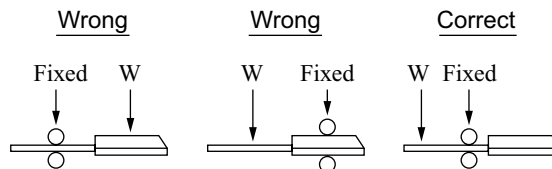

Bending method of lead wire

Figure 40

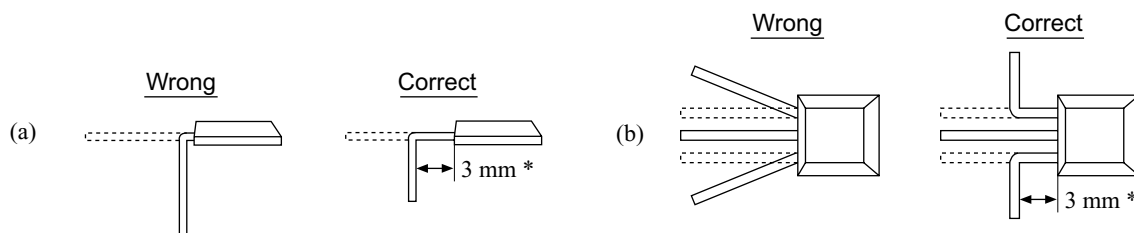

Bending position of lead wire

Note) *: The distance can be within 3 mm, if no stress is applied to the resin mold by tightly fixing the lead wires with a metallic mold or the like.

Figure 41

3. Power supply line/Power transmission line

If a power supply line/power transmission line becomes longer, noise and/or oscillation may be found on the line. In this case, set the capacitor of 0.1 μ F to 10 μ F near the Hall IC to prevent it.

If a voltage of 18 V or more is thought to be applied to the power supply line (flyback voltage from coil or the ignition pulse, etc.), avoid it with external components (capacitor, resistor, Zener diode, diode, surge absorbing elements, etc.).

4. On mounting of the surface mount type package (MINI-3DRA, SMINI-5DA)

When mounted on the printed circuit board, the Hall IC may be highly stressed by the warp that may occur from the soldering. This may also cause a change in the operating magnetic flux density and a deterioration of its resistance to moisture.



Figure 42

5. V_{CC} and GND

Do not reverse V_{CC} and GND. If the V_{CC} and GND pins are reversely connected, this IC will be destroyed. If the IC GND-pin voltage is set higher than other pin voltage, the IC configuration will become the same as a forward biased diode. Therefore, it will turn on at the diode forward voltage (approximately 0.7 V), and a large current will flow through the IC, ending up in its destruction. (This is common to monolithic IC.)

6. Cautions on power-on of Hall IC

When a Hall IC is turned on, the position of the magnet or looseness may change the output of a Hall IC, and a pulse may be generated. Therefore, care should be given whenever the output state of a Hall IC is critical when the supply power is on.

7. Fixing a Hall IC

When the Hall IC of an insertion type package installed by soldering the lead wire only is to be used under vibration, fix it firmly with a holder. Otherwise, vibration may cause metal fatigue in the lead wire of Hall IC, resulting in wire breakage.

8. On fixing a Hall IC to holder

When a Hall IC is mounted on the printed circuit board with a holder and the coefficient of expansion of the holder is large, the lead wire of the Hall IC will be stretched and it may give a stress to the Hall IC.

If the lead wire is stressed intensely due to the distortion of holder or board, the adhesives between the package and the lead wire may be weakened and cause a minute gap resulting in the deterioration of its resistance to moisture.

Sensitivity may also be changed by this stress.

9. On using flux in soldering

Choose a flux which does not include ingredients from halogen group, such as chlorine, fluorine, etc. The ingredients of halogen group may enter where the lead frame and package resin joint, causing corrosion and the disconnection of the aluminum wiring on the surface of an IC chip.

10. In case of the magnetic field of a magnet is too strong

Output may be inverted when applying a magnetic flux density of 100 mT or more. Accordingly, magnetic flux density should be used within the range of 100 mT.

11. On mounting, deburring and soldering of insertion type package

If the leads of a Hall IC in an insertion type package are inserted up to their root part through holes on the printed circuit board, abnormal stress is applied to the package and the reliability of the Hall IC is likely to deteriorate. So, when mounting each Hall IC of the insertion type, insert the leads in due degree at which the bottom face of the package is separated at least 2 mm from the top face of the PCB.

Also note that burrs of epoxy resin may be left sticking to the lead wires. (We are trying to remove such burrs as much as possible in the deburring process, but in some cases, they are not perfectly removable.)

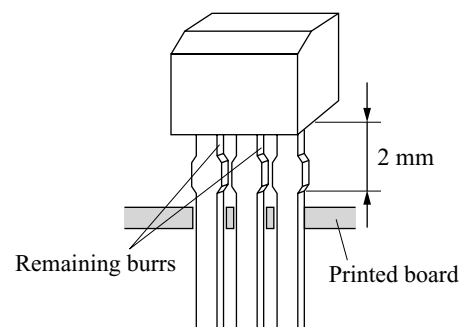

When soldering the leads, remember to separate the soldering position by 2 mm or more from the resin part of the package.

Figure 43

12. On surface treatment of mini-mold package

Surface treatment is available in either smooth or dull finish.

13. On soldering of the surface mount type package

Surface mounting type Hall ICs are apt to change its electrical characteristics due to the stress from soldering at mounting. Therefore, avoid the mounting by flow (dipping) and a soldering iron. Please mount it by reflow soldering abiding by its recommended conditions.

Trouble Shooting

When using Hall ICs, it is possible to prevent trouble beforehand by merely taking slight measures. To make the concerned equipment trouble-free, design it by referring to the examples of Hall IC trouble cases listed below and the cautionary instructions described later.

- **Most frequently occurred troubles**

[Case 1] The operation of every Hall IC manufactured by way of trial was normal, but some Hall ICs put to mass production did not operate.

(Causes) • The magnetic flux density of the magnet was insufficient.

- The temperature characteristics of the Hall IC and the magnet were ignored.

(Reasons) • There was no data on the magnetic flux density of the magnet, and mass production was conducted in way of referring to just the equipment used in design and test production.

- In some ferrite magnets, the magnetic flux density drastically decreases at the high temperature side. But this property was not duly taken into consideration.

- The magnetic flux density was insufficient because the distance was set between the magnet and Hall IC package surface, and the distance to the sensor was not considered.

(Remedial measures) • The magnet was exchanged to the magnet of large magnetic flux density.

- A block of ferrite or soft iron was affixed to the reverse of the Hall IC.

- The distance between the magnet and the Hall IC was diminished.

- **Trouble cases occurred less frequently but furnishes useful hints**

[Case 2] Some Hall ICs became inoperative on the market.

(Causes) • The materials of the adhesive agents and the resin molds used for fixation of the Hall ICs subsequently generated hydrogen gas and other halogen gas. This gas intruded into the IC interior and corroded the aluminum wires on the IC surface.

(Remedial measures) • We ceased to use those resin materials which generate such gas as is corrosive to metals.

[Case 3] Some Hall ICs became inoperative on the market.

(Causes) • The surge voltage ascribable to the counter electromotive force of motors and solenoids was applied to these Hall ICs and it broke the IC wires because the Hall ICs were being used in the vicinity of motors and solenoids.

(Remedial measures) • The power supply line was separated from those of the motors and the solenoids.

- Surge absorbing elements were additionally inserted in the Hall ICs.

[Case 4] Many defective products were detected in the mass production process.

(Causes) • Abnormal stress was applied to many Hall ICs and their sensitivity changed because no jig was used in the lead wire bending process.

(Remedial measures) • We introduced a new method of lead forming by a jig so that abnormal stress is never applied to each IC.

[Case 5] Many defective products were found in the market.

(Causes) • The chloric solvent included in the flux used for the soldering work gradually intruded into the IC interior with the lapse of time, and corroded the aluminum wires on the chip surface.

(Remedial measures) • Choose a flux which does not include ingredients from the halogen group, such as chlorine, fluorine and the like.

Individual Specification

AN48800A	Low current consumption, high sensitivity CMOS Hall IC. One-way magnetic field operation.....	20
AN48810B	Low current consumption, high sensitivity CMOS Hall IC. One-way magnetic field operation.....	24
AN48820A	Low current consumption, high sensitivity CMOS Hall IC. One-way magnetic field operation.....	28
AN48830B	Low current consumption, high sensitivity CMOS Hall IC. One-way magnetic field operation.....	32
AN48840B	Low current consumption, high sensitivity CMOS Hall IC. Alternating magnetic field operation.....	36

AN48800A

Low current consumption, high sensitivity CMOS Hall IC
One-way magnetic field operation

Overview

The AN48800A is a Hall IC (a magnetic sensor) which has 2 times or more sensitivity and a low current consumption of about one three-hundredth compared with our conventional one.

In this Hall IC, a Hall element, a offset cancel circuit, an amplifier circuit, a sample and hold circuit, a Schmidt circuit, and output stage FET are integrated on a single chip housed in a small package by IC technique.

Features

- High sensitivity (6 mT max.) due to offset cancel circuit and a new sample and hold circuit
- Small current by using intermittent action (10 μ A typ.)
- Small package (SMD)
- Open drain output

Applications

- Flip type cellular phone, digital video camera

Block Diagram

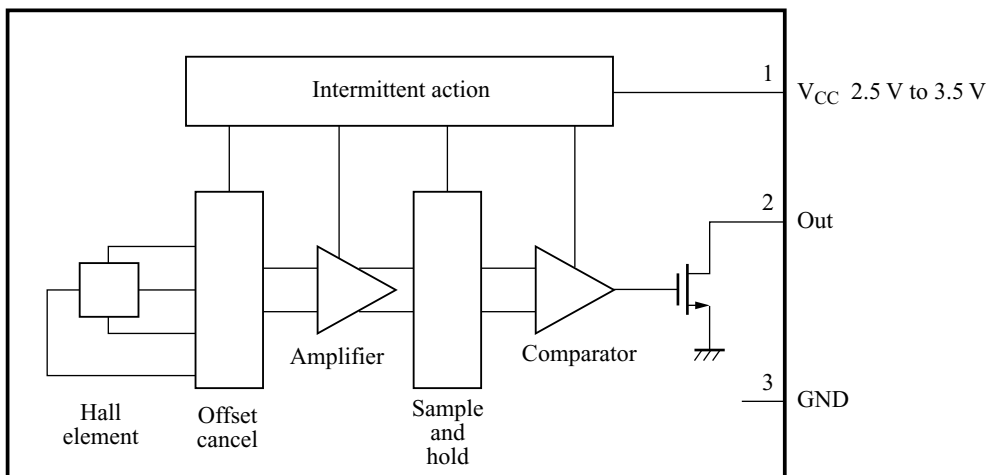

Note) The magnetism detection time should be longer than one intermittent action cycle (On = 200 μ s and Off = 51 ms).

Pin Descriptions

Pin No.	Symbol	Description
1	V _{CC}	Power supply
2	Out	Output
3	GND	Ground

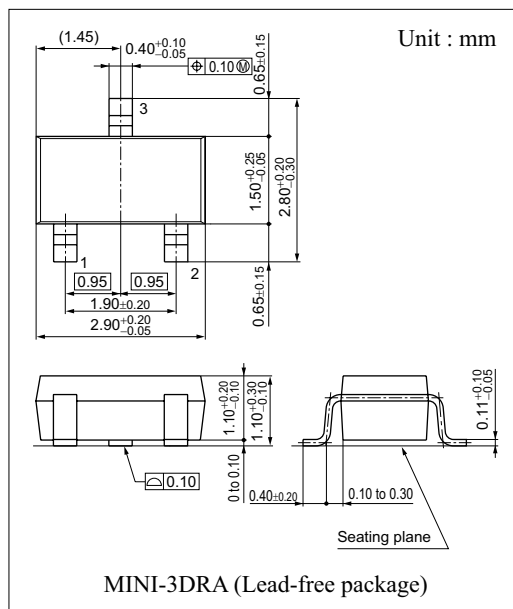

■ Absolute Maximum Ratings

Parameter	Symbol	Rating	Unit
Supply voltage	V_{CC}	5	V
Output voltage	V_{OUT}	5	V
Supply current	I_{CC}	5	mA
Output current	I_{OUT}	30	mA
Power dissipation *1,*2	P_D	60	mW
Operating ambient temperature *1	T_{opr}	-20 to +75	°C
Storage temperature *1	T_{stg}	-55 to +125	°C

Note) *1: Except for the power dissipation, operating ambient temperature and storage temperature, all ratings are for $T_a = 25^\circ\text{C}$.

*2: $T_a = 75^\circ\text{C}$. For the independent IC without a heat sink. Please use within the range of power dissipation, referring to $P_D - T_a$ curve.

■ Recommended Operating Range

Parameter	Symbol	Range	Unit
Supply voltage	V_{CC}	2.5 to 3.5	V

■ Electrical Characteristics $T_a = 25^\circ\text{C} \pm 2^\circ\text{C}$

Parameter	Symbol	Conditions	Min	Typ	Max	Unit
Operating magnetic flux density 1 *1	B_{H-L}	$V_{CC} = 3\text{ V}$	—	—	6	mT
Operating magnetic flux density 2 *2	B_{L-H}	$V_{CC} = 3\text{ V}$	0.5	—	—	mT
Output voltage	V_{OL}	$V_{CC} = 3\text{ V}, I_O = 5\text{ mA}, B = 6.0\text{ mT}$	—	0.1	0.3	V
Output current	I_{OH}	$V_{CC} = 3\text{ V}, V_O = 3\text{ V}, B = 0.5\text{ mT}$	—	—	10	μA
Supply current 1 *3	I_{CCAVE}	$V_{CC} = 3\text{ V}, B = 0.5\text{ mT}$	—	10	15	μA

Note) *1: Symbol B_{H-L} stands for the operating magnetic flux density where its output level varies from high to low.

*2: Symbol B_{L-H} stands for the operating magnetic flux density where its output level varies from low to high.

*3: $I_{CCAVE} = \{I_{CCON} \times t_{ON} + I_{CCOFF} \times t_{OFF}\} / \{t_{ON} + t_{OFF}\}$

• Design reference data

Parameter	Symbol	Conditions	Min	Typ	Max	Unit
Hysteresis width 1	BW	$V_{CC} = 3\text{ V}$	—	1.2	—	mT
Supply current 2	I_{CCON}	$V_{CC} = 3\text{ V}, B = 0.5\text{ mT}$	—	2	—	mA
Supply current 3	I_{CCOFF}	$V_{CC} = 3\text{ V}, B = 0.5\text{ mT}$	—	3	—	μA
Operating time	t_{ON}	$V_{CC} = 3\text{ V}$	—	200	—	μs
Stop time	t_{OFF}	$V_{CC} = 3\text{ V}$	—	51	—	ms

Note) It will operate normally in approximately 51 ms after power on.

Individual Specification

■ Technical Data

- Position of a Hall element (unit in mm)

Distance from a package surface to sensor part: 0.39 mm (reference value)

A Hall element is placed on the shaded part in the figure.

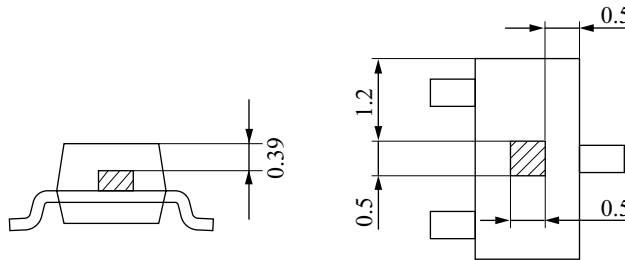

- Magneto-electro conversion characteristics

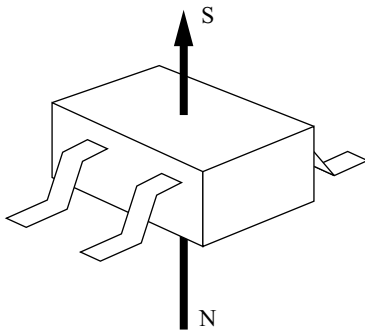

Direction of applied magnetic field

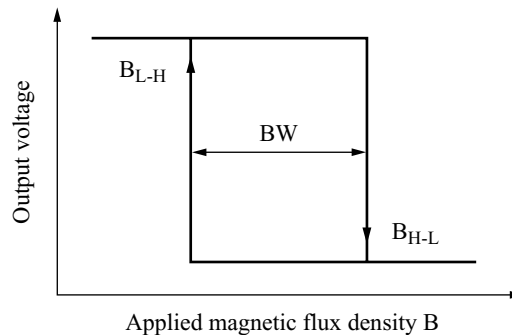

Operating magnetic flux density

- Simple polarity distinction method of mounting magnet to product incorporating Hall IC

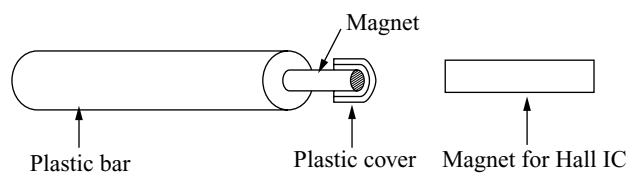

A magnet, which is used in pair with a Hall IC, can be mounted to a product incorporating a built-in Hall IC (e.g., a cellular phone) smoothly and correctly with a simple tool. The polarity of the magnet (hereafter referred to as Hall IC magnet) will be automatically discriminated.

This tool is a plastic bar, one end of which is attached with a small magnet (hereafter referred to as plastic bar magnet), as shown in the above illustration. The plastic bar magnet, the polarity of which is known, is secured on the bar with a plastic cover. When the plastic bar magnet is located close to the Hall IC magnet, the Hall IC magnet will be attracted to the plastic bar magnet. The contact side of the Hall IC magnet is different in polarity from that of the plastic bar magnet. As a matter of course, the polarity of the Hall IC magnet will be known then. The Hall IC magnet can be mounted to the appliance in this state. The attraction force of the plastic bar magnet is rather weak due to the plastic cover on it. Therefore, the plastic bar can be separated from the Hall IC magnet with ease after the Hall IC magnet is mounted properly.

■ Technical Data (continued)

• Main characteristics

Operating magnetic flux density — Supply voltage

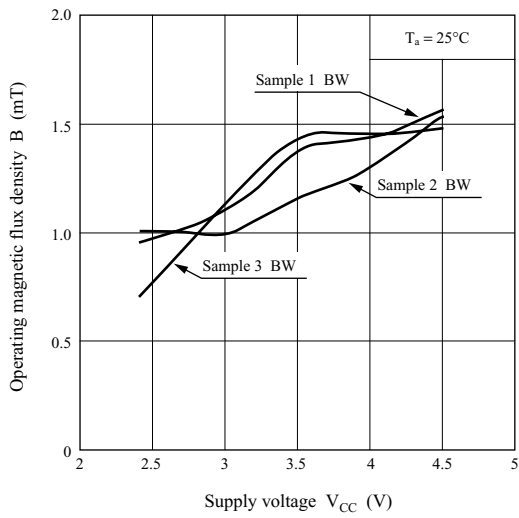

Operating magnetic flux density — Ambient temperature

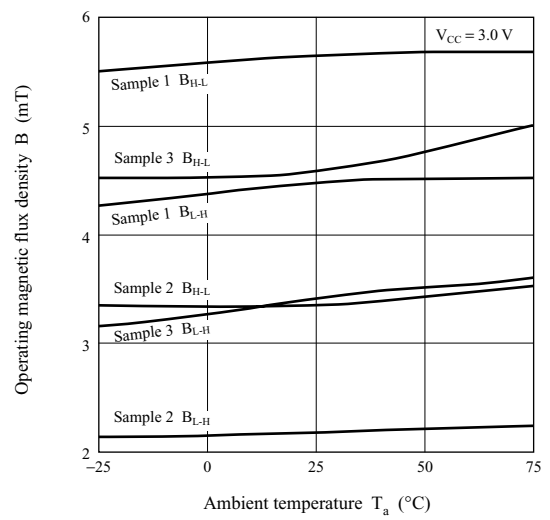

Operating magnetic flux density — Supply voltage

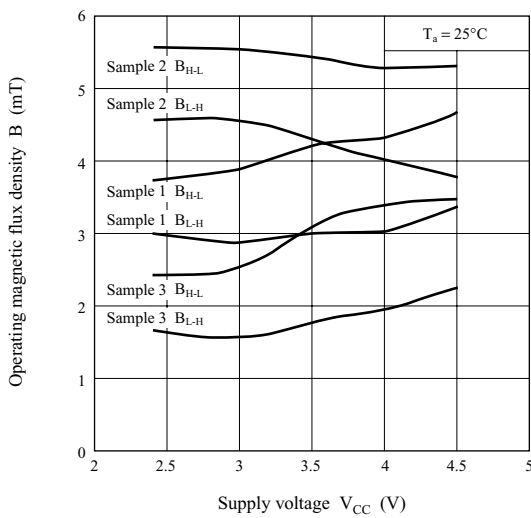

Average consumption current — Supply voltage

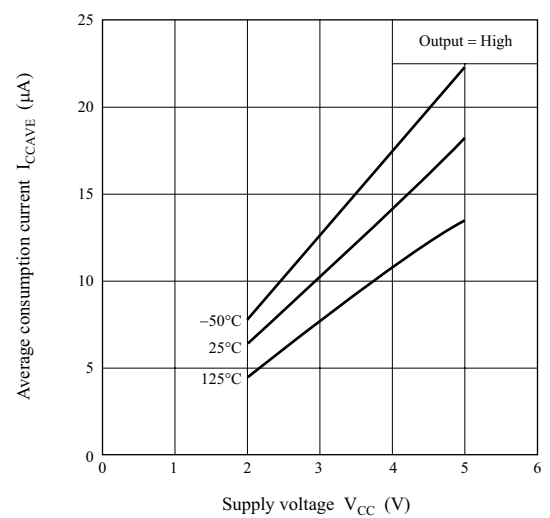

Low-level output voltage — Supply voltage

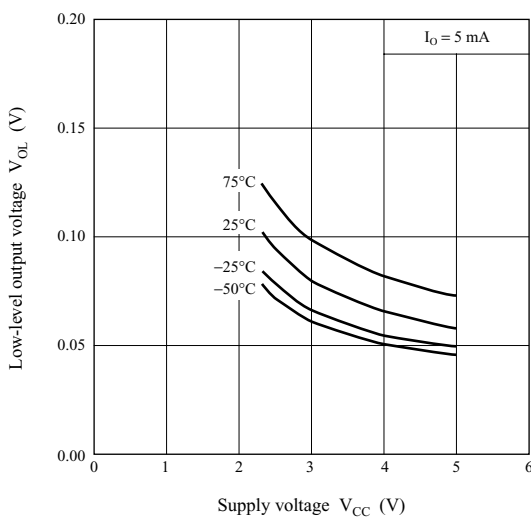

Low-level output voltage — Ambient temperature

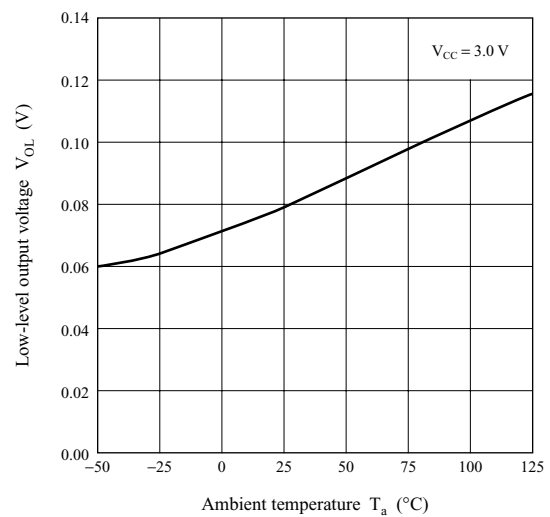

AN48810B

Low current consumption, high sensitivity CMOS Hall IC
One-way magnetic field operation

Overview

The AN48810B is a Hall IC (a magnetic sensor) which has 2 times or more sensitivity and a low current consumption of about one three-hundredth compared with our conventional one.

In this Hall IC, a Hall element, a offset cancel circuit, an amplifier circuit, a sample and hold circuit, a Schmidt circuit, and output stage FET are integrated on a single chip housed in a small package by IC technique.

Features

- High sensitivity (6 mT max.) due to offset cancel circuit and a new sample and hold circuit
- Small current by using intermittent action (10 μ A typ.)
- Small package (SMD)
- CMOS inverter output

Applications

- Flip type cellular phone, digital video camera

Block Diagram

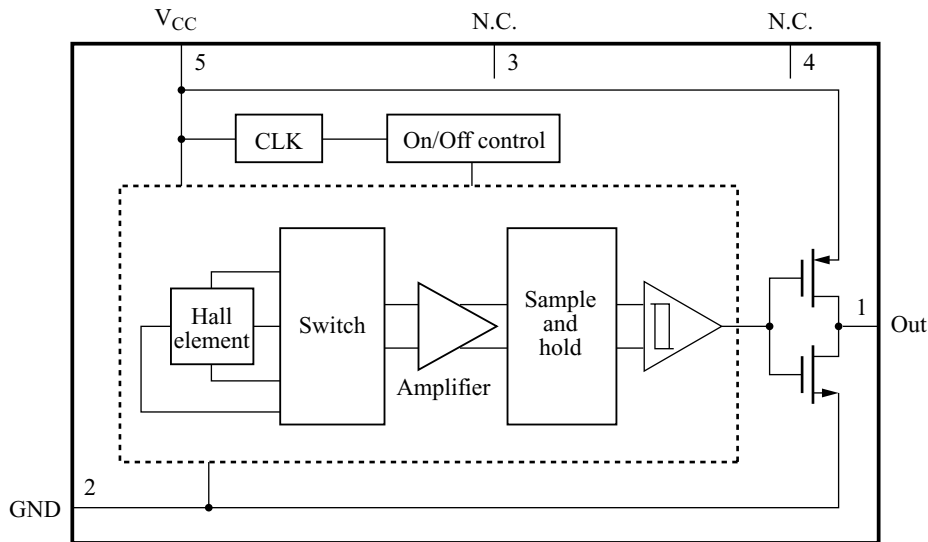

Note) The magnetism detection time should be longer than one intermittent action cycle (On = 200 μ s and Off = 51 ms).

Pin Descriptions

Pin No.	Symbol	Description	Pin No.	Symbol	Description
1	Out	Output	4	N.C.	—
2	GND	Ground	5	V _{CC}	Power supply
3	N.C.	—			

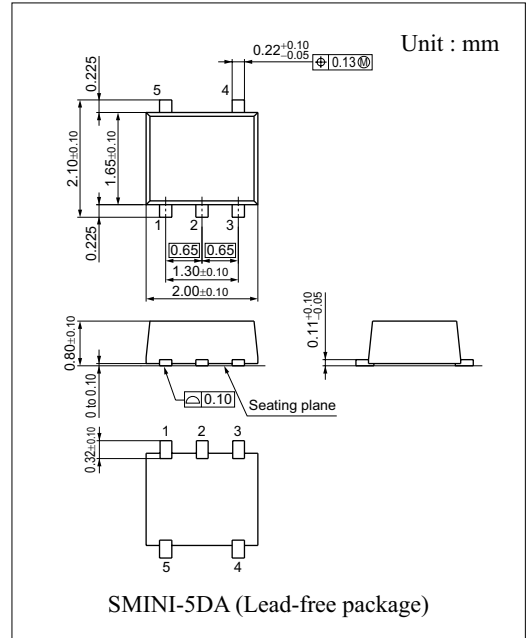

■ Absolute Maximum Ratings

Parameter	Symbol	Rating	Unit
Supply voltage	V_{CC}	5	V
Output voltage	V_{OUT}	5	V
Supply current	I_{CC}	5	mA
Output current	I_{OUT}	15	mA
Power dissipation *1,*2	P_D	60	mW
Operating ambient temperature *1	T_{opr}	-20 to +75	°C
Storage temperature *1	T_{stg}	-55 to +125	°C

Note) *1: Except for the power dissipation, operating ambient temperature and storage temperature, all ratings are for $T_a = 25^\circ\text{C}$.

*2: $T_a = 75^\circ\text{C}$. For the independent IC without a heat sink. Please use within the range of power dissipation, referring to $P_D - T_a$ curve.

■ Recommended Operating Range

Parameter	Symbol	Range	Unit
Supply voltage	V_{CC}	2.5 to 3.5	V

■ Electrical Characteristics $T_a = 25^\circ\text{C} \pm 2^\circ\text{C}$

Parameter	Symbol	Conditions	Min	Typ	Max	Unit
Operating magnetic flux density 1 *1	B_{H-L}	$V_{CC} = 3\text{ V}$	—	—	6	mT
Operating magnetic flux density 2 *2	B_{L-H}	$V_{CC} = 3\text{ V}$	0.5	—	—	mT
Output voltage 1	V_{OL}	$V_{CC} = 3\text{ V}, I_O = 2\text{ mA}, B = 6.0\text{ mT}$	—	0.1	0.3	V
Output voltage 2	V_{OH}	$V_{CC} = 3\text{ V}, I_O = -2\text{ mA}, B = 0.5\text{ mT}$	2.7	2.9	—	V
Supply current 1 *3	I_{CCAVE}	$V_{CC} = 3\text{ V}, B = 0.5\text{ mT}$	—	10	15	μA

Note) *1: Symbol B_{H-L} stands for the operating magnetic flux density where its output level varies from high to low.

*2: Symbol B_{L-H} stands for the operating magnetic flux density where its output level varies from low to high.

*3: $I_{CCAVE} = \{I_{CCON} \times t_{ON} + I_{CCOFF} \times t_{OFF}\} / \{t_{ON} + t_{OFF}\}$

• Design reference data

Parameter	Symbol	Conditions	Min	Typ	Max	Unit
Hysteresis width	BW	$V_{CC} = 3\text{ V}$	—	1.2	—	mT
Supply current 2	I_{CCON}	$V_{CC} = 3\text{ V}, B = 0.5\text{ mT}$	—	1	—	mA
Supply current 3	I_{CCOFF}	$V_{CC} = 3\text{ V}, B = 0.5\text{ mT}$	—	3	—	μA
Operating time	t_{ON}	$V_{CC} = 3\text{ V}$	—	200	—	μs
Stop time	t_{OFF}	$V_{CC} = 3\text{ V}$	—	15	—	ms

Note) It will operate normally in approximately 51 ms after power on.

■ Technical Data

• Position of a Hall element (unit in mm)

Distance from a package surface to sensor part: 0.31 mm (reference value)

A Hall element is placed on the shaded part in the figure.

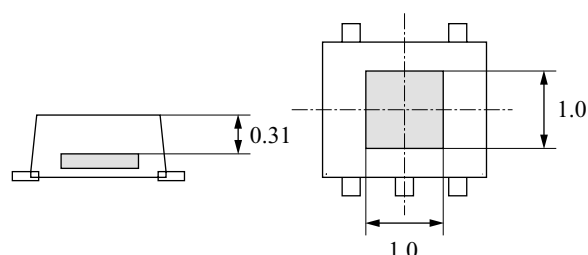

Individual Specification

■ Technical Data (continued)

- Magneto-electro conversion characteristics

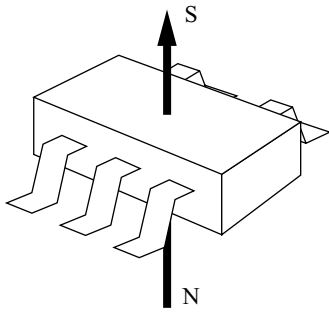

Direction of applied magnetic field

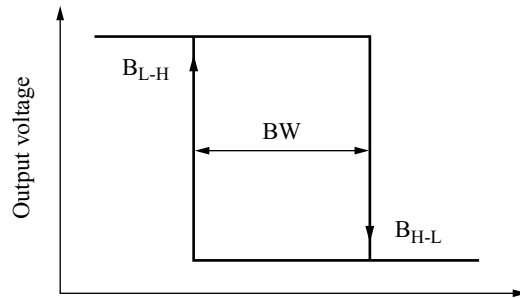

Applied magnetic flux density B

Operating magnetic flux density

- Simple polarity distinction method of mounting magnet to product incorporating Hall IC

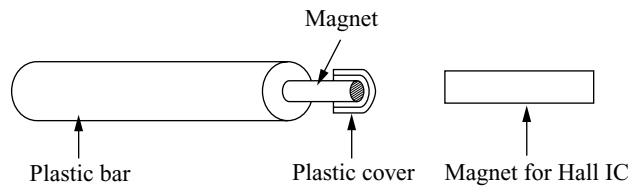

A magnet, which is used in pair with a Hall IC, can be mounted to a product incorporating a built-in Hall IC (e.g., a cellular phone) smoothly and correctly with a simple tool. The polarity of the magnet (hereafter referred to as Hall IC magnet) will be automatically discriminated.

This tool is a plastic bar, one end of which is attached with a small magnet (hereafter referred to as plastic bar magnet), as shown in the above illustration. The plastic bar magnet, the polarity of which is known, is secured on the bar with a plastic cover. When the plastic bar magnet is located close to the Hall IC magnet, the Hall IC magnet will be attracted to the plastic bar magnet. The contact side of the Hall IC magnet is different in polarity from that of the plastic bar magnet. As a matter of course, the polarity of the Hall IC magnet will be known then. The Hall IC magnet can be mounted to the appliance in this state. The attraction force of the plastic bar magnet is rather weak due to the plastic cover on it. Therefore, the plastic bar can be separated from the Hall IC magnet with ease after the Hall IC magnet is mounted properly.

- Main characteristics

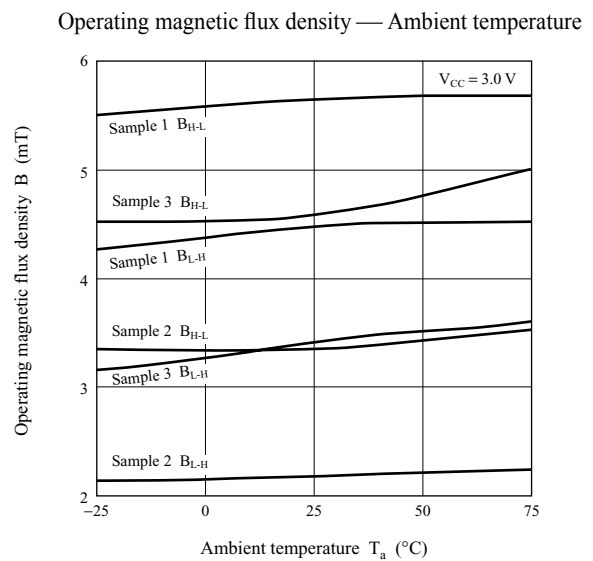
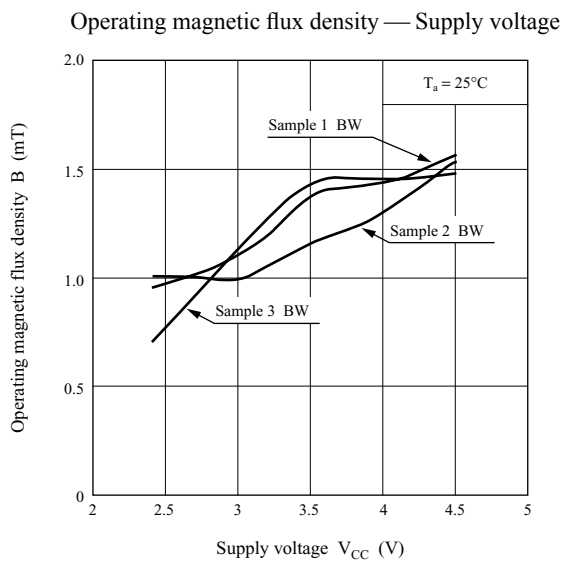

■ Technical Data (continued)

● Main characteristics (continued)

Operating magnetic flux density — Supply voltage

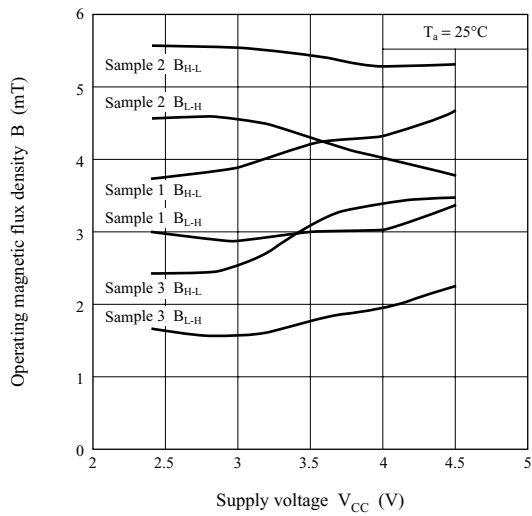

Average consumption current — Supply voltage

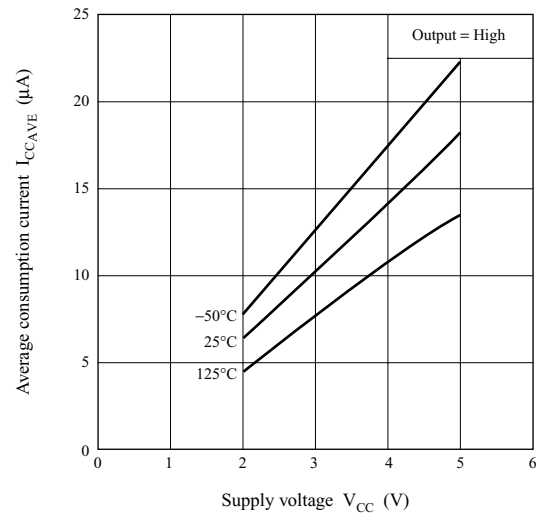

Low-level output voltage — Supply voltage

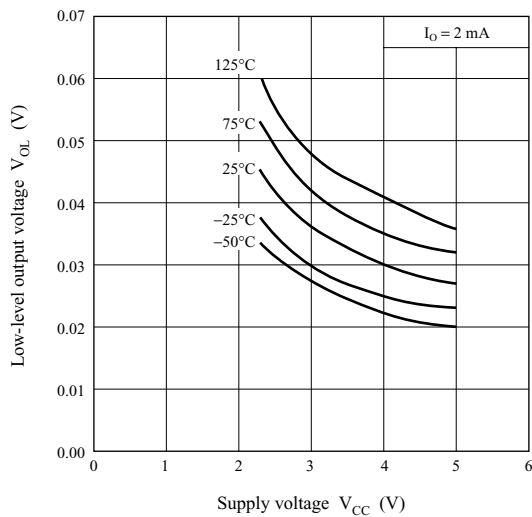

Low-level output voltage — Ambient temperature

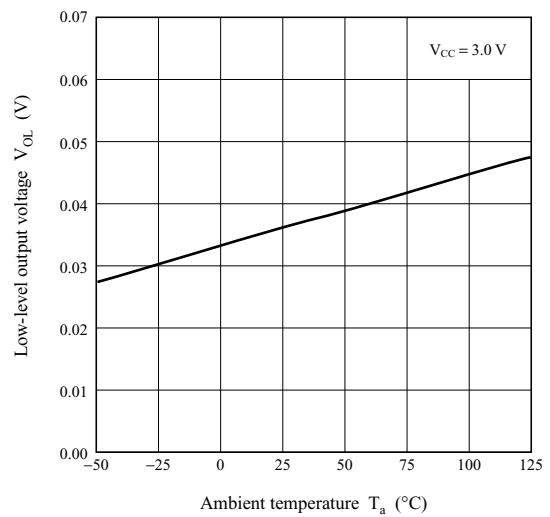

Δ high-level output voltage — Supply voltage

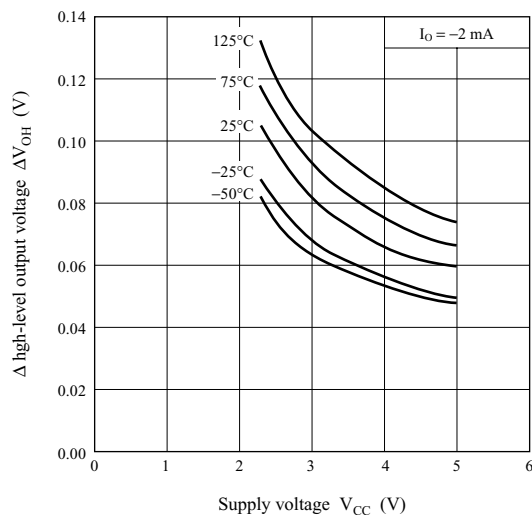

Δ high-level output voltage — Ambient temperature

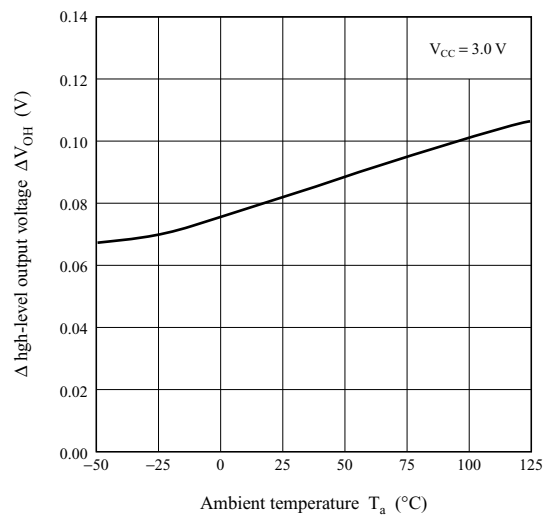

AN48820A

Low current consumption, high sensitivity CMOS Hall IC
Operate by the value of magnetic flux density, regardless of polarity

Overview

The AN48820A is a Hall IC (a magnetic sensor) which has 2 times or more sensitivity and a low current consumption of about one three-hundredth compared with our conventional one.

In this Hall IC, a Hall element, a offset cancel circuit, an amplifier circuit, a sample and hold circuit, a Schmidt circuit, and output stage FET are integrated on a single chip housed in a small package by IC technique.

Features

- Either North nor South magnetic pole can be selected *
- High sensitivity (6 mT max.) due to offset cancel circuit and a new sample and hold circuit
- Small current by using intermittent action
(Average supply current: 3.5 μ A typ.)
- Small package (SMD)
- Open drain output

Applications

- Flip type cellular phone, digital video camera

Block Diagram

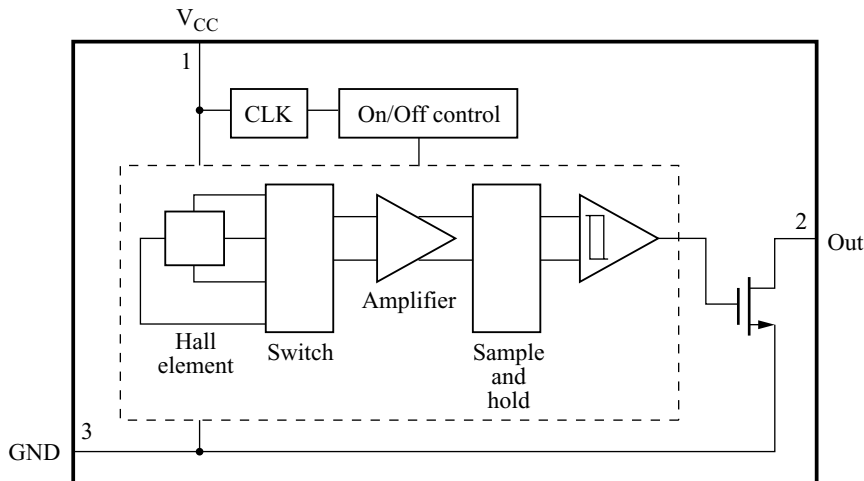

Pin Descriptions

Pin No.	Symbol	Description
1	V _{CC}	Power supply
2	Out	Output
3	GND	Ground

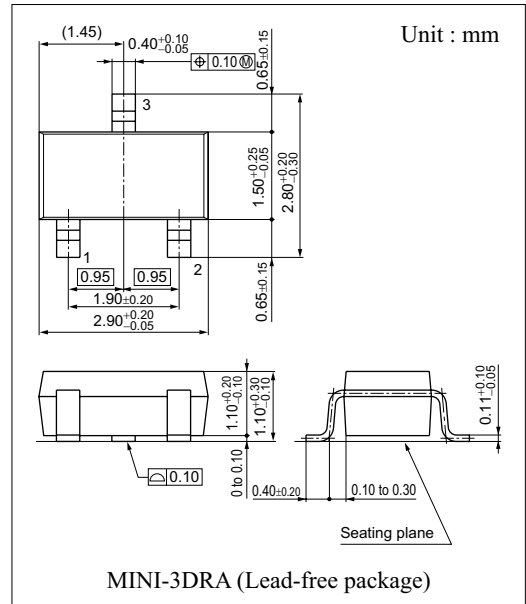

Note) *:

Magnetic flux density

AN48820A output level

Conventional model output level

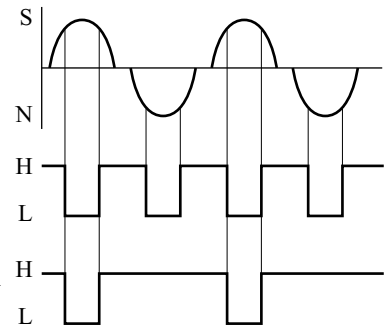

■ Absolute Maximum Ratings

Parameter	Symbol	Rating	Unit
Supply voltage	V_{CC}	5	V
Output voltage	V_{OUT}	5	V
Supply current	I_{CC}	5	mA
Output current	I_{OUT}	15	mA
Power dissipation *1, *2	P_D	60	mW
Operating ambient temperature *1	T_{opr}	-25 to +75	°C
Storage temperature *1	T_{stg}	-55 to +125	°C

Note) *1: Except for the power dissipation, operating ambient temperature and storage temperature, all ratings are for $T_a = 25^\circ\text{C}$.

*2: $T_a = 75^\circ\text{C}$. For the independent IC without a heat sink. Please use within the range of power dissipation, referring to $P_D - T_a$ curve.

■ Recommended Operating Range

Parameter	Symbol	Range	Unit
Supply voltage	V_{CC}	2.5 to 3.5	V

■ Electrical Characteristics $T_a = 25^\circ\text{C} \pm 2^\circ\text{C}$

Parameter	Symbol	Conditions	Min	Typ	Max	Unit
Operating magnetic flux density 1	B_{H-LS}	$V_{CC} = 3\text{ V}$	—	—	6	mT
Operating magnetic flux density 2 *1	B_{H-LN}	$V_{CC} = 3\text{ V}$	-6	—	—	mT
Operating magnetic flux density 3 *2	B_{L-HS}	$V_{CC} = 3\text{ V}$	0.5	—	—	mT
Operating magnetic flux density 4 *2	B_{L-HN}	$V_{CC} = 3\text{ V}$	—	—	-0.5	mT
Output voltage 1	V_{OLS}	$V_{CC} = 3\text{ V}, I_O = 2\text{ mA}, B = 6.0\text{ mT}$	—	0.1	0.3	V
Output voltage 2	V_{OLN}	$V_{CC} = 3\text{ V}, I_O = 2\text{ mA}, B = -6.0\text{ mT}$	—	0.1	0.3	V
Output current 1	I_{OHS}	$V_{CC} = 3\text{ V}, V_O = 3\text{ V}, B = 0.5\text{ mT}$	—	—	10	μA
Output current 2	I_{OHN}	$V_{CC} = 3\text{ V}, V_O = 3\text{ V}, B = -0.5\text{ mT}$	—	—	10	μA
Supply current 1 *3	I_{CCAVE}	$V_{CC} = 3\text{ V}, B = 0.5\text{ mT}$	—	3.5	7.0	μA

Note) *1: Symbol B_{H-LS} , B_{H-LN} stands for the operating magnetic flux density where its output level varies from high to low.

*2: Symbol B_{L-HS} , B_{L-HN} stands for the operating magnetic flux density where its output level varies from low to high.

*3: $I_{CCAVE} = \{I_{CCON} \times t_{ON} + I_{CCOFF} \times t_{OFF}\} / \{t_{ON} + t_{OFF}\}$

• Design reference data

Parameter	Symbol	Conditions	Min	Typ	Max	Unit
Hysteresis width 1	BWS	$V_{CC} = 3\text{ V}$	—	1.2	—	mT
Hysteresis width 2	BWN	$V_{CC} = 3\text{ V}$	—	1.2	—	mT
Supply current 2	I_{CCON}	$V_{CC} = 3\text{ V}, B = 0.5\text{ mT}$	—	1.4	—	mA
Supply current 3	I_{CCOFF}	$V_{CC} = 3\text{ V}, B = 0.5\text{ mT}$	—	2	—	μA
Operating time	t_{ON}	$V_{CC} = 3\text{ V}$	—	20	—	μs
Stop time	t_{OFF}	$V_{CC} = 3\text{ V}$	—	20.5	—	ms

Note) It will operate normally in approximately 41 ms after power on.

Individual Specification

■ Technical Data

- Position of a Hall element (unit in mm)

Distance from a package surface to sensor part: 0.39 mm (reference value)

A Hall element is placed on the shaded part in the figure.

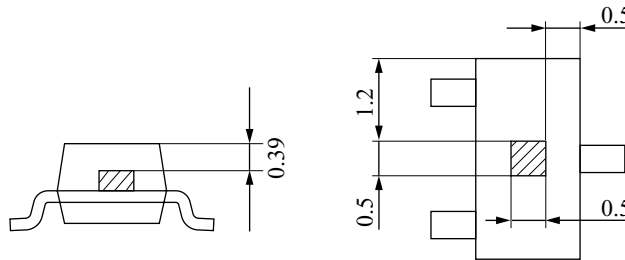

- Magneto-electro conversion characteristics

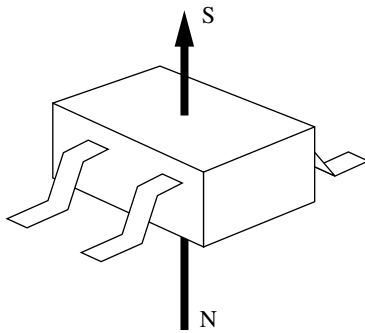

Direction of applied magnetic field

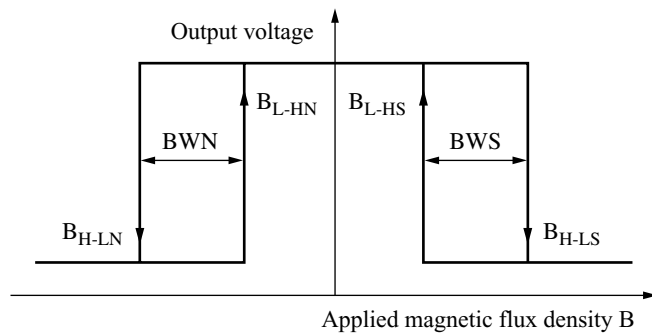

Operating magnetic flux density

- Power dissipation of package MINI-3DRA

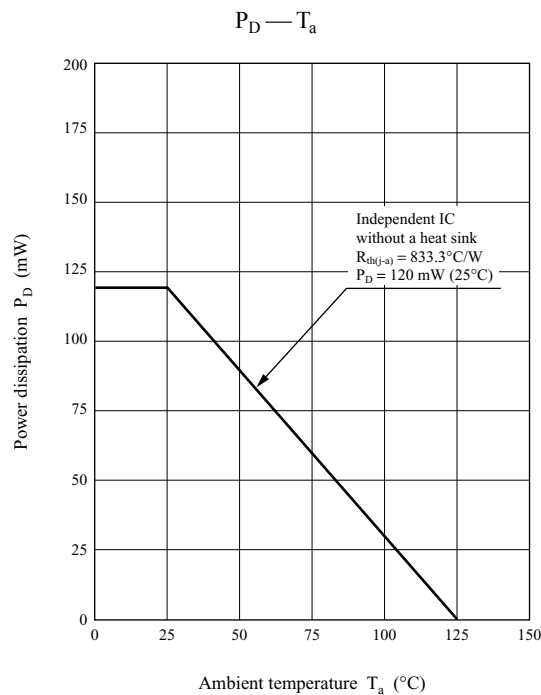

■ Technical Data (continued)

• Main characteristics

Operating magnetic flux density — Supply voltage

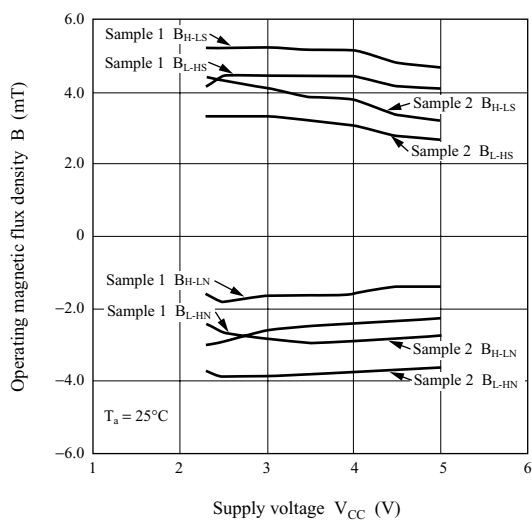

Operating magnetic flux density — Ambient temperature

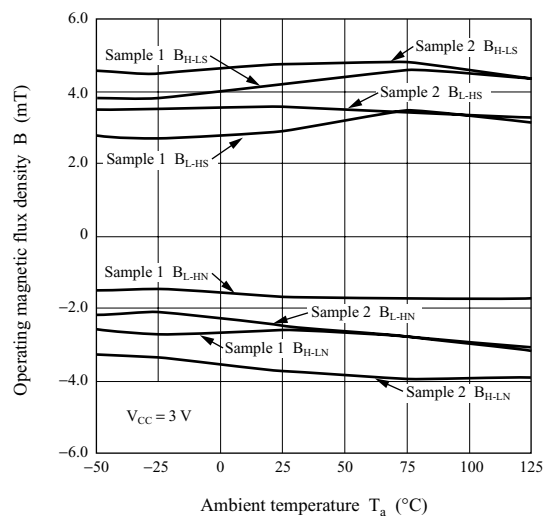

Hysteresis width — Supply voltage

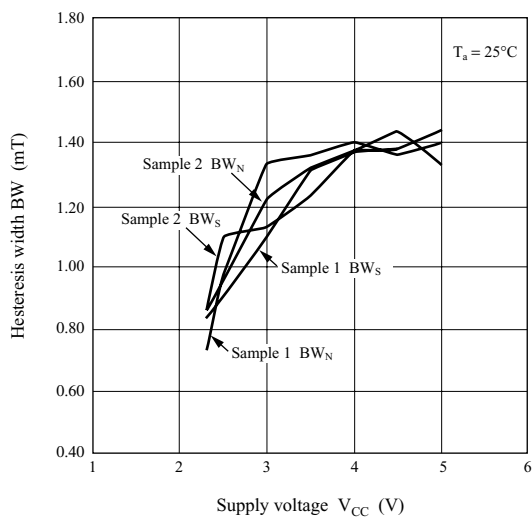

Supply current — Supply voltage

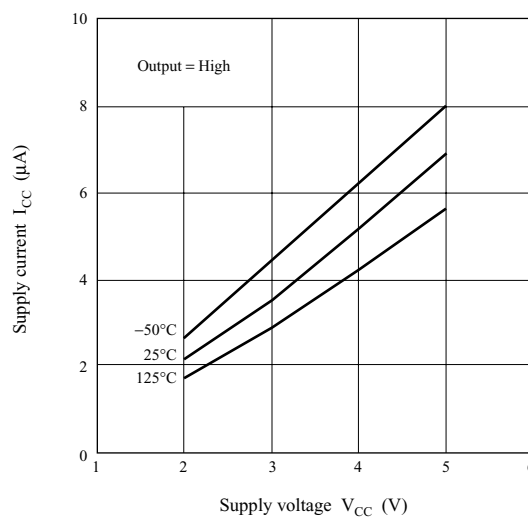

Low-level output voltage — Supply voltage

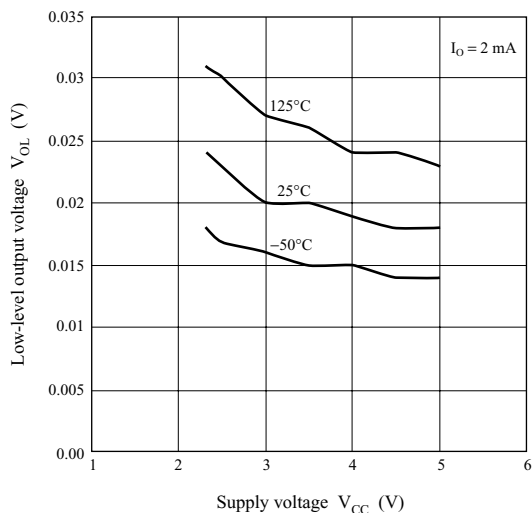

Sampling period — Supply voltage

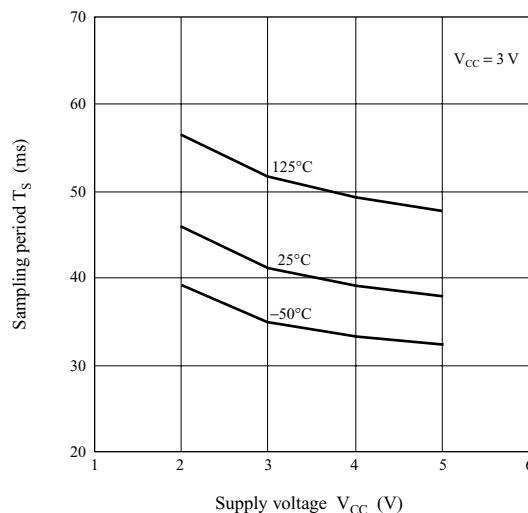

AN48830B

Low current consumption, high sensitivity CMOS Hall IC
Operate by the value of magnetic flux density, regardless of polarity

Overview

The AN48830B is a Hall IC (a magnetic sensor) which has 2 times or more sensitivity and a low current consumption of about one three-hundredth compared with our conventional one.

In this Hall IC, a Hall element, a offset cancel circuit, an amplifier circuit, a sample and hold circuit, a Schmidt circuit, and output stage FET are integrated on a single chip housed in a small package by IC technique.

Features

- Either North nor South magnetic pole can be selected *
- High sensitivity (6 mT max.) due to offset cancel circuit and a new sample and hold circuit
- Small current by using intermittent action
(Average supply current: 3.5 μ A typ.)
- Small package (SMD)
- CMOS inverter output (output form logic)

Applications

- Flip type cellular phone, digital video camera

Block Diagram

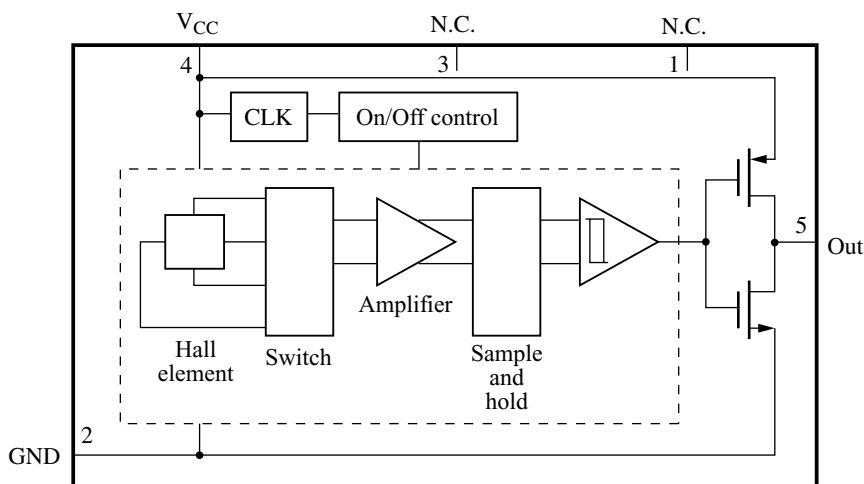

Pin Descriptions

Pin No.	Symbol	Description	Pin No.	Symbol	Description
1	N.C.	—	4	V _{CC}	Power supply
2	GND	Ground	5	Out	Output
3	N.C.	—			

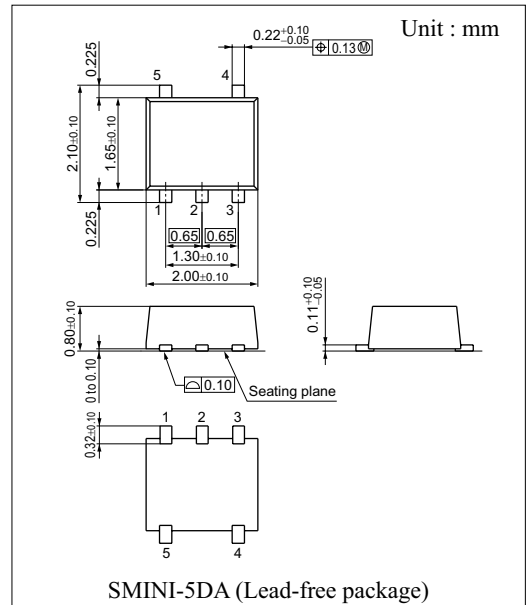

Note) *:

Magnetic flux density

AN48830B output

Conventional model output

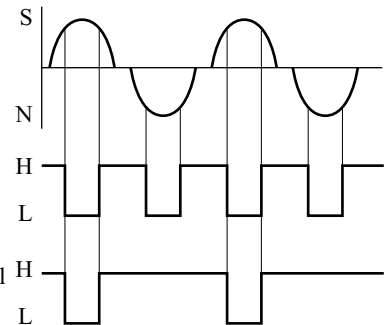

■ Absolute Maximum Ratings

Parameter	Symbol	Rating	Unit
Supply voltage	V_{CC}	5	V
Output voltage	V_{OUT}	5	V
Supply current	I_{CC}	5	mA
Output current	I_{OUT}	15	mA
Power dissipation *1, *2	P_D	60	mW
Operating ambient temperature *1	T_{opr}	-25 to +75	°C
Storage temperature *1	T_{stg}	-55 to +125	°C

Note) *1: Except for the power dissipation, operating ambient temperature and storage temperature, all ratings are for $T_a = 25^\circ\text{C}$.

*2: $T_a = 75^\circ\text{C}$. For the independent IC without a heat sink. Please use within the range of power dissipation, referring to $P_D - T_a$ curve.

■ Recommended Operating Range

Parameter	Symbol	Range	Unit
Supply voltage	V_{CC}	2.5 to 3.5	V

■ Electrical Characteristics $T_a = 25^\circ\text{C} \pm 2^\circ\text{C}$

Parameter	Symbol	Conditions	Min	Typ	Max	Unit
Operating magnetic flux density 1	B_{H-LS}	$V_{CC} = 3\text{ V}$	—	—	6	mT
Operating magnetic flux density 2 *1	B_{H-LN}	$V_{CC} = 3\text{ V}$	-6	—	—	mT
Operating magnetic flux density 3 *2	B_{L-HS}	$V_{CC} = 3\text{ V}$	0.5	—	—	mT
Operating magnetic flux density 4 *2	B_{L-HN}	$V_{CC} = 3\text{ V}$	—	—	-0.5	mT
Output voltage 1	V_{OLS}	$V_{CC} = 3\text{ V}, I_O = 2\text{ mA}, B = 6.0\text{ mT}$	—	0.1	0.3	V
Output voltage 2	V_{OLN}	$V_{CC} = 3\text{ V}, I_O = 2\text{ mA}, B = -6.0\text{ mT}$	—	0.1	0.3	V
Output voltage 3	V_{OHS}	$V_{CC} = 3\text{ V}, I_O = -2\text{ mA}, B = 0.5\text{ mT}$	2.7	2.9	—	V
Output voltage 4	V_{OHN}	$V_{CC} = 3\text{ V}, I_O = -2\text{ mA}, B = -0.5\text{ mT}$	2.7	2.9	—	V
Supply current 1 *3	$I_{CC_{AVE}}$	$V_{CC} = 3\text{ V}$	—	3.5	7.0	μA

Note) *1: Symbol B_{H-LS} , B_{H-LN} stands for the operating magnetic flux density where its output level varies from high to low.

*2: Symbol B_{L-HS} , B_{L-HN} stands for the operating magnetic flux density where its output level varies from low to high.

*3: $I_{CC_{AVE}} = \{I_{CC_{ON}} \times t_{ON} + I_{CC_{OFF}} \times t_{OFF}\} / \{t_{ON} + t_{OFF}\}$

• Design reference data

Parameter	Symbol	Conditions	Min	Typ	Max	Unit
Hysteresis width 1	BWS	$V_{CC} = 3\text{ V}$	—	1.2	—	mT
Hysteresis width 2	BWN	$V_{CC} = 3\text{ V}$	—	1.2	—	mT
Supply current 2	$I_{CC_{ON}}$	$V_{CC} = 3\text{ V}$	—	1.4	—	mA
Supply current 3	$I_{CC_{OFF}}$	$V_{CC} = 3\text{ V}$	—	2	—	μA
Operating time	t_{ON}	$V_{CC} = 3\text{ V}$	—	20	—	μs
Stop time	t_{OFF}	$V_{CC} = 3\text{ V}$	—	20.5	—	ms

Note) It will operate normally in approximately 41 ms after power on.

Individual Specification

■ Technical Data

- Position of a Hall element (unit in mm)

Distance from a package surface to sensor part: 0.39 mm (reference value)

A Hall element is placed on the shaded part in the figure.

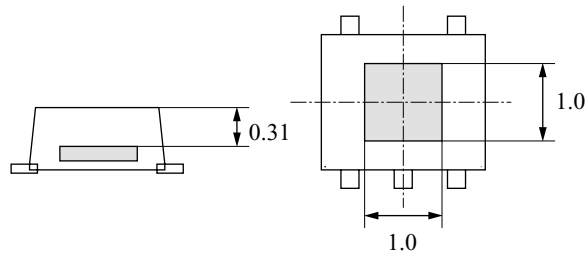

- Magneto-electro conversion characteristics

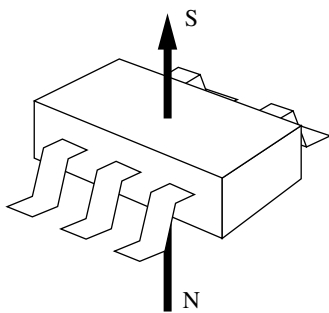

Direction of applied magnetic field

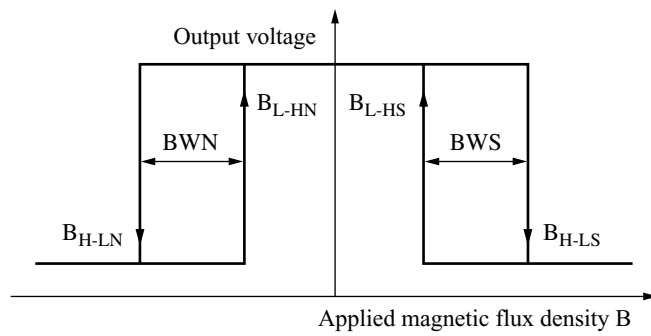

Operating magnetic flux density

- Power dissipation of package MINI-5DA

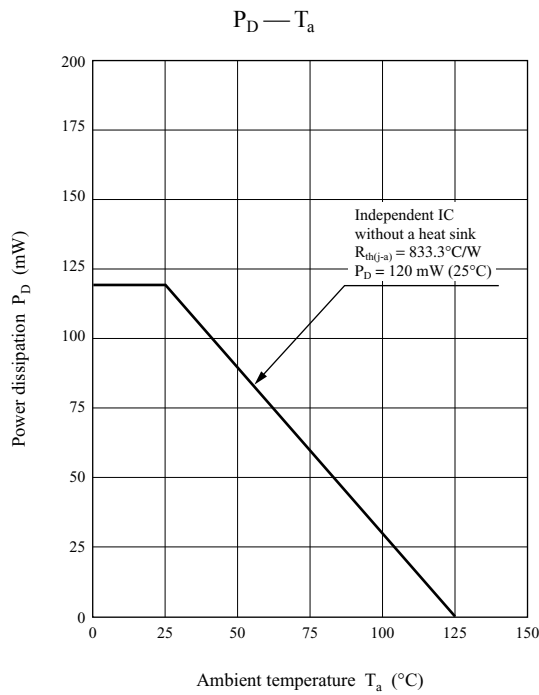

■ Technical Data (continued)

• Main characteristics

Operating magnetic flux density — Supply voltage

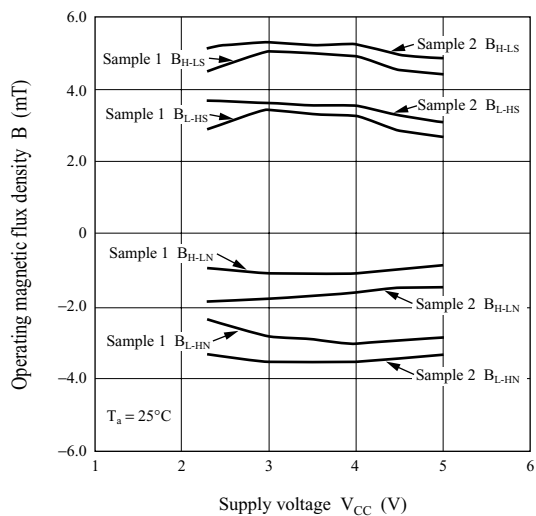

Operating magnetic flux density — Ambient temperature

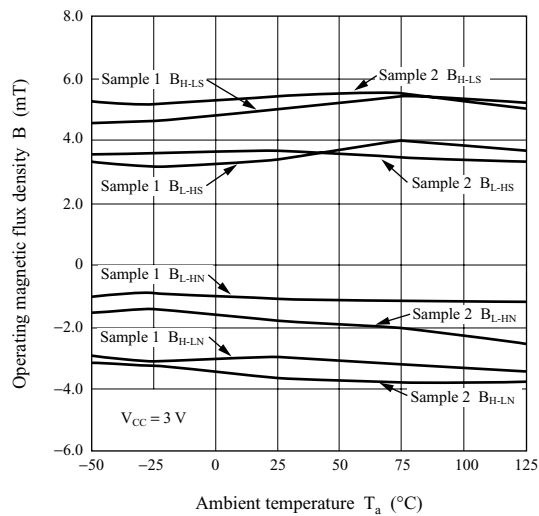

Hysteresis width — Supply voltage

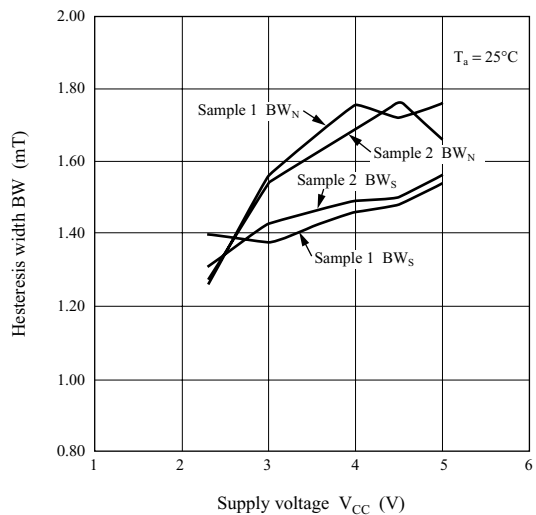

Supply current — Supply voltage

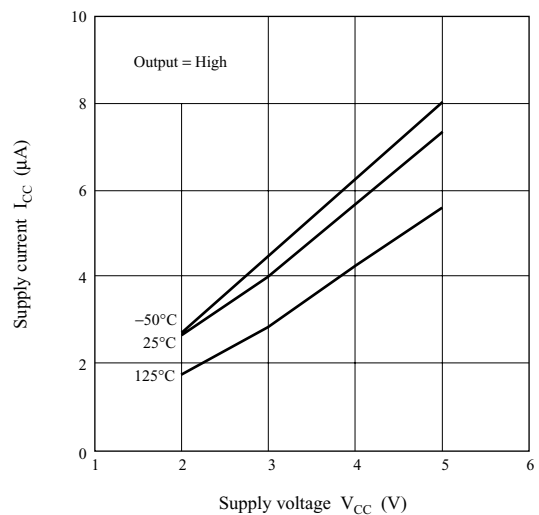

Low-level output voltage — Supply voltage

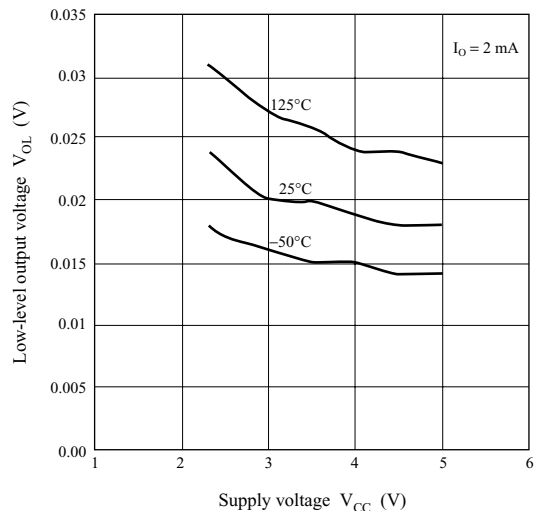

Δ high-level output voltage — Supply voltage

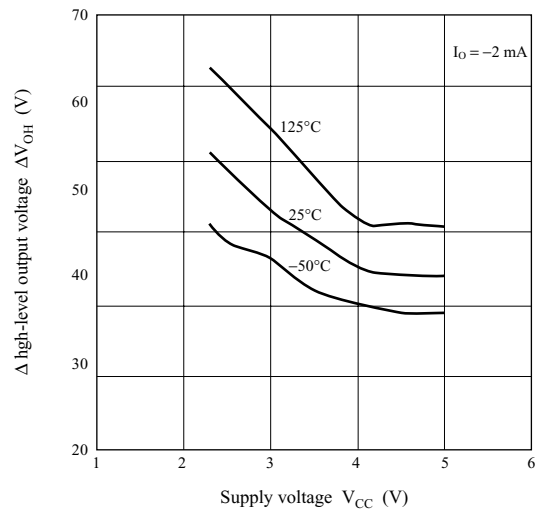

AN48840B

Low current consumption, high sensitivity CMOS Hall IC
 Alternating magnetic field operation (For low-speed rotation detection)

Overview

The AN48840B is a Hall IC (a magnetic sensor) which has 2 times or more sensitivity and a low current consumption of about one fiftieth compared with our conventional one.

In this Hall IC, a Hall element, a offset cancel circuit, an amplifier circuit, a sample and hold circuit, a Schmidt circuit, and output stage FET are integrated on a single chip housed in a small package by IC technique.

Features

- High sensitivity (6 mT max.) due to offset cancel circuit and a new sample and hold circuit
- Small current by using intermittent action
 (Average supply current: 56 μ A typ., Sampling period: 670 μ s typ.)
- Small package (SMD)
- CMOS inverter output (logic output form)

Applications

- Functional operation key, Mouse,
 Appliances for low-speed rotation detection

Block Diagram

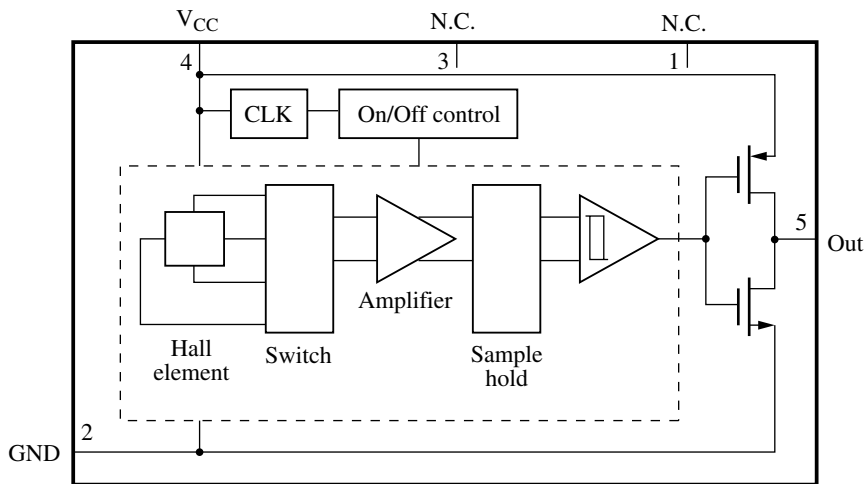

Pin Descriptions

Pin No.	Symbol	Description	Pin No.	Symbol	Description
1	N.C.	—	4	V _{CC}	Power supply
2	GND	Ground	5	Out	Output
3	N.C.	—			

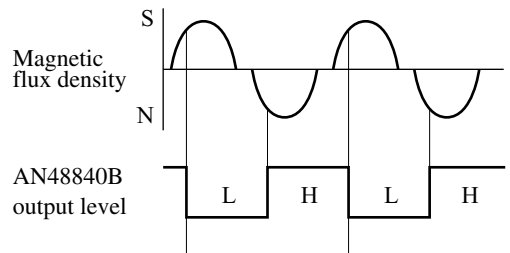
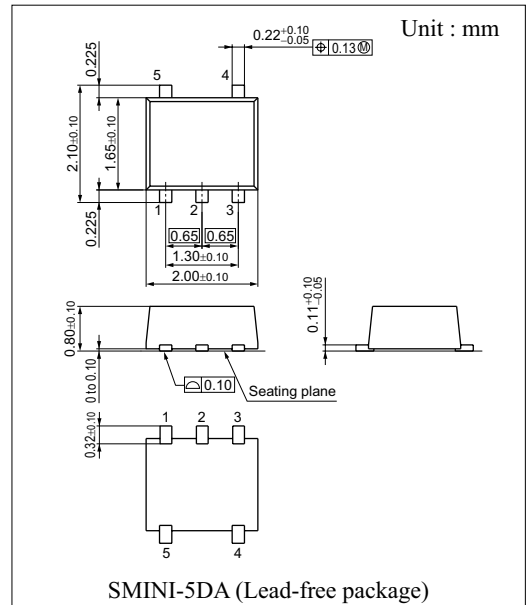

■ Absolute Maximum Ratings

Parameter	Symbol	Rating	Unit
Supply voltage	V_{CC}	5	V
Output voltage	V_{OUT}	5	V
Supply current	I_{CC}	5	mA
Output current	I_{OUT}	15	mA
Power dissipation *1,*2	P_D	60	mW
Operating ambient temperature *1	T_{opr}	-25 to +75	°C
Storage temperature *1	T_{stg}	-55 to +125	°C

Note) *1: Except for the power dissipation, operating ambient temperature and storage temperature, all ratings are for $T_a = 25^\circ\text{C}$.

*2: $T_a = 75^\circ\text{C}$. For the independent IC without a heat sink. Please use within the range of power dissipation, referring to $P_D - T_a$ curve.

■ Recommended Operating Range

Parameter	Symbol	Range	Unit
Supply voltage	V_{CC}	2.5 to 3.5	V

■ Electrical Characteristics $T_a = 25^\circ\text{C} \pm 2^\circ\text{C}$

Parameter	Symbol	Conditions	Min	Typ	Max	Unit
Operating magnetic flux density 1 *1	B_{HL}	$V_{CC} = 3\text{ V}, V_{CC} = 2.5\text{ V}$	0.5	—	6	mT
Operating magnetic flux density 2 *2	B_{LH}	$V_{CC} = 3\text{ V}, V_{CC} = 2.5\text{ V}$	-6	—	-0.5	mT
Output voltage 1	V_{OL1}	$V_{CC} = 3\text{ V}, I_O = 2\text{ mA}, B = 6.0\text{ mT}$	—	0.1	0.3	V
Output voltage 1	V_{OL2}	$V_{CC} = 2.5\text{ V}, I_O = 2\text{ mA}, B = 6.0\text{ mT}$	—	0.1	0.3	V
Output voltage 2	V_{OH1}	$V_{CC} = 3\text{ V}, I_O = -2\text{ mA}, B = -6.0\text{ mT}$	2.7	2.9	—	V
Output voltage 2	V_{OH2}	$V_{CC} = 2.5\text{ V}, I_O = -2\text{ mA}, B = -6.0\text{ mT}$	2.7	2.9	—	V
Supply current 1 *3	I_{CCAVE}	$V_{CC} = 3\text{ V}$	—	56.0	85.0	μA
Supply current 2 *3	I_{CC2AVE}	$V_{CC} = 2.5\text{ V}$	—	48.0	72.0	μA
Intermittent action time	T_{sam}	$V_{CC} = 3\text{ V}$	490	670	850	μS
Intermittent action time 2	T_{sam2}	$V_{CC} = 2.5\text{ V}$	513	710	890	μS

Note) *1: Symbol B_{H-LS} , B_{H-LN} stands for the operating magnetic flux density where its output level varies from high to low.

*2: Symbol B_{L-HS} , B_{L-HN} stands for the operating magnetic flux density where its output level varies from low to high.

*3: $I_{CCAVE} = \{I_{CCON} \times t_{ON} + I_{CCOFF} \times t_{OFF}\} / \{t_{ON} + t_{OFF}\}$

• Design reference data

Parameter	Symbol	Conditions	Min	Typ	Max	Unit
Hysteresis width	BW	$V_{CC} = 3\text{ V}$	—	7	—	mT
Supply current 3	I_{CCON}	$V_{CC} = 3\text{ V}$	—	1.4	2.1	mA
Supply current 4	I_{CCOFF}	$V_{CC} = 3\text{ V}$	—	2.5	—	μA
Supply current 5	I_{CC2ON}	$V_{CC} = 2.5\text{ V}$	—	1.12	1.68	mA
Supply current 6	I_{CC2OFF}	$V_{CC} = 2.5\text{ V}$	—	2.2	—	μA
Operating time	t_{ON}	$T_a = -25^\circ\text{C}$ to 75°C , $V_{CC} = 3\text{ V}$	10	26	42	μS
Stop time	t_{OFF}	$T_a = -25^\circ\text{C}$ to 75°C , $V_{CC} = 3\text{ V}$	258	644	1 030	μS
Operating time 2	t_{2ON}	$T_a = -25^\circ\text{C}$ to 75°C , $V_{CC} = 2.5\text{ V}$	11	27	43	μS
Stop time 2	t_{2OFF}	$T_a = -25^\circ\text{C}$ to 75°C , $V_{CC} = 2.5\text{ V}$	270	674	1 078	μS

Note) It will operate normally in approximately 0.67 ms after power on.

Individual Specification

■ Technical Data

- Position of a Hall element (unit in mm)

Distance from a package surface to sensor part: 0.31 mm (reference value)

A Hall element is placed on the shaded part in the figure.

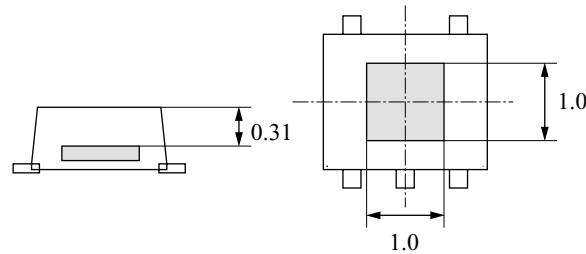

- Magneto-electro conversion characteristics

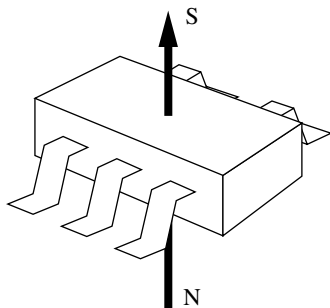

Direction of applied magnetic field

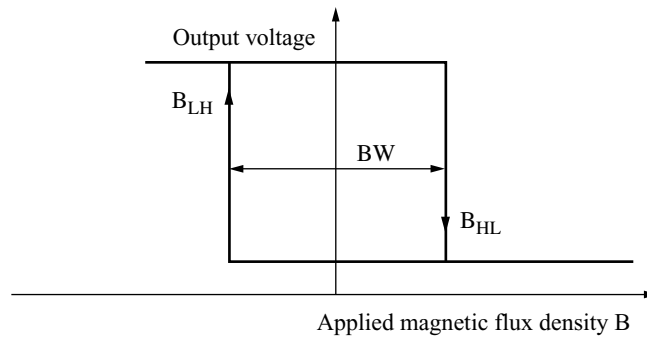

Operating magnetic flux density

- Power dissipation of package SMINI-5DA

$$P_D \text{ --- } T_a$$

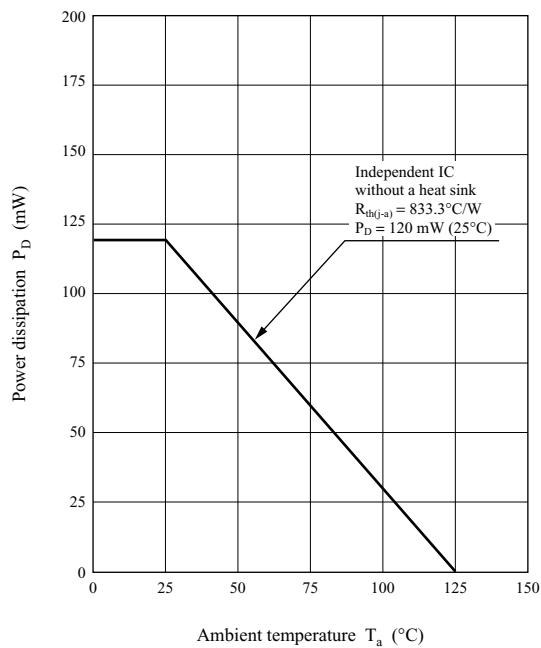

- Main characteristics

Operating magnetic flux density — Supply voltage

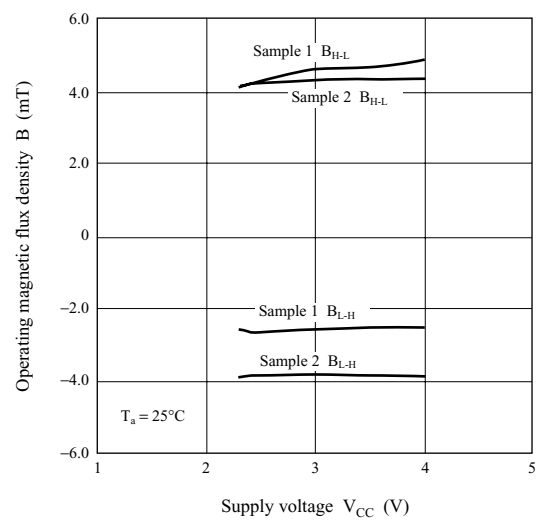

■ Technical Data (continued)

● Main characteristics (continued)

Operating magnetic flux density — Ambient temperature

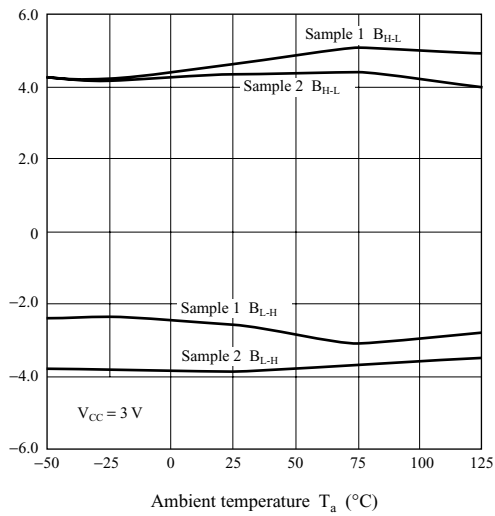

Hysteresis width — Supply voltage

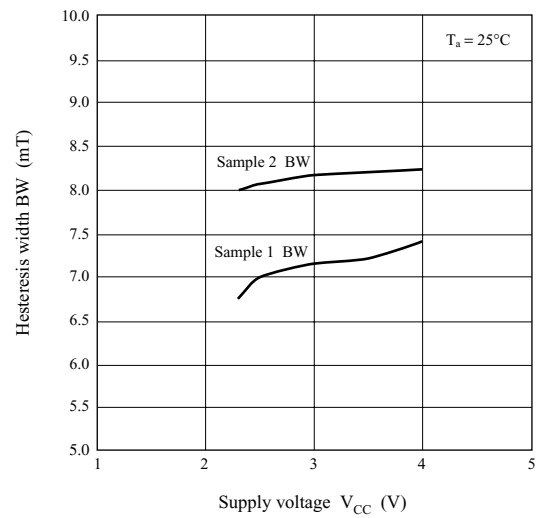

Supply current — Supply voltage

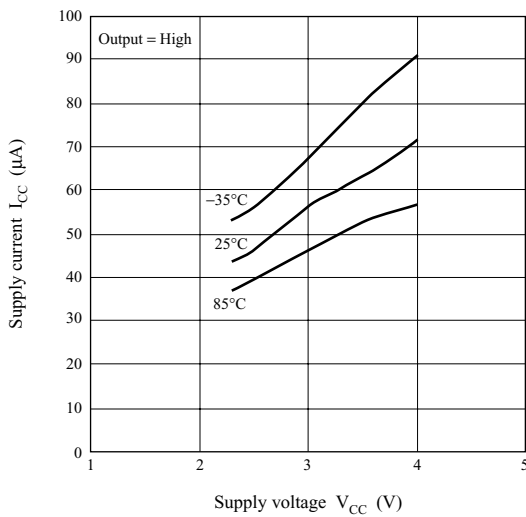

Low-level output voltage — Supply voltage

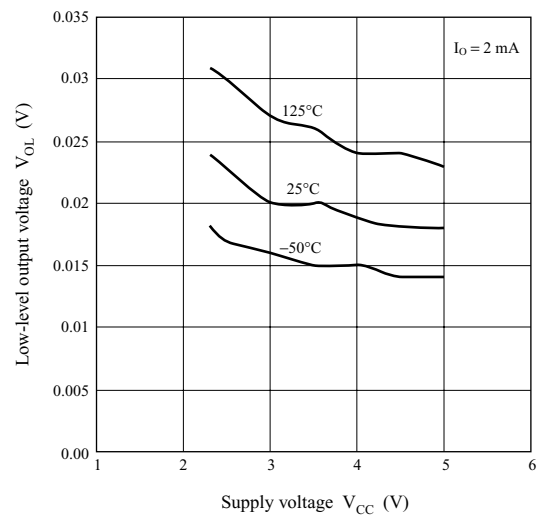

Δ high-level output voltage — Supply voltage

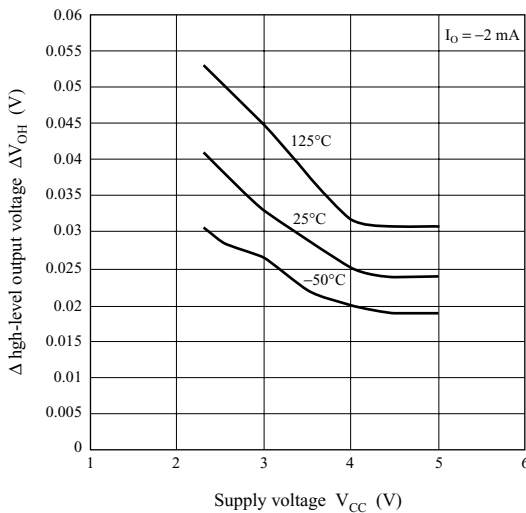

Sampling period — Supply voltage

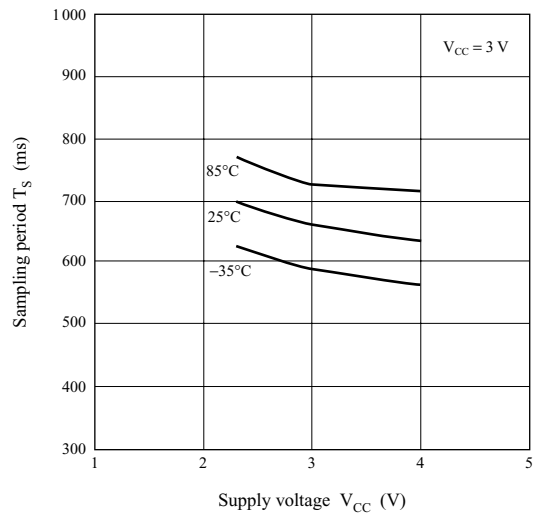

Inquiries

If you have questions regarding technical information on this documentation,
please contact us by e-mail at:

semi-ana@mecse.mec.mei.co.jp

User Support Team

Semiconductor Company, Matsushita Electric Industrial Co., Ltd.

0520041C_A

Pub. No.A00009EE

Hall iC Series Application Notes

May 10, 2004 5th Edition

Issued by

Semiconductor Company,
Matsushita Electric Industrial Co., Ltd.

© Matsushita Electric Industrial Co., Ltd. 2004

SALES OFFICES

□ NORTH AMERICA

● U.S.A. Sales Office:

Panasonic Industrial Company □ [PIC]

● New Jersey Office:

2 Panasonic Way Secaucus, New Jersey 07094, U.S.A.
Tel:1-201-348-5257 Fax:1-201-392-4652

● Chicago Office:

1707 N. Randall Road Elgin, Illinois 60123-7847, U.S.A.
Tel:1-847-468-5720 Fax:1-847-468-5725

● San Jose Office:

2033 Gateway Place, Suite 200, San Jose, California 95110, U.S.A.

Tel:1-408-487-9510 Fax:1-408-436-8037

● Atlanta Office:

1225 Northbrook Parkway Suite 1-151 Suwanee, Georgia 30024, U.S.A.

Tel:1-770-338-6953 Fax:1-770-338-6849

● San Diego Office:

9444 Balboa Avenue, Suite 185, San Diego, California 92123, U.S.A.

□Tel:1-858-503-2910 Fax:1-858-715-5545

● Canada Sales Office:

Panasonic Canada Inc. □ [PCI]

5770 Ambler Drive 27 Mississauga, Ontario L4W 2T3, Canada

Tel:1-905-238-2243 Fax:1-905-238-2414

□ LATIN AMERICA

● Mexico Sales Office:

Panasonic de Mexico, S.A. de C.V. □ [PANAMEX]

Amores 1120 Col. Del Valle Delegacion Benito Juarez C.P. 03100 Mexico, D.F. Mexico

Tel:52-5-488-1000 Fax:52-5-488-1073

● Guadalajara Office:

Sucursal Guadajarara Av. Lazaro Cardenas 2305 Local G-102 Plaza Comercial Abastos; Col. Las Torres Guadalajara, Jal. 44920, Mexico

Tel:52-3-671-1205 Fax:52-3-671-1256

● Brazil Sales Office:

Panasonic do Brasil Ltda. □ [PANABRAS]

Caixa Postal 1641, Sao Jose dos Campos, Estado de Sao Paulo, Brasil

Tel:55-12-3935-9000 Fax:55-12-3931-3789

□ EUROPE

● Europe Sales Office:

Panasonic Industrial Europe GmbH □ [PIE]

● Germany Sales Office:

Hans-Pinsel-Strasse 2 85540 Haar, Germany

Tel:49-89-46159-119 Fax:49-89-46159-195

□ ASIA

● Singapore Sales Office:

Panasonic Semiconductor Sales Asia □ [PSCSA]

300 Beach Road, #16-01, the Concourse, Singapore 199555, the Republic of Singapore

Tel:65-6390-3688 Fax:65-6390-3689

● Malaysia Sales Office:

Panasonic Industrial Company (M) Sdn. Bhd. □ [PICM]

● Head Office:

15th Floor, Menara IGB, Mid Valley City, Lingkaran Syed Putra, 59200 Kuala Lumpur, Malaysia

Tel:60-3-2297-6888 Fax:60-6-2284-6898

● Penang Office:

Suite 20-07, 20th Floor, MWE Plaza, No.8, Lebuhr Farquhar, 10200 Penang, Malaysia

Tel: 60-4-201-5113 Fax:60-4-261-9989

● Johore Sales Office:

Menara Pelangi, Suite 8.3A, Level 8, No.2, Jalan Kuning, Taman Pelangi, 80400 Johor Bahru, Johor, Malaysia

Tel:60-7-331-3822 Fax:60-7-355-3996

● Thailand Sales Office:

Panasonic Industrial (Thailand) Ltd. □ [PICT]

252-133 Muang Thai-Phatra Complex Building, 31st Floor Rachadaphisek Road, Huaykwang, Bangkok 10320, Thailand

Tel:66-2-693-3400 to 3421 Fax:66-2-693-3422 to 3427

● Philippines Sales Office:

Panasonic Industrial Sales Philippines □ [PISP]

102 Laguna Boulevard, Bo. Don Jose Laguna Technopark, Santa Rosa, Laguna 4026, the Philippines

Tel:63-2-520-8615 Fax:63-2-520-8629

● China Sales Office:

Panasonic Industrial (Shanghai) Co., Ltd. □ [PI(SH)]

Floor 12, China Insurance Building, 166 East Road Lujiazui, Pudong New District, Shanghai 200120, China

Tel:86-21-6841-9642 Fax:86-21-6841-9631

● Panasonic Industrial (Tianjin) Co., Ltd. [PI(TJ)]

Room No.1001, Tianjin International Building 75, Nanjin Road, Tianjin 300050, China

Tel:86-22-2313-9771 Fax:86-22-2313-9770

● Panasonic SH Industrial Sales (Shenzhen) Co., Ltd. [PSI(SZ)]

● Shum Yip Centre Office:

25F, Shum Yip Centre, #5045, East Shennan Road, Shenzhen, China

Tel:86-755-8211-0888 Fax:86-755-8211-0970

● Panasonic Shun Hing Industrial Sales (Hong Kong) Co., Ltd. [PSI(HK)]

11th Floor, Great Eagle Center 23 Harbour Road, Wanchai, Hong Kong

Tel:852-2529-7322 Fax:852-2865-3697

● Taiwan Sales Office:

Panasonic Industrial Sales (Taiwan) Co., Ltd. □ [PIST]

● Head Office:

6F, 550, Sec. 4, Chung Hsiao E. RD. Taipei 110, Taiwan

Tel:886-2-2757-1900 Fax:886-2-2757-1906

● Kaohsiung Office:

6th Floor, Hsin Kong Bldg. No.251, Chi Hsien 1st Road, Kaohsiung 800, Taiwan

Tel:886-7-346-3815 Fax:886-7-236-8362

● Korea Sales Office:

Panasonic Industrial Korea Co., Ltd. □ [PIKL]

Kukje Center Bldg. 11th Floor, 191 Hangangro 2ga, Youngsan-ku, Seoul 140-702, Korea

Tel:82-2-795-9600 Fax:82-2-795-1542

Semiconductor Company, Matsushita Electric Industrial Co., Ltd.

Nagaokakyo, Kyoto 617-8520, Japan

Tel:075-951-8151

<http://panasonic.co.jp/semicon/e-index.html>