

NOTE

All numerical values are in metric units. Dimensions are in millimeters. Unless otherwise specified, dimensions have a tolerance of ± 0.13 and angles have a tolerance of $\pm 2^\circ$. Figures and illustrations are for identification only and are not drawn to scale.

1. INTRODUCTION

This specification covers the AMP* CHAMP .050 Series Low Profile Docking Connectors. These connectors are available in 72, 160, 200, and 240 positions.

CHAMP .050 Series Low Profile Docking Connectors are available in right-angle and vertical plug assemblies (with standard and inverted shell orientations) and right-angle receptacle assemblies, with guide hardware pre-installed or shipped separately to allow rear panel mounting. These connectors are designed with 1.27 mm [.050 in.] spacing. The connectors contain retention legs to provide additional stability and are designed for manual placement on a printed circuit (pc) board.

When corresponding with AMP personnel, use the terminology provided on this specification to help facilitate your inquiry for information. Basic terms and features of components are provided in Figure 1.

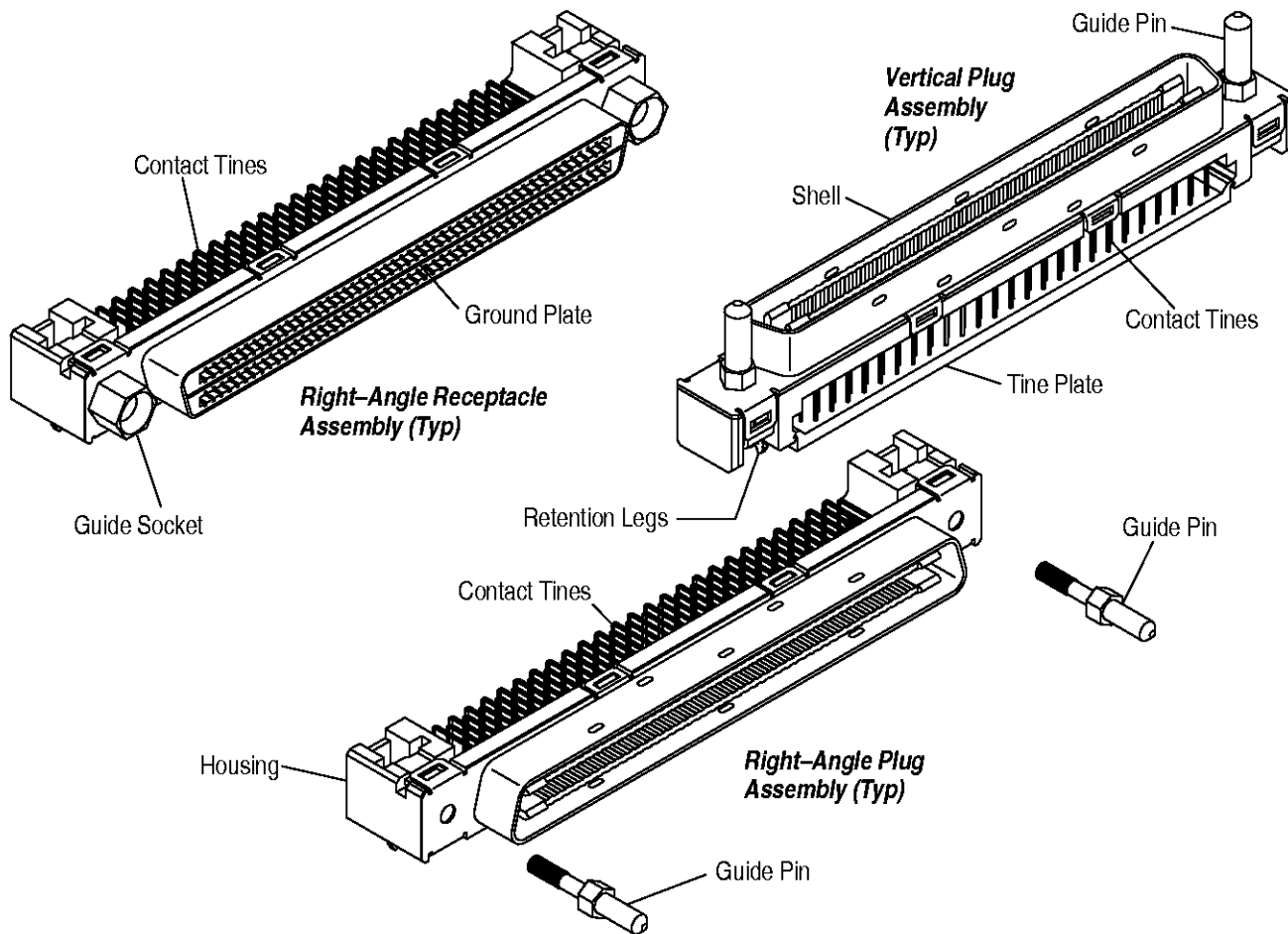

Figure 1

2. REFERENCE MATERIAL

2.1. Revision Summary

Per EC 0990-0038-98

- Initial release of application specification

2.2. Customer Assistance

Reference Part Number 787851 and Product Code 1997 are representative numbers of AMP CHAMP .050 Series Low Profile Docking Connectors. Use of these numbers will identify the product line and expedite your inquiries through an AMP service network established to help you obtain product and tooling information. Such information can be obtained through a local AMP Representative (Field Sales Engineer, Field Applications Engineer, etc) or, after purchase, by calling the Tooling Assistance Center or the AMP FAX/Product Information Center number at the bottom of page 1.

2.3. Drawings

AMP Customer Drawings for specific products are available from the service network. The information contained in Customer Drawings takes priority if there is a conflict with this specification or with any technical documentation supplied by AMP Incorporated.

2.4. Bulletins

AMP Corporate Bulletin 401-52 is available from the service network. This bulletin provides information on various flux types and characteristics along with the commercial designation and flux removal procedures. A checklist is attached to the bulletin as a guide for information on soldering problems.

2.5. Specifications

AMP Product Specifications 108-1752 and 108-5386 provide performance test information and quality requirements for AMP CHAMP .050 Series Low Profile Docking Connectors.

2.6. Instructional Material

Refer to AMP Instruction Sheet 408-6927 for information on pc board support fixtures.

3. REQUIREMENTS**3.1. Storage****A. Ultraviolet Light**

Prolonged exposure to ultraviolet light may deteriorate the chemical composition used in the connector housings.

B. Shelf Life

The connectors should remain in the shipping containers until ready for use to prevent deformation to the connectors. The connectors should be used on a first in, first out basis to avoid storage contamination that could adversely affect signal transmissions.

C. Chemical Exposure

Do not store the connectors near any chemicals listed below as they may cause stress corrosion cracking in the contacts.

Alkalies	Ammonia	Citrates	Phosphates	Citrates	Sulfur Compounds
Amines	Carbonates	Nitrites	Sulfur	Nitrites	Tartrates

3.2. Connector Size

The CHAMP .050 Series Low Profile Docking Connector sizes are available in the following positions:

- Right-Angle Receptacle – 72, 160, 200, and 240 positions
- Right-Angle Plug – 72, 160, 200, and 240 positions
- Vertical Plug – 72, 200, and 240 positions

3.3. Printed Circuit Boards**A. Material and Thickness**

The pc board material shall be glass epoxy (FR-4, G-10). CHAMP .050 Series Low Profile Docking Connectors are designed for pc boards of 1.6 nominal thickness. See Figure 2. Contact the Product Information Center number listed at the bottom of page 1 for suitability of other board materials and thicknesses.

B. Tolerance

The maximum bow of the pc board shall be 0.05 over the length of the connector.

C. Layout

The mounting and contact holes in the pc board must be precisely located to ensure proper placement and optimum performance of the connector. The "X" and "Y" symbols on the pc board layout represent customer established datums. They are the origin for the basic dimension (XXX and YYY datum), the point from which ALL hole positions must be located. Design the pc board using the dimensions provided in Figure 2.

NOTE The layout dimensions apply to the component side of the pc board.

POSITION	DIMENSION				
	A	B	C	D	G
72	21.59	25.49	38.66	—	—
160	49.53	53.43	66.60	—	27.50
240	74.93	78.83	92.00	92.00	27.50

5-Row Footprint (72-, 160-, and 240-Position for Right-Angle Receptacles)

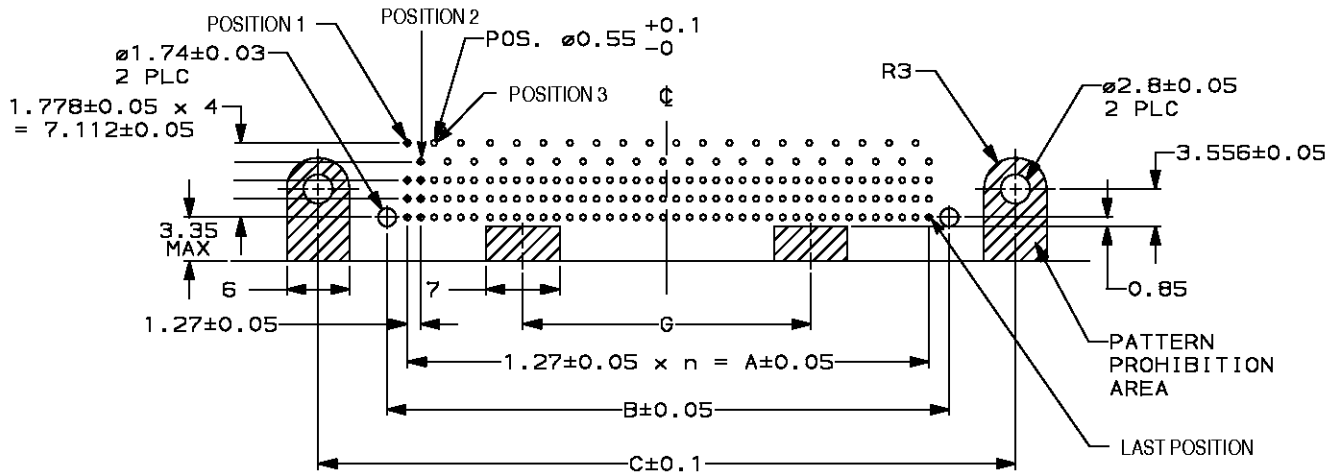

5-Row Footprint (72-, and 160-Position for Right-Angle Plugs)

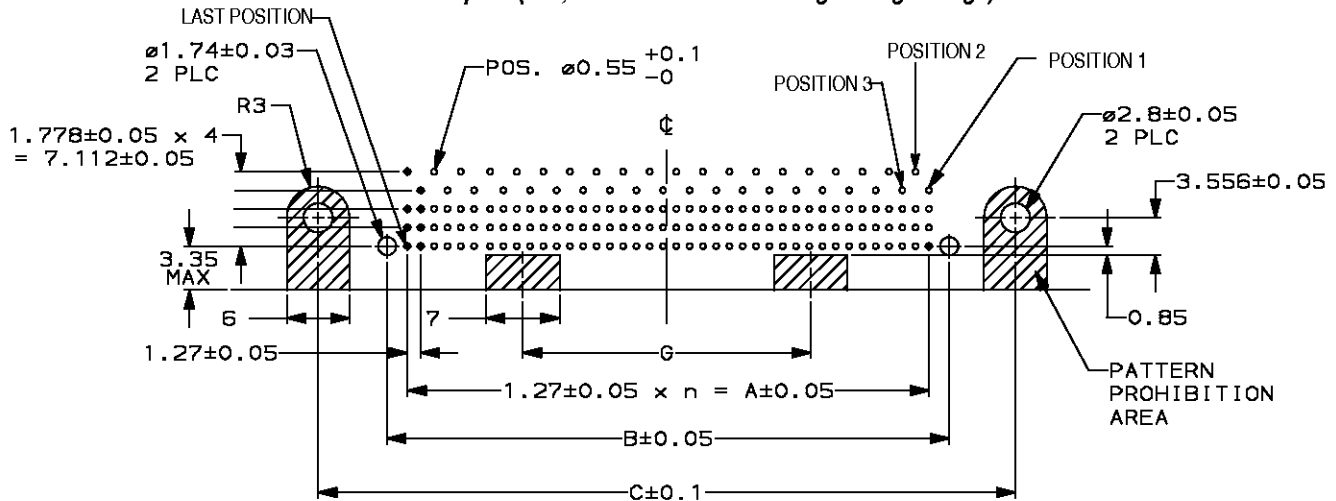
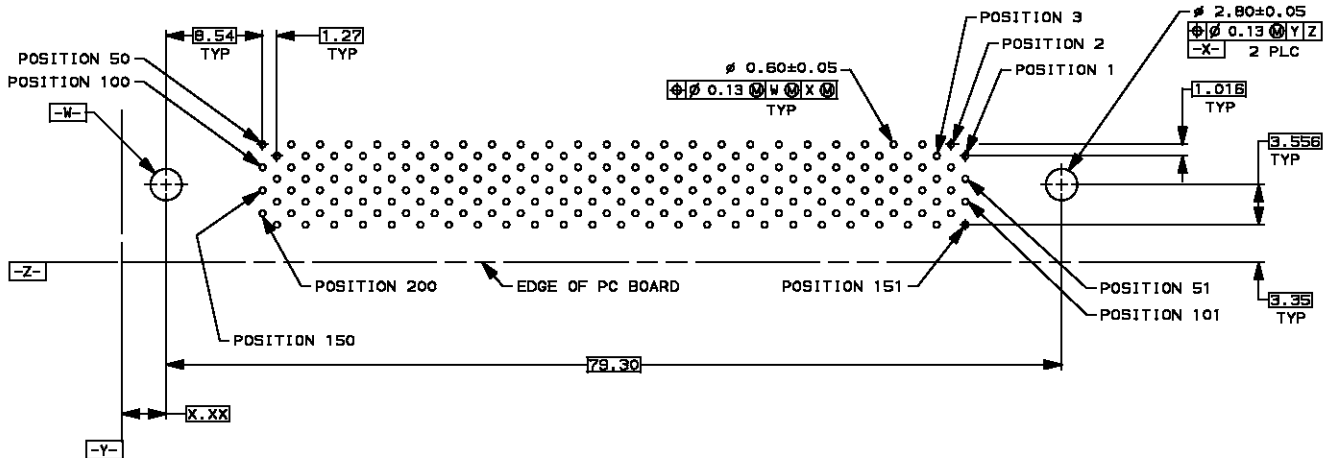
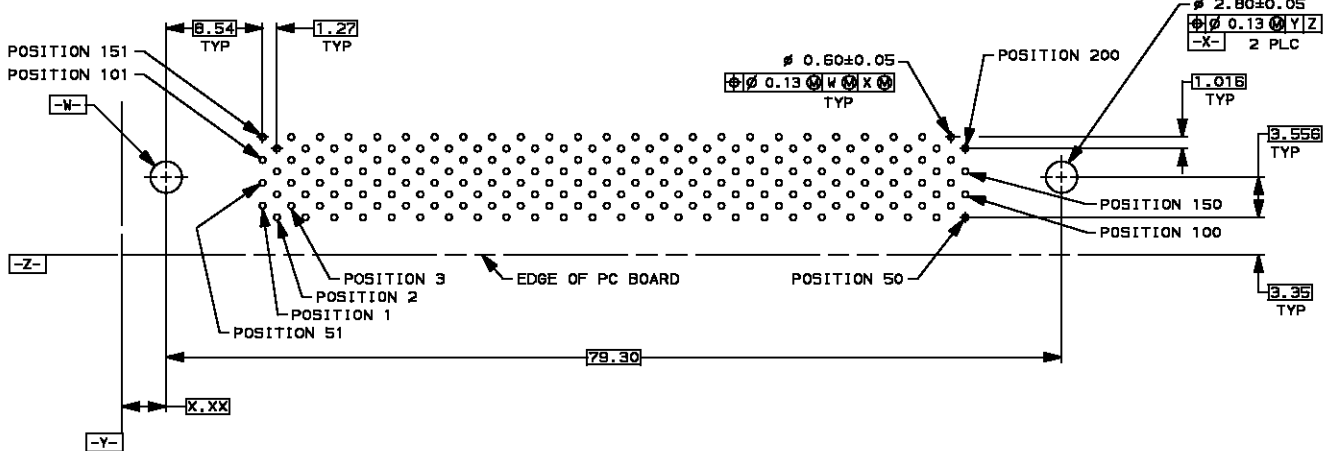

Figure 2 (cont'd)

8-Row Footprint (200-Position for Right-Angle Plug – Standard Shell Orientation)



8-Row Footprint (200-Position for Right-Angle Plug – Inverted Shell Orientation)



8-Row Footprint (240-Position for Right-Angle Plug)

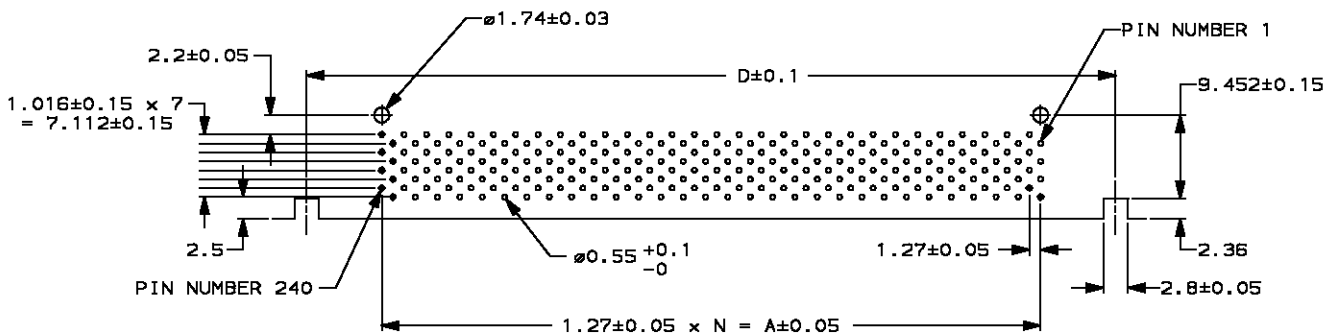
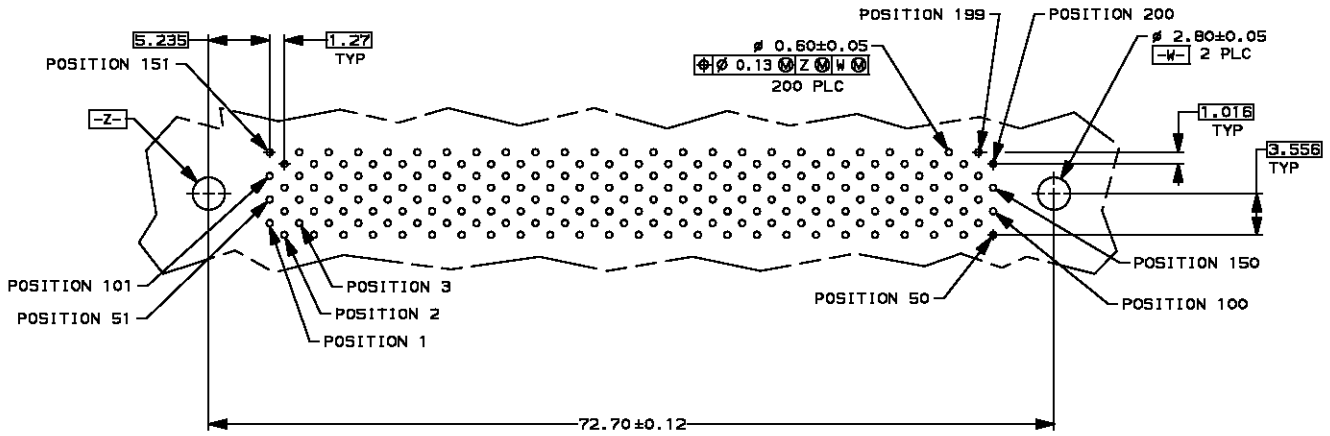
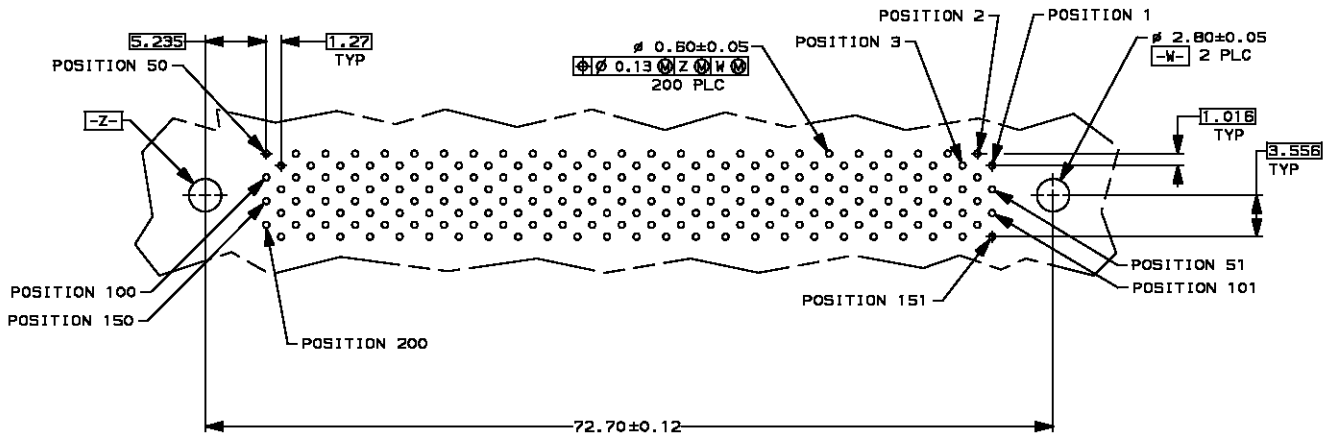

Figure 2 (cont'd)

8-Row Footprint (200-Position for Vertical Plug – Inverted Shell Orientation)



8-Row Footprint (72-, 200-, and 240-Position for Vertical Plug)



8-Row Footprint (200-Position for Right Angle Receptacle)

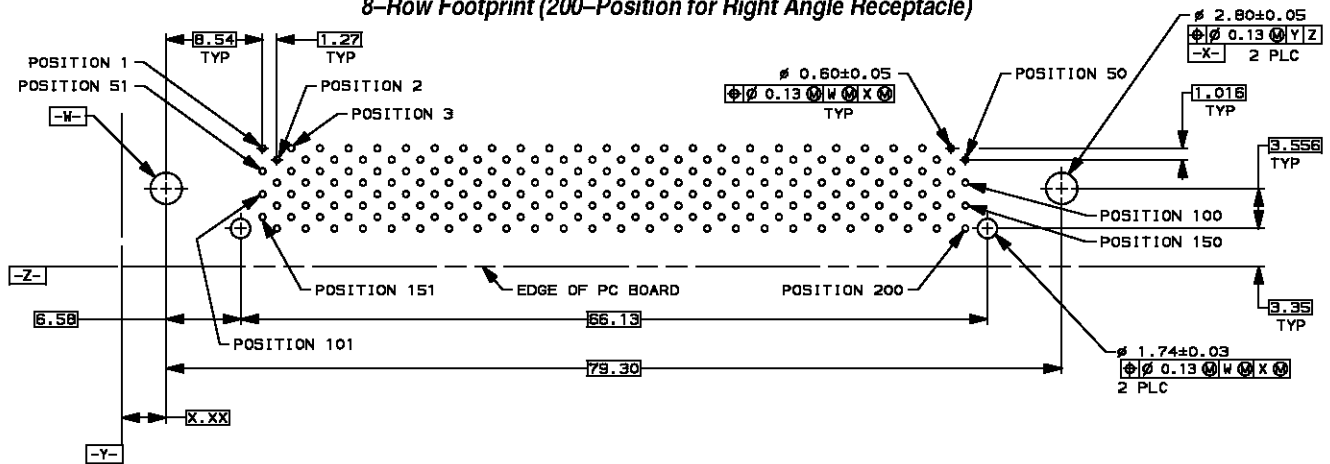

Figure 2 (end)

3.4. PC Board Contact Tine Holes

The holes in the pc board for contact tines must be drilled and plated through to specific dimensions. See Figure 3.

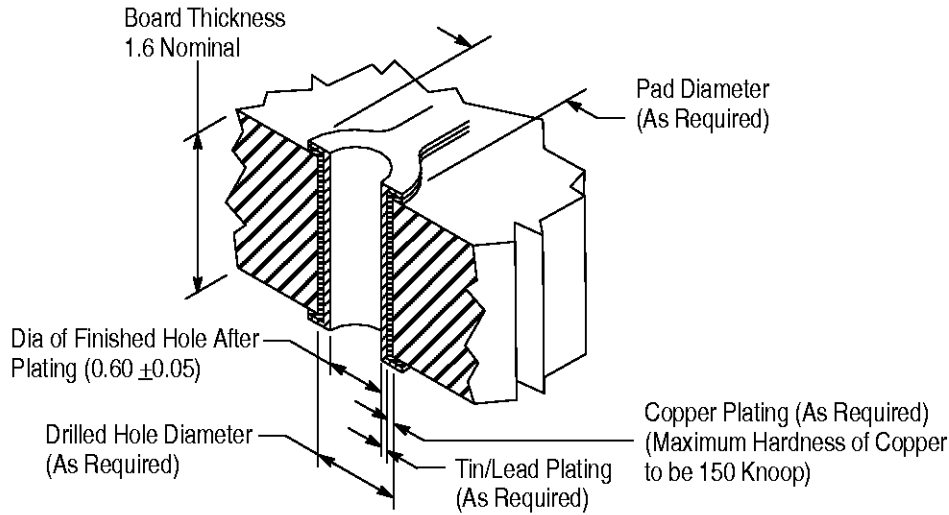

Figure 3

3.5. Mating Configurations

Figure 4 shows various typical mating combinations for CHAMP .050 Series Low Profile Docking Connectors.

3.6. Polarization Features

The connector is inherently polarized. The keystone configuration of each connector mating face prohibits the accidental inversion of mating connectors. See Figure 4.

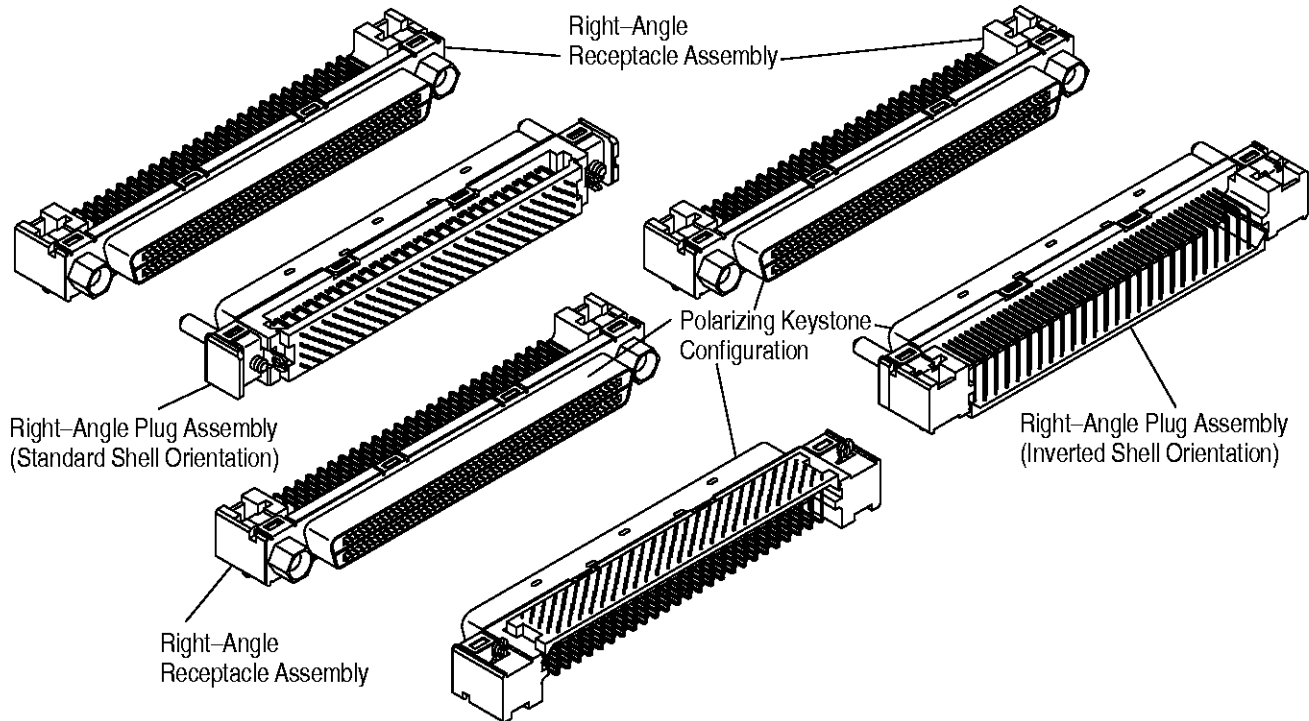

Figure 4

3.7. Mating Dimensions

These dimensions are required to ensure full mating of connectors with a minimum contact wipe of 0.64 mm. These dimensions must be considered when determining the method of mounting the connector. See Figure 5.

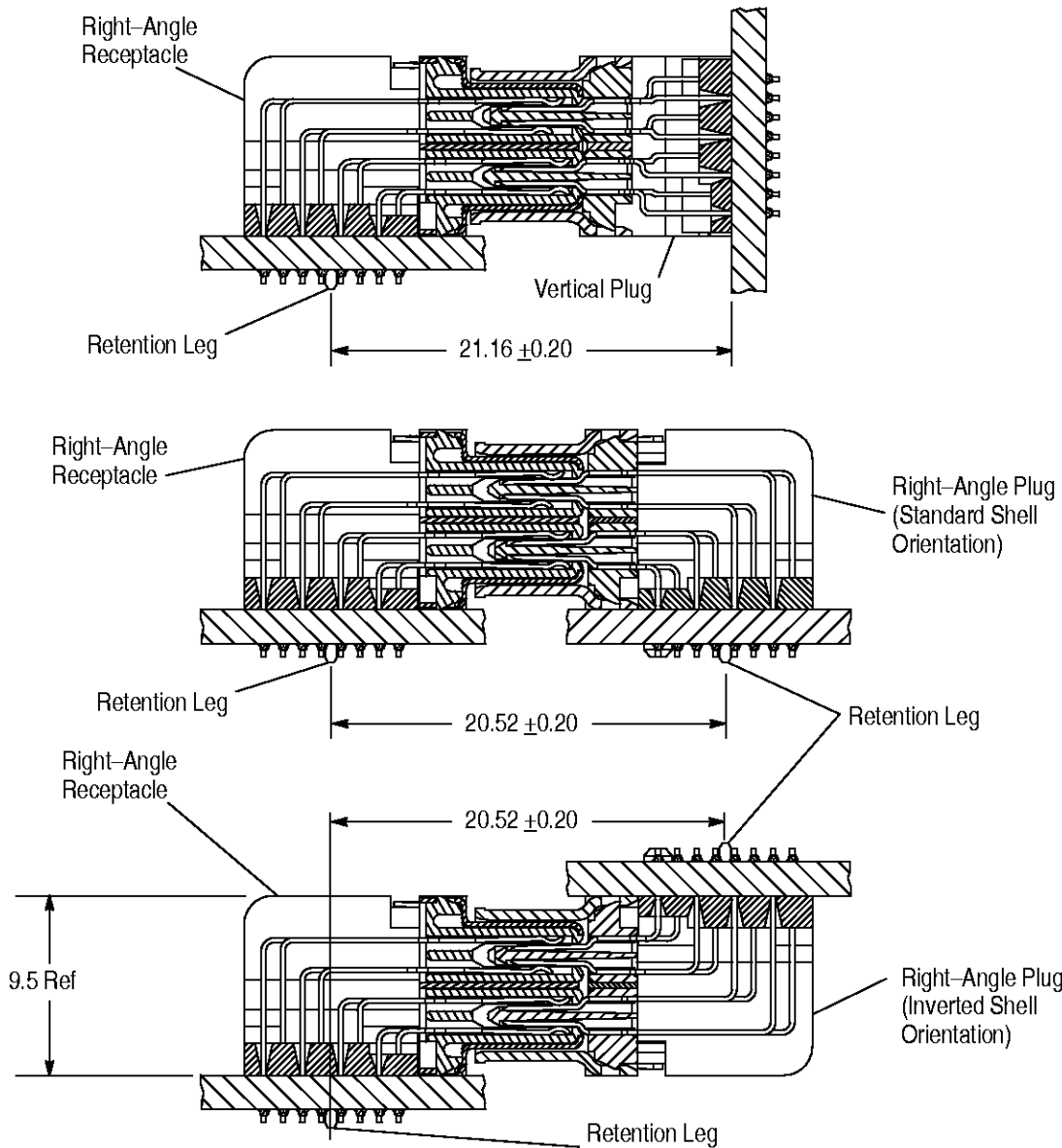

Figure 5

3.8. PC Board Spacing

Figure 6 provides information on connector clearance zones and spacing that must be considered regarding the placement of the connectors on a pc board.

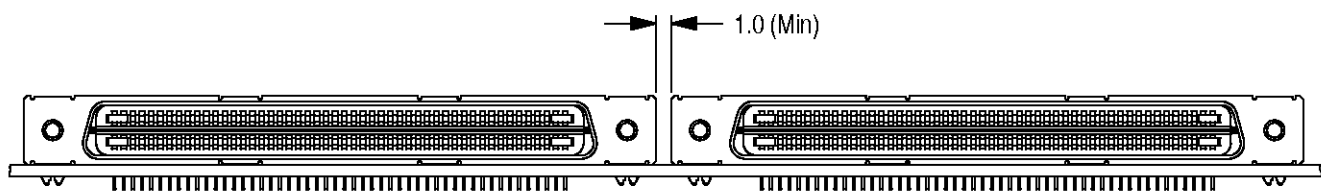

Figure 6

3.9. Circuit Identification

Circuit identification depends on the orientation of the plug shell. See Figure 7.

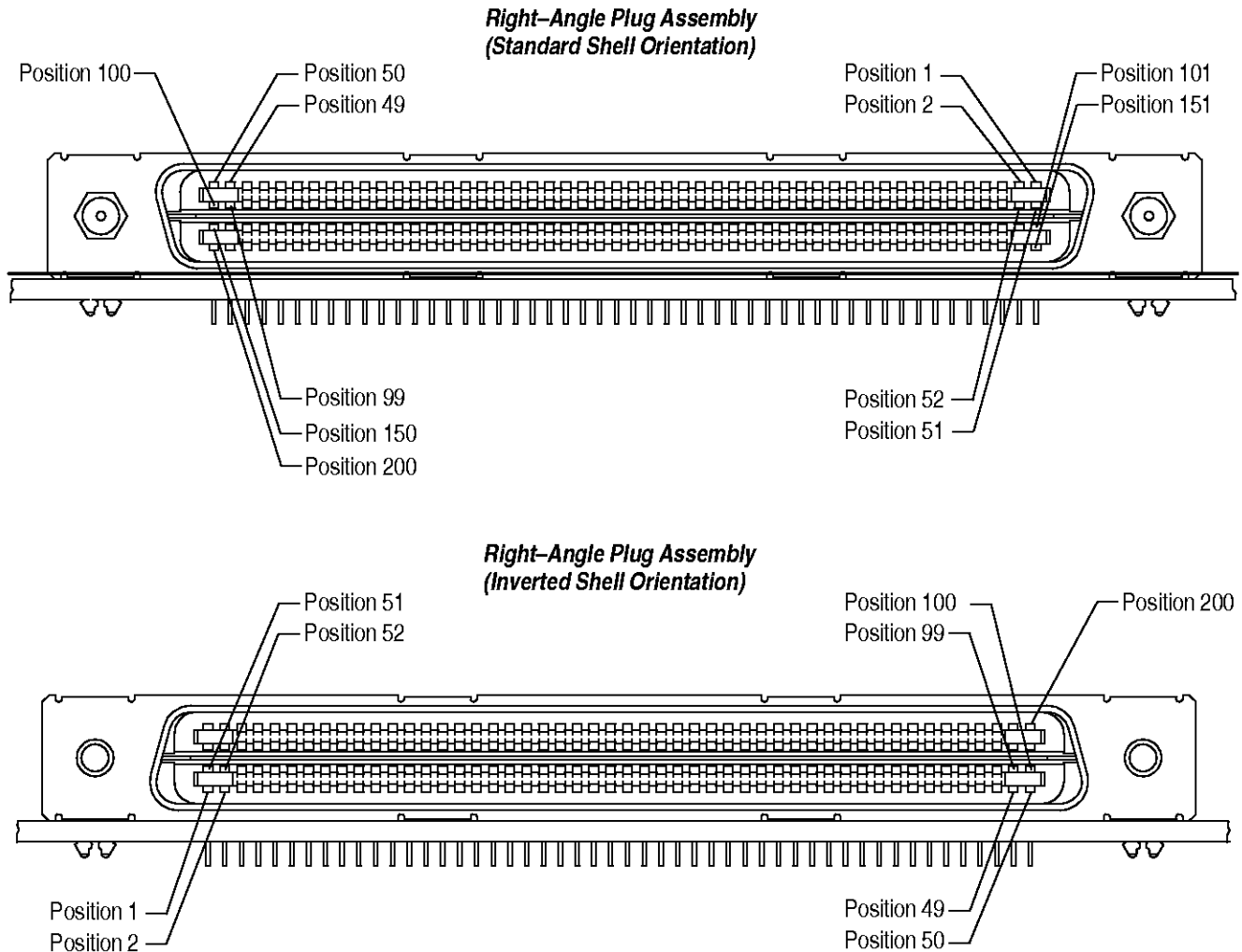

Figure 7

3.10. Limitations

Refer to the applicable AMP Product Specifications listed in Paragraph 2.5 for test procedures regarding these connectors.

3.11. Shielding

These connectors feature nickel-plated shells which provide continuity for electromagnetic compatibility (EMC) applications. When mated with corresponding metal shell connectors, shielding and grounding continuity are achieved.

3.12. Panel Mounting

Panel mounting is optional for the CHAMP .050 Series Low Profile Docking Connectors. Certain connectors are assembled with guide hardware pre-installed. The guide pins are used with plug connectors and guide sockets with receptacles. Other connectors require the hardware (purchased separately) to panel-mount the connectors.

Panel mounting provides additional support for the solder joints during mating and unmating of connectors and promotes EMC effectiveness. The connectors are to be mounted to the rear of the panel only. The recommended panel thickness is 0.55 to 1.20. See Figure 8 for cutout dimensions.

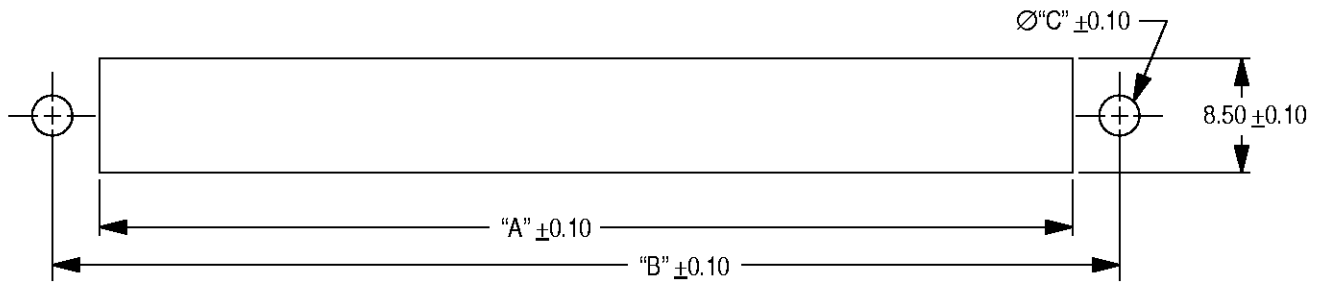

POSITION SIZE	RECEPTACLE DIMENSIONS			PLUG DIMENSIONS		
	A	B	C	A	B	C
72	31.66	38.66	5.20	32.16	38.66	3.00
160	59.60	66.60		60.10	66.60	
200	72.30	79.30		72.80	79.30	
240	85.00	92.00		85.50	92.00	

Figure 8

3.13. Retention Legs

The retention legs have gripping shoulders that pass through the pc board as the contact tines are inserted through the boards. They lock into position when the housing is seated flush with the board. See Figure 9.

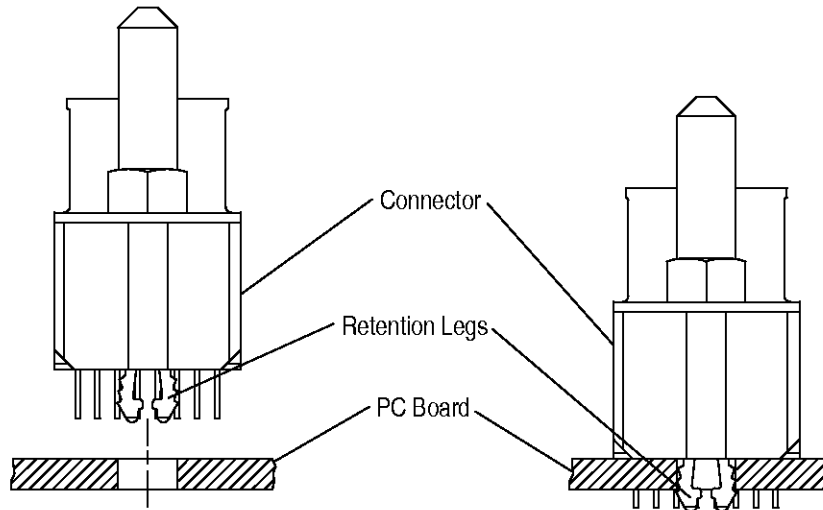

Figure 9

3.14. Connector Placement

CAUTION The connector should be handled only by the housing to avoid deformation, contamination, or other damage to the contact tines.

A. Manual Placement

Determine which hole in the pc board is to receive the number one contact tine, then orient the connector so the number one solder tine is aligned with the hole. Start all solder tines into the board; then, when the retention legs start to engage the pc board, press the connector until it seats on the pc board.

B. Robotic Placement

CHAMP .050 Series Low Profile Docking Connectors are *NOT* designed to be placed robotically onto pc boards.

3.15. Soldering

CHAMP .050 Series Low Profile Docking Connectors can be wave soldered, provided the temperatures and exposure time are within the ranges specified in Figure 10. AMP recommends the use of SN60 or SN62 solder for the connectors. Refer to Paragraph 2.4 for instructional material that is available for establishing soldering guidelines.

SOLDERING PROCESS	TEMPERATURE●		TIME (At Max Temp)
	CELSIUS	FAHRENHEIT	
WAVE SOLDERING	260	500	5 Seconds

● Wave Temperature

Figure 10

A. Flux Selection

Contact solder tines must be fluxed prior to soldering with a mildly active, rosin base flux. Selection of the flux will depend on the type of pc board and other components mounted on the board. Additionally, the flux must be compatible with the wave solder line, manufacturing, health, and safety requirements. Call one of the AMP phone numbers at the bottom of page 1 for consideration of other types of flux. Some fluxes that are compatible with these connectors are provided in Figure 11.

FLUX TYPE	ACTIVITY	RESIDUE	COMMERCIAL DESIGNATION	
			KESTER®	ALPHA■
Type RMA (Mildly Activated)	Mild	Noncorrosive	186	611

® Product of Kester Solder Co.

■ Product of Alphametals Inc.

Figure 11

B. Cleaning

After soldering, removal of fluxes, residues, and activators is necessary. Cleaning methods depend on the type of flux used. Consult the supplier of solder and flux for recommended cleaning solvents. The following are common cleaning solvents that can be used on these connectors for 10 minutes at room temperature without any adverse effects on contacts or housing. See Figure 12.

DANGER Consideration must be given to toxicity and other safety requirements recommended by the solvent manufacturer. Refer to the manufacturer's Material Safety Data Sheet (MSDS) for characteristics and handling of cleaners. Trichloroethylene and Methylene Chloride can be used with no harmful affect to the connectors; however AMP does not recommend them because of the harmful occupational and environmental effects. Both are carcinogenic (cancer-causing) and Trichloroethylene is harmful to the earth's ozone layer.

NOTE If you have a particular solvent that is not listed, contact the Product Information number at the bottom of page 1.

CLEANER		TIME (Minutes)	TEMPERATURES (Maximum)	
NAME	TYPE		CELSIUS	FAHRENHEIT
Alpha 2110■	Aqueous	1	132	270
Bioact EC-7◆	Solvent	5	100	212
Butyl Carbitol●	Solvent	1	Room Ambient	
Isopropyl Alcohol	Solvent	5	100	212
Kester 5778⚡	Aqueous	5	100	212
Kester 5779⚡	Aqueous	5	100	212
Loncoterge 520●	Aqueous	5	100	212
Loncoterge 530●	Aqueous	5	100	212
Terpene Solvent	Solvent	5	100	212

■ Product of Fry's Metals, Inc.

◆ Product of Petroferm, Inc.

● Product of Union Carbide Corp.

⚡ Product of Litton Systems, Inc.

Figure 12

C. Drying

When drying cleaned assemblies and pc boards, make certain that temperature limitations of -48.4° to 40.5°C [-55° to 105°F] are not exceeded.

CAUTION Excessive temperatures may cause housing degradation.

D. Checking Installed Connector

All solder joints should conform to those specified in AMP Workmanship Specification 101-21. The housing must seat on the pc board. See Figure 13.

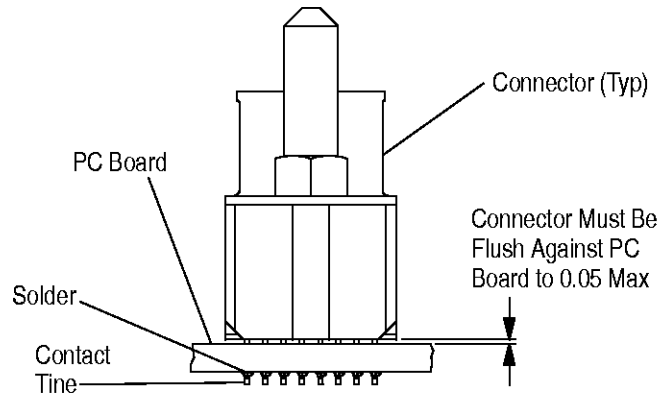

Figure 13

3.16. Precautions Relating to Known Abuse or Misuse

CAUTION CHAMP .050 Series Low Profile Docking Connectors will tolerate misalignments up to ± 2.0 mm during mating. However, the connectors are not designed to provide mechanical support between circuit boards within a system. One half of the interface (one board) must be allowed to float, otherwise forces across the connector interface may result in signal discontinuities.

3.17. Repair/Removal

Damaged connectors must be removed, discarded, and replaced with new ones. Soldered contacts may be removed from the pc board by standard desoldering methods. Refer to Paragraph 2.4 for soldering information.

4. QUALIFICATIONS

The CHAMP .050 Series Low Profile Docking Connectors are not required to be listed or recognized by Underwriters Laboratories Inc. (UL), or the Canadian Standards Association (CSA).

5. TOOLING

A pc board support (see Figure 14) should be used to prevent bowing of the pc board during the placement of a connector on the board. It should have flat surfaces with holes or a channel wide enough and deep enough to receive the solder tines and retention lets during installation of the connector on the board. Refer to Paragraph 2.6.

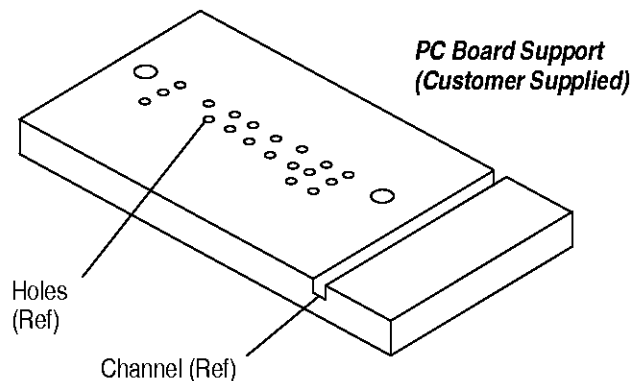
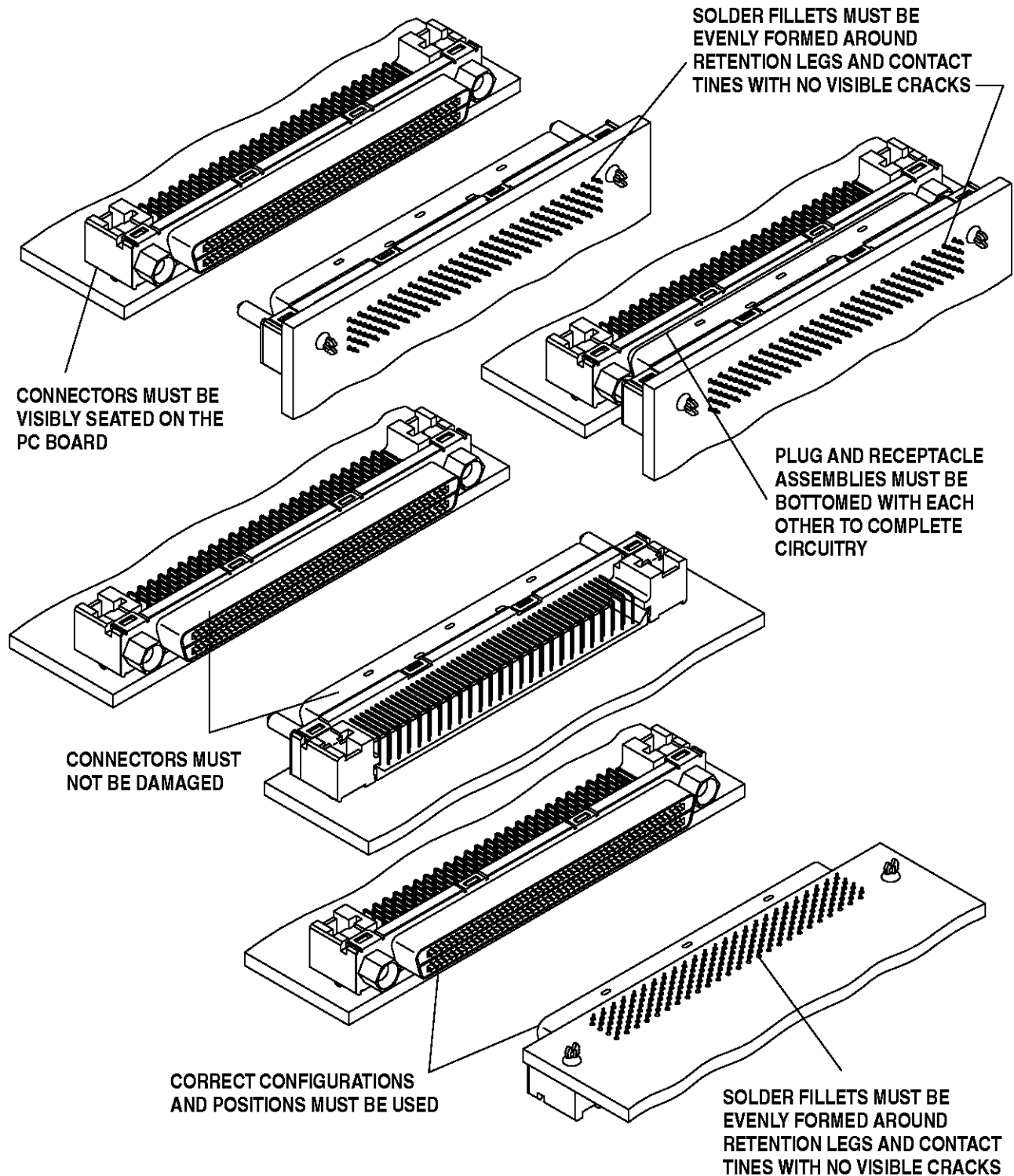

Figure 14

6. VISUAL AID

Figure 15 shows a typical application of CHAMP .050 Series Low Profile Docking Connectors. This illustration should be used by production personnel to ensure a correctly applied product. Applications which **DO NOT** appear correct should be inspected using the information in the preceding pages of this specification and in the instructional material shipped with the product or tooling.

**FIGURE 15. VISUAL AID**