



PRINTED CIRCUIT CONNECTORS

A complete selection of printed circuit board connectors to meet the reliability requirements of every type of application. Special plating techniques provide controlled plating thickness and low porosity of connector contacts to meet the most sensitive circuit requirements. AMP tooling and equipment assure superior terminations for all wire and contact sizes.

Two-piece printed circuit edge connectors, blade type contacts	13-3
AMP-BLADE Connectors	
Two-piece board to board box contact connectors . . .	13-9
Box Contact Connectors	
Two-piece board to board or wire to board rib and beam type contact connectors	13-31
AMP-MECA Subminiature Connectors	
One-piece dual and quad position edge connectors, tab type contacts	13-36
AMP-TAB Connectors	
Two-piece connector system, bayonet-type contacts	13-42
TERMI-GRID Connectors	
One-piece printed circuit edge connectors, leaf type contacts	13-47
AMP-LEAF Connectors	
One-piece edge connectors, bifurcated leaf type contacts	13-59
Twin Leaf Connectors	
One-piece board to board connectors, bifurcated leaf type contacts	13-66
Twin Leaf Mother Board Connectors	
One-piece card entry edge connector, bifurcated contacts for point-to-point wiring applications	13-76
TERMI-TWIST Connectors Wrap-Type Connectors	
One-piece card entry connectors, bifurcated contacts with .025" sq. termination technology for point-to-point wiring	13-83
Wrap-Type Printed Circuit Connectors	
One-piece card entry connectors for aluminum panel mounting	13-90
TERMI-PLATE Connectors	
Modified fork connectors	13-92
Bifurcated Leaf-Type Contact Connectors	13-95
Flag type one-piece edge connectors	13-100
Multiple Tap edge connectors	13-102
AMP Wrap Connectors with .025" sq. posts	13-105

(Continued on 13-2)

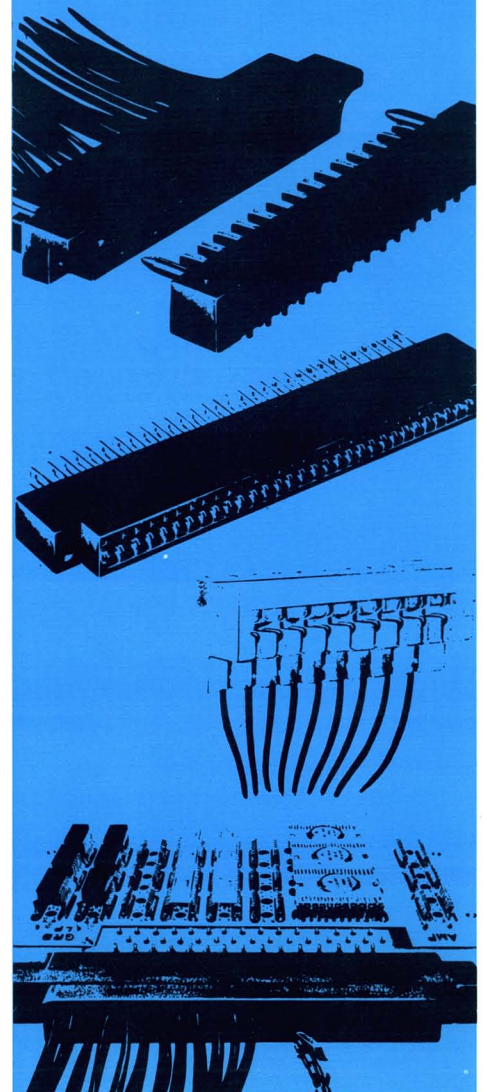

(Continued from 13-1)

Economy Wrap Connectors with .025" sq. posts	13-109
Low Profile one-piece board to board or wire to board connectors	13-115
Commercial printed circuit board connector, leaf type contacts	13-126
High current edge connector	13-128
Printed circuit connector hood assemblies	13-130
Laminar board to board interconnect system	13-133
Resistance Soldered Bus Strips	13-138
Cross-reference — other printed circuit type connectors	13-70

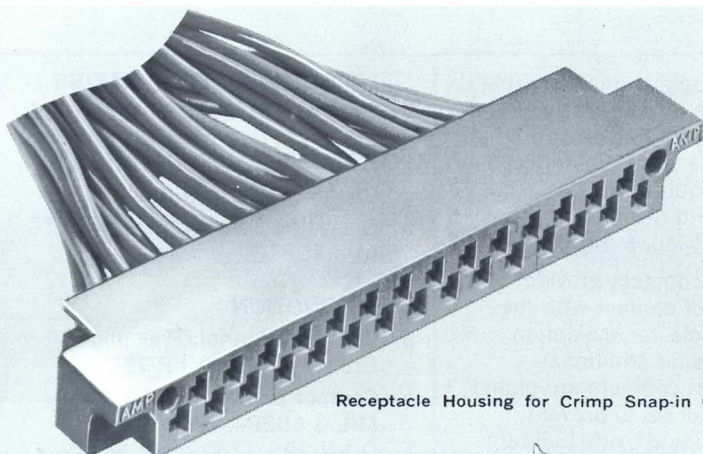

Receptacle Housing for Crimp Snap-in Contacts

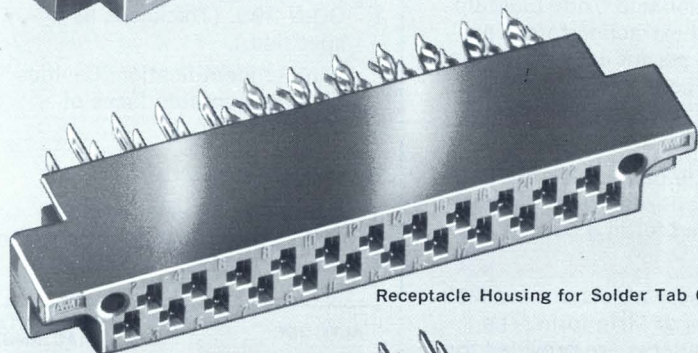

Receptacle Housing for Solder Tab Contacts

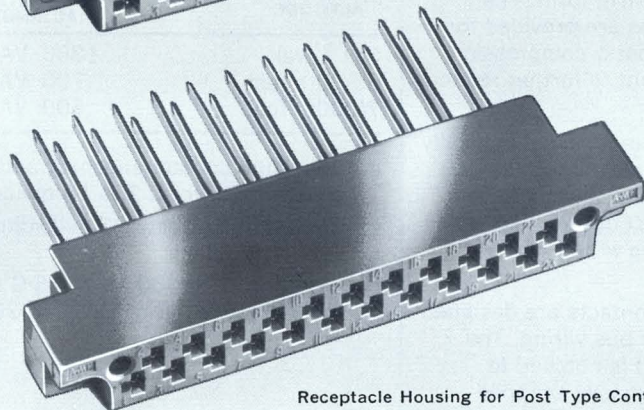

Receptacle Housing for Post Type Contacts

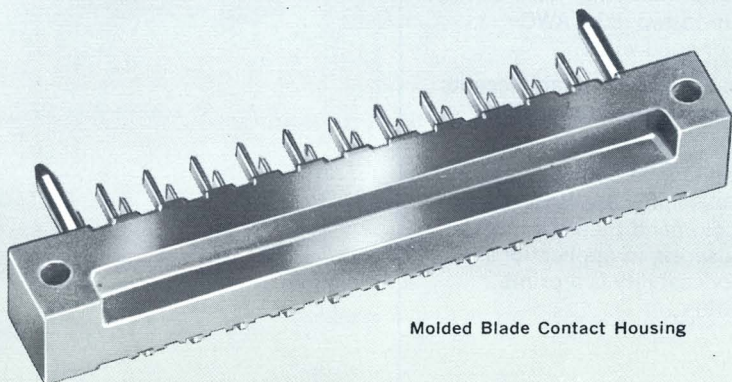

Molded Blade Contact Housing

AMP-BLADE Two Piece Printed Circuit Edge Connector

MIL-C-21097
MIL-E-5400

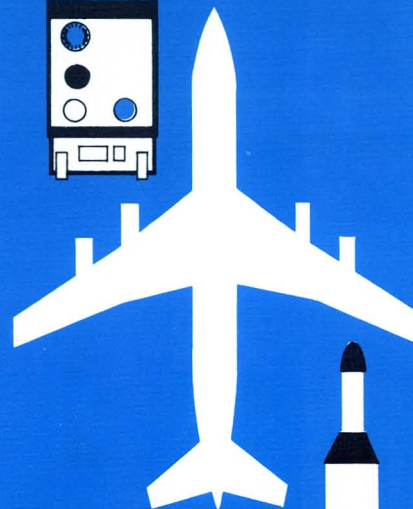
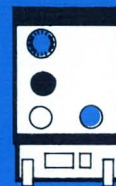

AMP-BLADE Two Piece Printed Circuit Edge Connectors

Designed for applications requiring the highest level of conductivity and reliability, this two piece board edge connector meets all of the applicable performance requirements of MIL-C-21097 and design requirements of MIL-E-5400.

The blade type contacts provide multiple areas of contact with the mating receptacle for maximum conductivity. As an additional reliability factor, contacts are plated with gold over nickel to prevent metal migration and oxide build-up. Insertion and extraction forces are controlled to permit easy mating and unmating of connector assemblies. Blade contacts for the board half are molded into the housing.

The receptacle half accepts a variety of contacts, but requires only those contacts called for in a particular circuit.

Crimp snap-in contacts are available in loose piece or strip form. The strip form contacts are provided for high-speed automatic compression crimping equipment to further reduce the installed cost.

The post type contacts are specifically designed to be wired with AMP TERMI-POINT* clips and tools. This connector and post design also adapts itself to the wrap-type termination.

The split eyelet contacts are designed to simplify solder bus wiring. The end of the contact is notched to permit wire to be easily snapped into place for soldering. Each contact accepts up to two #18 AWG stranded or solid wires.

The standard eyelet contact accepts up to two #18 AWG stranded or two #16 AWG solid wires.

High reliability, versatility, and speed of assembly are features which recommend these connectors for dense wiring in applications where serviceability is a prime consideration.

PRODUCT SPECIFICATIONS (FOR DIALYL PHTHALATE ONLY)

ELECTRICAL CHARACTERISTICS

- Contact Rating: 5 Amps.
- Operating Temperature: -65°C to $+125^{\circ}\text{C}$.

CONSTRUCTION

- Contact material: Phosphor Bronze — Per QQ-B-750.
- Contact plating: Gold Plate — MIL-G-45204, Nickel Plate — QQ-N-290. (Thickness as specified.)
- Contact identification: Cavities identified on both faces of receptacle block.

PERFORMANCE

This connector meets all the applicable performance requirements of MIL-C-21097.

ALTITUDE	TEST VOLTAGE (AC RMS)
Sea Level	1800 VAC
50,000 feet	700 VAC
70,000 feet	500 VAC

- Individual contact engaging and separating forces: 2 to 16 ounces.
- Contact resistance: 25 millivolts max. at 5 Amps.
- Vibration: 10-2000 hz @ 15 G's per method 204B of MIL-STD-202.

ALL DIMENSIONS IN INCHES



Board Half
Housing
Pre-loaded with
Blade Type Contacts

Blade Contact Material: Gilding Metal
Plating: Commercial Type — .00003 Gold over .00003 Nickel (Diallyl Phthalate Housings)
.000015 Gold over .00003 Nickel (Phenolic Housings)
Military Type — .00003 Gold over .00003 Nickel (Diallyl Phthalate Housings)

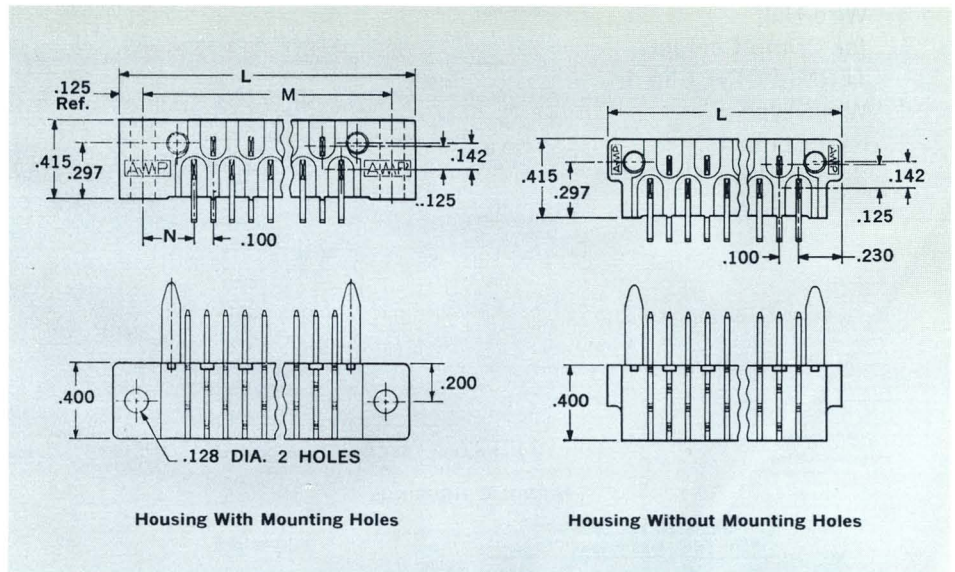

HOUSINGS WITH MOUNTING HOLES

NO. OF POSITIONS	L (MAX.)	M	N	PRINTED CIRCUIT BOARD THICKNESS	COMMERCIAL TYPE		MILITARY TYPE CS — PLUG	
					PHENOLIC HOUSING	DIALYL PHTHALATE HOUSING	DIALYL PHTHALATE HOUSING	
							MILITARY PART NO.	AMP PART NO.
17	2.390	2.130	.265	1/16	1-582390-1	3-582152-1	21097/14-01	582843-2
				3/32	2-582390-1	6-582152-1	21097/14-02	1-582843-4
				1/8	3-582390-1	9-582152-1	21097/14-03	2-582843-5
23	2.990	2.730	.265	1/16	1-582390-2	3-582152-2	21097/14-04	582843-3
				3/32	2-582390-2	6-582152-2	21097/14-05	582843-1
				1/8	3-582390-2	9-582152-2	21097/14-06	2-582843-6
29	3.590	3.330	.265	1/16	1-582390-3	3-582152-3	21097/14-07	582843-4
				3/32	2-582390-3	6-582152-3	21097/14-08	1-582843-5
				1/8	3-582390-3	9-582152-3	21097/14-09	2-582843-7
35	4.190	3.930	.265	1/16	1-582390-4	3-582152-4	21097/14-10	582843-5
				3/32	2-582390-4	6-582152-4	21097/14-11	1-582843-6
				1/8	3-582390-4	9-582152-4	21097/14-12	2-582843-8
41	4.790	4.530	.265	1/16	1-582390-5	3-582152-5	21097/14-13	582843-6
				3/32	2-582390-5	6-582152-5	21097/14-14	1-582843-7
				1/8	3-582390-5	9-582152-5	21097/14-15	2-582843-9
47	5.623	5.363	.381	1/16	1-582390-6	3-582308-1	21097/14-16	582843-7
				3/32	2-582390-6	6-582308-1	21097/14-17	1-582843-8
				1/8	3-582390-6	9-582308-1	21097/14-18	3-582843-0

HOUSINGS WITHOUT MOUNTING HOLES

17	2.070	—	—	1/16	4-582390-1	3-582152-6	21097/15-01	582843-8
				3/32	5-582390-1	6-582152-6	21097/15-02	1-582843-9
				1/8	6-582390-1	9-582152-6	21097/15-03	3-582843-1
23	2.670	—	—	1/16	4-582390-2	3-582152-7	21097/15-04	582843-9
				3/32	5-582390-2	6-582152-7	21097/15-05	2-582843-0
				1/8	6-582390-2	9-582152-7	21097/15-06	3-582843-2
29	3.270	—	—	1/16	4-582390-3	3-582152-8	21097/15-07	1-582843-0
				3/32	5-582390-3	6-582152-8	21097/15-08	2-582843-1
				1/8	6-582390-3	9-582152-8	21097/15-09	3-582843-3
35	3.870	—	—	1/16	4-582390-4	3-582152-9	21097/15-10	1-582843-1
				3/32	5-582390-4	6-582152-9	21097/15-11	2-582843-2
				1/8	6-582390-4	9-582152-9	21097/15-12	3-582843-4
41	4.470	—	—	1/16	4-582390-5	3-582152-0	21097/15-13	1-582843-2
				3/32	5-582390-5	6-582152-0	21097/15-14	2-582843-3
				1/8	6-582390-5	9-582152-0	21097/15-15	3-582843-5
47	5.070	—	—	1/16	4-582390-6	3-582308-2	21097/15-16	1-582843-3
				3/32	5-582390-6	6-582308-2	21097/15-17	2-582843-4
				1/8	6-582390-6	9-582308-2	21097/15-18	3-582843-6

NOTES: 1. Blade contacts (gold plated) are molded into housing in predetermined positions to mate with receptacle housing. This assembly affixes to printed circuit board using clinching tools. 2. Connectors can be furnished with the two middle rows of tines removed to fit existing board hole patterns.

Wire Half
for Crimp Contacts,
TERMI-POINT Clip or
Wrap-Type
Post Contacts,
Solder/Weld Contacts

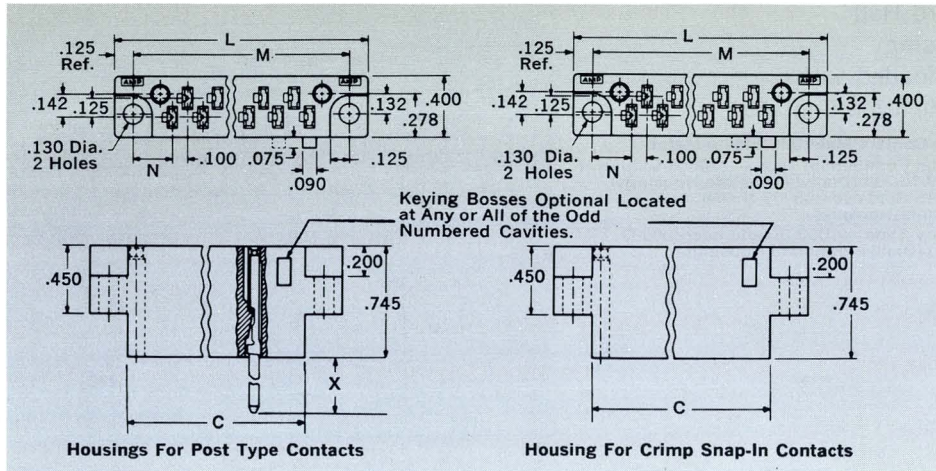

PHENOLIC HOUSINGS

NO. OF POS.	HOUSING PRELOADED WITH POST TYPE CONTACTS**			HOUSING FOR CRIMP OR EYELET TYPE CONTACTS	DIMENSIONS			C*
	X	PART NUMBER	NO. OF TERMI-POINT CLIPS		L	M	N	
17	1.000	582833-1	4	1-582389-1	2.390	2.130	.265	1.910
	.770	582833-2	3					
	.600	582833-3	2					
	.370	582833-4	1					
23	1.000	582834-1	4	1-582389-2	2.990	2.730	.265	2.510
	.770	582834-2	3					
	.600	582834-3	2					
	.370	582834-4	1					
29	1.000	582835-1	4	1-582389-3	3.590	3.330	.265	3.110
	.770	582835-2	3					
	.600	582835-3	2					
	.370	582835-4	1					
35	1.000	582836-1	4	1-582389-4	4.190	3.930	.265	3.710
	.770	582836-2	3					
	.600	582836-3	2					
	.370	582836-4	1					
41	1.000	582837-1	4	1-582389-5	4.790	4.530	.265	4.310
	.770	582837-2	3					
	.600	582837-3	2					
	.370	582837-4	1					
47	1.000	582838-1	4	1-582389-6	5.623	5.363	.381	5.143
	.770	582838-2	3					
	.600	582838-3	2					
	.370	582838-4	1					

NOTE: For contact information see back page.
* Cutout dimension for mounting.
** Contact Material: Phosphor Bronze, .000015 Gold over .000030 Nickel plated.
Post Material: Brass, Tin plated.

DIALLYL PHTHALATE HOUSINGS

NO. OF POS.	HOUSING PRELOADED WITH POST TYPE CONTACTS**			HOUSING FOR CRIMP OR EYELET TYPE CONTACTS			DIMENSIONS			C*
	X	PART NUMBER	NO. OF TERMI-POINT CLIPS	COMMERCIAL TYPE PART NO.	MILITARY TYPE CR — RECEPTACLE		L	M	N	
					MILITARY PART NO.	AMP PART NO.				
17	1.000	582828-1	4	3-582151-1	21097/13-01	5-582151-1	2.390	2.130	.265	1.910
	.770	582828-2	3							
	.600	582828-3	2							
	.370	582828-4	1							
23	1.000	582829-1	4	3-582151-2	21097/13-02	5-582151-2	2.990	2.730	.265	2.510
	.770	582829-2	3							
	.600	582829-3	2							
	.370	582829-4	1							
29	1.000	582830-1	4	3-582151-3	21097/13-03	5-582151-3	3.590	3.330	.265	3.110
	.770	582830-2	3							
	.600	582830-3	2							
	.370	582830-4	1							
35	1.000	582831-1	4	3-582151-4	21097/13-04	5-582151-4	4.190	3.930	.265	3.710
	.770	582831-2	3							
	.600	582831-3	2							
	.370	582831-4	1							
41	1.000	582832-1	4	3-582151-5	21097/13-05	5-582151-5	4.790	4.530	.265	4.310
	.770	582832-2	3							
	.600	582832-3	2							
	.370	582832-4	1							
47	1.000	582819-1	4	3-582307-1	21097/13-06	5-582307-1	5.623	5.363	.381	5.143
	.770	582819-2	3							
	.600	582819-3	2							
	.370	582819-4	1							

NOTE: For contact information see back page.
* Cutout dimension for mounting.
** Contact Material: Phosphor Bronze, .000030 Gold over .000030 Nickel plated.
Post Material: Brass, Tin plated.

Contacts, Key Information and Board Layout

Snap-In Receptacle Contacts

Contact Material: Phosphor Bronze
Plating: Commercial Type — .00003 Gold over .00003 Nickel; Military Type — .00005 Gold over .00003 Nickel



WIRE RANGE	INSULATION RANGE	COMMERCIAL TYPE		MILITARY TYPE		
		STRIP FORM PART NO.	LOOSE PIECE FORM PART NO.	MILITARY PART NO.	STRIP FORM PART NO.	LOOSE PIECE FORM
24-20	.040-.080	66005-2	66010-2	21097/16-03	66005-3	66010-3
28-24	.030-.060	66009-2	66011-2	21097/16-01	66009-3	66011-3
Two 20 or Two 22	Two .045 to Two .072	66021-2	66026-2	21097/16-04	66021-3	66026-3
18	.067-.090	66021-2	66026-2	21097/16-04	66021-3	66026-3
28-24	.078 Spec.	66027-2	66029-2	21097/16-02	66027-3	66029-3

POST TYPE CONTACTS

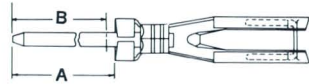

.031 x .062 Post Contacts
 Material — Phosphor Bronze Contacts
 Brass Posts

DIMENSIONS		PART NO.	PLATING	
A	B*		RECEPTACLE	POST
.410	.37C	1-582261-1	.000030 Gold over	Tin
.640	.600	1-582261-2	.000030 Nickel	
.810	.770	1-582261-3	.000030 Nickel	
1.040	1.000	1-582261-4		
.410	.370	582652-1	.000015 Gold over	Tin
.640	.600	582652-2	.000030 Nickel	
.810	.770	582652-3	.000030 Nickel	
1.040	1.000	582652-4		

*Extension from rear of Connector Block

SOLDER TAB CONTACTS

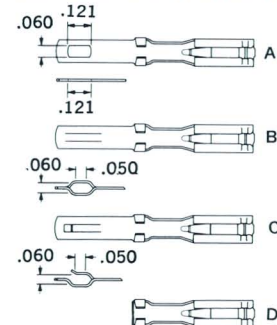

Material — Phosphor Bronze
 Plating — .00003 Gold over .00003 Nickel

RECEPTACLE CONTACT NUMBER (Loose Piece Form)	TYPE	MAXIMUM EXTENSION BEYOND BACK FACE OF BLOCK
66086-2	A	.390
66086-3	B	.375
66086-4	C	.375
583211-1* (Mil. Part No. 21097/17-01)	D	None

*.00005 Gold over .00003 Nickel plated

Keying

Method I — Polarization of connector halves is provided by permanent guide pins in blade contact housings. Keying can be provided by means of external bosses. Order by standard part number and specify which odd numbered positions should be provided with bosses on receptacle housing.

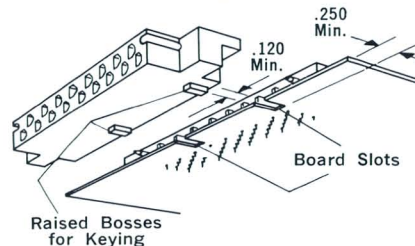

Method II — Insert keying plug into mating side of receptacle housing cavity. Remove corresponding blade contact in blade housing using tool No. 811145.

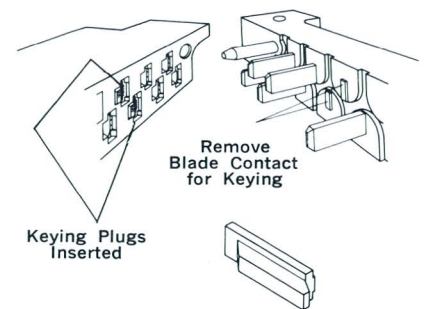

Keying Plug — Nylon
 AMP Part No. 1-582156-9
 Military Part No. 21097/11-07

Board Layout

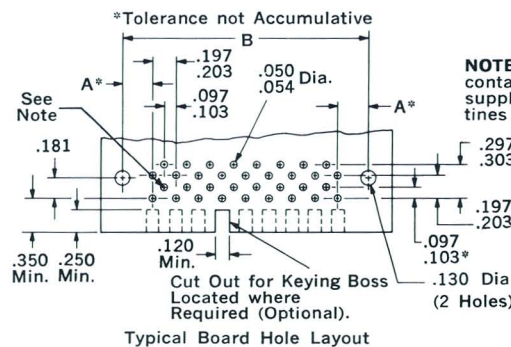

NOTE: If existing printed circuit board does not contain the two middle rows of holes, AMP can supply the connector with the middle rows of tines removed.

NO. OF POSITIONS	DIMENSIONS	
	A	B
17	.265	2.130
23	.265	2.730
29	.265	3.330
35	.265	3.930
41	.265	4.530
47	.381	5.363

**AMP-O-LECTRIC*
Automatic Machine**

Substantial savings and the benefits of mass production are obtained with the AMP-BLADE Printed Circuit Connector through the use of AMP automachine tooling. The AMP-BLADE receptacle contacts are available in strip form for this use (see table on AMP-BLADE receptacle contacts) and can be terminated to wire leads at rates up to 1500 per hour, depending on operator skill. Contact AMP for complete specifications and part numbers.

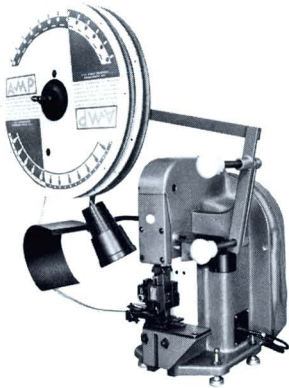

Hand Crimping Tools

HAND TOOL	RECEPTACLE CONTACT NO. (Loose Piece Form)	WIRE COMBINATIONS
90083	66010	One 24 or One 22 or One 20
	66010	Two 24 or Two 22
59524	66010	One 22 or One 20
	66011	One 26 or One 24
59525	66026	Two 22
	66026	Two 20
90005	66026	Two 20
	66026	One 18 or One 20
59529	66029	One 28 or One 26
90014	66026	Two 22 or Three 22



CLINCHING TOOL

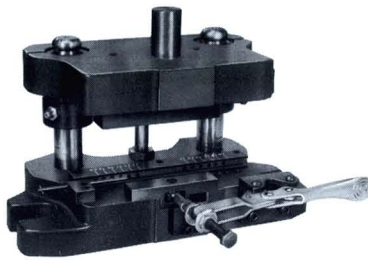
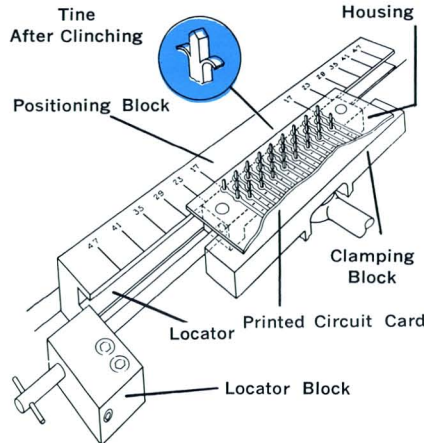

CLINCHING DIE SET 685075-2
(Accepts All Sizes of Clinching Blade Assemblies)

CLINCHING BLADE ASSEMBLIES	
17 Position	451072-1
23 Position	451072-2
29 Position	451072-3
35 Position	451072-4
41 Position	451072-5
47 Position	451072-6

BOLSTER PLATE Part No. 451028-1
(Optional — Used as a Base "Build Up" if the Press Throat Exceeds 5½")



Receptacle Contact Extraction Tool
AMP Part No. 465199-1
Military Part No. 21097/18-01

1000, 750 and 500 Series Box Contact Connectors (Military and Commercial)



Dimensioning:
All dimensions in inches and millimetres.
Values in brackets are metric equivalents.

Features

- Four elliptical spring beams on receptacle provide redundant areas of electrical contact
- Polarized diallyl phthalate housings
- 500 Series contacts on .100" [2.54 mm] staggered centers
- 750 Series contacts on .075" x .125" [1.91 mm x 3.18 mm] centers
- 1000 Series contacts on .100" x .100" [2.54 mm x 2.54 mm] centers
- Low insertion and withdrawal forces
- Receptacle contacts allow wide margins of pin misalignment to facilitate mating
- Individual pin and receptacle contacts can be extracted for replacement
- Receptacle tail configurations accommodate a variety of wiring methods
- Receptacle housing prevents overstressing of contacts
- Military connectors meet MIL-C-55302 requirements and are QPL listed.

Product Specifications

- Headers and Receptacles — Blue diallyl phthalate per MIL-M-14F
- Pin Protector — Anodized aluminum per QQ-A-250/1
- Pin Header Contacts — Brass per QQ-B-626; .000030" [0.0008 mm] gold over .000050" [0.0013 mm] nickel plated (commercial), .000050" [0.0013 mm] gold over .000050" [0.0013 mm] nickel plated (military); gold plating per MIL-G-45204
- Receptacle Contacts — Beryllium copper per QQ-C-533; .000030" [0.0008 mm] gold over .000030" [0.0008 mm] nickel plated (commercial), .000050" [0.0013 mm] gold over .000030" [0.0008 mm] nickel plated (military); gold plating per MIL-G-45204
- Current Rating — 3 A max. per contact, continuous
- Temperature Rating — -55°C to +125°C

Specifications subject to change.
Consult AMP Incorporated for latest design specifications.

AMP Box Contact Connectors are two-piece, board-to-board connectors especially designed for systems requiring up to several hundred contacts per connector. With latched-in pin and receptacle contacts, these high density connectors offer the lowest applied cost, yet maintain top performance and maximum reliability.

The receptacle contact employs a unique four-beam "box" design for accepting various square, rectangular, round or formed channel pins. This allows right-angle and straight-through pin headers to be built in single or multiple row configurations without a need to change the contact. The "box" design also provides redundant electrical contact areas, which is highly beneficial in vibration applications, and at the same time, allows for wide margins of pin misalignment to facilitate mating. The contact can be furnished with various tail shapes and sizes to accommodate a wide range of board hole sizes or to accept soldered wires. Also, posted versions are available to accept up to three wrap-type terminations per post.

AMP'S versatile family of box contact connectors offers the following header and receptacle configurations:

1000 Series Pin Header — Contains two rows of "U" shaped pins on a .100" [2.54 mm] square grid spacing. Edge-mount versions (Styles I and II) are available with or without shields, and have pre-tinned solder tabs for each connection to a daughter board. A right-angle mount version (Style III, with replaceable contacts) is provided with an integral pin shield.

1000 Series Receptacle — Contains two rows of box contacts on a .100" [2.54 mm] square grid spacing. It is available with contact styles that include: a flow solder type for pc board application; a solder eyelet version; a .010" x .020" [0.25 mm x 0.51 mm] posted version; and a card extender type for making daughter board connections. Also available is a .022" x .027" [0.56 mm x 0.69 mm] posted version for accepting one, two or three wire terminations per

post using miniature wrap-type terminating methods. The .022" x .027" [0.56 mm x 0.69 mm] posted versions are available for either rack or pc mounting.

750 Series Pin Header — Contains two rows of "U" shaped pins on .075" [1.91 mm] centers. Pins have pre-tinned tabs for each connection to a daughter board. The pin header is available in an edge-mount configuration only, either with or without pin shields.

750 Series Receptacle — Contains two rows of box contacts on .075" [1.91 mm] centers with .125" [3.18 mm] spacing between rows. It is available with contact styles that include: a flow solder type for pc board application; a solder eyelet version; a .010" x .020" [0.25 mm x 0.51 mm] posted version; and a card extender type for making daughter board connections.

500 Series Molded, Right-Angle Pin Header — Supplied with either two or three rows of .030" [0.76 mm] diameter pins on .100" [2.54 mm] staggered centers. Contacts are non-removable.

500 Series Receptacle — Supplied with either two or three rows of box contacts. Contacts in all receptacles are spaced on .100" [2.54 mm] staggered centers. Available contact styles include: flow solder, solder eyelet and .010" x .020" [0.25 mm x 0.51 mm] posted versions, plus a .022" x .027" [0.56 mm x 0.69 mm] posted contact which accepts three wrap-type terminations. This heavier posted version is designed for rack mounting.

All AMP Box Contact Connectors are designed to meet AMP Product Specification No. 108-9003, as well as those listed at the left.

Contacts

Dimensioning:

1. All dimensions in inches and millimetres. Values in brackets are metric equivalents.
2. Charts contain dimensions in inches over millimetres.

All pin and receptacle contacts are plated gold-over-nickel in various thicknesses. These thicknesses are coded in the charts as follows:

- 1 — .000030" [0.0008 mm] gold over .000050" [0.0013 mm] nickel
- 2 — .000050" [0.0013 mm] gold over .000050" [0.0013 mm] nickel
- 3 — .000030" [0.0008 mm] gold over .000030" [0.0008 mm] nickel
- 4 — .000050" [0.0013 mm] gold over .000030" [0.0008 mm] nickel

Pin Contacts

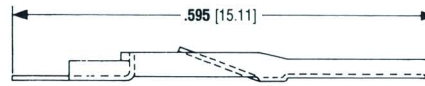

Pin Contact for Styles I and II

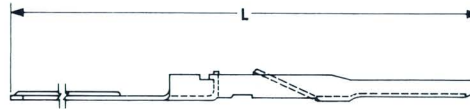

Pin Contact for Style III

Plating Code	AMP Part No.
1	202947-2
2	202947-3

Plating Code	L	AMP Part No.
1	.650 16.51	530300-3
	.835 21.21	530300-4
	.650 16.51	530300-7
2	.835 21.21	530300-8

Receptacle Contacts

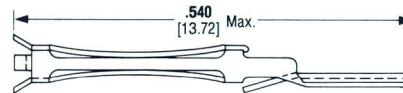

Flow Solder Contact for Pc Board Application

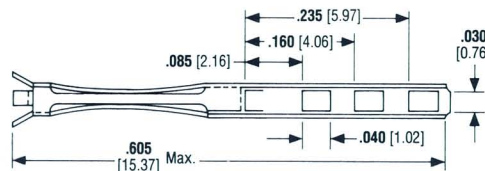

Solder Eyelet Contact (Max. Wire Size, #26 AWG [0.15 mm²])

Plating Code	AMP Part No.
3	202946-1
4	202946-3

Plating Code	MIL-Part No.	AMP Part No.
3	—	583218-1
4	M55302/32-01	583218-2

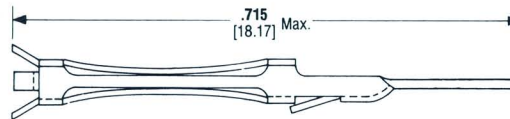

.010 x .020 [0.25 x 0.51] Posted Contact*

Plating Code	AMP Part No.
3	583452-4
4	1-583452-4

*.010 x .020 [0.25 x 0.51] posted contacts are used as replacement contacts on card extender assemblies.

Posted Box Contacts

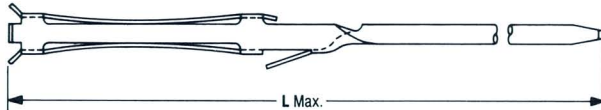

Wrap-Type Contact (.022 x .027 [0.56 x 0.69]) for Rack Mounting



Wrap-Type Contact (.022 x .027 [0.56 x 0.69]) for Pc Mounting

No. of Terminations	L	Plating Code 3		Plating Code 4	
		AMP Part No.	MIL-Part No.	AMP Part No.	MIL-Part No.
1 High	.795 20.2	1-583812-2	M55302/32-05	2-583812-2	
2 High	.955 24.26	1-583812-5	M55302/32-06	2-583812-0	
3 High	1.115 28.33	1-583812-8	M55302/32-07	2-583812-4	

No. of Terminations	L	Plating Code 3		Plating Code 4	
		AMP Part No.	MIL-Part No.	AMP Part No.	MIL-Part No.
1 High	.795 20.2	—	M55302/32-02	2-583812-6	
2 High	.955 24.26	—	M55302/32-03	2-583812-8	
3 High	1.115 28.33	583812-9	M55302/32-04	3-583812-0	

Contact Extraction

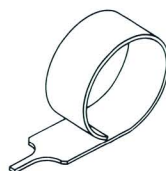

Extraction Tool for Receptacle Contacts, AMP Part No. 91035-1, MIL-Part No. M55302/28-01

All Receptacles — Insert tip of tool into rear of cavity and depress the locking lance. Push the contact through the cavity by pressing on the contact tail.

1000 and 750 Series Pin Headers — Slide a piece of .015" [0.38 mm] diameter piano wire from the face of the connector, along the channel in the pin contact and into the pin header cavity. This will flatten the lance on the pin contact. Push the pin contact through the cavity by pressing on the pin.

1000 Series Receptacle Assemblies

Dimensioning:
All dimensions in inches and millimetres.
Values in brackets are metric equivalents.

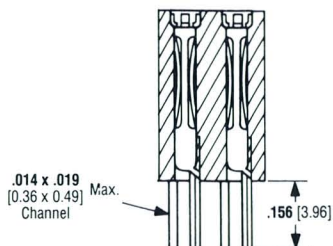
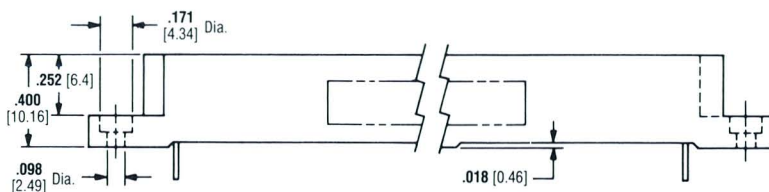
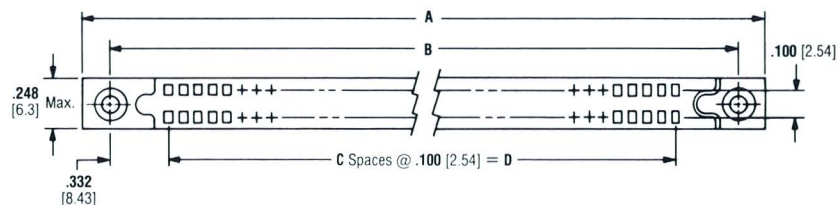

**Flow Solder Contact
for Pc Board Application***

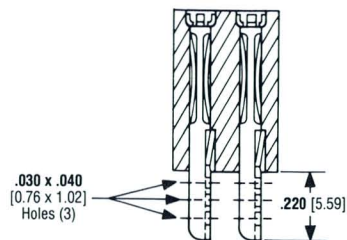

**Solder Eyelet Contact (Max. Wire
Size, #26 AWG [0.15 mm²])**

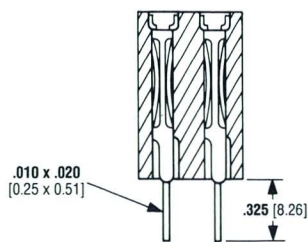

**.010 x .020 [0.25 x 0.51]
Posted Contact***

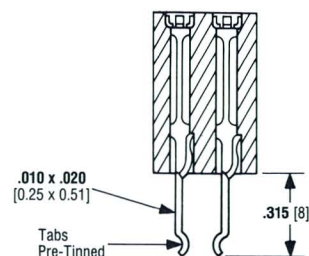

**Card Extender Type Contact*
(Use with .070/.054 [1.78/1.37] Board)**

Notes: 1. See page 13-24 for Recommended Pc Board Layout.
2. All Receptacle Assemblies will mate with the 1000 Series Pin Header Assemblies shown on pages 13-18 and 13-19.

Dimensioning:

1. All dimensions in inches and millimetres.
Values in brackets are metric equivalents.
2. Charts contain dimensions in inches over millimetres.

Commercial Receptacle Assemblies

No. of Positions	Dimensions				Flow Solder Type Contacts	Solder Eyelet Type Contacts	.010 x .020 [0.25 x 0.51] Posted Contacts	Card Extender Type Contacts
	A	B	C	D	AMP Part No.	AMP Part No.	AMP Part No.	AMP Part No.
110	<u>6.355</u> 161.42	<u>6.065</u> 154.05	54	<u>5.400</u> 137.16	1-583584-6	1-583584-7	2-583584-5	583667-7
100	<u>5.855</u> 148.72	<u>5.565</u> 141.35	49	<u>4.900</u> 124.46	1-583584-3	1-583584-4	2-583584-7	583667-9
90	<u>5.355</u> 136.02	<u>5.065</u> 128.65	44	<u>4.400</u> 111.76	1-583584-0	1-583584-1	2-583584-3	583667-6
80	<u>4.855</u> 123.32	<u>4.565</u> 115.95	39	<u>3.900</u> 99.06	583584-7	583584-8	3-583584-4	583667-8
70	<u>4.355</u> 110.62	<u>4.065</u> 103.25	34	<u>3.400</u> 86.36	2-583584-1	2-583584-9	3-583584-3	583667-5
60	<u>3.855</u> 97.92	<u>3.565</u> 90.55	29	<u>2.900</u> 73.66	583584-4	583584-5	2-583584-2	583667-4
50	<u>3.355</u> 85.22	<u>3.065</u> 77.85	24	<u>2.400</u> 60.96	583584-1	583584-2	3-583584-2	583667-3
40	<u>2.855</u> 72.52	<u>2.565</u> 65.15	19	<u>1.900</u> 48.26	2-583584-0	3-583584-0	3-583584-1	583667-2
30	<u>2.355</u> 59.82	<u>2.065</u> 52.45	14	<u>1.400</u> 35.56	1-583584-9	2-583584-4	2-583584-6	583667-1

Military Receptacle Assemblies

No. of Positions	Dimensions				Flow Solder Type Contacts		Solder Eyelet Type Contacts		.010 x .020 [0.25 x 0.51] Posted Contacts		Card Extender Type Contacts	
	A	B	C	D	MIL-Part No.	AMP Part No.	MIL-Part No.	AMP Part No.	MIL-Part No.	AMP Part No.	MIL-Part No.	AMP Part No.
110	<u>6.355</u> 161.42	<u>6.065</u> 154.05	54	<u>5.400</u> 137.16	M55302/27-21	583707-6	M55302/27-22	583708-6	M55302/27-23	583709-6	M55302/27-24	583710-6
100	<u>5.855</u> 148.72	<u>5.565</u> 141.35	49	<u>4.900</u> 124.46	M55302/27-17	583707-5	M55302/27-18	583708-5	M55302/27-19	583709-5	M55302/27-20	583710-5
90	<u>5.355</u> 136.02	<u>5.065</u> 128.65	44	<u>4.400</u> 111.76	M55302/27-13	583707-4	M55302/27-14	583708-4	M55302/27-15	583709-4	M55302/27-16	583710-4
80	<u>4.855</u> 123.32	<u>4.565</u> 115.95	39	<u>3.900</u> 99.06	M55302/27-09	583707-3	M55302/27-10	583708-3	M55302/27-11	583709-3	M55302/27-12	583710-3
70	<u>4.355</u> 110.62	<u>4.065</u> 103.25	34	<u>3.400</u> 86.36	M55302/27-33	583707-9	M55302/27-34	583708-9	M55302/27-35	583709-9	M55302/27-36	583710-9
60	<u>3.855</u> 97.92	<u>3.565</u> 90.55	29	<u>2.900</u> 73.66	M55302/27-05	583707-2	M55302/27-06	583708-2	M55302/27-07	583709-2	M55302/27-08	583710-2
50	<u>3.355</u> 85.22	<u>3.065</u> 77.85	24	<u>2.400</u> 60.96	M55302/27-01	583707-1	M55302/27-02	583708-1	M55302/27-03	583709-1	M55302/27-04	583710-1
40	<u>2.855</u> 72.52	<u>2.565</u> 65.15	19	<u>1.900</u> 48.26	M55302/27-29	583707-8	M55302/27-30	583708-8	M55302/27-31	583709-8	M55302/27-32	583710-8
30	<u>2.355</u> 59.82	<u>2.065</u> 52.45	14	<u>1.400</u> 35.56	M55302/27-25	583707-7	M55302/27-26	583708-7	M55302/27-27	583709-7	M55302/27-28	583710-7

1000 Series Posted Contact (Wrap-Type) Receptacle Assemblies, Rack Mount

- Dimensioning:**
 1. All dimensions in inches and millimetres.
 Values in brackets are metric equivalents.
 2. Chart contains dimensions in inches over millimetres.

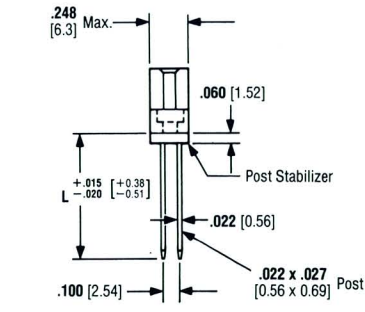
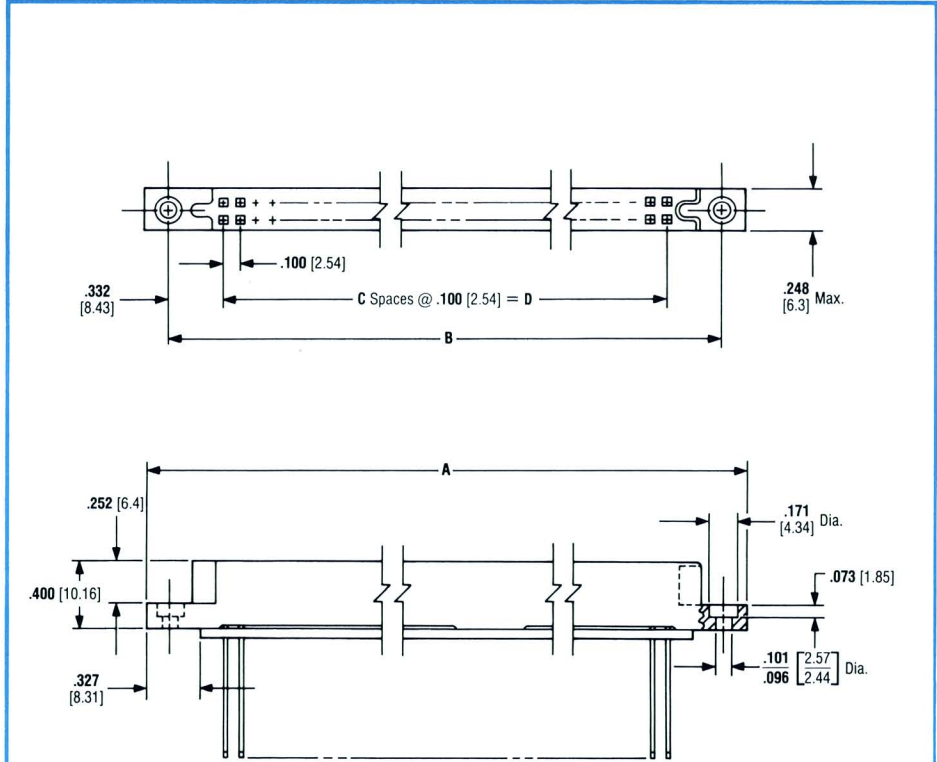

Rack Mount

Post Length	No. of Terminations per Post		
	1 High	2 High	3 High
L	.405 10.29	.565 14.35	.725 18.42

Maximum wire size for wrapping the posted box terminal is #30 AWG [0.05 mm²] (max. insulated wire diameter, .019" [0.49 mm]).

- The following data can be used to determine bit and sleeve size:
- Maximum Terminal Diagonal: .034 [0.87]
 - Minimum Terminal Diagonal: .031 [0.78]
 - Maximum Effective Radius: .067 [1.71]

Recommended Sleeve: No. 507100*
 Recommended Bits: No. 511208*
 No. 507063*

*Available from Gardner-Denver Co., Grand Haven, Michigan.

- Notes:** 1. See page 13-24 for Recommended Pc Board Layout.
 2. These Receptacle Assemblies will mate with the 1000 Series Pin Header Assemblies shown on pages 13-18 and 13-19.

Dimensioning:

1. All dimensions in inches and millimetres. Values in brackets are metric equivalents.
2. Charts contain dimensions in inches over millimetres.

Commercial Receptacle Assemblies, Rack Mount

No. of Positions	Dimensions				No. of Terminations per Post		
	A	B	C	D	1 High	2 High	3 High
					AMP Part No.	AMP Part No.	AMP Part No.
110	<u>6.355</u>	<u>6.065</u>	54	<u>5.400</u>	583847-9	583846-9	583815-9
	161.42	154.05		137.16			
100	<u>5.855</u>	<u>5.565</u>	49	<u>4.900</u>	583847-8	583846-8	583815-8
	148.72	141.35		124.46			
90	<u>5.355</u>	<u>5.065</u>	44	<u>4.400</u>	583847-7	583846-7	583815-7
	136.02	128.65		111.76			
80	<u>4.855</u>	<u>4.565</u>	39	<u>3.900</u>	583847-6	583846-6	583815-6
	123.32	115.95		99.06			
70	<u>4.355</u>	<u>4.065</u>	34	<u>3.400</u>	583847-5	583846-5	583815-5
	110.62	103.25		86.36			
60	<u>3.855</u>	<u>3.565</u>	29	<u>2.900</u>	583847-4	583846-4	583815-4
	97.92	90.55		73.66			
50	<u>3.355</u>	<u>3.065</u>	24	<u>2.400</u>	583847-3	583846-3	583815-3
	85.22	77.85		60.96			
40	<u>2.855</u>	<u>2.565</u>	19	<u>1.900</u>	583847-2	583846-2	583815-2
	72.52	65.15		48.26			
30	<u>2.355</u>	<u>2.065</u>	14	<u>1.400</u>	583847-1	583846-1	583815-1
	59.82	52.45		35.56			

Military Receptacle Assemblies, Rack Mount

No. of Positions	Dimensions				No. of Terminations per Post					
	A	B	C	D	1 High		2 High		3 High	
					MIL-Part No.	AMP Part No.	MIL-Part No.	AMP Part No.	MIL-Part No.	AMP Part No.
110	<u>6.355</u>	<u>6.065</u>	54	<u>5.400</u>	M55302/27-86	530304-9	M55302/27-88	530305-9	M55302/27-90	530306-9
	161.42	154.05		137.16						
100	<u>5.855</u>	<u>5.565</u>	49	<u>4.900</u>	M55302/27-80	530304-8	M55302/27-82	530305-8	M55302/27-84	530306-8
	148.72	141.35		124.46						
90	<u>5.355</u>	<u>5.065</u>	44	<u>4.400</u>	M55302/27-74	530304-7	M55302/27-76	530305-7	M55302/27-78	530306-7
	136.02	128.65		111.76						
80	<u>4.855</u>	<u>4.565</u>	39	<u>3.900</u>	M55302/27-68	530304-6	M55302/27-70	530305-6	M55302/27-72	530306-6
	123.32	115.95		99.06						
70	<u>4.355</u>	<u>4.065</u>	34	<u>3.400</u>	M55302/27-62	530304-5	M55302/27-64	530305-5	M55302/27-66	530306-5
	110.62	103.25		86.36						
60	<u>3.855</u>	<u>3.565</u>	29	<u>2.900</u>	M55302/27-56	530304-4	M55302/27-58	530305-4	M55302/27-60	530306-4
	97.92	90.55		73.66						
50	<u>3.355</u>	<u>3.065</u>	24	<u>2.400</u>	M55302/27-50	530304-3	M55302/27-52	530305-3	M55302/27-54	530306-3
	85.22	77.85		60.96						
40	<u>2.855</u>	<u>2.565</u>	19	<u>1.900</u>	M55302/27-44	530304-2	M55302/27-46	530305-2	M55302/27-48	530306-2
	72.52	65.15		48.26						
30	<u>2.355</u>	<u>2.065</u>	14	<u>1.400</u>	M55302/27-38	530304-1	M55302/27-40	530305-1	M55302/27-42	530306-1
	59.82	52.45		35.56						

Note: Rack Mount Assemblies have "hard-latch" contacts which must be removed from the rear with Extraction Tool No. 91035-1.

1000 Series Posted Contact (Wrap-Type) Receptacle Assemblies, Pc Mount

Dimensioning:

1. All dimensions in inches and millimetres.
2. Values in brackets are metric equivalents.
3. Chart contains dimensions in inches over millimetres.

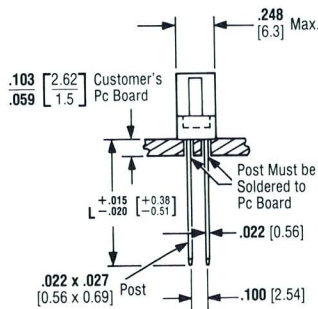
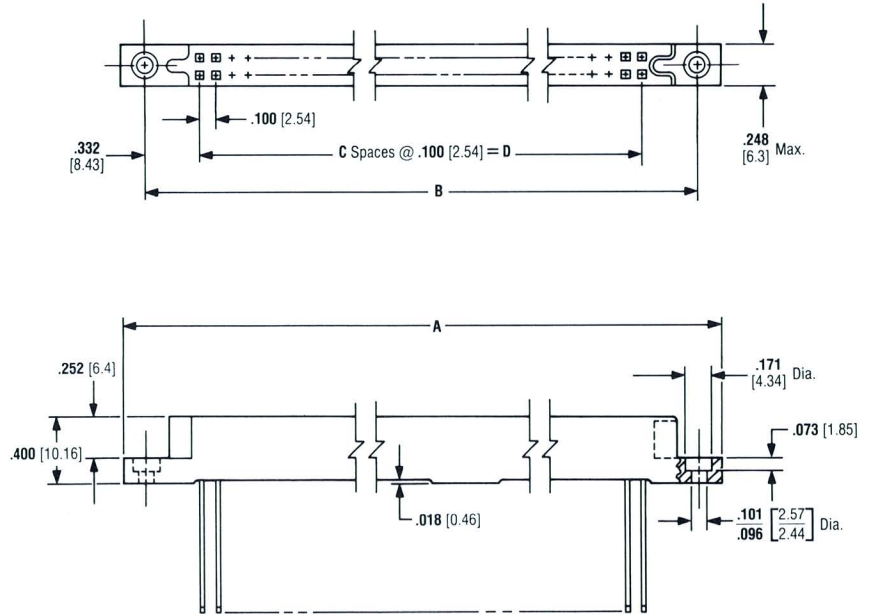

Pc Mount

Post Length	No. of Terminations per Post		
	1 High	2 High	3 High
L	.405 10.29	.565 14.35	.725 18.42

Maximum wire size for wrapping the posted box terminal is #30 AWG [0.05 mm²] (max. insulated wire diameter, .019" [0.49 mm]).

The following data can be used to determine bit and sleeve size:

- Maximum Terminal Diagonal: .034 [0.87]
- Minimum Terminal Diagonal: .031 [0.78]
- Maximum Effective Radius: .067 [1.71]

Recommended Sleeve: No. 507100*
Recommended Bits: No. 511208*
No. 507063*

*Available from Gardner-Denver Co., Grand Haven, Michigan.

- Notes:** 1. See page 13-24 for Recommended Pc Board Layout.
2. These Receptacle Assemblies will mate with the 1000 Series Pin Header Assemblies shown on pages 13-18 and 13-19.

Dimensioning:

1. All dimensions in inches and millimetres.
Values in brackets are metric equivalents.
2. Charts contain dimensions in inches over millimetres.

Commercial Receptacle Assemblies, Pc Mount

No. of Positions	Dimensions				No. of Terminations per Post	
	A	B	C	D	3 High	
					AMP Part No.	
110	<u>6.355</u>	<u>6.065</u>	54	<u>5.400</u>	583814-9	
	161.42	154.05		137.16		
100	<u>5.855</u>	<u>5.565</u>	49	<u>4.900</u>	583814-8	
	148.72	141.35		124.46		
90	<u>5.355</u>	<u>5.065</u>	44	<u>4.400</u>	583814-7	
	136.02	128.65		111.76		
80	<u>4.855</u>	<u>4.565</u>	39	<u>3.900</u>	583814-6	
	123.32	115.95		99.06		
70	<u>4.355</u>	<u>4.065</u>	34	<u>3.400</u>	583814-5	
	110.62	103.25		86.36		
60	<u>3.855</u>	<u>3.565</u>	29	<u>2.900</u>	583814-4	
	97.92	90.55		73.66		
50	<u>3.355</u>	<u>3.065</u>	24	<u>2.400</u>	583814-3	
	85.22	77.85		60.96		
40	<u>2.855</u>	<u>2.565</u>	19	<u>1.900</u>	583814-2	
	72.52	65.15		48.26		
30	<u>2.355</u>	<u>2.065</u>	14	<u>1.400</u>	583814-1	
	59.82	52.45		35.56		

Military Receptacle Assemblies, Pc Mount

No. of Positions	Dimensions				No. of Terminations per Post					
	A	B	C	D	1 High		2 High		3 High	
					MIL-Part No.	AMP Part No.	MIL-Part No.	AMP Part No.	MIL-Part No.	AMP Part No.
110	<u>6.355</u>	<u>6.065</u>	54	<u>5.400</u>	M55302/27-85	530307-9	M55302/27-87	530308-9	M55302/27-89	530309-9
	161.42	154.05		137.16						
100	<u>5.855</u>	<u>5.565</u>	49	<u>4.900</u>	M55302/27-79	530307-8	M55302/27-81	530308-8	M55302/27-83	530309-8
	148.72	141.35		124.46						
90	<u>5.355</u>	<u>5.065</u>	44	<u>4.400</u>	M55302/27-73	530307-7	M55302/27-75	530308-7	M55302/27-77	530309-7
	136.02	128.65		111.76						
80	<u>4.855</u>	<u>4.565</u>	39	<u>3.900</u>	M55302/27-67	530307-6	M55302/27-69	530308-6	M55302/27-71	530309-6
	123.32	115.95		99.06						
70	<u>4.355</u>	<u>4.065</u>	34	<u>3.400</u>	M55302/27-61	530307-5	M55302/27-63	530308-5	M55302/27-65	530309-5
	110.62	103.25		86.36						
60	<u>3.855</u>	<u>3.565</u>	29	<u>2.900</u>	M55302/27-55	530307-4	M55302/27-57	530308-4	M55302/27-59	530309-4
	97.92	90.55		73.66						
50	<u>3.355</u>	<u>3.065</u>	24	<u>2.400</u>	M55302/27-49	530307-3	M55302/27-51	530308-3	M55302/27-53	530309-3
	85.22	77.85		60.96						
40	<u>2.855</u>	<u>2.565</u>	19	<u>1.900</u>	M55302/27-43	530307-2	M55302/27-45	530308-2	M55302/27-47	530309-2
	72.52	65.15		48.26						
30	<u>2.355</u>	<u>2.065</u>	14	<u>1.400</u>	M55302/27-37	530307-1	M55302/27-39	530308-1	M55302/27-41	530309-1
	59.82	52.45		35.56						

Note: Pc Mount Assemblies have "soft-latch" contacts which may be simply pushed out from the rear by hand.

1000 Series Pin Header Assemblies

Dimensioning:
All dimensions in inches and millimetres.
Values in brackets are metric equivalents.

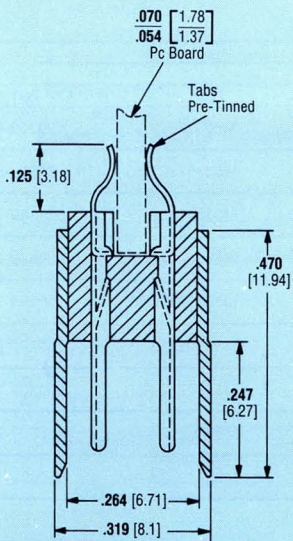
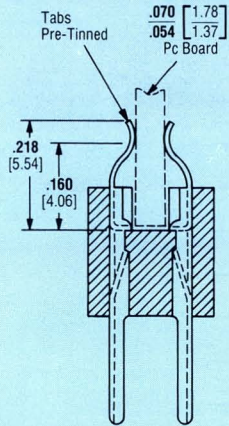

- Notes:**
1. See page 13-25 for Recommended Pc Board Layout.
 2. These Pin Header Assemblies will mate with the 1000 Series Receptacle Assemblies shown on pages 13-12, 13-14 and 13-16.

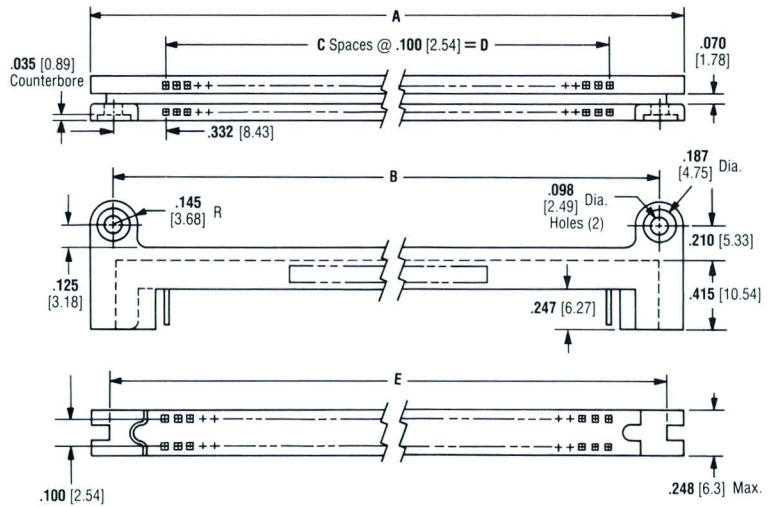

**Style I
(Without Shield)**

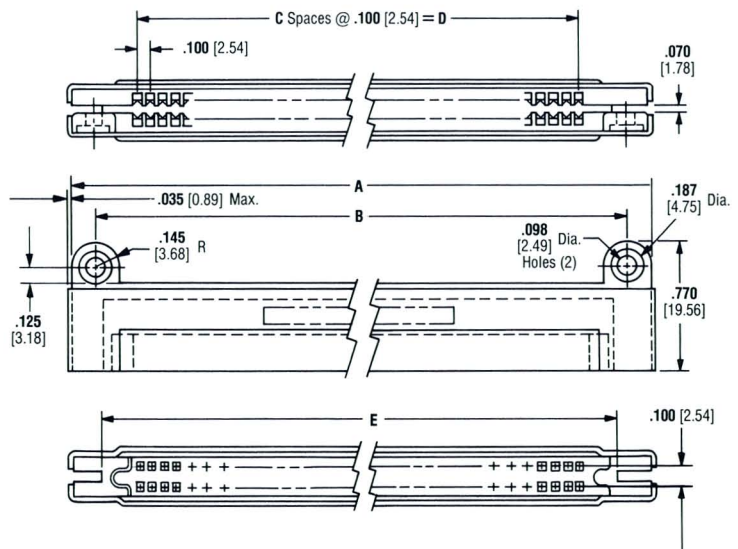

**Style II
(With Shield)**

Dimensioning:

1. All dimensions in inches and millimetres.
Values in brackets are metric equivalents.
2. Charts contain dimensions in inches over millimetres.

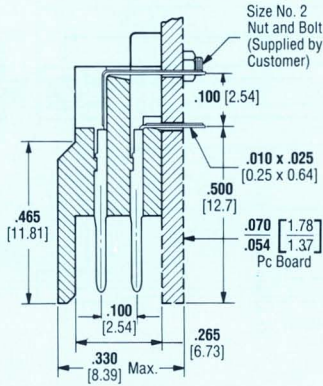

- Notes:**
1. See page 13-25 for Recommended Pc Board Layout.
 2. These Pin Header Assemblies will mate with the 1000 Series Receptacle Assemblies shown on pages 13-12, 13-14 and 13-16.

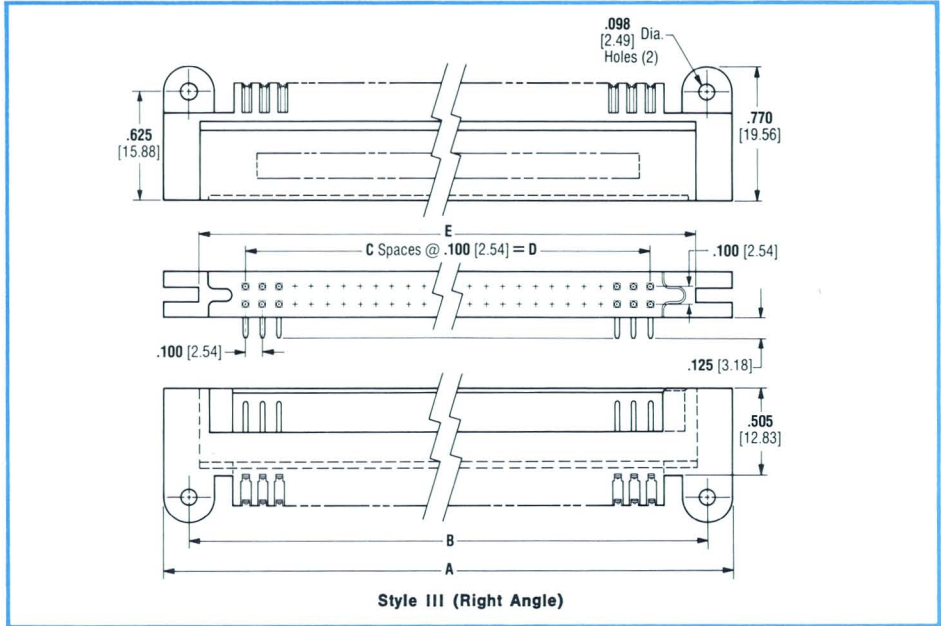

Commercial Pin Header Assemblies

No. of Positions	Dimensions					Style I	Style II	Style III
	A	B	C	D	E	AMP Part No.	AMP Part No.	AMP Part No.
110	6.355 161.42	6.065 154.05	54	5.400 137.16	5.955 151.26	583580-3	583577-3	583849-9
100	5.855 148.72	5.565 141.35	49	4.900 124.46	5.455 138.56	583580-6	583577-6	583849-8
90	5.355 136.02	5.065 128.65	44	4.400 111.76	4.955 125.86	583580-5	583577-5	583849-7
80	4.855 123.32	4.565 115.95	39	3.900 99.06	4.455 113.16	583580-2	583577-2	583849-6
70	4.355 110.62	4.065 103.25	34	3.400 86.36	3.955 100.46	583580-9	583577-7	583849-5
60	3.855 97.92	3.565 90.55	29	2.900 73.66	3.455 87.76	583580-4	583577-4	583849-4
50	3.355 85.22	3.065 77.85	24	2.400 60.96	2.955 75.06	583580-1	583577-1	583849-3
40	2.855 72.52	2.565 65.15	19	1.900 48.26	2.455 62.36	583580-8	583577-8	583849-2
30	2.355 59.82	2.065 52.45	14	1.400 35.56	1.955 49.66	583580-7	583577-9	583849-1

Military Pin Header Assemblies

No. of Positions	Dimensions					Style II, Straddle Mount		Style III, Right Angle Mount	
	A	B	C	D	E	MIL-Part No.	AMP Part No.	MIL-Part No.	AMP Part No.
110	6.355 161.42	6.065 154.05	54	5.400 137.16	5.955 151.26	M55302/26-06	583706-6	M55302/110-09	530336-9
100	5.855 148.72	5.565 141.35	49	4.900 124.46	5.455 138.56	M55302/26-05	583706-5	M55302/110-08	530336-8
90	5.355 136.02	5.065 128.65	44	4.400 111.76	4.955 125.86	M55302/26-04	583706-4	M55302/110-07	530336-7
80	4.855 123.32	4.565 115.95	39	3.900 99.06	4.455 113.16	M55302/26-03	583706-3	M55302/110-06	530336-6
70	4.355 110.62	4.065 103.25	34	3.400 86.36	3.955 100.46	M55302/26-09	583706-9	M55302/110-05	530336-5
60	3.855 97.92	3.565 90.55	29	2.900 73.66	3.455 87.76	M55302/26-02	583706-2	M55302/110-04	530336-4
50	3.355 85.22	3.065 77.85	24	2.400 60.96	2.955 75.06	M55302/26-01	583706-1	M55302/110-03	530336-3
40	2.855 72.52	2.565 65.15	19	1.900 48.26	2.455 62.36	M55302/26-08	583706-8	M55302/110-02	530336-2
30	2.355 59.82	2.065 52.45	14	1.400 35.56	1.955 49.66	M55302/26-07	583706-7	M55302/110-01	530336-1

750 Series Receptacle Assemblies

Dimensioning:
All dimensions in inches and millimetres.
Values in brackets are metric equivalents.

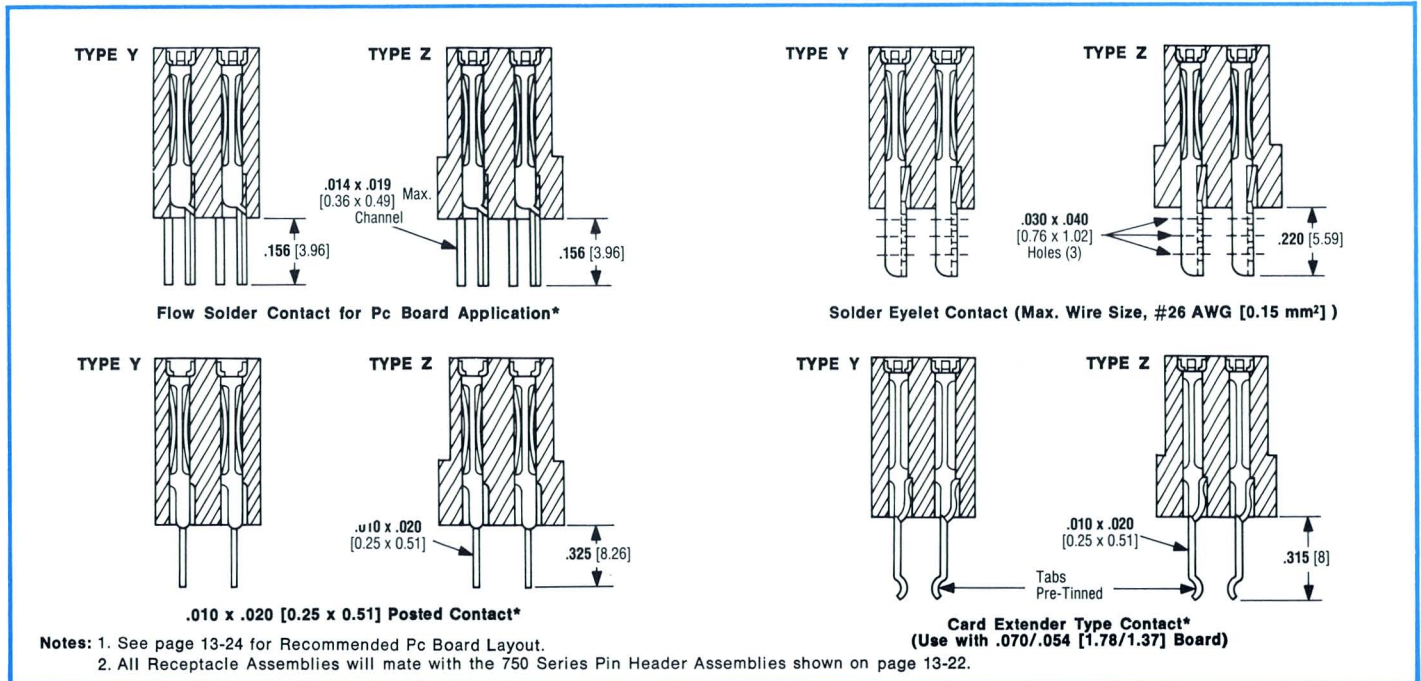
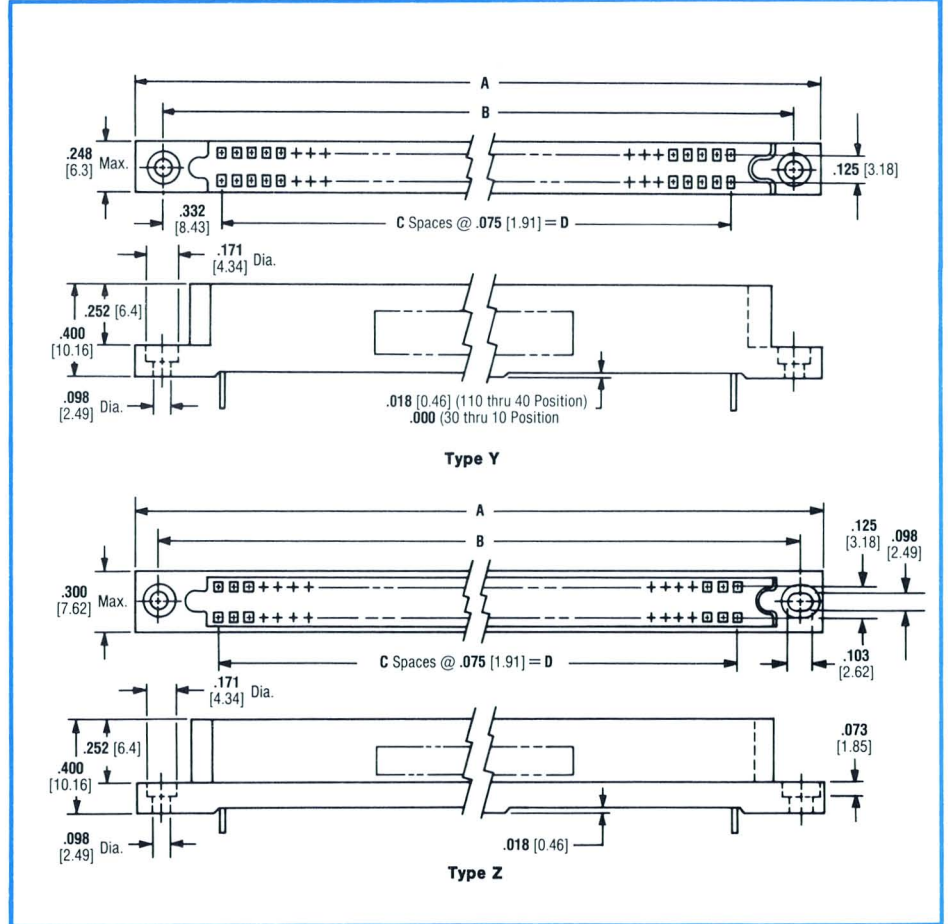

Dimensioning:

1. All dimensions in inches and millimetres. Values in brackets are metric equivalents.
2. Charts contain dimensions in inches over millimetres.

Commercial Receptacle Assemblies

No. of Positions	Housing Type	Dimensions				Flow Solder Type Contacts AMP Part No.	Solder Eyelet Type Contacts AMP Part No.	.010 x .020 [0.25 x 0.51] Posted Contacts AMP Part No.	Card Extender Type Contacts AMP Part No.
		A	B	C	D				
180	Z	<u>7.630</u>	<u>7.340</u>	89	<u>6.675</u>	583247-2	583247-5	4-583292-0	583247-8
		193.8	186.44		169.55				
160	Z	<u>6.880</u>	<u>6.590</u>	79	<u>5.925</u>	1-583247-4	1-583247-1	3-583292-5	583247-9
		174.75	167.39		150.5				
150	Z	<u>6.505</u>	<u>6.215</u>	74	<u>5.550</u>	583247-3	583247-6	2-583292-2	583247-7
		165.23	157.86		140.97				
120	Z	<u>5.380</u>	<u>5.090</u>	59	<u>4.425</u>	583247-1	583247-4	1-583292-6	1-583247-0
		136.65	129.29		112.4				
110	Y	<u>5.005</u>	<u>4.715</u>	54	<u>4.050</u>	1-202844-2	3-202844-6	1-583292-8	2-202844-5
		127.13	119.76		102.87				
100	Y	<u>4.630</u>	<u>4.340</u>	49	<u>3.675</u>	202844-1	1-202844-5	1-583292-7	2-202844-0
		117.6	110.24		93.35				
90	Y	<u>4.255</u>	<u>3.965</u>	44	<u>3.300</u>	1-202844-1	3-202844-5	2-583292-6	4-202844-1
		108.08	100.71		83.82				
80	Y	<u>3.880</u>	<u>3.590</u>	39	<u>2.925</u>	1-202844-0	1-202844-7	2-583292-7	1-202844-9
		98.55	91.19		74.3				
70	Y	<u>3.505</u>	<u>3.215</u>	34	<u>2.550</u>	202844-9	3-202844-4	2-583292-5	4-202844-5
		89.03	81.66		64.77				
60	Y	<u>3.130</u>	<u>2.840</u>	29	<u>2.175</u>	202844-8	3-202844-1	2-583292-9	2-202844-8
		79.5	72.14		55.25				
50	Y	<u>2.755</u>	<u>2.465</u>	24	<u>1.800</u>	202844-7	2-202844-4	3-583292-9	1-202844-8
		69.98	62.61		45.72				
40	Y	<u>2.380</u>	<u>2.090</u>	19	<u>1.425</u>	202844-6	3-202844-0	3-583292-8	2-202844-7
		60.45	53.09		36.2				
30	Y	<u>2.005</u>	<u>1.715</u>	14	<u>1.050</u>	202844-5	2-202844-3	3-583292-7	2-202844-2
		50.93	43.56		26.67				
20	Y	<u>1.630</u>	<u>1.340</u>	9	<u>.675</u>	202844-4	2-202844-9	2-583292-8	2-202844-6
		41.4	34.04		17.15				
10	Y	<u>1.225</u>	<u>.965</u>	4	<u>.300</u>	1-202844-6	3-202844-3	3-583292-6	4-202844-6
		31.12	24.51		7.62				

Military Receptacle Assemblies

No. of Positions	Housing Type	Dimensions				Flow Solder Type Contacts		Solder Eyelet Type Contacts		.010 x .020 [0.25 x 0.51] Posted Contacts		Card Extender Type Contacts	
		A	B	C	D	MIL-Part No.	AMP Part No.	MIL-Part No.	AMP Part No.	MIL-Part No.	AMP Part No.	MIL-Part No.	AMP Part No.
180	Z	<u>7.630</u>	<u>7.340</u>	89	<u>6.675</u>	M55302/25-13	583702-4	M55302/25-14	583703-4	M55302/25-15	583704-4	M55302/25-16	583705-4
		193.8	186.44		169.55								
160	Z	<u>6.880</u>	<u>6.590</u>	79	<u>5.925</u>	M55302/25-09	583702-3	M55302/25-10	583703-3	M55302/25-11	583704-3	M55302/25-12	583705-3
		174.75	167.39		150.5								
150	Z	<u>6.505</u>	<u>6.215</u>	74	<u>5.550</u>	M55302/25-05	583702-2	M55302/25-06	583703-2	M55302/25-07	583704-2	M55302/25-08	583705-2
		165.23	157.86		140.97								
120	Z	<u>5.380</u>	<u>5.090</u>	59	<u>4.425</u>	M55302/25-01	583702-1	M55302/25-02	583703-1	M55302/25-03	583704-1	M55302/25-04	583705-1
		136.65	129.29		112.4								
110	Y	<u>5.005</u>	<u>4.715</u>	54	<u>4.050</u>	M55302/24-41	1-583698-1	M55302/24-42	1-583699-1	M55302/24-43	1-583700-1	M55302/24-44	1-583701-1
		127.13	119.76		102.87								
100	Y	<u>4.630</u>	<u>4.340</u>	49	<u>3.675</u>	M55302/24-37	1-583698-0	M55302/24-38	1-583699-0	M55302/24-39	1-583700-0	M55302/24-40	1-583701-0
		117.6	110.24		93.35								
90	Y	<u>4.255</u>	<u>3.965</u>	44	<u>3.300</u>	M55302/24-33	583698-9	M55302/24-34	583699-9	M55302/24-35	583700-9	M55302/24-36	583701-9
		108.08	100.71		83.82								
80	Y	<u>3.880</u>	<u>3.590</u>	39	<u>2.925</u>	M55302/24-29	583698-8	M55302/24-30	583699-8	M55302/24-31	583700-8	M55302/24-32	583701-8
		98.55	91.19		74.3								
70	Y	<u>3.505</u>	<u>3.215</u>	34	<u>2.550</u>	M55302/24-25	583698-7	M55302/24-26	583699-7	M55302/24-27	583700-7	M55302/24-28	583701-7
		89.03	81.66		64.77								
60	Y	<u>3.130</u>	<u>2.840</u>	29	<u>2.175</u>	M55302/24-21	583698-6	M55302/24-22	583699-6	M55302/24-23	583700-6	M55302/24-24	583701-6
		79.5	72.14		55.25								
50	Y	<u>2.755</u>	<u>2.465</u>	24	<u>1.800</u>	M55302/24-17	583698-5	M55302/24-18	583699-5	M55302/24-19	583700-5	M55302/24-20	583701-5
		69.98	62.61		45.72								
40	Y	<u>2.380</u>	<u>2.090</u>	19	<u>1.425</u>	M55302/24-13	583698-4	M55302/24-14	583699-4	M55302/24-15	583700-4	M55302/24-16	583701-4
		60.45	53.09		36.2								
30	Y	<u>2.005</u>	<u>1.715</u>	14	<u>1.050</u>	M55302/24-09	583698-3	M55302/24-10	583699-3	M55302/24-11	583700-3	M55302/24-12	583701-3
		50.93	43.56		26.67								
20	Y	<u>1.630</u>	<u>1.340</u>	9	<u>.675</u>	M55302/24-05	583698-2	M55302/24-06	583699-2	M55302/24-07	583700-2	M55302/24-08	583701-2
		41.4	34.04		17.15								
10	Y	<u>1.225</u>	<u>.965</u>	4	<u>.300</u>	M55302/24-01	583698-1	M55302/24-02	583699-1	M55302/24-03	583700-1	M55302/24-04	583701-1
		31.12	24.51		7.62								

750 Series Pin Header Assemblies

Dimensioning:
All dimensions in inches and millimetres.
Values in brackets are metric equivalents.

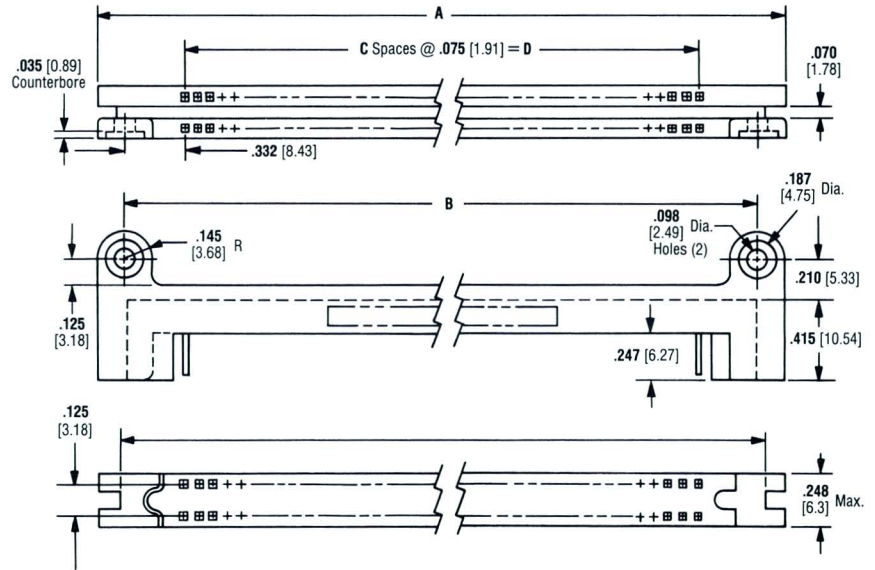
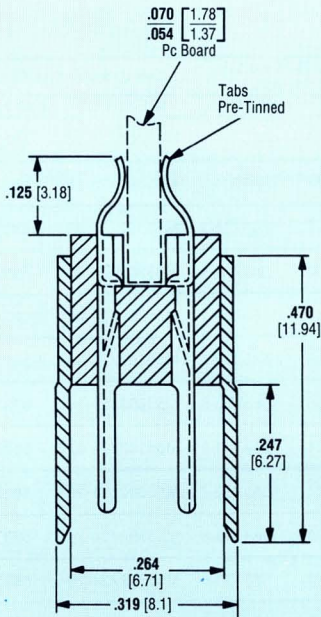
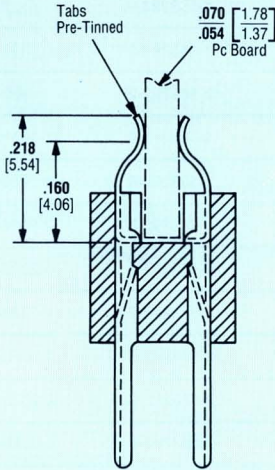

**Style I
(Without Shield)**

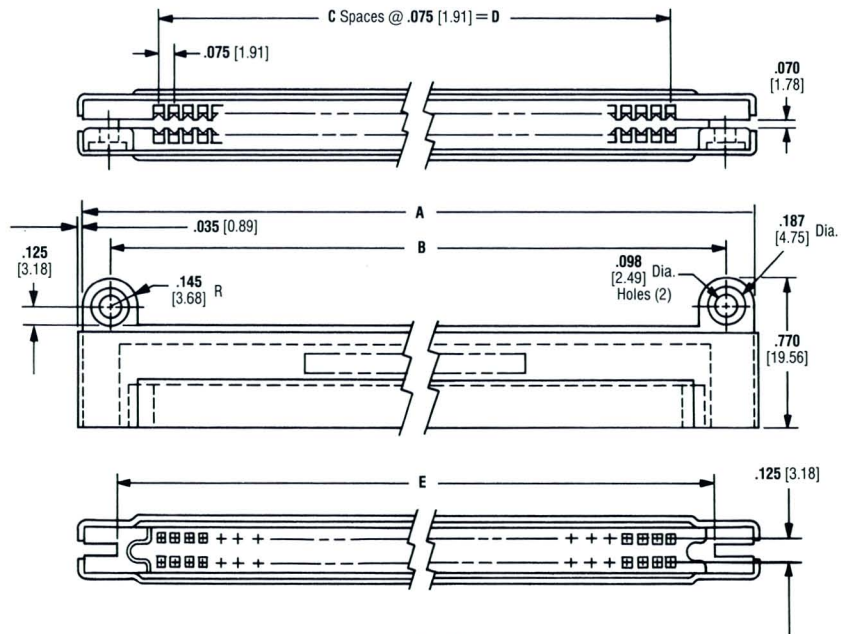

**Style II
(With Shield)**

Notes: 1. See page 13-25 for Recommended Pc Board Layout.
2. These Pin Header Assemblies will mate with the 750 Series Receptacle Assemblies shown on page 13-20.

Dimensioning:

1. All dimensions in inches and millimetres. Values in brackets are metric equivalents.
2. Charts contain dimensions in inches over millimetres.

Commercial Pin Header Assemblies

No. of Positions	Dimensions					Style I	Style II
	A	B	C	D	E	AMP Part Number	AMP Part Number
180	7.630	7.340	89	6.675	7.230	—	583245-2
	193.8	186.44		169.55	183.64		
160	6.880	6.590	79	5.925	6.480	—	583245-8
	174.75	167.39		150.5	164.59		
150	6.505	6.215	74	5.550	6.105	—	583245-4
	165.23	157.86		140.97	155.07		
120	5.380	5.090	59	4.425	4.980	1-202845-7	583245-1
	136.65	129.29		112.4	126.49		
110	5.005	4.715	54	4.050	4.605	1-202845-6	583245-9
	127.13	119.76		102.87	116.97		
100	4.630	4.340	49	3.675	4.230	202845-1	583245-6
	117.6	110.24		93.35	107.44		
90	4.255	3.965	44	3.300	3.855	1-202845-5	1-583245-2
	108.08	100.71		83.82	97.92		
80	3.880	3.590	39	2.925	3.480	1-202845-4	583245-3
	98.55	91.19		74.3	88.39		
70	3.505	3.215	34	2.550	3.105	1-202845-3	1-583245-3
	89.03	81.66		64.77	78.87		
60	3.130	2.840	29	2.175	2.730	1-202845-2	1-583245-0
	79.5	72.14		55.25	69.34		
50	2.755	2.465	24	1.800	2.355	1-202845-1	583245-5
	69.98	62.61		45.72	59.82		
40	2.380	2.090	19	1.425	1.980	1-202845-0	1-583245-1
	60.45	53.09		36.2	50.29		
30	2.005	1.715	14	1.050	1.605	202845-9	583245-7
	50.93	43.56		26.67	40.77		
20	1.630	1.340	9	.675	1.230	202845-8	1-583245-4
	41.4	34.04		17.15	31.24		
10	1.225	.965	4	.300	.855	202845-7	1-583245-5
	31.12	24.51		7.62	21.72		

Military Pin Header Assemblies

No. of Positions	Dimensions					Style II	
	A	B	C	D	E	MIL-Part No.	AMP Part No.
180	7.630	7.340	89	6.675	7.230	M55302/23-15	1-583697-5
	193.8	186.44		169.55	183.64		
160	6.880	6.590	79	5.925	6.480	M55302/23-14	1-583697-4
	174.75	167.39		150.5	164.59		
150	6.505	6.215	74	5.550	6.105	M55302/23-13	1-583697-3
	165.23	157.86		140.97	155.07		
120	5.380	5.090	59	4.425	4.980	M55302/23-12	1-583697-2
	136.65	129.29		112.4	126.49		
110	5.005	4.715	54	4.050	4.605	M55302/23-11	1-583697-1
	127.13	119.76		102.87	116.97		
100	4.630	4.340	49	3.675	4.230	M55302/23-10	1-583697-0
	117.6	110.24		93.35	107.44		
90	4.255	3.965	44	3.300	3.855	M55302/23-09	583697-9
	108.08	100.71		83.82	97.92		
80	3.880	3.590	39	2.925	3.480	M55302/23-08	583697-8
	98.55	91.19		74.3	88.39		
70	3.505	3.215	34	2.550	3.105	M55302/23-07	583697-7
	89.03	81.66		64.77	78.87		
60	3.130	2.840	29	2.175	2.730	M55302/23-06	583697-6
	79.5	72.14		55.25	69.34		
50	2.755	2.465	24	1.800	2.355	M55302/23-05	583697-5
	69.98	62.61		45.72	59.82		
40	2.380	2.090	19	1.425	1.980	M55302/23-04	583697-4
	60.45	53.09		36.2	50.29		
30	2.005	1.715	14	1.050	1.605	M55302/23-03	583697-3
	50.93	43.56		26.67	40.77		
20	1.630	1.340	9	.675	1.230	M55302/23-02	583697-2
	41.4	34.04		17.15	31.24		
10	1.225	.965	4	.300	.855	M55302/23-01	583697-1
	31.12	24.51		7.62	21.72		

Recommended Pc Board Layout for 1000 and 750 Series Receptacle Assemblies

Dimensioning:

1. All dimensions in inches and millimetres. Values in brackets are metric equivalents.
2. Charts contain dimensions in inches over millimetres.

1000 Series Receptacle Assemblies

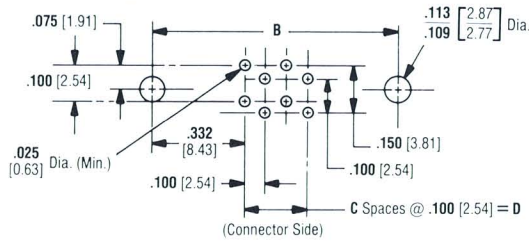

Flow Solder Type Contacts

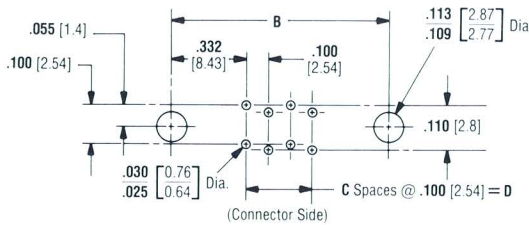

.010 x .020 [0.25 x 0.51] Posted Contacts

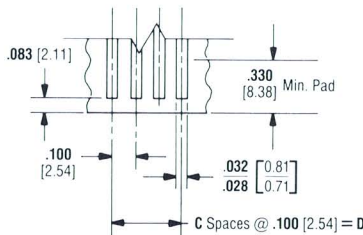

Card Extender Type Contacts

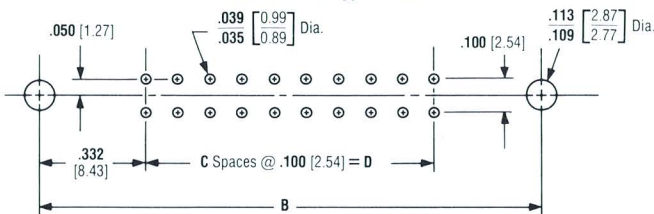

.022 x .027 [0.56 x 0.69] Posted Contacts

No. of Positions	Dimensions			
	A*	B	C	D
110	6.355	6.065	54	5.400
	161.42	154.05		137.16
100	5.855	5.565	49	4.900
	148.72	141.35		124.46
90	5.355	5.065	44	4.400
	136.02	128.65		111.76
80	4.855	4.565	39	3.900
	123.32	115.95		99.06
70	4.355	4.065	34	3.400
	110.62	103.25		86.36
60	3.855	3.565	29	2.900
	97.92	90.55		73.66
50	3.355	3.065	24	2.400
	85.22	77.85		60.96
40	2.855	2.565	19	1.900
	72.52	65.15		48.26
30	2.355	2.065	14	1.400
	59.82	52.45		35.56

* Overall length of receptacle.

750 Series Receptacle Assemblies

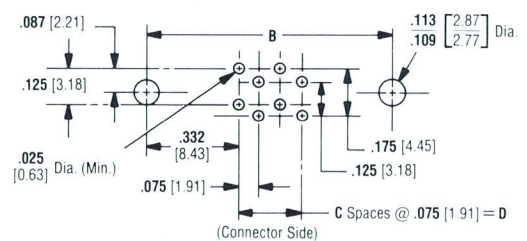

Flow Solder Type Contacts

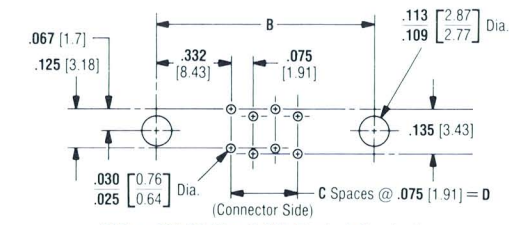

.010 x .020 [0.25 x 0.51] Posted Contacts

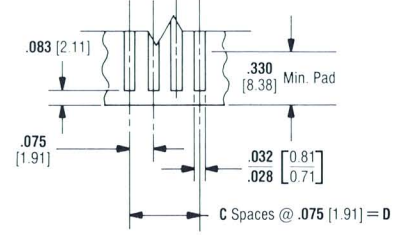

Card Extender Type Contacts

No. of Positions	Dimensions			
	A*	B	C	D
180	7.630	7.340	89	6.675
	193.8	186.44		169.55
160	6.880	6.590	79	5.925
	174.75	167.39		150.5
150	6.505	6.215	74	5.550
	165.23	157.86		140.97
120	5.380	5.090	59	4.425
	136.65	129.29		112.4
110	5.005	4.715	54	4.050
	127.13	119.76		102.87
100	4.630	4.340	49	3.675
	117.6	110.24		93.35
90	4.255	3.965	44	3.300
	108.08	100.71		83.82
80	3.880	3.590	39	2.925
	98.55	91.19		74.3
70	3.505	3.215	34	2.550
	89.03	81.66		64.77
60	3.130	2.840	29	2.175
	79.5	72.14		55.25
50	2.755	2.465	24	1.800
	69.98	62.61		45.72
40	2.380	2.090	19	1.425
	60.45	53.09		36.2
30	2.005	1.715	14	1.050
	50.93	43.56		26.67
20	1.630	1.340	9	.675
	41.4	34.04		17.15
10	1.225	.965	4	.300
	31.12	24.51		7.62

* Overall length of receptacle.

Recommended Pc Board Layout for 1000 and 750 Series Pin Header Assemblies

Dimensioning:

1. All dimensions in inches and millimetres. Values in brackets are metric equivalents.
2. Charts contain dimensions in inches over millimetres.

1000 Series Pin Header Assemblies

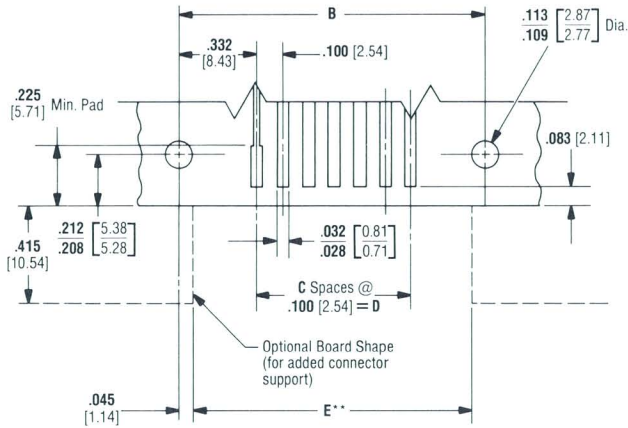

Styles I and II

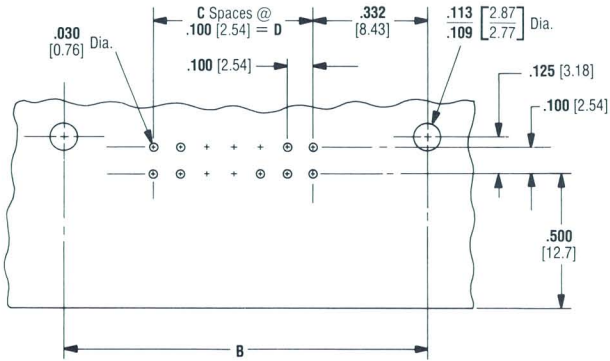

Style III

No. of Positions	Dimensions				
	A*	B	C	D	E**
110	6.355 161.42	6.065 154.05	54	5.400 137.16	5.970 151.64
100	5.855 148.72	5.565 141.35	49	4.900 124.46	5.470 138.94
90	5.355 136.02	5.065 128.65	44	4.400 111.76	4.970 126.24
80	4.855 123.32	4.565 115.95	39	3.900 99.06	4.470 113.54
70	4.355 110.62	4.065 103.25	34	3.400 86.36	3.970 100.84
60	3.855 97.92	3.565 90.55	29	2.900 73.66	3.470 88.14
50	3.355 85.22	3.065 77.85	24	2.400 60.96	2.970 75.44
40	2.855 72.52	2.565 65.15	19	1.900 48.26	2.470 62.74
30	2.355 59.82	2.065 52.45	14	1.400 35.56	1.970 50.04

*Overall length of pin header.
**Board cut-out dimension.

750 Series Pin Header Assemblies

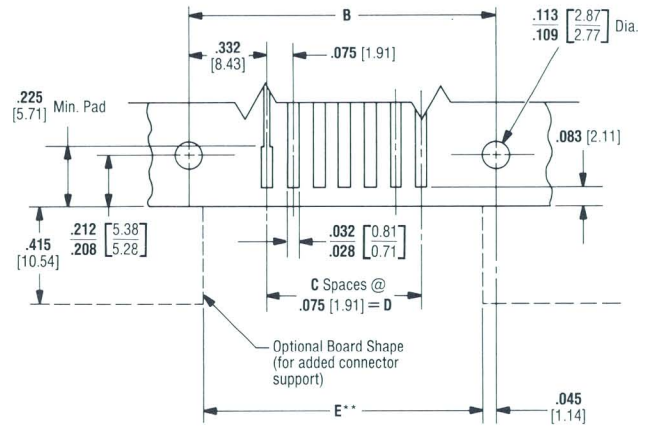

Styles I and II

No. of Positions	Dimensions				
	A*	B	C	D	E**
180	7.630 193.8	7.340 186.44	89	6.675 169.55	7.250 184.15
160	6.880 174.75	6.590 167.39	79	5.925 150.5	6.500 165.1
150	6.505 165.23	6.215 157.86	74	5.550 140.97	6.125 155.58
120	5.380 136.65	5.090 129.29	59	4.425 112.4	4.995 126.87
110	5.005 127.13	4.715 119.76	54	4.050 102.87	4.620 117.35
100	4.630 117.6	4.340 110.24	49	3.675 93.35	4.245 107.82
90	4.255 108.08	3.965 100.71	44	3.300 83.82	3.870 98.3
80	3.880 98.55	3.590 91.19	39	2.925 74.3	3.495 88.77
70	3.505 89.03	3.215 81.66	34	2.550 64.77	3.120 79.25
60	3.130 79.5	2.840 72.14	29	2.175 55.25	2.745 69.72
50	2.755 69.98	2.465 62.61	24	1.800 45.72	2.370 60.2
40	2.380 60.45	2.090 53.09	19	1.425 36.2	1.995 50.67
30	2.005 50.93	1.715 43.56	14	1.050 26.67	1.620 41.15
20	1.630 41.4	1.340 34.04	9	.675 17.15	1.245 31.62
10	1.225 31.12	.965 24.51	4	.300 7.62	.870 22.1

*Overall length of pin header.
**Board cut-out dimension.

500 Series Receptacle Assemblies

Dimensioning:
All dimensions in inches and millimetres.
Values in brackets are metric equivalents.

77 Position, .100" [2.54 mm] Staggered Centers

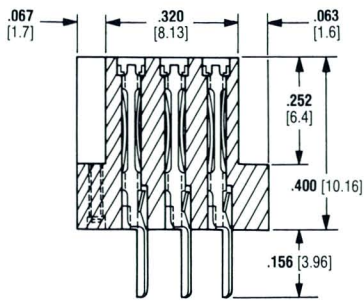
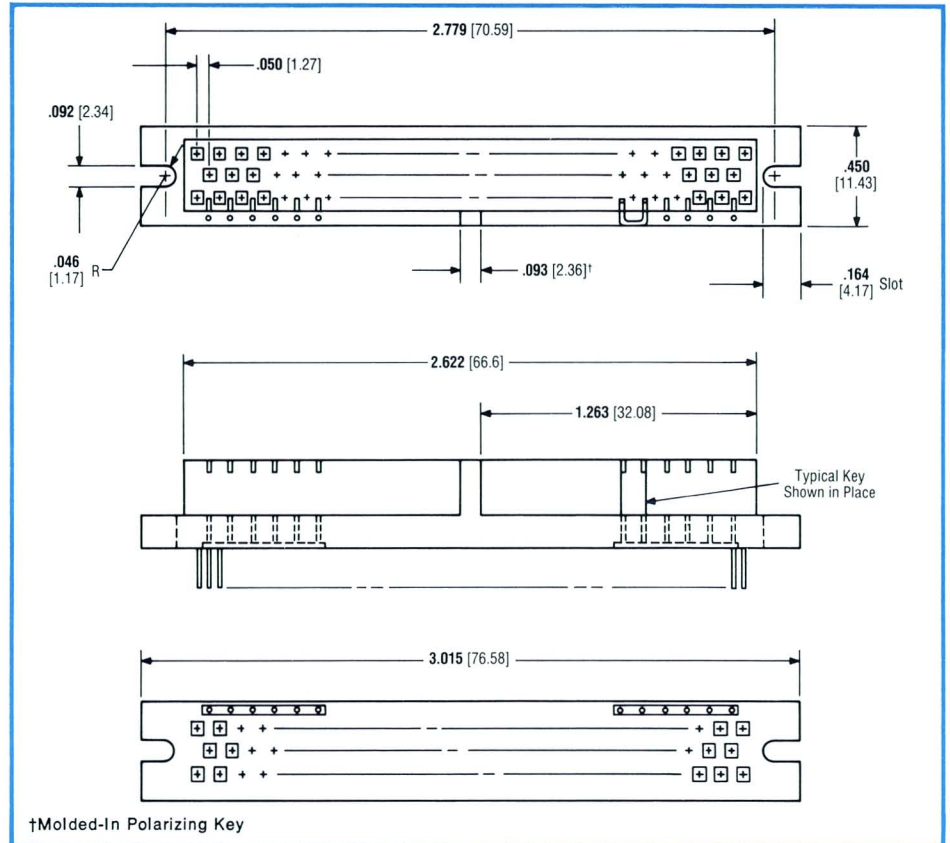

**Flow Solder Contact
for Pc Board Application***

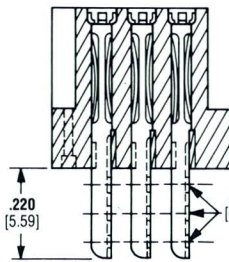

**Solder Eyelet Contact (Max. Wire
Size, #26 AWG [0.15 mm²])**

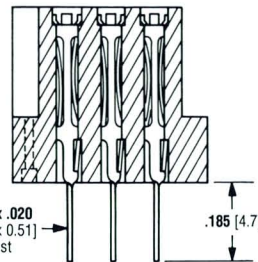

**.010 x .020 [0.25 x 0.51]
Posted Contact***

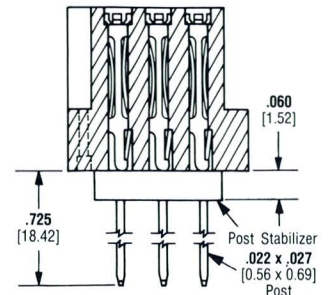

**Posted Box Contact (Wrap-Type),
3 High Rack Mount***

*See page 13-29 for Recommended Pc Board Layout.

Refer to page 13-14 for wrapping information.

- Notes:** 1. All dimensions shown for Flow Solder Type Contact above, except dimension .156 [3.96], are applicable to all other contact types.
2. All Receptacle Assemblies will mate with the 77 position 500 Series Pin Header Assembly shown on page 13-28.

No. of Positions	Flow Solder Type Contacts No. 202946-1	Solder Eyelet Type Contacts No. 583218-1	.010 x .020 [0.25 x 0.51] Posted Contacts No. 583452-5	Posted Box Contacts (3 High Rack Mount) No. 1-583812-8
77	583811-1	583227-1	583807-1	583807-2

Dimensioning:

1. All dimensions in inches and millimetres. Values in brackets are metric equivalents.
2. Chart contains dimensions in inches over millimetres.

**71 & 41 Positions,
.100" [2.54 mm]
Staggered Centers**

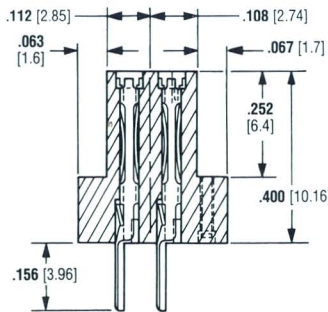
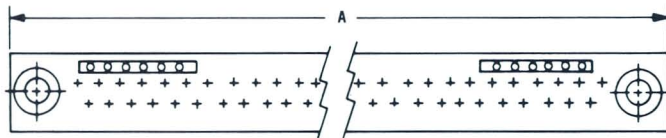
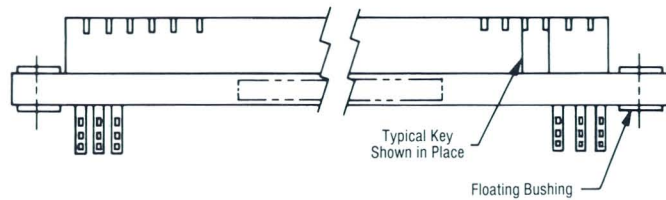
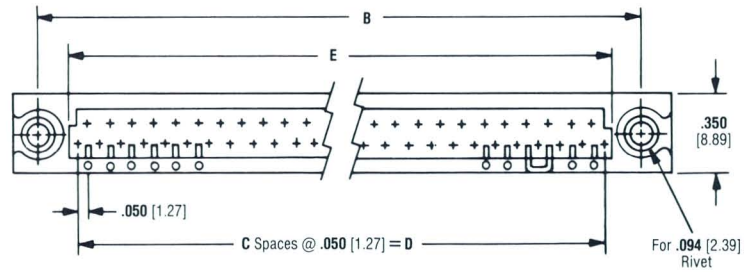

**Flow Solder Contact
for Pc Board Application***

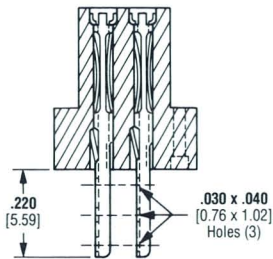

**Solder Eylet Contact (Max. Wire
Size, #26 AWG [0.15 mm²])**

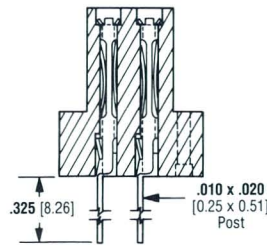

**.010 x .020 [0.25 x 0.51]
Posted Contact***

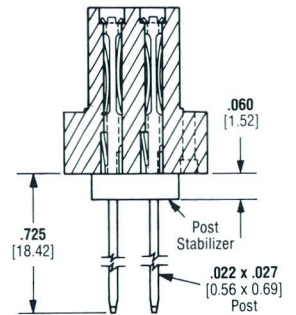

**Posted Box Contact (Wrap-Type),
3 High Rack Mount***

*See page 13-29 for Recommended Pc Board Layout.

Refer to page 13-14 for wrapping information.

- Notes:** 1. All dimensions shown for Flow Solder Type Contact above, except dimension .156 [3.96], are applicable to all other contact types.
2. All Receptacle Assemblies will mate with the 71 and 41 position 500 Series Pin Header Assemblies shown on page 13-28.

No. of Positions	Dimensions					Flow Solder Type Contacts No. 202946-1	Solder Eylet Type Contacts No. 583218-1	.010 x .020 [0.25 x 0.51] Posted Contacts No. 583452-4	Posted Box Contacts (3 High Rack Mount) No. 1-583812-8
	A	B	C	D	E				
71	4.115	3.870	70	3.500	3.625	202932-5	202932-1	1-202932-3	1-202932-5
	104.52	98.3		88.9	92.08				
41	2.615	2.370	40	2.000	2.125	202932-6	202932-2	1-202932-4	1-202932-6
	66.42	60.2		50.8	53.98				

500 Series Pin Header Assemblies

Dimensioning:

1. All dimensions in inches and millimetres. Values in brackets are metric equivalents.
2. Chart contains dimensions in inches over millimetres.

77 Position, .100" [2.54 mm] Staggered Centers

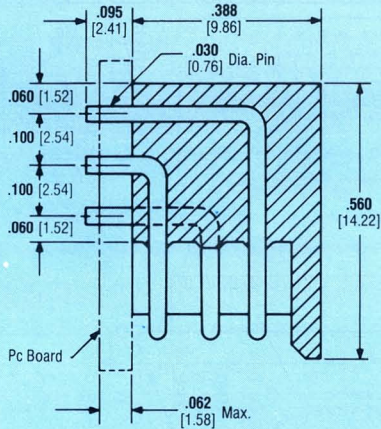

71 & 41 Position, .100" [2.54 mm] Staggered Centers

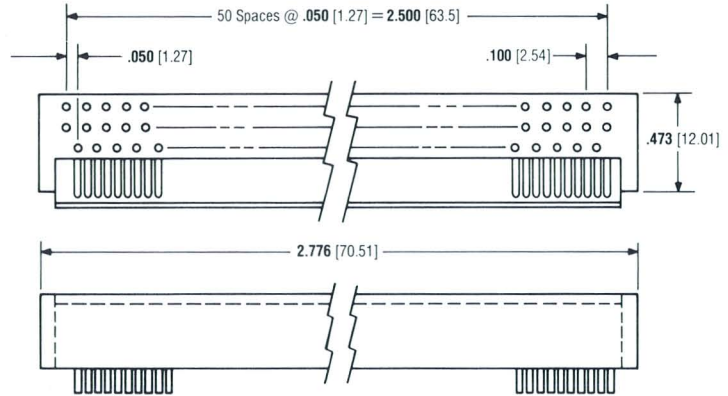
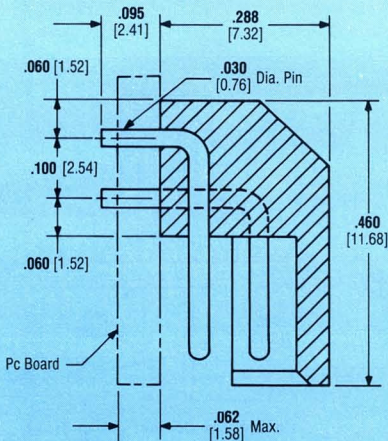

Contact Plating: .000060" [0.0015 mm] minimum gold over
.000050" [0.0013 mm] minimum nickel
Pin Header Assembly Part No. 583226-1

- Notes:** 1. See page 13-29 for Recommended Pc Board Layout.
2. This Pin Header Assembly will mate with the 77 position 500 Series Receptacle Assembly shown on page 13-26.

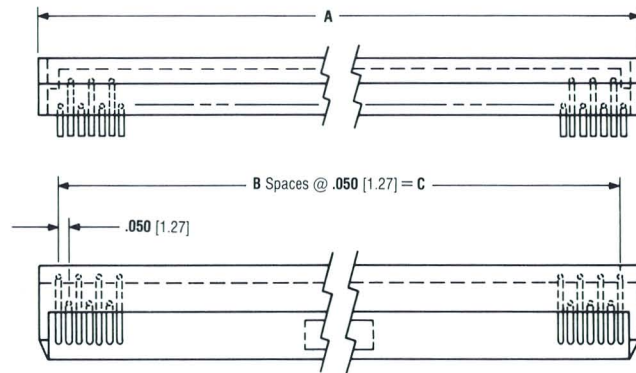

Contact Plating: .000060" [0.0015 mm] minimum gold over
.000050" [0.0013 mm] minimum nickel

- Notes:** 1. See page 13-29 for Recommended Pc Board Layout.
2. These Pin Header Assemblies will mate with the 71 and 41 position 500 Series Receptacle Assemblies shown on page 13-27.

No. of Positions	Dimensions			Part Number
	A	B	C	
71	3.776	70	3.500	202933-1
	95.91		88.9	
41	2.276	40	2.000	202933-2
	57.81		50.8	

Recommended Pc Board Layout for 500 Series Connectors

Dimensioning:

1. All dimensions in inches and millimetres. Values in brackets are metric equivalents.
2. Chart contains dimensions in inches over millimetres.

Receptacle Assemblies

Contact Type	Dimensions		
	X	Y	Z
.010 x .020 0.25 x 0.51 Post	.050 1.27	.030 0.76	.100 2.54
Flow Solder	.025 0.64	.025 0.64	.075 1.91
Posted Box	.050 1.27	.040 1.02	.100 2.54

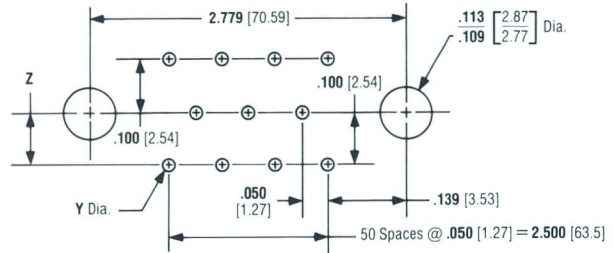

77 Position Receptacle Assembly

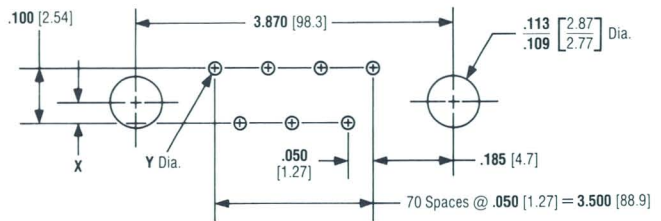

71 Position Receptacle Assembly

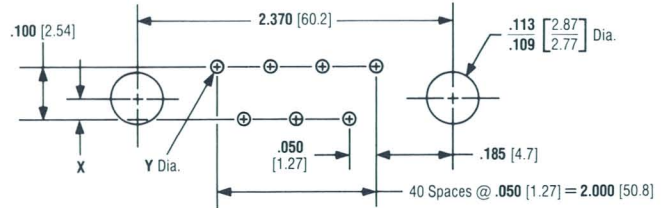

41 Position Receptacle Assembly

Pin Header Assemblies

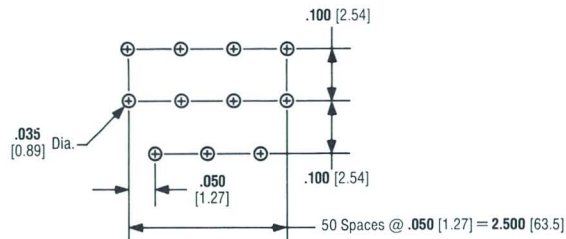

77 Position Pin Header Assembly

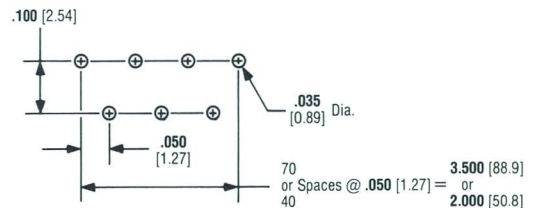

71 & 41 Position Pin Header Assemblies

Keying Methods for 1000, 750 and 500 Series Connectors

1000 and 750 Series Connectors (See AMP Instruction Sheet No. IS 7328.)

1000 and 750 Series connectors may be keyed by one of two methods: the "keying sleeve" or the recently designed "solid keying pin." The solid keying pin is recommended for keying the 1000 and 750 Series connectors. However, the keying sleeve will remain available for customers using this method.

Also, it should be noted that the two keying methods are inter-mateable, with one exception: receptacles with a contact removed (but not reamed to .062 [1.57] dia.) will mate with pin headers having a solid keying pin but will not mate with pin headers that are equipped with the keying sleeve.

Solid Keying Pin

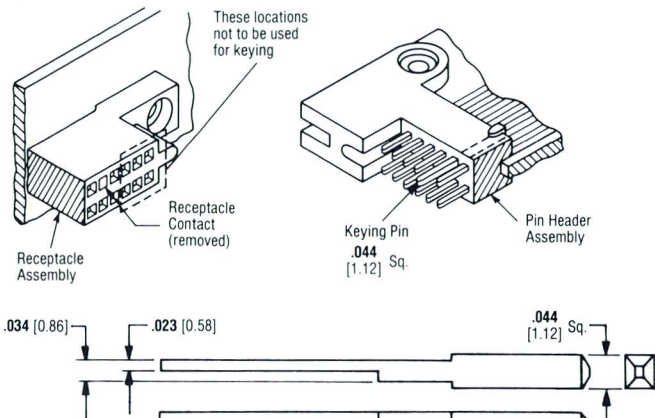

- Assembly Instructions:
1. Remove pin and receptacle from desired keying locations.
 2. Insert keying pin in pin header, secure by bending rear of pin over outside edge of housing, and trim excess material.

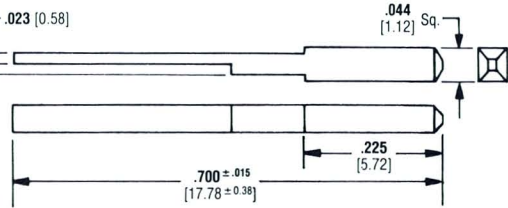

Material: Nickel plated brass
AMP Part No. 530328-2
MIL-Part No. M55302/31-03

Keying Sleeve

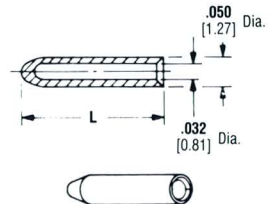
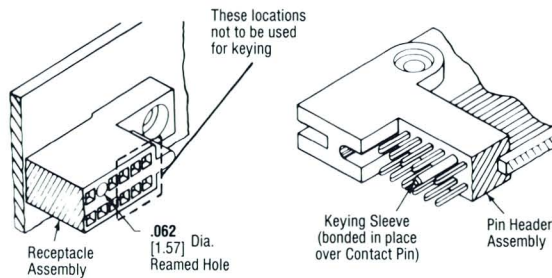

Material: Nickel plated brass

L	MIL-Part No.	AMP Part No.
.305 7.75	M55302/31-01	583254-3
.250 6.35	M55302/31-02	583254-4

500 Series Connectors (See AMP Instruction Sheet Nos. IS 7329 and IS 7335.)

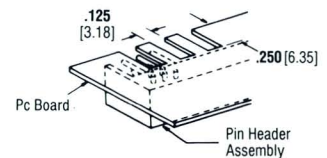
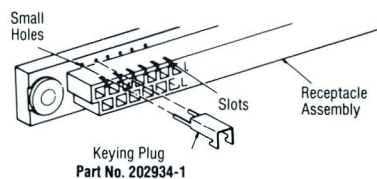

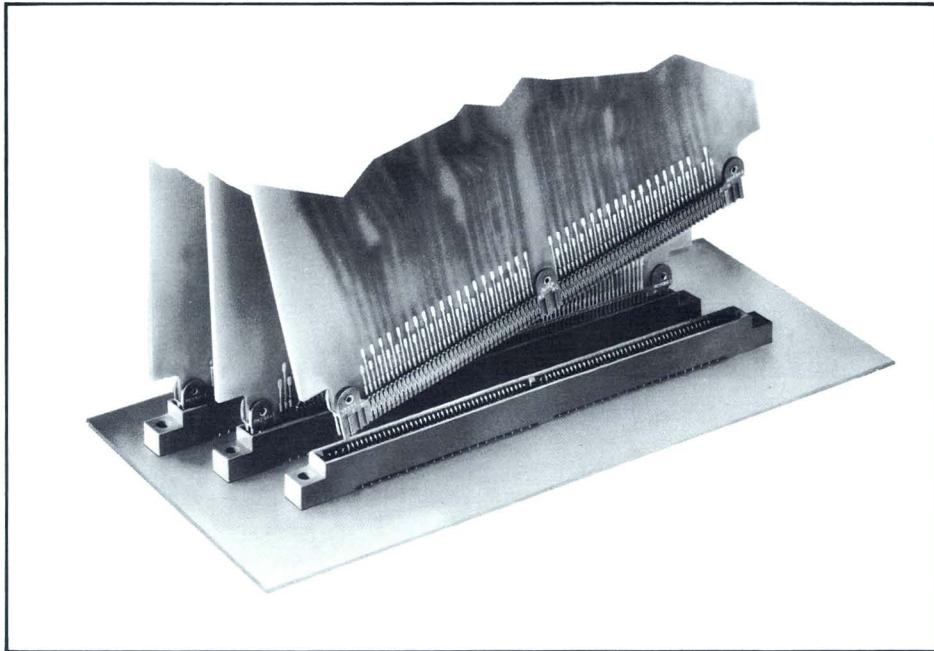

The AMP-MECA Sub-Miniature Connector with 160 contacts for board-to-board or wire-to-board connections, is used in high density applications. Both the specially designed rib-type contacts enclosed in the receptacle half and the cantilever beam contacts in the plug half achieve miniaturization with .050" center-to-center spacing.

Plug contacts are dual cantilever beam design to provide the desired redundancy in one-half the space normally required with standard .050" grid systems. The cantilever beam that makes possible such extreme density also provides low insertion forces of approximately one to two ounces per contact.

For maximum rigidity, the plug half mounts to the module card by three special mounting ears. The seven keying positions at each end of the connector, and the four in the center, provide numerous indexing combina-

tions. Keying pins are made of stainless steel.

In the board-to-board application, the receptacle is mounted to the mother board by mating holes or threaded inserts. Contact tines protrude through the mother board and are either soldered or welded to the circuit pads. The wire-to-board receptacle mounts to a rack or chassis in the same manner, but the contact tines are provided with a hole to allow attachment of up to 3 #26 AWG wires.

In addition to the 160 position connector, 152 and 76 contact versions are available. A split receptacle enables connection of module board to different mother boards.

The connector meets or exceeds MIL-C-21097B with respect to shock, vibration, insulation resistance, temperature cycling and moisture resistance.

AMP-MECA Subminiature Connector

Features

- Standard AMP gold over nickel plating on a beryllium copper base material*.
- .050" center-to-center spacing
- Precision molded diallyl phthalate housings
- Cantilever beam contacts in plug half
- Low insertion forces
- Wiping action between contacts remove atmospheric contaminants
- Multiple keying positions with stainless steel pins
- Dust covers included

* Except as noted on page 13-33.

HOUSING MATERIAL: Diallyl Phthalate — Blue

CONTACT MATERIAL: Gold Plated Beryllium Copper

160 Position

PERFORMANCE SPECIFICATIONS

Vibration	Per. AMP Spec. 108-9021-Para 4.9: 5-2000 ~ @ 50 G Peak
Shock	MIL-STD-202C, Method 202 (60G)
Test Voltage Potential	500 Volts AC RMS for 1 min. (at sea level)
Operating Temperature	-55°C to +125°C
Current Rating and Voltage Drop	2 Amps, 40 milli-volts (max.) per contact
Durability	500 Cycles (engage-withdraw)
Moisture Resistance	MIL-STD-202B, Method 106A
Insulation Resistance	Greater than 5000 Megohms between contacts

PLUG ASSEMBLY No. 86544-1

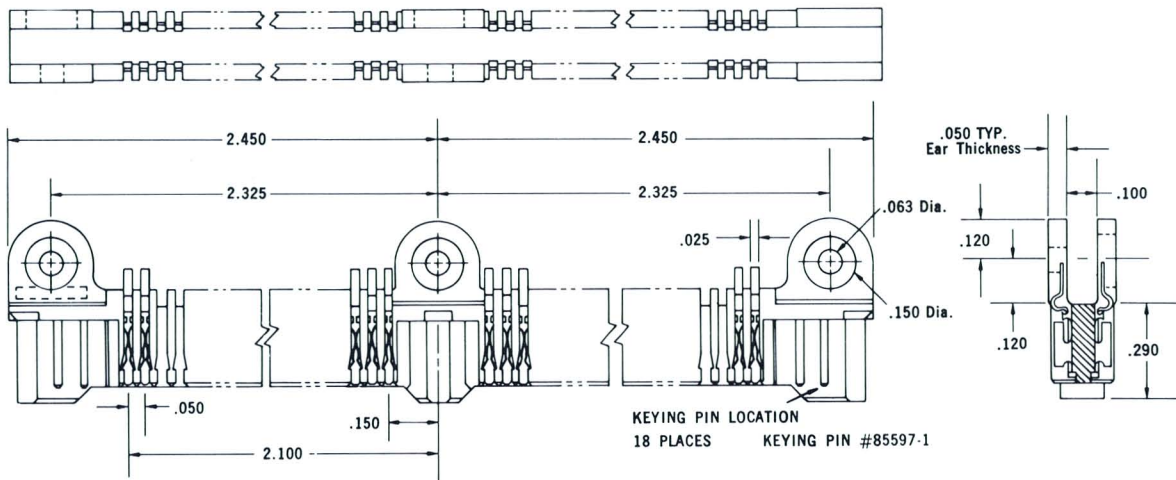

RECEPTACLE ASSEMBLY No. 86548-1

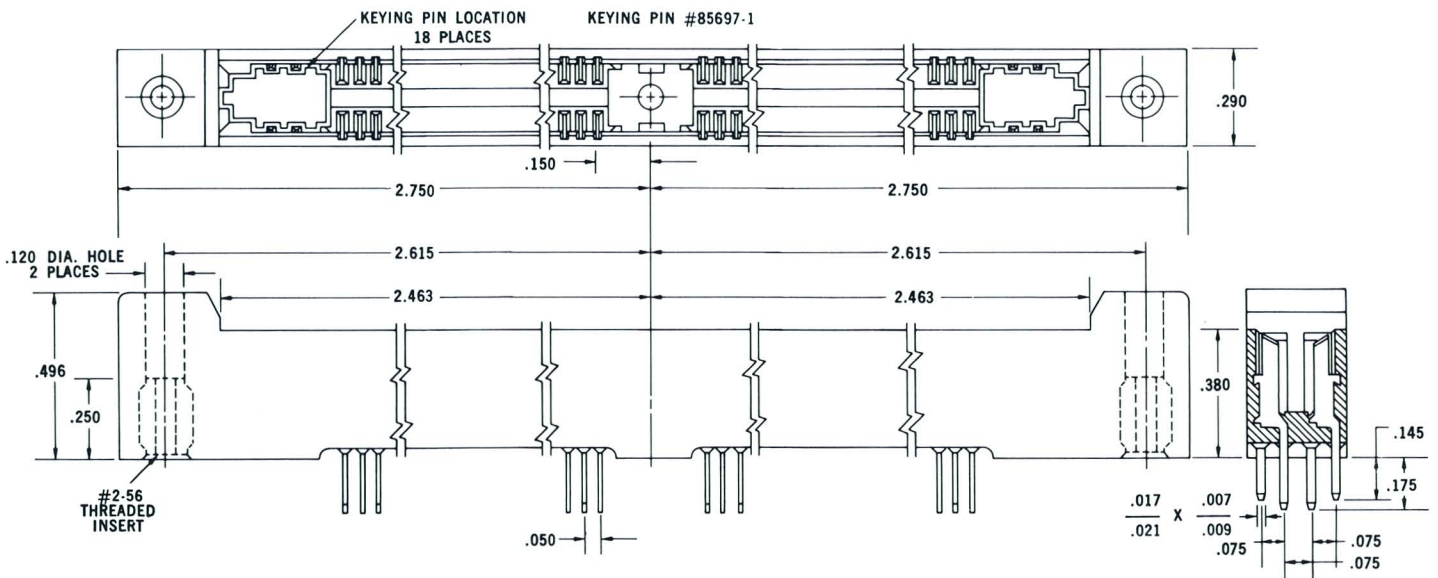

160 Position (Continued)

RECEPTACLE ASSEMBLY No. 86550-1

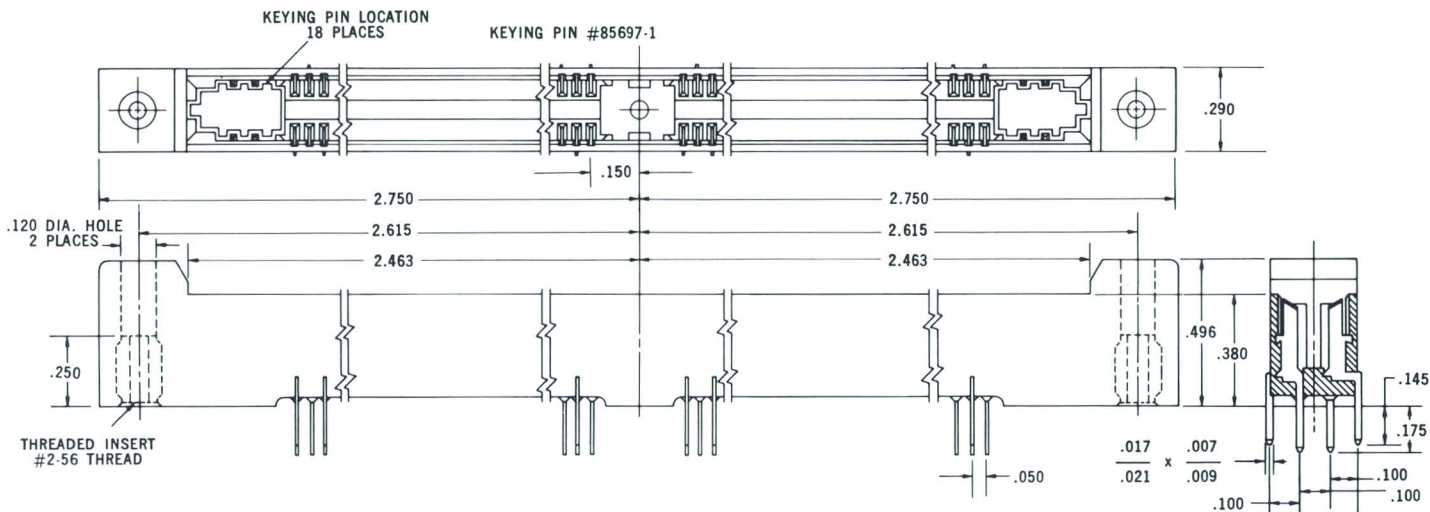

RECEPTACLE ASSEMBLY No. 86546-1

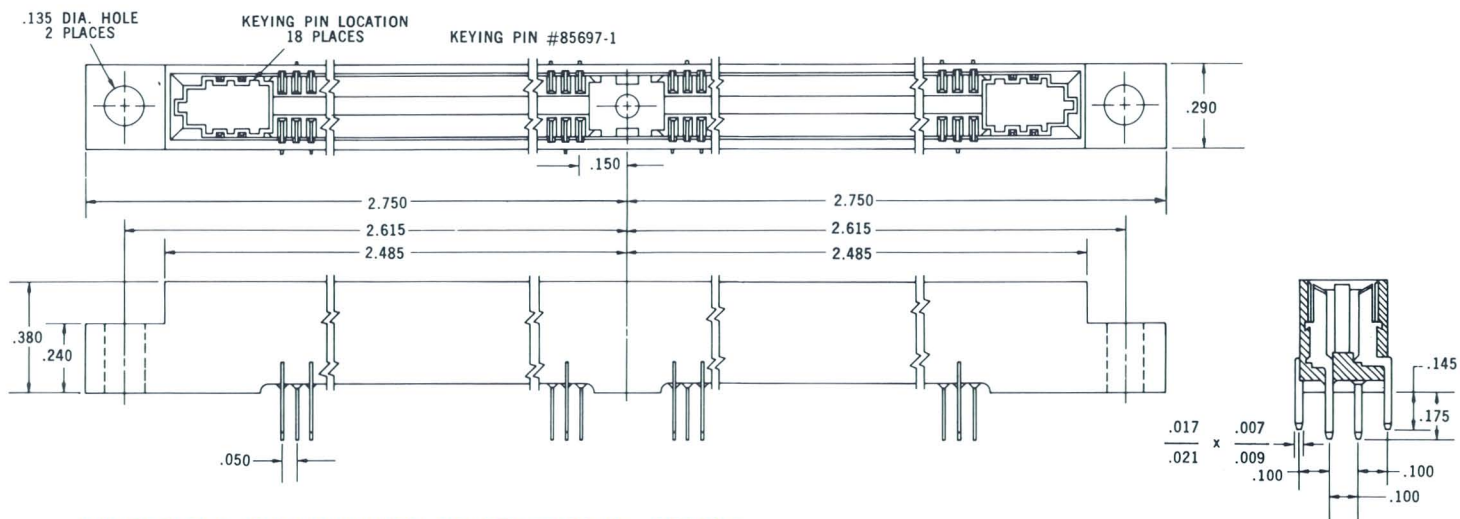

RECEPTACLE ASSEMBLY WITH SOLDER TABS No. 85870-2

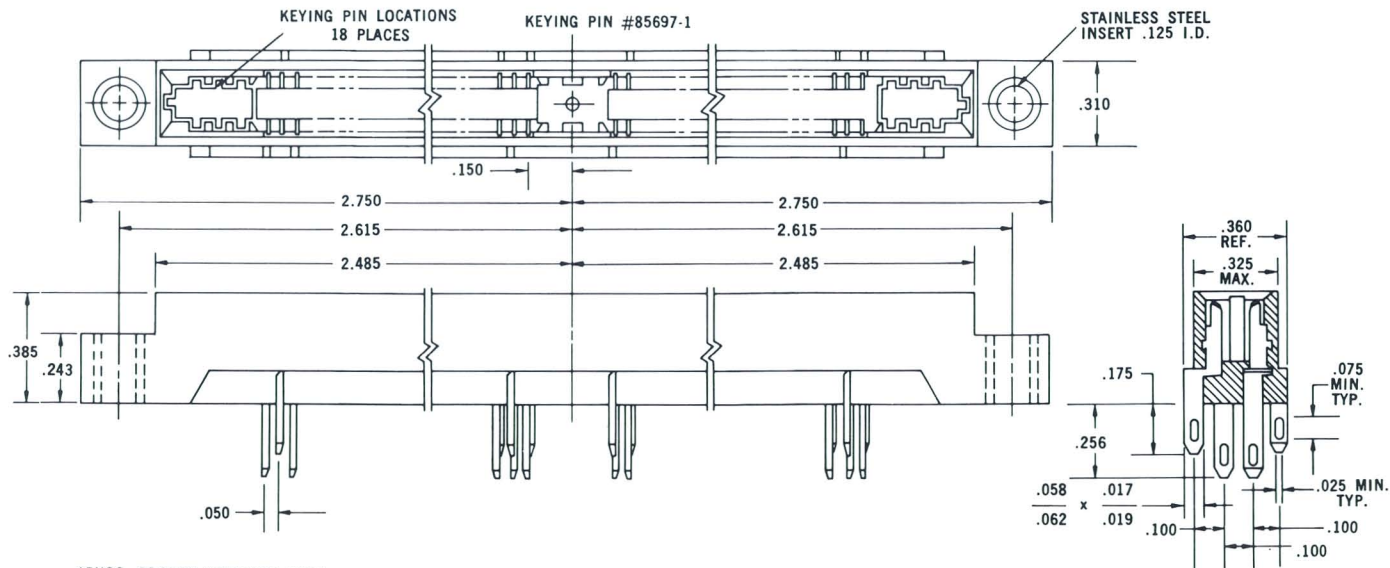

*PHOS. BRONZE CONTACTS ONLY

HOUSING MATERIAL: Diallyl Phthalate — Blue
CONTACT MATERIAL: Gold Plated Beryllium Copper

152 Position PLUG ASSEMBLY No. 86544-2

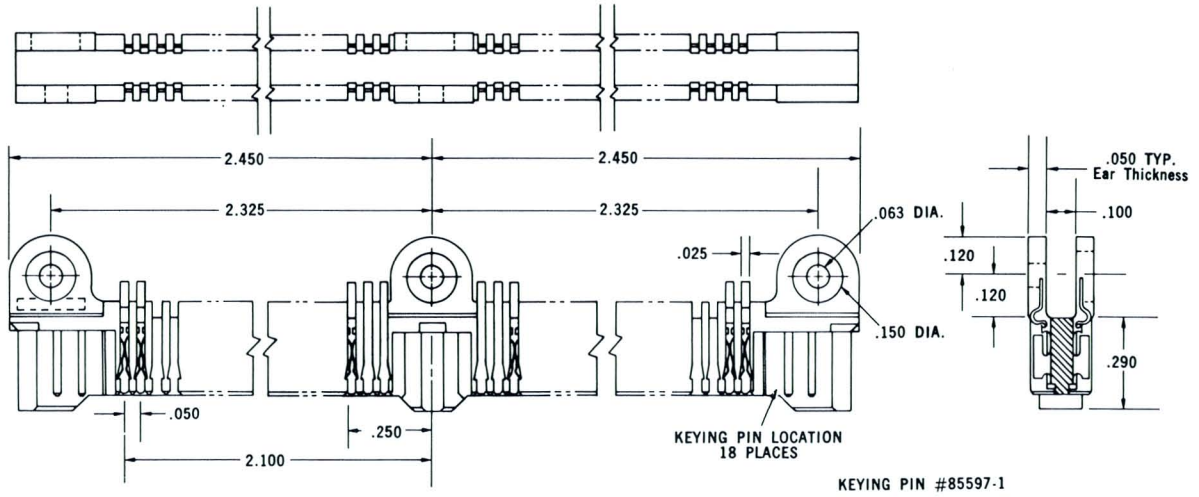

RECEPTACLE ASSEMBLY No. 86552-1 (Two Required)

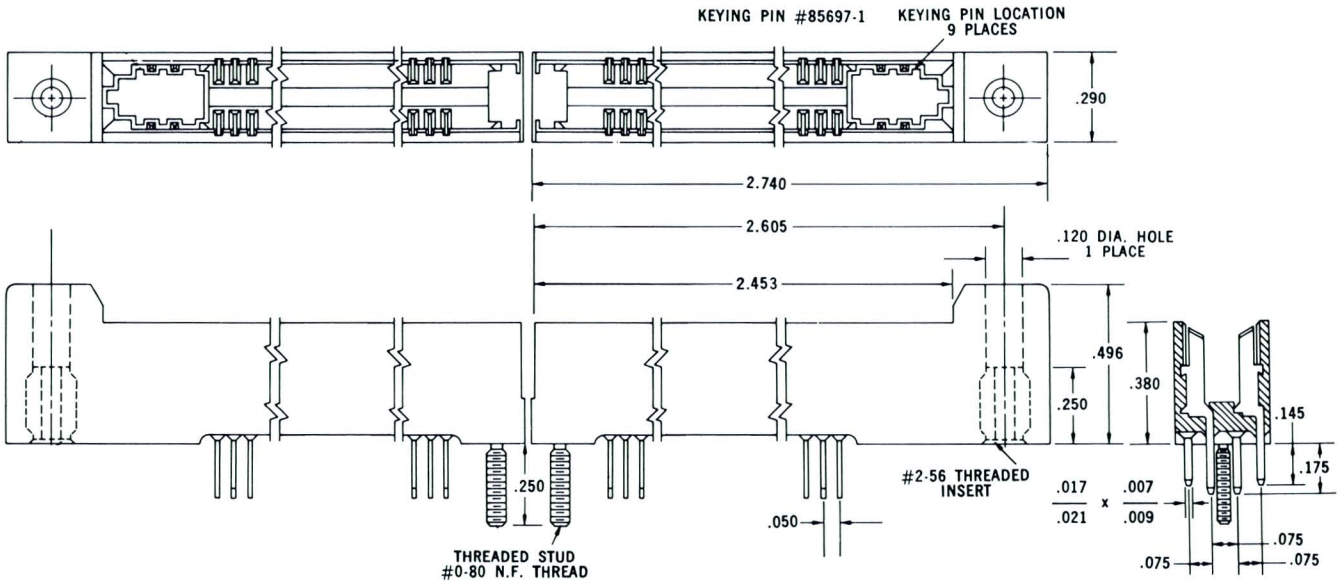

TYPICAL MOUNTING DIMENSIONS (152 and 160 Positions)

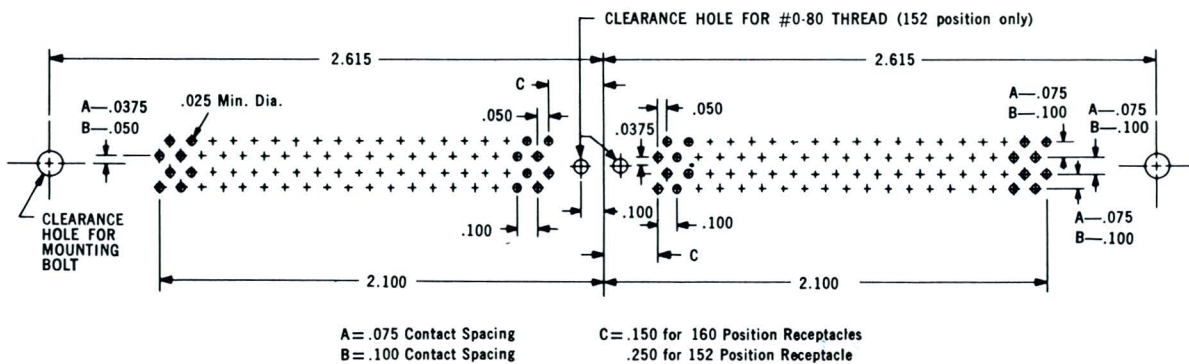

76 Position

HOUSING MATERIAL: Diallyl Phthalate — Blue
 CONTACT MATERIAL: Gold Plated Beryllium Copper

PLUG ASSEMBLY No. 86553-1

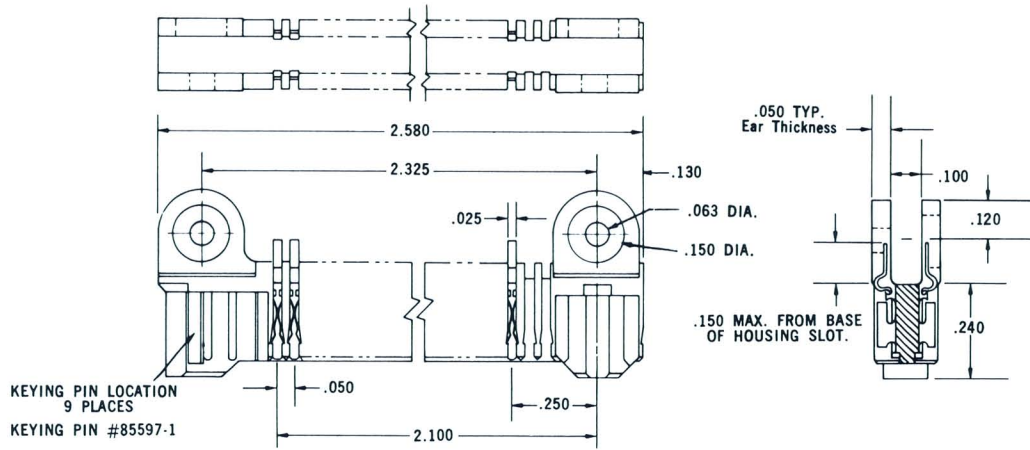

RECEPTACLE ASSEMBLY No. 86554-1

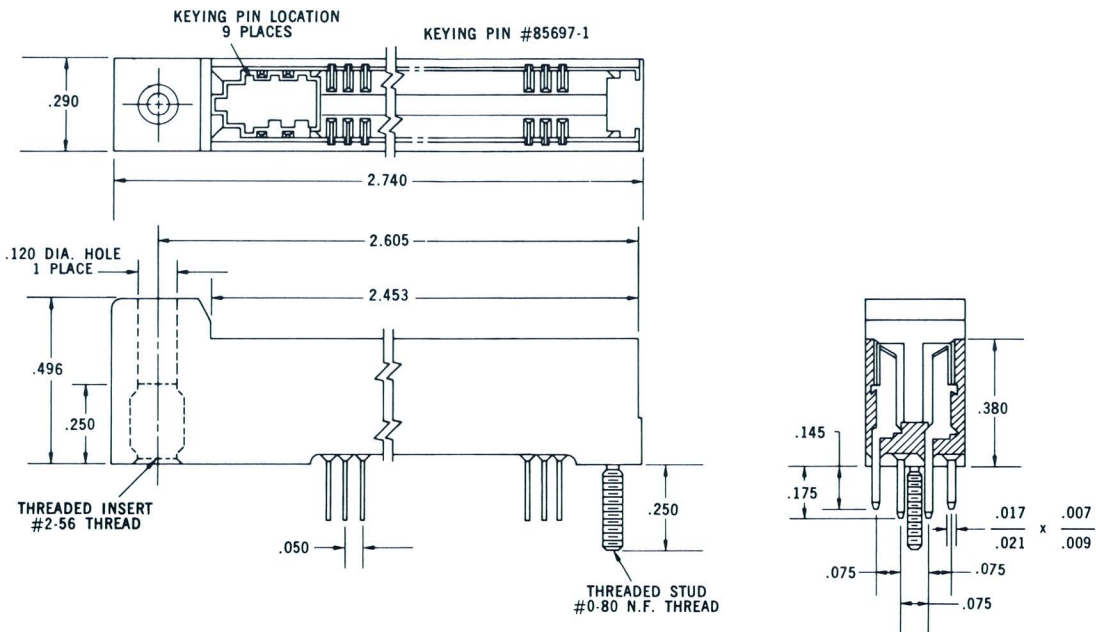

MOUNTING DIMENSIONS

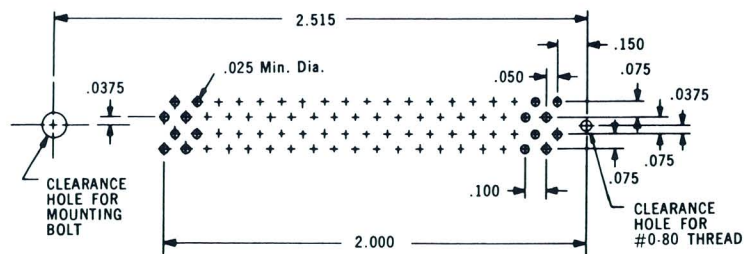

13 AMP

Printed Circuit Connectors

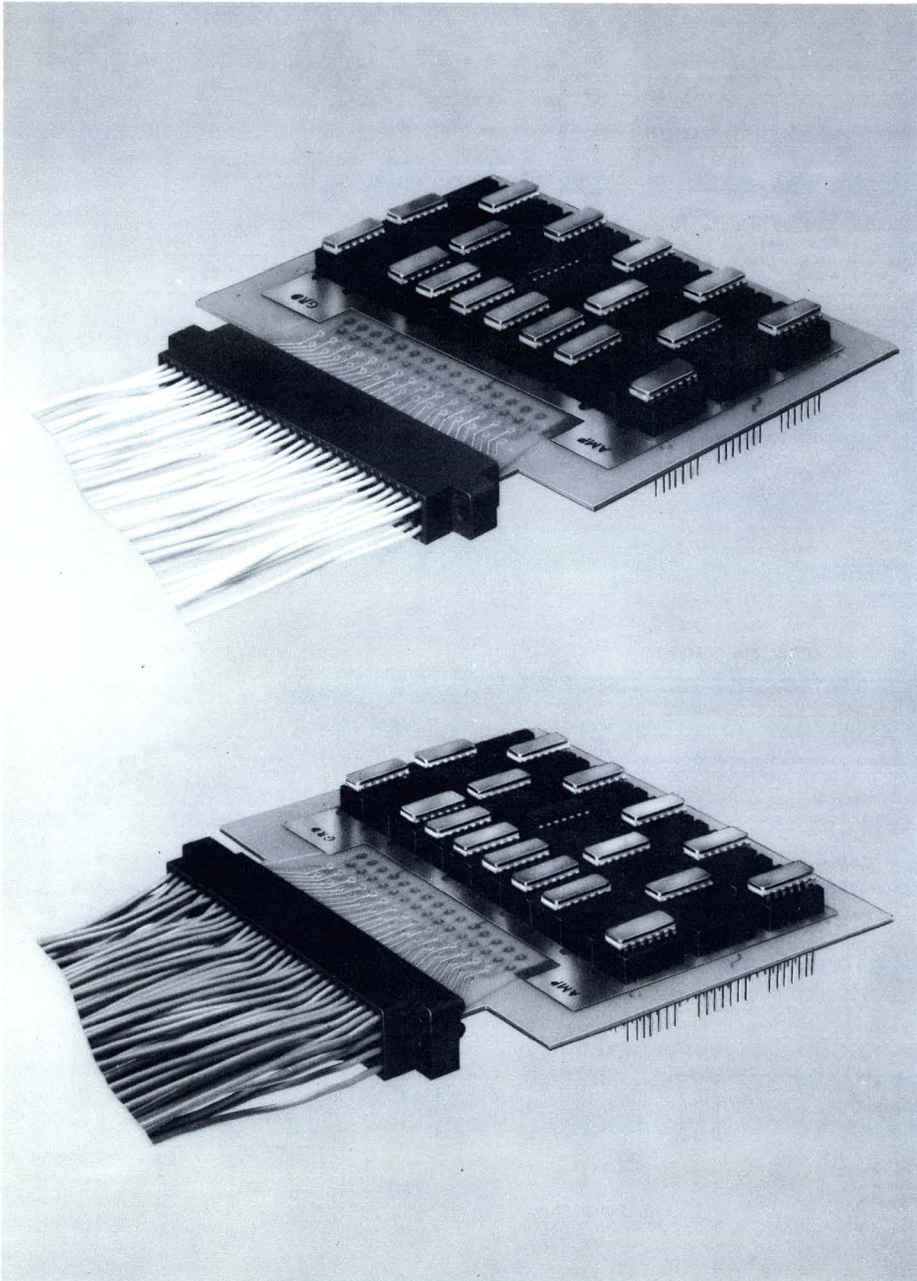

AMP-TAB
Dual & Quad Position
Printed Circuit
Edge Connectors

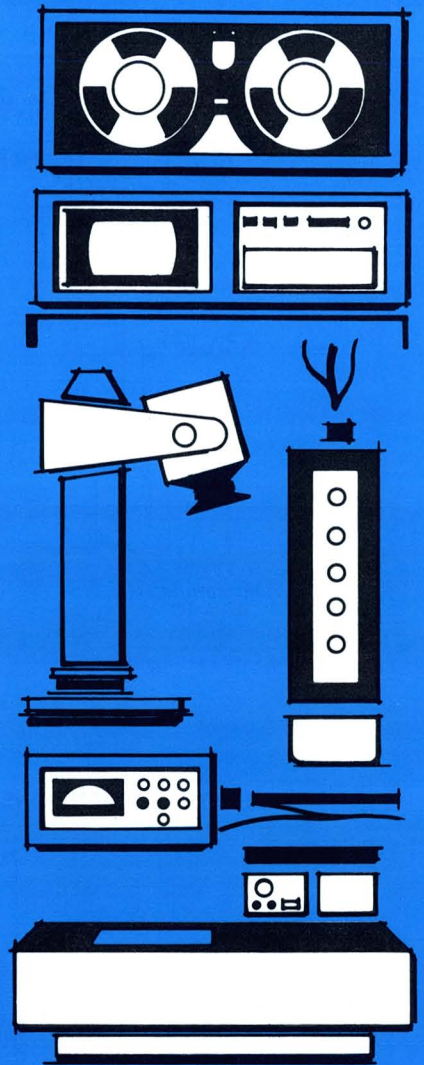

AMP-TAB Contact



Coaxial Contact



AMP-TAB Dual & Quad Position Printed Circuit Edge Connectors

FEATURES

- Rear-entry of tab to connector contact.
- Gold over nickel plating on tab terminal and contact member.
- Cavity identification.
- Inter-contact keying plug and/or keying on contact centerline.
- Hand-insertion and simple tool extraction of tab terminals.
- Wire entry side has anti-flashover egg crating design.
- Glass-fiber filled diallyl phthalate or phenolic connector block material.
- Compression crimped tab terminals with A-MP matched tooling — hand tool or automachine.
- Positive mechanical retention of tabs.
- Contact spacing on .100, .125 and .156 inches.
- Tab terminals accommodate wire size ranges — 18 AWG through 26 AWG.*
- Built-in commoning of contact for dual or quad read-out and circuit redundancy.
- Diallyl phthalate connector performance conforms to MIL-C-21097.

*No. 20 wire size is the maximum for .100" connectors.

The AMP-TAB connector is a one-piece, printed circuit board edge connector. It features, among other things, insertion or extraction of terminals from the rear of the connector block while the printed circuit board is inserted in the connector.

The connector block contains pre-inserted contacts which mate in a firm wiping action with the pads of the printed board. The block material is glass-filled diallyl phthalate conforming to all applicable military specifications or is available in general purpose phenolic. A specially designed card slot prevents the block from accepting over-size printed boards thereby preventing overstress of the spring contacts. The spring contact is made of phosphor bronze with gold over nickel plating, and has excellent resistance to corrosion and long life characteristics.

The connector block has the contact positions numbered front and rear in highly legible characters.

The tab terminals are inserted into the rear of the housing by hand—no insertion tooling is required. When inserted, each tab terminal is fully insulated from adjacent terminals within the connector block, eliminating the necessity for insulation sleeving. Tab terminals utilize the standard AMP "F" crimp with wire insulation support; wire size range is 26 through 18 AWG. These contacts are crimped to leads with high speed A-MP* automatic tools for economy and ease of production.

The AMP-TAB connector is primarily for two-sided boards and is available in two versions: the dual type contact; and the quad type contact. The dual commons the two rear wire terminals to **both** sides of the printed circuit board. The quad (with 4 rear-wire terminals) commons two rear wire terminals to the top of the board and two to the bottom; the board in this case is not commoned.

Extreme flexibility is available with center to center contact spacing of .100, .125, and .156, and connector block capacities of 10 to 43 contact positions. Other features of flexibility are intercontact keying plugs and a simple terminal extraction tool.

Block Material

Diallyl phthalate — conforms to MIL-M-14F, Type SDG-F, or general purpose phenolic

Contact Material

.00003" gold over .00003" nickel plated phosphor bronze for diallyl phthalate blocks .000015" and gold over .00003" nickel plated phosphor bronze for phenolic blocks

ALL DIMENSIONS IN INCHES.

Note: Specifications subject to change. Consult AMP Incorporated for latest design specifications.

Housing Specifications (.100 Centers)

CONNECTORS ACCEPT BOARD THICKNESSES OF .055" TO .070"

DUAL (TWO TABS)



Accepts two tab terminals per position. These common top and bottom paths of the printed circuit board.

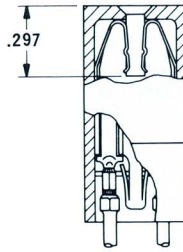
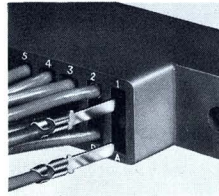

QUAD (FOUR TABS)



Accepts four tab terminals per position. Two common to the top of the printed circuit board, two common to the bottom. Board paths are not commoned.

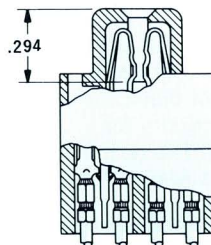
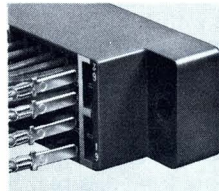

Contact Housing .100 Spacing

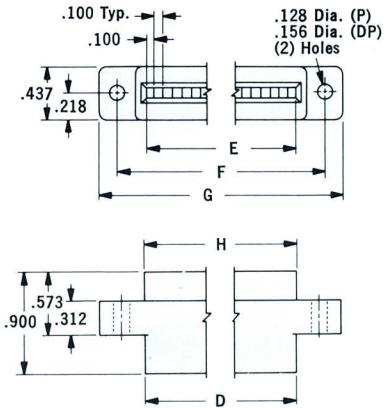

NO. OF POSITIONS	PART NUMBER*	E	F	G	H	D
10	582663-1 (P) 582551-1 (DP)	1.100	1.700	2.100	1.300	1.120
15	582665-1 (P) 582553-1 (DP)	1.600	2.200	2.600	1.800	1.620
18	582667-1 (P) 582555-1 (DP)	1.900	2.500	2.900	2.100	1.920
22	582669-1 (P) 582557-1 (DP)	2.300	2.900	3.300	2.500	2.320
31	582671-1 (P) 582559-1 (DP)	3.200	3.800	4.200	3.400	3.220
43	582673-1 (P) 582561-1 (DP)	4.400	5.000	5.400	4.600	4.420

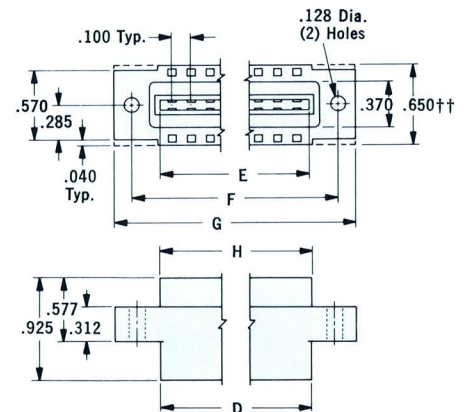

NO. OF POSITIONS	PART NUMBER*	E	F	G	H	D
10	582701-1 (P) 582583-1 (DP)	1.100	1.700	2.100	1.300	1.120
15	582703-1 (P) 582585-1 (DP)	1.600	2.200	2.600	1.800	1.620
18	582705-1 (P) 582587-1 (DP)	1.900	2.500	2.900	2.100	1.920
22	582707-1 (P) 582589-1 (DP)	2.300	2.900	3.300	2.500	2.320
31	582710-1† (P) 582591-1 (DP)	3.200	3.800	4.200	3.400	3.220
43	582712-1 (P) 582593-1 (DP)	4.400	5.000	5.400	4.600	4.420
50	583763-1 (P)	5.100	5.700	6.100	5.300	5.120

* (P) = Phenolic. (DP) = Diallyl Phthalate. † Available with Floating Bushings.

** 31 Position Phenolic — .150 Dia. 2 holes. †† Mounting ear style optional to AMP due to method of manufacture.

*** Except 18 position (Part No. 582732-3) is .150. NOTE: Mounting hole sizes other than those indicated available upon request.

Housing Specifications (Continued)
(.125 and .156 Centers)

CONNECTORS ACCEPT BOARD THICKNESSES OF .055" TO .070"

Contact Housing
.125 Spacing

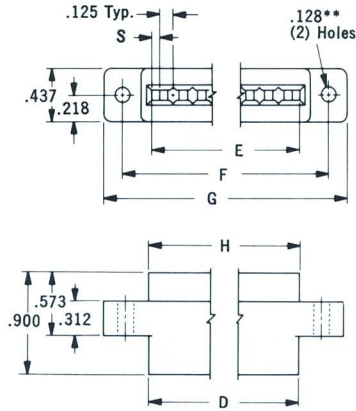

Contact Housing
.156 Spacing

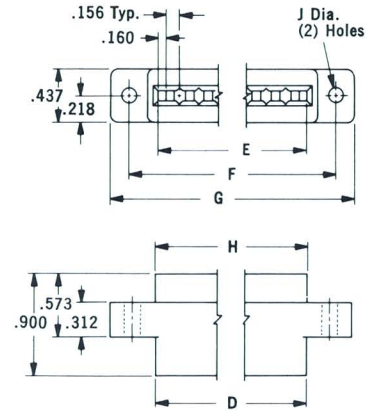

NO. OF POSITIONS	PART NUMBER*	E	F	G	H	D	S
10	582675-1 (P) 582563-1 (DP)	1.325	1.791	2.091	1.491	1.360	.100
15	582677-1 (P) 582565-1 (DP)	1.950	2.416	2.716	2.116	1.985	.100
18	582679-1 (P) 582567-1 (DP)	2.325	2.791	3.091	2.491	2.360	.100
22	582681-1 (P) 582569-1 (DP)	2.825	3.291	3.591	2.991	2.860	.100
31	582683-3 (P) 582509-1 (DP)	3.875	4.250	4.500	4.000	3.962	.062
41	582685-1 (P) 582512-1 (DP)	5.125	5.609	5.906	5.250	5.212	.062
43	582687-1 (P) 582571-1 (DP)	5.450	5.916	6.216	5.616	5.485	.100

NO. OF POSITIONS	PART NUMBER*	E	F	G	H	D	J DIA.
10	582689-1 (P) 582573-1 (DP)	1.724	2.158	2.408	1.888	1.616	.128†
15	582691-1 (P) 582575-1 (DP)	2.504	2.938	3.188	2.668	2.396	.128
18	582693-1 (P) 582577-1 (DP)	2.972	3.406	3.656	3.136	2.864	.128
22	582695-1 (P) 582508-1 (DP)	3.596	4.030	4.280	3.760	3.488	.128
30	582795-1 (P) 582791-1 (DP)	4.844	5.278	5.528	5.008	4.736	.128
31	582697-1 (P) 582579-1 (DP)	5.000	5.434	5.684	5.164	4.892	.128
43	582699-1† (P) 582581-1 (DP)	6.872	7.306	7.556	7.036	6.764	.128

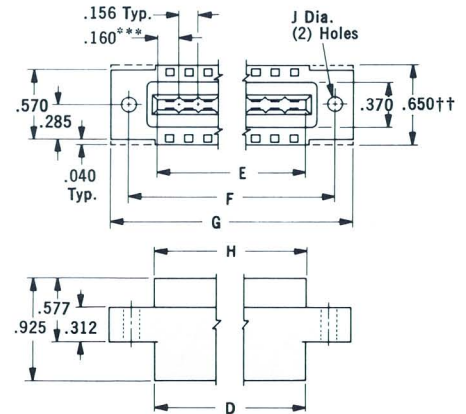
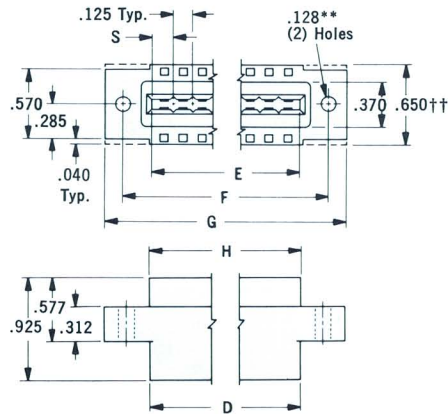

NO. OF POSITIONS	PART NUMBER*	E	F	G	H	D	S
10	582714-1 (P) 582595-1 (DP)	1.325	1.791	2.091	1.491	1.360	.100
15	582716-1 (P) 582597-1 (DP)	1.950	2.416	2.716	2.116	1.985	.100
18	582718-1 (P) 582599-1 (DP)	2.325	2.791	3.091	2.491	2.360	.100
22	582720-1 (P) 582601-1 (DP)	2.825	3.291	3.591	2.991	2.860	.100
31	582722-1 (P) 582603-1 (DP)	3.875	4.250	4.500	4.000	3.962	.062
41	582724-1 (P) 582605-1 (DP)	5.125	5.609	5.906	5.250	5.212	.062
43	582726-1 (P) 582607-1 (DP)	5.450	5.916	6.216	5.616	5.485	.100

NO. OF POSITIONS	PART NUMBER*	E	F	G	H	D	J DIA.
10	582728-1 (P) 582609-1 (DP)	1.724	2.158	2.408	1.888	1.616	.128
15	582730-1 (P) 582611-1 (DP)	2.504	2.938	3.188	2.668	2.396	.128
18	582732-1 (P) 582732-3 (P)	2.972	3.406	3.656	3.136	2.864	.128
18	582732-3 (P) 582613-1 (DP)	2.953	3.406	3.656	3.110	2.864	.130
22	582613-1 (DP) 582734-1 (P)	2.972	3.406	3.656	3.136	2.864	.128
22	582734-1 (P) 582528-1 (DP)	3.596	4.030	4.280	3.760	3.488	.128
30	582797-1 (P) 582793-1 (DP)	4.844	5.278	5.528	5.008	4.736	.128
31	582736-1 (P) 582615-1 (DP)	5.000	5.434	5.684	5.164	4.892	.128
43	582738-1† (P) 582617-1 (DP)	6.872	7.306	7.556	7.036	6.764	.128

*(P) = Phenolic. (DP) = Diallyl Phthalate.
 **31 Position Phenolic — .150 Dia. 2 holes.
 ***Except 18 position (Part No. 582732-3) is .150.

†Available with Floating Bushings.
 ††Mounting ear style optional to AMP due to method of manufacture.
 NOTE: Mounting hole sizes other than those indicated available upon request.

Product Specifications

PRODUCT SPECIFICATIONS

(for diallyl phthalate only)

This data covers the general requirements for multi-contact connector assemblies with special emphasis of conformance to MIL-C-21097B. The following military specifications also apply:

MIL-W-16878D	MIL-STD-275A
MIL-STD-202C	QQ-N-290
MIL-G-45204	QQ-B-750
MIL-M-14F	

See AMP Product Specification 108-9005 & 108-9208.

Electrical Characteristics

- Contact Rating: The maximum current rating for these contacts is 5 amperes.
- Operating Temperature: Connectors have a maximum operating temperature of +125°C and a minimum temperature of -65°C.

Construction

- Contact Material: Conforms to QQ-B-750, Phosphor Bronze.
- Contact Plating: Contacts are gold plated .00003 minimum over nickel plating of .00003 minimum. Gold plating conforms to MIL-G-45204 and nickel plate conforms to QQ-N-290.

Connector Housing Cavity

Identification: Alpha numerical coding identifies receptacles on both mating and wire entering surfaces where space permits.

Performance

HIGH POTENTIAL

ALTITUDE	TEST VOLTAGE (AC, RMS)		
	Contact Centerline Spacing		
	.100	.125	.156
Sea Level	650	1,500	1,800
50,000 Feet	275	525	675
70,000 Feet	275	375	450

Individual Contact Engaging and Separating Force: 16 ounces maximum engaging force — 2 ounces minimum separation force.

Keying Plugs



Contact Keying Plug
Part No. 583487-1
(.100, .125 & .156 Centers)

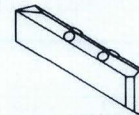

Inter Contact Keying Plug
Part No. 582501-1
(.125 & .156 Centers)

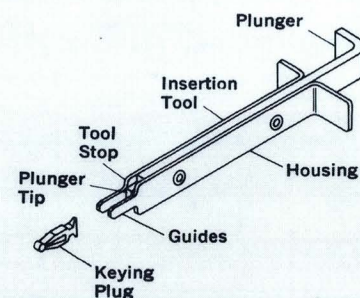
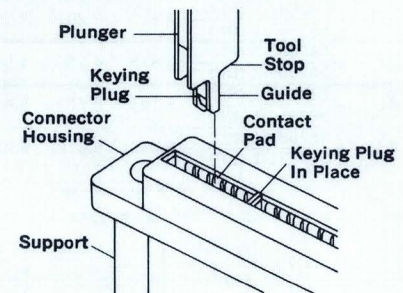

Keying Plug Insertion Tool
Part No. 91056-1

This tool consists of a Plunger and Plunger Housing. The Plunger Tip is designed to distribute the full insertion force on the Keying Plug. This ensures proper seating of the Keying Plug without any possible damage to the Connector. Keying Plug Guides have been designed on the Plunger Housing to facilitate centering of the Keying Plugs on the Contact Pads.

Contacts and Tooling

Crimp Type Contacts

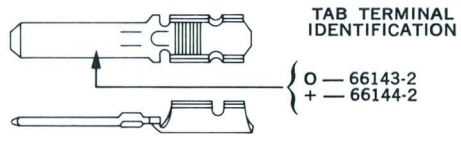

WIRE RANGE	INSULATION RANGE	FINISH	PART NO.		
			LOOSE PIECE	STRIP FORM (For Standard Applicator)	STRIP FORM (For Miniature Applicator)
26-22	.035-.054	.000030 Gold over	66168-2	66143-2	66355-2
22-18	.054-.074	.000030 Nickel	66169-2	66144-2	583278-2
26-22	.035-.054	.000015 Gold over	66168-3	66143-3	66355-3
22-18	.054-.074	.000030 Nickel	66169-3	66144-3	583278-3
26-22	.035-.054	.000050 Gold over	66168-6	66143-6	66355-6
22-18	.054-.074	.000030 Nickel	66169-6	66144-6	583278-6

Eyelet Type Contact

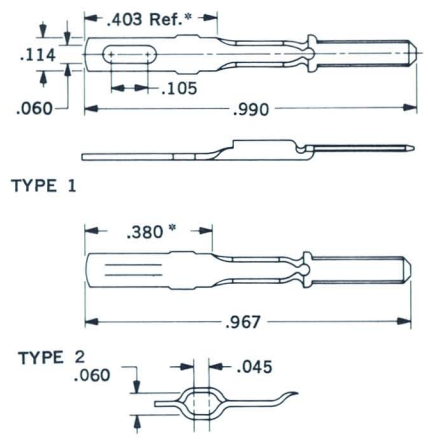

*Extension from rear of block

PART No.	TYPE	PLATING	MATERIAL
582660-1	1	.000030 Gold over	Phosphor Bronze
582660-2	2	.000030 Nickel	
582660-3	1	.000015 Gold over	
582660-4	2	.000030 Nickel	



EXTRACTION TOOL
DUAL #91011-1 — QUAD #91017-3

Coaxial Crimp Type Contacts

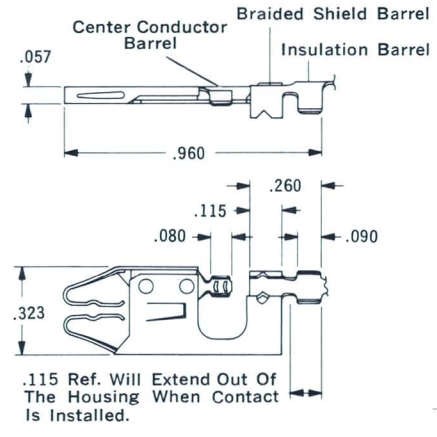

Coaxial Contacts for .100, .125 & .156 Dual Housings

RG/U CABLE NO.	PART NO. (STRIP FORM*)	FINISH
RG196A or Equivalent	583392-3	Gold over Nickel with Selective Gold on Contact Spring Area
	583392-2	Gold over Nickel
	583392-1	Tin Plated

Center Conductor Barrel Range—#26-30 AWG.
Braided Shield Barrel Range—.045-.055 Dia.
Insulation Barrel Range—.075-.085 Dia.

Note: Hand Crimping Tool—Part No. 90233-1
*For loose piece specify "LP" after Part No.

Coaxial Contacts for .125 & .156 Dual Housings

RG/U CABLE NO.	PART NO. (STRIP FORM*)	FINISH
RG174 or Equivalent	583394-3	Gold over Nickel with Selective Gold on Contact Spring Area
	583394-2	Gold over Nickel
	583394-1	Tin Plated

Center Conductor Barrel Range—#26-30 AWG.
Braided Shield Barrel Range—.070-.080 Dia.
Insulation Barrel Range—.095-.105 Dia.
Note: Hand Crimping Tool—Part No. 90255-1.
*For loose piece specify "LP" after Part No.

Tooling

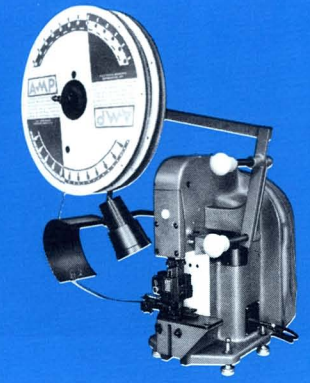

AMP-O-ELECTRIC* Machine

A-MP Automachines are available for automatic crimping of the tab terminals in strip form. These machines exercise the same high degree of control in the compression crimping process while achieving high-speed production rates of up to 3,000 perfectly identical terminations per hour.

The use of the CERTI-CRIMP* Tool is recommended for prototype work, replacement and repair.



CERTI-CRIMP Hand Tool

CON-NECTOR SIZE	WIRE SIZE	INSUL. DIA.	TERMINAL NO.	TOOL NO.
.100, .125 & .156	26-22	.035-.054	66143LP	90090-2
.100, .125 & .156	26-22	.035-.054	66143LP	90174-1
.100, .125 & .156	22-20	.046-.062	66144LP	90174-1
.125 & .156	20-18	.054-.074	66144LP	90090-2

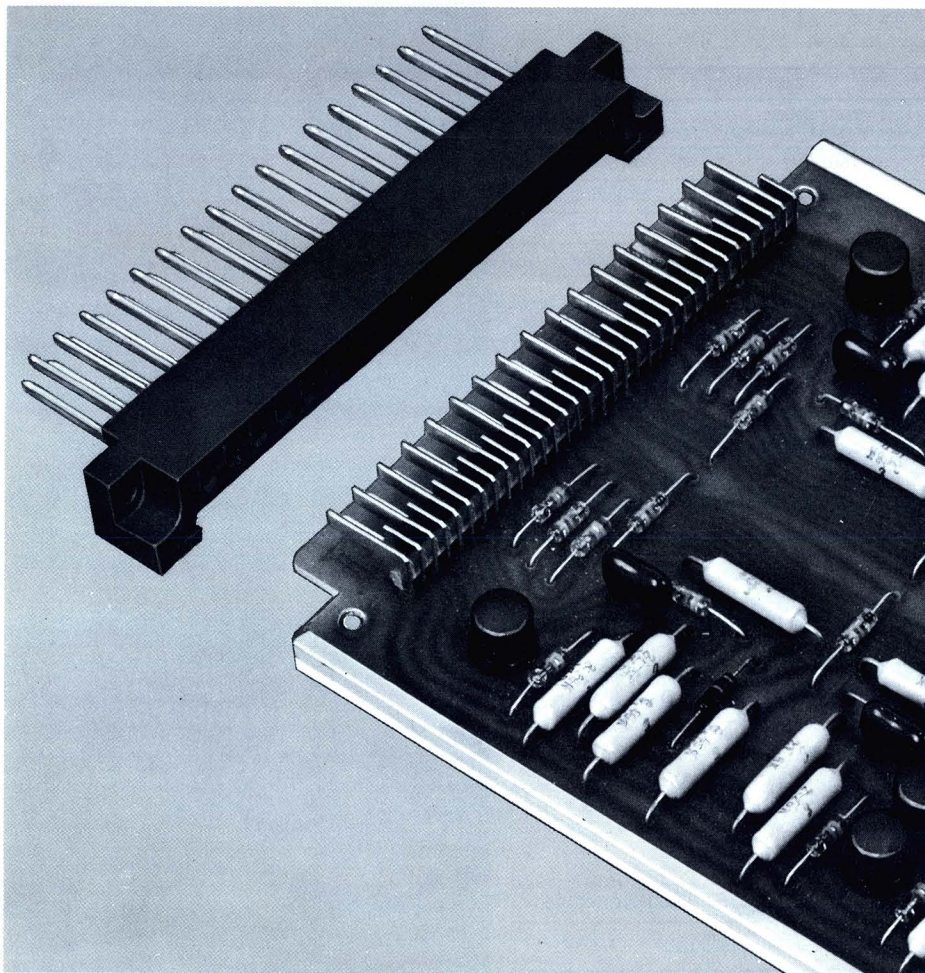

TERMI-GRID Interconnection System

Features

- Receptacle housings — choice of diallyl phthalate or phenolic.
- Housings available in 17, 29, 35, 41, 47 and 53 positions.
- Receptacles available to mate with other blade-type headers.
- Connectors available with single or dual row contacts.
- Contacts on .100" centers-staggered.
- Contacts available with .031" x .062" or .022" x .036" post.
- Contacts gold flash over nickel plating — heavier gold on contact area.
- Contact redundancy for positive electrical continuity.
- Compatible with TERMI-POINT Clip, solder, weld or wrap-type wiring.
- Posts accept up to three TERMI-POINT Clips.
- Male contacts furnished on TEFLON plastic strips for easy staking to the board.
- Polarizing key available.
- Low per line cost.

The TERMI-GRID Interconnection System is a two-piece connector assembly using the fork/bayonet contact approach and is specifically designed to be compatible with A-MP* TERMI-POINT* Clips and Tools.

The receptacle half of this system is pre-loaded with contacts and is available in either diallyl phthalate or phenolic. Contacts are made of phosphor bronze and gold flash over nickel plating (heavier gold plating on the contact area for long life). Individual contacts can be easily extracted with a simple tool for service or repair.

The unique floating design of the TERMI-GRID contact provides a misalignment tolerance of .020" in any direction. This special patented design of the TERMI-GRID contact has a built-in compensation feature

which allows for misalignment during engagement of the blade half, preventing deformation of the receptacle's fork contacts and at the same time maintaining necessary post rigidity for automatic wiring requirements.

The .031" x .062" or .022" x .036" post is designed to be terminated by either the TERMI-POINT Automatic Wiring Machine, pneumatic or manual hand tool.

The male TERMI-POINT Contacts are pre-spaced to mate with the receptacles and are available on TEFLON† plastic strips. These strips facilitate assembling the male header to the board and do not need to be removed after the contacts are staked. Male contacts are brass with gold flash over nickel (heavier gold plating on the contact area).

Type I

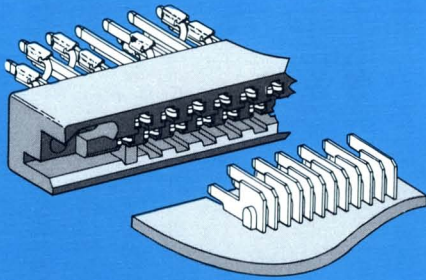

UNLIMITED CARD SLOT WIDTH

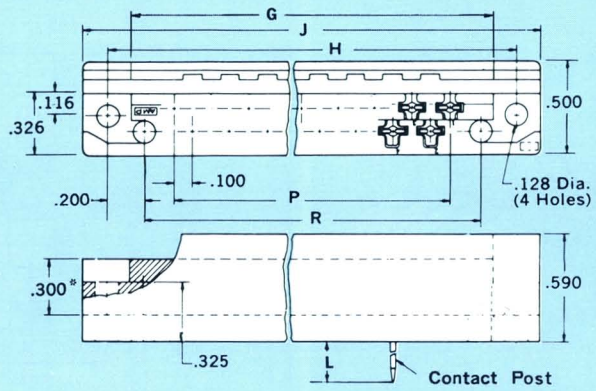

Type II

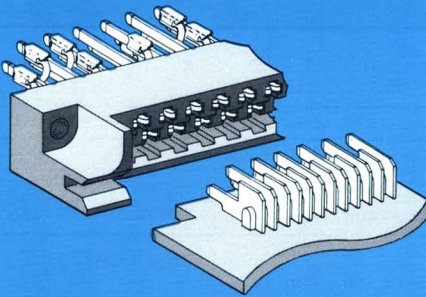

BUILT-IN CARD GUIDE

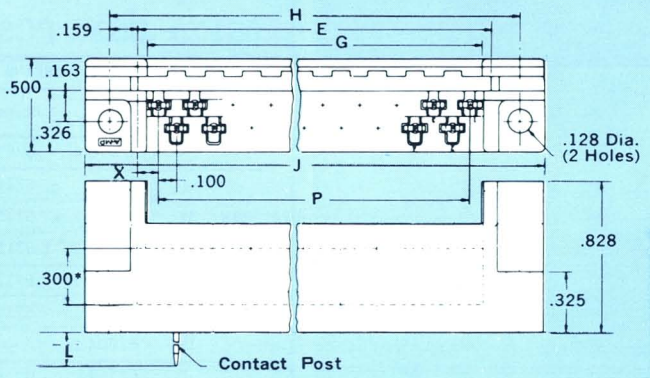

Type III

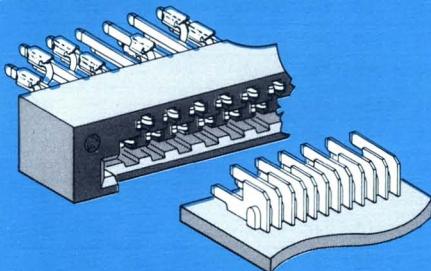

CONVENTIONAL CARD SLOT

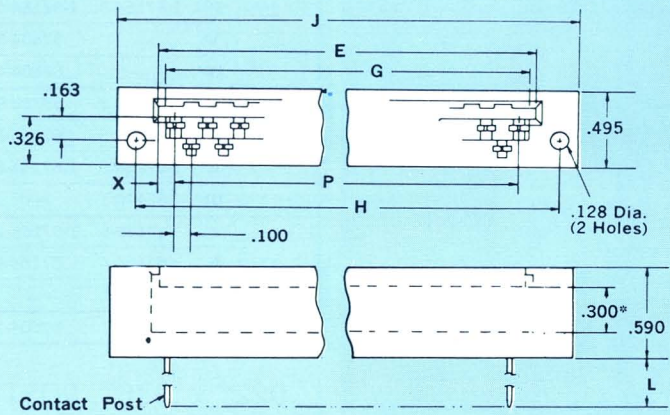

Type IV
(Type III modified)

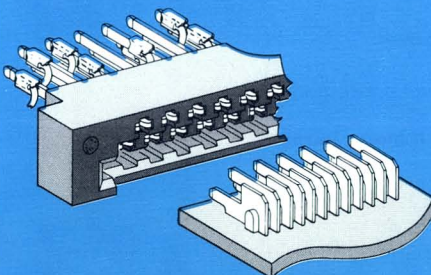

HOUSING MODIFIED FOR FLUSH
PANEL MOUNTING

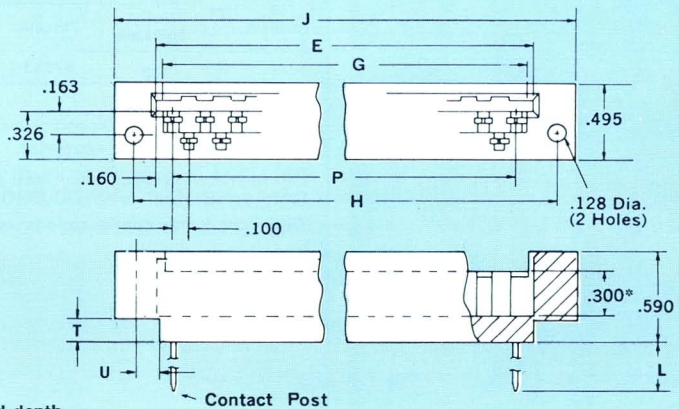

*Module card depth

Type V
(Type II modified)

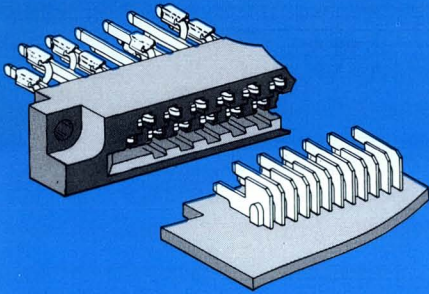

HOUSING MODIFIED FOR FLUSH
PANEL MOUNTING

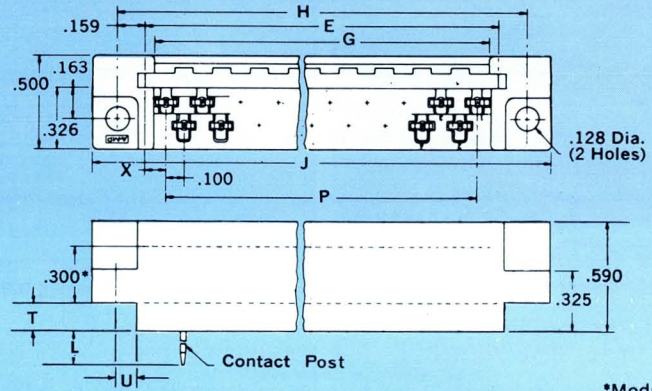

*Module card depth

.031" x .062" POSTS

Number of Positions	Type	PART NUMBERS		E	G	H	J	L	P	R	T	U	X
		Diallyl Phthalate	Phenolic										
17	III	67476-4	67476-8	1.920	1.795	2.134	2.396	.740	1.600	—	—	—	.160
	I	67168	67168-6	—	2.960	3.500	3.760	.740	2.800	3.100	—	—	—
29	II	67154-2	67154-7	3.015	2.926	3.334	3.596	.740	2.800	—	—	—	.108
	II	1-67154-2	1-67154-4	3.120	2.926	3.334	3.596	.740	2.800	—	—	—	.160
34**	I	67168-1	67168-7	—	3.560	4.100	4.360	.740	3.400	3.700	—	—	—
	II	67154-1	67154-6	3.615	3.525	3.934	4.196	.740	3.400	—	—	—	.108
35	IV	67604-5	—	3.720	3.525	3.934	4.196	.740	3.400	—	.140	.159	.160
	I	67168-2	67168-8	—	3.560	4.100	4.360	.740	3.400	3.700	—	—	—
35	II	67154	67154-5	3.615	3.525	3.934	4.196	.740	3.400	—	—	—	.108
	II	1-67154-3	1-67154-5	3.720	3.525	3.934	4.196	.740	3.400	—	—	—	.160
35	V	—	67604-3	3.720	3.525	3.934	4.196	.740	3.400	—	.140	.159	.160
	IV	—	67604-4	3.720	3.525	3.934	4.196	.740	3.400	—	.140	.159	.160
41	I	67168-3	67168-9	—	4.160	4.700	4.960	.740	4.000	4.300	—	—	—
	II	67154-3	67154-8	4.215	4.125	4.534	4.796	.740	4.000	—	—	—	.108
41	II	1-67154-0	1-67154-6	4.320	4.125	4.534	4.796	.740	4.000	—	—	—	.160
	III	67476-1	—	4.320	4.125	4.534	4.796	.740	4.000	—	—	—	.160
47	I	67168-5	1-67168-1	—	4.260	5.300	5.560	.740	4.600	4.900	—	—	—
	II	67154-4	67154-9	5.030	4.940	5.352	5.610	.740	4.600	—	—	—	.215
47	III	67476-5	—	5.030	4.940	5.352	5.610	.740	4.600	—	—	—	.215
	IV	—	67604-1	5.520	5.325	5.734	5.996	.740	5.200	—	.120	.180	—

.022" x .036" POSTS

Number of Positions	Type	PART NUMBERS		E	G	H	J	L	P	R	T	U	X
		Diallyl Phthalate	Phenolic										
35	III	—	67813-1	3.720	3.525	3.934	4.196	.594	3.400	—	—	—	.160

**Same housing as 35 position with No. 1 contact removed.

Receptacle Contact Material:

Phosphor Bronze, Gold Flash over .000100 Nickel entire part,

Gold on contact area .000030

Other connector configurations available, contact AMP Incorporated.

Male Contact Strips

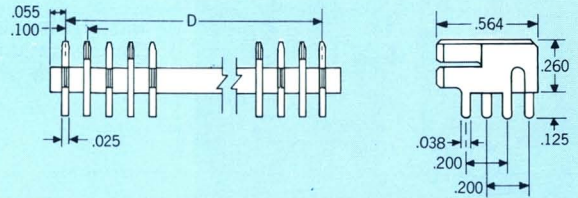

Contact Material and Finish:
 Brass, Gold Flash over .000050 Nickel entire part, .000030 Gold on contact area.

Number of Positions	Part Number	D
17	67246-6	1.600
29	67246	2.800
34	67246-1	3.300
35	67246-2	3.400
41	67246-3	4.000
47	67246-4	4.600
53	67246-7	5.200

Clinching Die Set No. 265190-1.

Mounting Dimensions

.052 ± .000
 .004 Dia. Holes
 Center of Holes
 to be Within
 .003 of True Position
 Notches not required
 For Type I Connector
 Maximum Board
 Thickness .062"

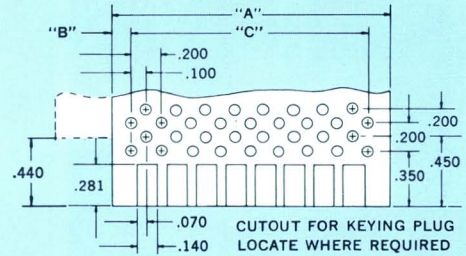

Number of Positions	Part Number	Type II, III, IV & V Only			All Types
		A	B	C	
17	67476-4, 67476-8	1.905	.152	1.600	
29	67168, 67168-6, 67154-2, 67154-7	3.000	.100	2.800	
	1-67154-2, 1-67154-4	1.105	.152	2.800	
34	67168-1, 67168-7, 67154-1, 67154-6, 67604-5	3.600	.100	3.300	
35	67168-2, 67168-8, 67154, 67154-5, 67813-1	3.600	.100	3.400	
	1-67154-3, 1-67154-5, 67604-3, 67604-4	3.705	.152	3.400	
41	67168-3, 67168-9, 67154-3, 67154-8	4.200	.100	4.000	
	1-67154-0, 1-67154-6, 67476-1	4.305	.152	4.000	
47	67168-5, 1-67168-1, 67154-4, 67154-9, 67476-5	5.015	.207	4.600	
53	67604-1	5.505	.152	5.200	

Keying Plugs

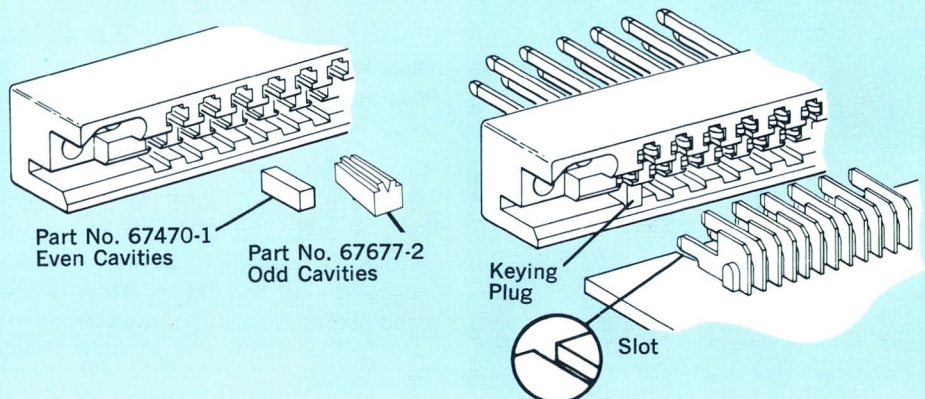

Cross Sectional View of Connector (Typical)

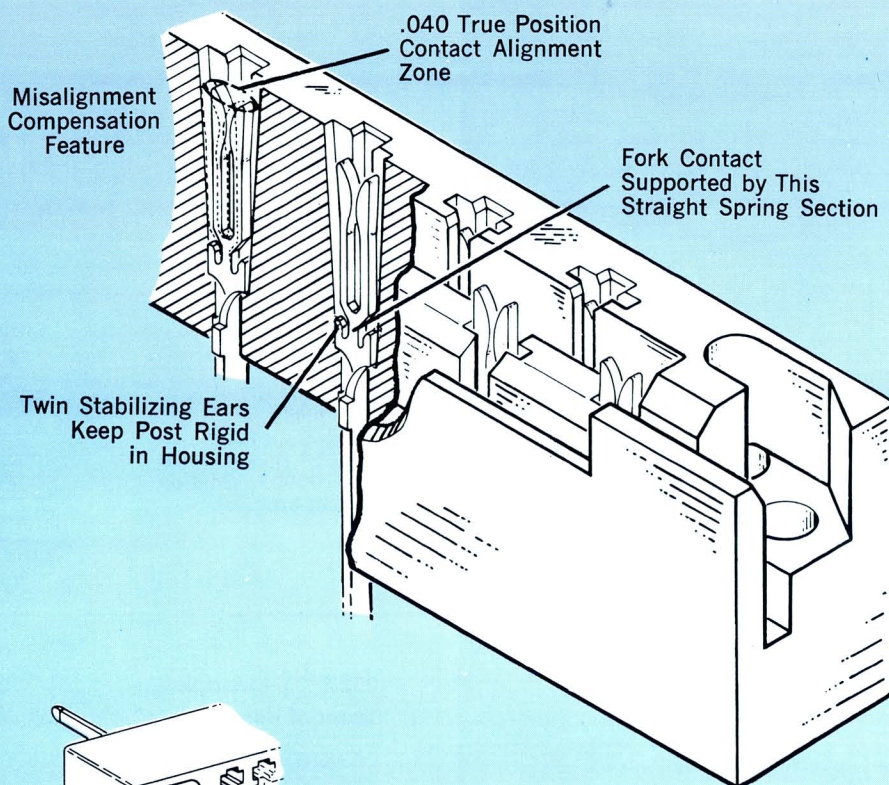

Replacement Contact

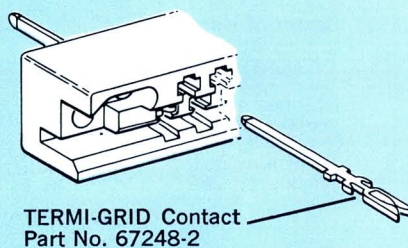

Extraction/Insertion Tool

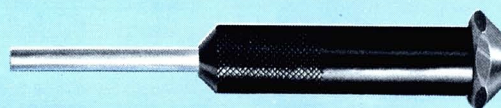
Contact Extraction
Insertion Tool
Part No. 69514-1

Operating Parameters

All A-MP TERMI-GRID connectors are designed to meet the requirements of AMP Product Specification GPS 505-4. The operating parameters of these connectors include:

Operating Temperature — -65°C to $+125^{\circ}\text{C}$ (continuous)

Contact Engaging and Separation Force — 2 oz. (min.) to 16 oz. (max.)

Contact Rating — 5 amps

Test results for the TERMI-GRID connectors are outlined in AMP Test Reports GPR 575-20 and GPR 575-58. Testing categories included in this report are: insulation resistance, dielectric withstanding voltage, contact resistance, contact engaging and separation force, temperature cycling, vibration, shock, durability conditioning, and salt spray-corrosion. Copies of these Test Reports (GPR 575-20 and GPR 575-58) and of AMP Product Specification GPS 505-4 are available upon request.

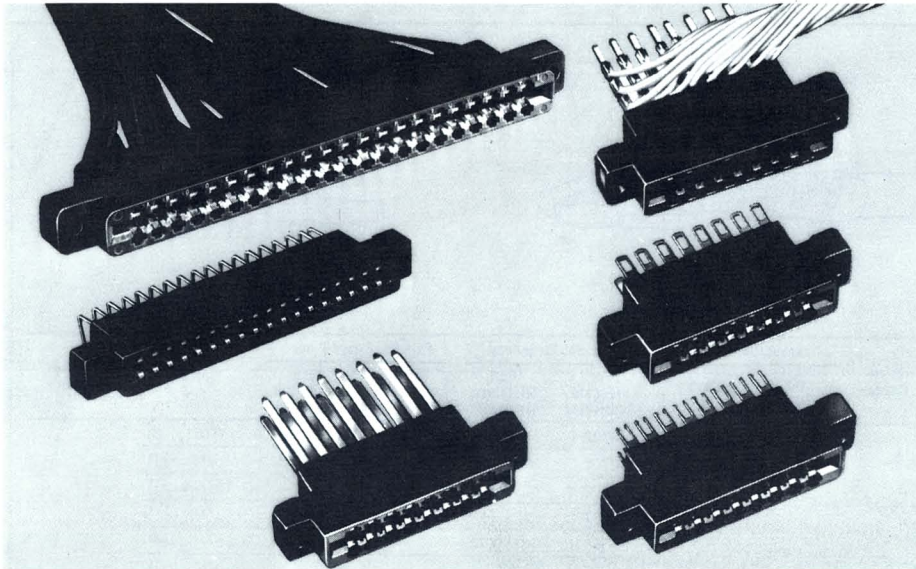

AMP-LEAF One-Piece Printed Circuit Edge Connectors

AMP-LEAF Connectors are available with a choice of six types of contacts: Crimp Type, Post Type, Split Eyelet Type, Standard Eyelet Type and Solder Dip Type, also Right Angle Type.

Product Specifications

ELECTRICAL CHARACTERISTICS

Contact Rating — Maximum current rating for these contacts is 5.0 amperes.

PERFORMANCE

1. Contact Engaging and Separating Force — Maximum engaging force, 16 oz. [4.4 N]; minimum separation force, 2 oz. [0.6 N].
2. Vibration — A completely mated connector assembly, receptacle and printed wiring test board are vibrated in accordance with MIL-STD-202, Method 201.

CONSTRUCTION

1. Housing Materials:
 - a. Diallyl Phthalate per AMP Product Specification 108-9013; Operating Temperature — 65°C to +125°C.
 - b. Phenolic or Thermoplastic per AMP Product Specification 108-9014; Operating Temperature — 55°C to +105°C.
2. Contacts:
 - a. Tin plated per AMP Product Specification 108-9043; Operating Temperature — 40°C to +85°C.
 - b. Terminated per AMP Crimp Specification 114-9003.

The Crimp Type Printed Circuit Connector is supplied with the housing unloaded — the user buys only enough contacts to satisfy circuit requirements. This feature, when coupled with the AMP matched terminal-tooling crimping concept, contributes substantially to lower installed costs.

The Post Type Printed Circuit Connector is specifically designed to be wired with AMP TERMI-POINT clips and tools. The connector and post designs are also adaptable to the wrap-type termination.

The Split Eyelet Type Printed Circuit Connector simplifies solder bus wiring. The end of the contact is notched to permit wire to be easily snapped into place for soldering. Its flanged construction provides maximum tab strength. The tab will accept up to two #18 AWG [0.8-0.9 mm²] stranded wires.

The standard Eyelet Type Printed Circuit Connector is supplied with solder eyelet contacts that incorporate tabs with flanged sides for maximum contact strength. These tabs will also accept up to two #18 AWG [0.8-0.9 mm²] stranded wires.

The Solder Dip Type Printed Circuit Connector for mother-daughter board applications is available with contacts pre-assembled in the

housing, either fully loaded or loaded on one side. The contact posts are "U" shaped and are designed to fit .052 [1.32] diameter holes in an .062 [1.57] thick board.

The Right Angle Printed Circuit Connector is supplied in varied sizes and with preloaded contacts on one or both sides. The solder-type posts of the contacts are formed 90° from the housing to permit right angle interfacing between mother and daughter boards.

Features

- Connectors available for TERMI-POINT clip and wrap-type wiring, precision crimped terminations, soldered wire terminations, and solder dip applications.
- Contacts spaced on .156 [3.96] centers.
- Glass filled nylon, phenolic or diallyl phthalate housings.
- Closed card entry design prevents overstrapping of contacts.
- Gold-over-nickel plated contacts.
- Locking lance permits easy contact replacement.
- Keying.
- Contacts maintain exact pressures on the circuit paths, despite repeated insertions and extractions.

AMP-LEAF One-Piece Printed Circuit Edge Connectors

Dimensioning:

1. All dimensions in inches and millimetres. Values in brackets are metric equivalents.
2. Chart contains dimensions in inches over millimetres.

Crimp Snap-In Contacts

Material: Phosphor Bronze

Dummy Contact

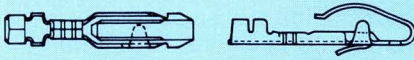

(Material: Phosphor Bronze)
Part No. 66084-1 Plain Finish
Part No. 66084-2 Tin Finish
Part No. 66084-3 Gold Finish

Commoning Spring

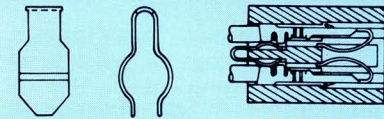

Made of gold plated beryllium copper. Only usable with insulation crimp height: .080-.085 [2.03-2.16]. Commoning spring should be inserted after terminals are in housing.
Part No. 66092-1 for .070-.055 [1.78-1.4] board thickness — **Part No. 66064-1** for .104-.084 [2.64-2.13] board thickness — **Part No. 583454-1**, with locking latches for .070-.055 [1.78-1.4] and .104-.084 [2.64-2.13] board thicknesses.

Note: Specifications subject to change. Consult AMP Incorporated for latest design specifications.

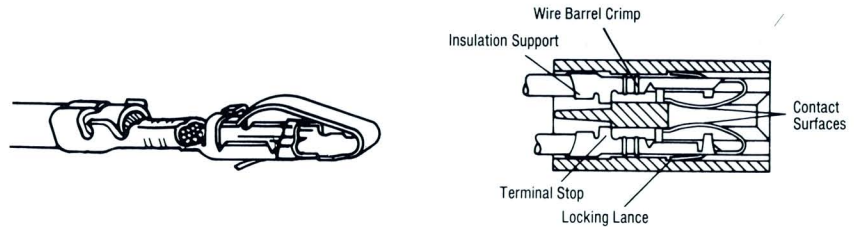

Wire Range	Insulation Range		Part No. Strip Form		Part No. Loose Piece		Finish	Housing used with
	Single Wire	Double Wire	For Standard Applicator	For Miniature Applicator	With Anti-Tangle Feature	Without Anti-Tangle Feature		
26-22	.050-.064 1.27-1.63	—	42702-2	583204-1	583990-2	42839-2	Tin*	All .070-.055 [1.78-1.4] thick Pc Boards
			42702-3	583204-2	583990-3	42839-3	Gold/Nickel ¹	
			42702-4	583204-3	583990-4	42839-4	Gold/Nickel ²	
			583267-2	—	583992-2	583268-2	Gold/Nickel [†]	
			583586-1	583586-2	—	—	Gold/Nickel ⁵	
			583586-3	583586-4	—	—	Gold/Nickel ⁶	
22-18	.055-.080 1.4-2.03	.120 3.05 Max.	42717-2	583361-2	583989-2	42840-2	Tin*	
			42717-3	583361-3	583989-3	42840-3	Gold/Nickel ¹	
			42717-4	583361-4	583989-4	42840-4	Gold/Nickel ²	
			42717-7	583361-5	583989-5	42840-7	Gold/Nickel ³	
22-18	.055-.080 1.4-2.03	—	583555-1	58555-2	—	—	Gold/Nickel ⁴	
			583555-3	58555-4	—	—	Gold/Nickel ⁵	
			583977-5 •	583977-4	—	—	Gold/Nickel ⁶	
			583983-1 •	—	—	—	Gold/Nickel ⁶	
16	.108 2.74 Max.	.160-.080 4.06-2.03	583271-2	583271-3	583994-2	583272-2	Gold/Nickel [†]	
			60151-2	—	583991-2	66028-2	Tin*	
			60151-3	60151-6	583991-3	66028-3	Gold/Nickel ¹	
			60151-5	60151-7	583991-4	66028-5	Gold/Nickel ²	
			583269-2	—	583993-2	583270-2	Gold/Nickel [†]	
			60029-2	—	—	60081-2	Tin*	
26-22	.050-.064 1.27-1.63	—	60029-3	—	—	60081-3	Gold/Nickel ¹	583399 and 582264 .104-.084 [2.64-2.13] thick Pc Boards
			60029-4	60029-5	—	60081-4	Gold/Nickel ²	
			60030-3	60030-5	—	60082-3	Gold/Nickel ¹	
22-18	.055-.080 1.4-2.03	.120 3.05 Max.	60030-4	—	—	60082-4	Gold/Nickel ²	

* Contact lubricant must be used.

† Beryllium copper contacts.

• Shorting contacts.

¹.000030 [0.00076] gold over .000100 [0.00254] nickel.

².000015 [0.00038] gold over .000030 [0.00076] nickel.

³.000060 [0.00152] gold over .000100 [0.00254] nickel.

⁴.000030 [0.00076] nickel on entire contact, .000010 [0.00025] gold on contact area only.

⁵.000030 [0.00076] nickel on entire contact, .000030 [0.00076] gold on contact area only.

⁶.000030 [0.00076] nickel on entire contact, .000015 [0.00038] gold on contact area only.

⁶ Gold flash over .000030 [0.00076] nickel on entire contact, .000030 [0.00076] gold on contact area only.

Note: Tin plated contacts have .000150-.000500 [0.00381-0.0127] tin over base metal.

AMP-LEAF One-Piece Printed Circuit Edge Connectors

Dimensioning:

1. All dimensions in inches and millimetres. Values in brackets are metric equivalents.
2. Chart contains dimensions in inches over millimetres.

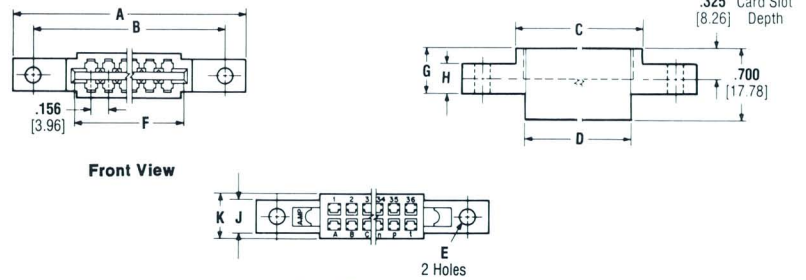

For use with .070-.055 [1.78-1.4] Thick Pc Boards

Glass Filled Nylon Housings

No. of Dual Pos.	Housing Part No.	Dimensions									
		A	B	C	D	E	F	G	H	J	K
6	583722-1	1.785	1.535	1.264	.976	.125	1.100	.456	.250	.300	.350
		45.34	38.99	32.11	24.79	3.18	27.94	11.58	6.35	7.62	8.89
10	583723-1	2.409	2.159	1.888	1.600	.125	1.724	.456	.250	.300	.350
		61.19	54.84	47.96	40.64	3.18	43.79	11.58	6.35	7.62	8.89
10	583960-1	2.409	2.159	1.888	1.600	.125	1.700	.456	.250	.300	.350
		61.19	54.84	47.96	40.64	3.18	43.18	11.58	6.35	7.62	8.89
12	583724-1	2.721	2.471	2.200	1.912	.125	2.036	.456	.250	.300	.350
		69.11	62.76	55.88	48.56	3.18	51.71	11.58	6.35	7.62	8.89
15	583554-1 ¹	—	—	2.668	2.380	—	2.504	—	—	—	.350
		—	—	67.77	60.45	—	63.6	—	—	—	8.89
15	583680-1	3.189	2.939	2.668	2.380	.128	2.504	.456	.250	.300	.350
		81	74.65	67.77	60.45	3.25	63.6	11.58	6.35	7.62	8.89
15	583952-1 ²	3.189	2.939	2.668	2.380	—	2.504	.456	.250	.300	.350
		81	74.65	67.77	60.45	—	63.6	11.58	6.35	7.62	8.89
18	583725-1	3.657	3.407	3.136	2.848	.125	2.972	.456	.250	.300	.350
		92.89	86.54	79.65	72.34	3.18	75.49	11.58	6.35	7.62	8.89
18	583725-3	3.657	3.407	3.136	2.848	.156	2.972	.456	.250	.300	.350
		92.89	86.54	79.65	72.34	3.96	75.49	11.58	6.35	7.62	8.89
22	583553-1 ¹	—	—	3.760	3.472	—	3.596	—	—	—	.350
		—	—	95.5	88.19	—	91.34	—	—	—	8.89
22	583617-1	4.281	4.031	3.760	3.472	.125	3.596	.456	.250	.300	.350
		108.74	102.39	95.5	88.19	3.18	91.34	11.58	6.35	7.62	8.89
22	583617-3	4.281	4.031	3.760	3.472	.156	3.596	.456	.250	.300	.350
		108.74	102.39	95.5	88.19	3.96	91.34	11.58	6.35	7.62	8.89
25	583726-1	4.749	4.499	4.228	3.940	.125	4.064	.456	.250	.300	.350
		120.62	114.27	107.39	100.01	3.18	103.23	11.58	6.35	7.62	8.89
30	583631-1	5.944	5.621	5.304	4.992	.178	*	.455	.290	.325	.437
		150.98	142.77	134.72	126.8	4.52	—	11.56	7.37	8.26	11.1
30	583685-1	5.529	5.279	5.008	4.720	.125	4.844	.456	.250	.300	.350
		140.44	134.09	127.2	119.89	3.18	123.04	11.58	6.35	7.62	8.89
30	583695-1 ¹	—	—	5.008	4.720	—	4.844	—	—	—	.350
		—	—	127.2	119.89	—	123.04	—	—	—	8.89
32	583742-1	6.365	5.928	5.292	5.072	.187	5.132	.455	.290	.325	.437
		161.67	150.57	134.42	128.83	4.75	130.35	11.56	7.37	8.26	11.1
36	530082-1	6.865	6.578	5.942	5.722	.156	5.782	.455	.290	.325	.437
		174.37	167.08	150.93	145.34	3.96	146.86	11.56	7.37	8.26	11.1
36	583552-1	7.015	6.578	5.942	5.722	.156	5.782	.455	.290	.325	.437
		178.18	167.08	150.93	145.34	3.96	146.86	11.56	7.37	8.26	11.1
36	583964-1 ¹	—	—	5.942	5.722	—	5.782	—	—	.325	.437
		—	—	150.93	145.34	—	146.86	—	—	8.26	11.1

*Dimensions for twin slot housing are the same as for Housing No. 480146-7 (page 4).

¹Housings without Mounting Ears

²Housing with Floating Bushings

AMP-LEAF One-Piece Printed Circuit Edge Connectors

Dimensioning:

1. All dimensions in inches and millimetres. Values in brackets are metric equivalents.
2. Chart contains dimensions in inches over millimetres.

Glass Filled Phenolic Housings For Crimp Snap-In Contacts

Material: Housing—Glass Filled Phenolic per MIL-M-14F

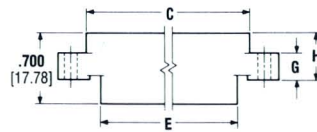
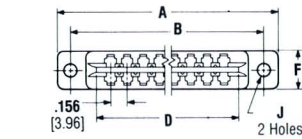

Single Slot Housing

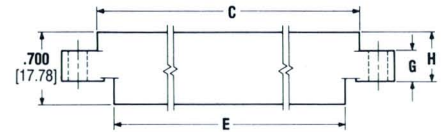
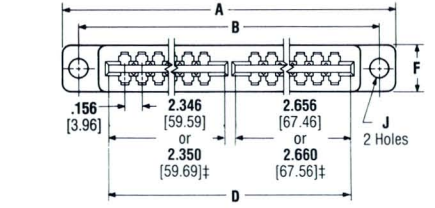

Twin Slot Housings (480146-7 and 583428-1**)

Glass Filled Phenolic Housings

No. of Dual Pos.	Housing Part No.	Dimensions									Board Thickness
		A	B	C	D	E	F	G	H	J	
8	582140-5	1.982	1.767	1.550	1.410	1.288	.340	.250	.458	.125	.070-.055
		50.34	44.88	39.37	35.81	32.72	8.64	6.35	11.63	3.18	1.78-1.4
10	582963-2	2.407	2.157	1.886	1.722	1.598	.360	.250	.456	.128	.070-.055
		61.14	54.79	47.9	43.74	40.59	9.14	6.35	11.58	3.25	1.78-1.4
10	583280-1 ¹	—	—	1.886	1.722	1.598	.360	—	—	—	.070-.055
				47.9	43.74	40.59	9.14				1.78-1.4
10	583463**	2.410	2.160	1.888	1.724	1.600	.360	.250	.456	.128	.070-.055
		61.21	54.86	47.96	43.79	40.64	9.14	6.35	11.58	3.25	1.78-1.4
12	583950-1	2.714	2.465	2.194	2.031	1.906	.350	.250	.456	.125	.070-.055
		68.94	62.61	55.73	51.59	48.41	8.89	6.35	11.58	3.18	1.78-1.4
15	480110-5	3.182	2.854	2.621	2.506	2.376	.350	.250	.466	.187	.070-.055
		80.82	72.49	66.57	63.65	60.35	8.89	6.35	11.84	4.75	1.78-1.4
15	1-582147-5	3.182	2.854	2.621	2.506	2.376	.350	.250	.466	.187	.070-.055
		80.82	72.49	66.57	63.65	60.35	8.89	6.35	11.84	4.75	1.78-1.4
15	582500-5	3.182	2.933	2.621	2.506	2.376	.350	.250	.466	.128	.070-.055
		80.82	74.5	66.57	63.65	60.35	8.89	6.35	11.84	3.25	1.78-1.4
18	480133-5	3.650	3.400	3.088	2.948	2.843	.375	.155	.406	.156	.070-.055
		92.71	86.36	78.44	74.88	72.21	9.53	3.94	10.31	3.96	1.78-1.4
18	480133-9	3.650	3.400	3.088	2.948	2.843	.375	.250	.406	.250	.070-.055
		92.71	86.36	78.44	74.88	72.21	9.53	6.35	10.31	6.35	1.78-1.4
18	1-582191-5	3.650	3.400	3.088	2.948	2.843	.375	.155	.406	.120	.070-.055
		92.71	86.36	78.44	74.88	72.21	9.53	3.94	10.31	3.05	1.78-1.4
18	583279-1	3.775	3.400	3.088	2.754	2.843	.375	.250	.406	.156	.070-.055
		95.89	86.36	78.44	69.95	72.21	9.53	6.35	10.31	3.96	1.78-1.4
18	583360-1**	3.656	3.406	3.093	2.953	2.843	.375	.250	.406	.156	.070-.055
		92.86	86.51	78.56	75.01	72.21	9.53	6.35	10.31	3.96	1.78-1.4
18	583399-3†*	4.025	3.525	3.089	2.950	2.868	.485	.290	.455	.281	.104-.084
		102.24	89.54	78.46	74.93	72.85	12.32	7.37	11.56	7.14	2.64-2.13
22	480142-3	4.274	4.025	3.754	3.591	3.466	.350	.250	.456	.125	.070-.055
		108.56	102.24	95.35	91.21	88.04	8.89	6.35	11.58	3.18	1.78-1.4
22	582358-3	4.274	4.025	3.754	3.591	3.466	.350	.250	.456	.150	.070-.055
		108.56	102.24	95.35	91.21	88.04	8.89	6.35	11.58	3.81	1.78-1.4
22	583273-5**	4.281	4.031	3.760	3.596	3.472	.350	.250	.456	.125	.070-.055
		108.74	102.39	95.5	91.34	88.19	8.89	6.35	11.58	3.18	1.78-1.4
25	583167-3	4.741	4.493	4.221	4.058	3.933	.350	.250	.456	.125	.070-.055
		120.42	114.12	107.21	103.07	99.9	8.89	6.35	11.58	3.18	1.78-1.4
28	583637-1	5.210	4.961	4.690	4.527	4.402	.350	.250	.456	.128	.070-.055
		132.33	126.01	119.13	114.99	111.81	8.89	6.35	11.58	3.25	1.78-1.4
30	480146-7	5.944	5.621	5.304	5.101	4.992	.437	.290	.455	.178	.070-.055
		150.98	142.77	134.72	129.57	126.8	11.1	7.37	11.56	4.52	1.78-1.4
30	583428-1**	5.953	5.630	5.312	5.109	5.000	.437	.290	.455	.178	.070-.055
		151.21	143	134.92	129.77	127	11.1	7.37	11.56	4.52	1.78-1.4
32	582264-2†	6.365	5.928	5.292	5.132	5.072	.485	.290	.455	.187	.104-.084
		161.67	150.57	134.42	130.35	128.83	12.32	7.37	11.56	4.75	2.64-2.13
32	583449-1**	6.375	5.937	5.300	5.140	4.080	.485	.290	.455	.187	.104-.084
		161.93	150.8	134.62	130.56	103.63	12.32	7.37	11.56	4.75	2.64-2.13

†Does not accommodate Inter-Contact Keying Plug.

‡This dimension applies only to Housing No. 583428-1.

**Housing designed to accept .104-.084 [2.64-2.13] Printed Circuit Board.

**Housing Color—Green.

¹Housing without Mounting Ears.

Dimensioning:

1. All dimensions in inches and millimetres. Values in brackets are metric equivalents.
2. Chart contains dimensions in inches over millimetres.

AMP-LEAF One-Piece Printed Circuit Edge Connectors

Diallyl Phthalate Housings For Crimp Snap-In Contacts

Material: Housing—Diallyl Phthalate per MIL-M-14F

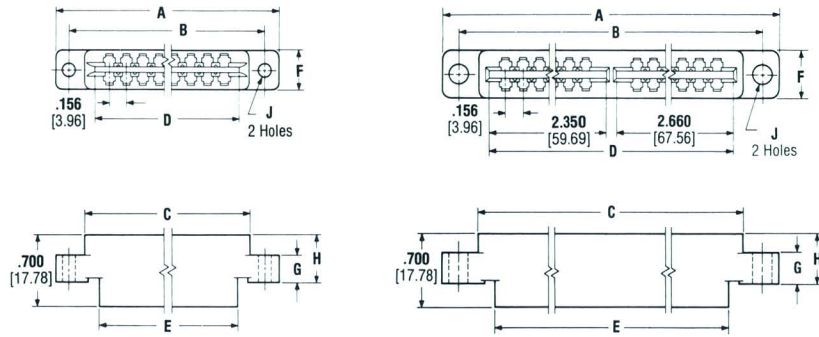

Single Slot Housing

Twin Slot Housing (480146-2 only)

Diallyl Phthalate Housings

No. of Dual Pos.	Housing Part No.	Dimensions									Board Thickness
		A	B	C	D	E	F	G	H	J	
8	582140-2	1.985	1.770	1.552	1.412	1.290	.340	.250	.458	.125	.070-.055
		50.42	44.96	39.42	35.86	32.77	8.64	6.35	11.63	3.18	1.78-1.4
10	582963-4	2.410	2.160	1.888	1.724	1.600	.360	.250	.456	.128	.070-.055
		61.21	54.86	47.96	43.79	40.64	9.14	6.35	11.58	3.25	1.78-1.4
15	1-582147-2	3.187	2.859	2.625	2.510	2.380	.350	.250	.466	.128	.070-.055
		80.95	72.62	66.68	63.75	60.45	8.89	6.35	11.84	3.25	1.78-1.4
15	480110-2	3.187	2.859	2.625	2.510	2.380	.350	.250	.466	.187	.070-.055
		80.95	72.62	66.68	63.75	60.45	8.89	6.35	11.84	4.15	1.78-1.4
15	582500-2	3.187	2.938	2.625	2.510	2.380	.350	.250	.466	.128	.070-.055
		80.95	74.63	66.68	63.75	60.45	8.89	6.35	11.84	3.25	1.78-1.4
15	583512-1 ¹	—	—	2.625	2.510	2.380	—	—	.435	—	.070-.055
				66.68	63.75	60.45			11.05		1.78-1.4
18	480133-2	3.656	3.406	3.093	2.953	2.848	.375	.155	.406	.156	.070-.055
		92.86	86.51	78.56	75.01	72.34	9.53	3.94	10.31	3.96	1.78-1.4
18	480133-7	3.656	3.406	3.093	2.953	2.848	.375	.250	.406	.156	.070-.055
		92.86	86.51	78.56	75.01	72.34	9.53	6.35	10.31	3.96	1.78-1.4
18	1-582191-2	3.656	3.406	3.093	2.953	2.848	.375	.155	.406	.120	.070-.055
		92.86	86.51	78.56	75.01	72.34	9.53	3.94	10.31	3.05	1.78-1.4
18	583399-1†	4.031	3.531	3.094	2.955	2.873	.485	.290	.455	.281	.104-.084
		102.39	89.69	78.59	75.06	72.97	12.32	7.37	11.56	7.14	2.64-2.13
18	583716-1 ²	3.656	3.406	3.093	2.953	2.848	.375	.250	.406	*	.070-.055
		92.86	86.51	78.56	75.01	72.34	9.53	6.35	10.31		1.78-1.4
22	480142-2	4.281	4.031	3.760	3.596	3.472	.350	.250	.456	.125	.070-.055
		108.74	102.39	95.9	91.34	88.19	8.89	6.35	11.58	3.18	1.78-1.4
22	582358-2	4.281	4.031	3.760	3.596	3.472	.350	.250	.456	.150	.070-.055
		108.74	102.39	95.5	91.34	88.19	8.89	6.35	11.58	3.81	1.78-1.4
22	582627-1 ²	4.281	4.031	3.760	3.596	3.472	.375	.250	.456	*	.070-.055
		108.74	102.39	95.5	91.34	88.19	9.53	6.35	11.58		1.78-1.4
25	583167-1	4.749	4.500	4.228	4.064	3.940	.350	.250	.456	.125	.070-.055
		120.62	114.3	107.39	103.23	100.08	8.89	6.35	11.58	3.18	1.78-1.4
30	480146-2	5.953	5.630	5.312	5.109	5.000	.437	.290	.455	.178	.070-.055
		151.21	143	134.92	129.77	127	11.1	7.37	11.56	4.52	1.78-1.4
32	582264-5	6.375	5.937	5.300	5.140	5.080	.485	.290	.455	.187	.104-.084
		161.93	150.8	134.62	130.56	129.03	12.32	7.37	11.56	4.75	2.64-2.13

†Does not accommodate Inter-Contact Keying Plug.

*4-40 UNC Inserts.

¹Housing without Mounting Ears.

²Housings with Threaded Inserts.

AMP-LEAF One-Piece Printed Circuit Edge Connectors

Dimensioning:

1. All dimensions in inches and millimetres. Values in brackets are metric equivalents.
2. Charts contain dimensions in inches over millimetres.

Housings Preloaded with Post Type Contacts

(Board Thickness .070-.055 [1.78-1.4])

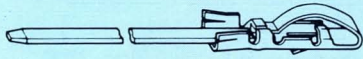

Post Length L	Loose Piece Contact Part No.		No. of TERMI-POINT Clips or Wraps per Post
	.031 x .062 [0.79 x 1.57] Post	.045 x .045 [1.14 x 1.14] Post	
.960 24.38	1-582391-3	1-582355-3	4
.760 19.3	1-582391-4	1-582355-4	3
.560 14.22	1-582391-5	1-582355-5	2
.360 9.14	1-582391-6	1-582355-6	1

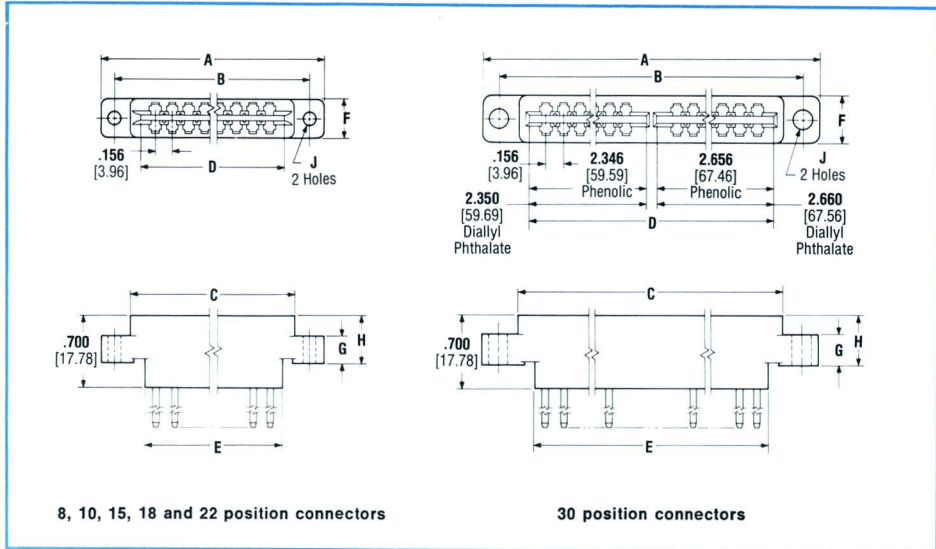

Glass Filled Phenolic Housings

No. of Dual Pos.	Length of Posts L	Loading—(X) Two Sides (Y) One Side				Dimensions									
		.062 x .031 [1.57 x 0.79] Posts		.045 x .045 [1.14 x 1.14] Posts		A	B	C	D	E	F	G	H	J	
		X	Y	X	Y										
8	.960 24.38	582761-1	582761-5	582781-1	582781-5	1.982 50.34	1.767 44.88	1.550 39.37	1.410 35.81	1.288 32.72	.340 8.64	.250 6.35	.458 11.63	.125 3.18	
	.760 19.3	582761-2	582761-6	582781-2	582781-6	1.982 50.34	1.767 44.88	1.550 39.37	1.410 35.81	1.288 32.72	.340 8.64	.250 6.35	.458 11.63	.125 3.18	
	.560 14.22	582761-3	582761-7	582781-3	582781-7	1.982 50.34	1.767 44.88	1.550 39.37	1.410 35.81	1.288 32.72	.340 8.64	.250 6.35	.458 11.63	.125 3.18	
	.360 9.14	582761-4	582761-8	582781-4	582781-8	1.982 50.34	1.767 44.88	1.550 39.37	1.410 35.81	1.288 32.72	.340 8.64	.250 6.35	.458 11.63	.125 3.18	
10	.960 24.38	582962-4	582962-8	—	—	2.407 61.14	2.157 54.79	1.886 47.9	1.722 43.74	1.598 40.59	.360 9.14	.250 6.35	.456 11.58	.128 3.25	
	.760 19.3	582962-1	582962-5	—	—	2.407 61.14	2.157 54.79	1.886 47.9	1.722 43.74	1.598 40.59	.360 9.14	.250 6.35	.456 11.58	.128 3.25	
	.560 14.22	582962-2	582962-6	—	—	2.407 61.14	2.157 54.79	1.886 47.9	1.722 43.74	1.598 40.59	.360 9.14	.250 6.35	.456 11.58	.128 3.25	
	.360 9.14	582962-3	582962-7	—	—	2.407 61.14	2.157 54.79	1.886 47.9	1.722 43.74	1.598 40.59	.360 9.14	.250 6.35	.456 11.58	.128 3.25	
15	.960 24.38	582763-1	582763-5	582783-1	582783-5	3.182 80.82	2.854 72.49	2.621 66.57	2.506 63.65	2.376 60.35	.350 8.89	.250 6.35	.466 11.84	.128 3.25	
	.760 19.3	582763-2	582763-6	582783-2	582783-6	3.182 80.82	2.854 72.49	2.621 66.57	2.506 63.65	2.376 60.35	.350 8.89	.250 6.35	.466 11.84	.128 3.25	
	.560 14.22	582763-3	582763-7	582783-3	582783-7	3.182 80.82	2.854 72.49	2.621 66.57	2.506 63.65	2.376 60.35	.350 8.89	.250 6.35	.466 11.84	.128 3.25	
	.360 9.14	582763-4	582763-8	582783-4	582783-8	3.182 80.82	2.854 72.49	2.621 66.57	2.506 63.65	2.376 60.35	.350 8.89	.250 6.35	.466 11.84	.128 3.25	
18	.960 24.38	582765-1	582765-5	582785-1	582785-5	3.650 92.71	3.400 86.36	3.088 78.44	2.951 74.96	2.843 72.21	.375 9.53	.250 6.35	.406 10.31	.120 3.05	
	.760 19.3	582765-2	582765-6	582785-2	582785-6	3.650 92.71	3.400 86.36	3.088 78.44	2.951 74.96	2.843 72.21	.375 9.53	.250 6.35	.406 10.31	.120 3.05	
	.560 14.22	582765-3	582765-7	582785-3	582785-7	3.650 92.71	3.400 86.36	3.088 78.44	2.951 74.96	2.843 72.21	.375 9.53	.250 6.35	.406 10.31	.120 3.05	
	.360 9.14	582765-4	582765-8	582785-4	582785-8	3.650 92.71	3.400 86.36	3.088 78.44	2.951 74.96	2.843 72.21	.375 9.53	.250 6.35	.406 10.31	.120 3.05	
22	.960 24.38	582767-1	582767-5	582787-1	582787-5	4.274 108.56	4.025 102.24	3.754 95.35	3.591 91.21	3.466 88.04	.350 8.89	.250 6.35	.456 11.58	.125 3.25	
	.760 19.3	582767-2	582767-6	582787-2	582787-6	4.274 108.56	4.025 102.24	3.754 95.35	3.591 91.21	3.466 88.04	.350 8.89	.250 6.35	.456 11.58	.125 3.25	
	.560 14.22	582767-3	582767-7	582787-3	582787-7	4.274 108.56	4.025 102.24	3.754 95.35	3.591 91.21	3.466 88.04	.350 8.89	.250 6.35	.456 11.58	.125 3.25	
	.360 9.14	582767-4	582767-8	582787-4	582787-8	4.274 108.56	4.025 102.24	3.754 95.35	3.591 91.21	3.466 88.04	.350 8.89	.250 6.35	.456 11.58	.125 3.25	
30†	.960 24.38	582769-1	582769-5	582789-1	582789-5	5.944 150.98	5.621 142.77	5.304 134.72	5.101 129.57	4.992 126.8	.437 11.1	.290 7.37	.455 11.56	.178 4.52	
	.760 19.3	582769-2	582769-6	582789-2	582789-6	5.944 150.98	5.621 142.77	5.304 134.72	5.101 129.57	4.992 126.8	.437 11.1	.290 7.37	.455 11.56	.178 4.52	
	.560 14.22	582769-3	582769-7	582789-3	582789-7	5.944 150.98	5.621 142.77	5.304 134.72	5.101 129.57	4.992 126.8	.437 11.1	.290 7.37	.455 11.56	.178 4.52	
	.360 9.14	582769-4	582769-8	582789-4	582789-8	5.944 150.98	5.621 142.77	5.304 134.72	5.101 129.57	4.992 126.8	.437 11.1	.290 7.37	.455 11.56	.178 4.52	

Note: Posts meet the requirements for wrap type or AMP TERMI-POINT Clip Application.
 8, 10, 15, 18 and 22 position connectors loaded one side (Y) on numbered side of connector, 30 position loaded one side at position 31 thru 60.
 †30 Dual-position connector has additional dimensions as shown in drawing above.

Dimensioning:

- All dimensions in inches and millimetres. Values in brackets are metric equivalents.
- Charts contain dimensions in inches over millimetres.

AMP-LEAF One-Piece Printed Circuit Edge Connectors

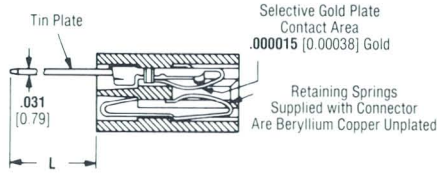

Loaded One Side (Y)
Other plating thicknesses available upon request

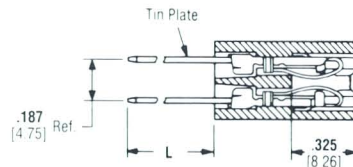

Loaded Two Sides (X)

Diallyl Phthalate Housings

No. of Dual Pos.	Length of Posts L	Loading—(X) Two Sides (Y) One Side				Dimensions									
		.062 x .031 [1.57 x 0.79] Posts		.045 x .045 [1.14 x 1.14] Posts		A	B	C	D	E	F	G	H	J	
		X	Y	X	Y										
8	.960 24.38	582760-1	582760-5	582780-1	582780-5	1.985 50.42	1.770 44.96	1.552 39.42	1.412 35.86	1.290 32.77	.340 8.64	.250 6.35	.458 11.63	.125 3.18	
	.760 19.3	582760-2	582760-6	582780-2	582780-6	1.985 50.42	1.770 44.96	1.552 39.42	1.412 35.86	1.290 32.77	.340 8.64	.250 6.35	.458 11.63	.125 3.18	
	.560 14.22	582760-3	582760-7	582780-3	582780-7	1.985 50.42	1.770 44.96	1.552 39.42	1.412 35.86	1.290 32.77	.340 8.64	.250 6.35	.458 11.63	.125 3.18	
	.360 9.14	582760-4	582760-8	582780-4	582780-8	1.985 50.42	1.770 44.96	1.552 39.42	1.412 35.86	1.290 32.77	.340 8.64	.250 6.35	.458 11.63	.125 3.18	
15	.960 24.38	582762-1	582762-5	582782-1	582782-5	3.187 80.95	2.859 72.62	2.625 66.68	2.510 63.75	2.380 60.45	.350 8.89	.250 6.35	.466 11.84	.128 3.25	
	.760 19.3	582762-2	582762-6	582782-2	582782-6	3.187 80.95	2.859 72.62	2.625 66.68	2.510 63.75	2.380 60.45	.350 8.89	.250 6.35	.466 11.84	.128 3.25	
	.560 14.22	582762-3	582762-7	582782-3	582782-7	3.187 80.95	2.859 72.62	2.625 66.68	2.510 63.75	2.380 60.45	.350 8.89	.250 6.35	.466 11.84	.128 3.25	
	.360 9.14	582762-4	582762-8	582782-4	582782-8	3.187 80.95	2.859 72.62	2.625 66.68	2.510 63.75	2.380 60.45	.350 8.89	.250 6.35	.466 11.84	.128 3.25	
18	.960 24.38	582764-1	582764-5	582784-1	582784-5	3.656 92.86	3.406 86.51	3.093 78.56	2.953 75	2.848 72.34	.375 9.53	.250 6.35	.406 10.31	.120 3.05	
	.760 19.3	582764-2	582764-6	582784-2	582784-6	3.656 92.86	3.406 86.51	3.093 78.56	2.953 75	2.848 72.34	.375 9.53	.250 6.35	.406 10.31	.120 3.05	
	.560 14.22	582764-3	582764-7	582784-3	582784-7	3.656 92.86	3.406 86.51	3.093 78.56	2.953 75	2.848 72.34	.375 9.53	.250 6.35	.406 10.31	.120 3.05	
	.360 9.14	582764-4	582764-8	582784-4	582784-8	3.656 92.86	3.406 86.51	3.093 78.56	2.953 75	2.848 72.34	.375 9.53	.250 6.35	.406 10.31	.120 3.05	
22	.960 24.38	582766-1	582766-5	582786-1	582786-5	4.281 108.74	4.031 102.39	3.760 95.5	3.596 91.34	3.472 88.19	.350 8.89	.250 6.35	.456 11.58	.125 3.18	
	.760 19.3	582766-2	582766-6	582786-2	582786-6	4.281 108.74	4.031 102.39	3.760 95.5	3.596 91.34	3.472 88.19	.350 8.89	.250 6.35	.456 11.58	.125 3.18	
	.560 14.22	582766-3	582766-7	582786-3	582786-7	4.281 108.74	4.031 102.39	3.760 95.5	3.596 91.34	3.472 88.19	.350 8.89	.250 6.35	.456 11.58	.125 3.18	
	.360 9.14	582766-4	582766-8	582786-4	582786-8	4.281 108.74	4.031 102.39	3.760 95.5	3.596 91.34	3.472 88.19	.350 8.89	.250 6.35	.456 11.58	.125 3.18	
30†	.960 24.38	582768-1	582768-5	582788-1	582788-5	5.953 151.21	5.630 143	5.312 134.92	5.109 129.77	5.000 127	.437 11.1	.290 7.37	.455 11.56	.178 4.52	
	.760 19.3	582768-2	582768-6	582788-2	582788-6	5.953 151.21	5.630 143	5.312 134.92	5.109 129.77	5.000 127	.437 11.1	.290 7.37	.455 11.56	.178 4.52	
	.560 14.22	582768-3	582768-7	582788-3	582788-7	5.953 151.21	5.630 143	5.312 134.92	5.109 129.77	5.000 127	.437 11.1	.290 7.37	.455 11.56	.178 4.52	
	.360 9.14	582768-4	582768-8	582788-4	582788-8	5.953 151.21	5.630 143	5.312 134.92	5.109 129.77	5.000 127	.437 11.1	.290 7.37	.455 11.56	.178 4.52	

Glass Filled Nylon Housings

8	.760 19.3	—	530073-1	—	—	1.785 45.34	1.535 38.99	1.264 32.11	1.100 27.94	.976 24.79	.350 8.89	.250 6.35	.456 11.58	.125 3.18
10	.590 14.99	—	—	530074-1	—	2.409 61.19	2.159 54.84	1.844 46.84	1.700 43.18	1.600 40.64	.350 8.89	.250 6.35	.456 11.58	.125 3.18
12	.560 14.22	530089-1	—	—	—	2.714 68.94	2.465 62.61	2.194 55.73	2.031 51.59	1.906 48.41	.350 8.89	.250 6.35	.456 11.58	.125 3.18
	.360 9.14	583632-4	583632-8	—	—	5.529 140.44	5.279 134.09	5.008 127.2	4.844 123.04	4.720 119.89	.350 8.89	.250 6.35	.456 11.58	.125 3.18
	.560 14.22	583632-3	583632-7	—	—	5.529 140.44	5.279 134.09	5.008 127.2	4.844 123.04	4.720 119.89	.350 8.89	.250 6.35	.456 11.58	.125 3.18
	.760 19.3	583632-2	583632-6	—	—	5.529 140.44	5.279 134.09	5.008 127.2	4.844 123.04	4.720 119.89	.350 8.89	.250 6.35	.456 11.58	.125 3.18
30†	.960 24.38	583632-1	583632-5	—	—	5.529 140.44	5.279 134.09	5.008 127.2	4.844 123.04	4.720 119.89	.350 8.89	.250 6.35	.456 11.58	.125 3.18
	.760 19.3	—	—	530410-1	—	6.365 161.67	5.928 150.57	5.292 134.42	5.132 130.35	5.072 128.83	.437 11.1	.250 6.35	.455 11.56	.187 4.75
36	.360 9.14	583611-3	—	—	—	7.015 178.18	6.578 167.08	5.942 150.93	5.782 146.86	5.722 145.34	.437 11.1	.290 7.37	.455 11.56	.156 3.96
	.560 14.22	583611-2	—	—	—	7.015 178.18	6.578 167.08	5.942 150.93	5.782 146.86	5.722 145.34	.437 11.1	.290 7.37	.455 11.56	.156 3.96
	.760 19.3	583611-1	—	—	—	7.015 178.18	6.578 167.08	5.942 150.93	5.782 146.86	5.722 145.34	.437 11.1	.290 7.37	.455 11.56	.156 3.96

Note: Posts meet the requirements for wrap type or AMP TERMI-POINT Clip Application.
8, 10, 12, 15, 18 and 22 position connectors loaded one side (Y) on numbered side of connector, 30 position loaded one side at position 31 thru 60.
†30 Dual-position connector has additional dimensions as shown in drawing above.

AMP-LEAF One-Piece Printed Circuit Edge Connectors

Dimensioning:

1. All dimensions in inches and millimetres. Values in brackets are metric equivalents.
2. Charts contain dimensions in inches over millimetres.

Housings Preloaded with Eyelet Type Contacts

(Board Thickness .070-.055 [1.78-1.4])

Contact Types

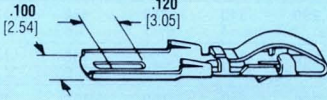

TYPE A
Standard Eyelet Type Contact
Part No. 66067-5

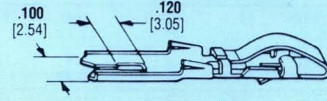

TYPE B
Split Eyelet Type Contact
Part No. 66214-4

Tab will accommodate a maximum of two-#16 solid wires or a maximum of two-#18 stranded wires (Type A only). All contacts nickel base plate. Solder tabs gold flash all over with .00015 [0.00038] gold on contact areas only.

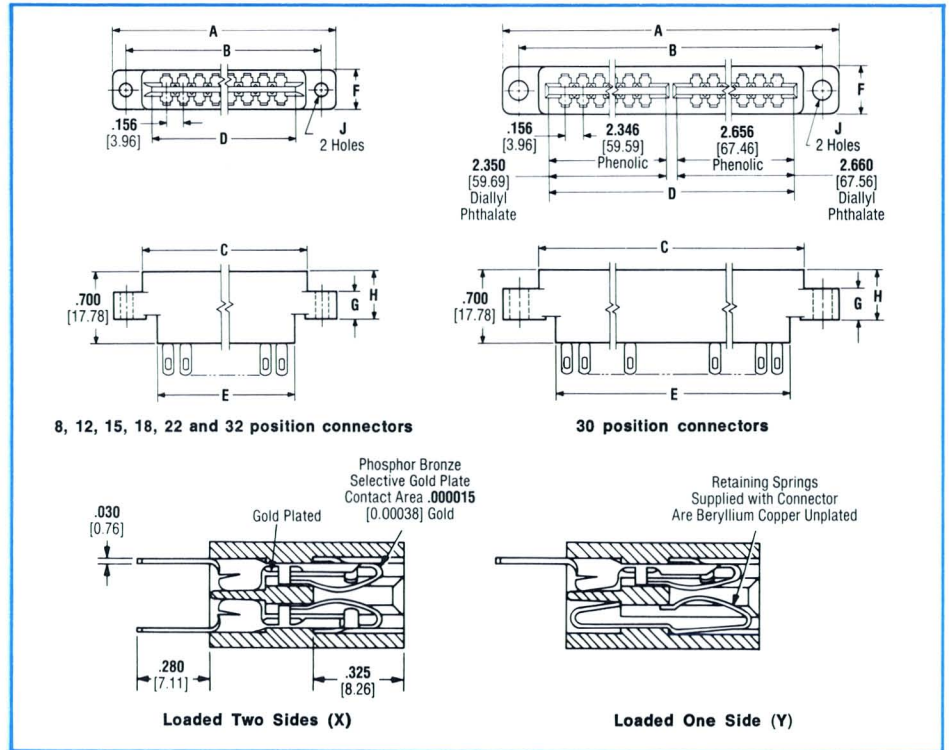

Phenolic Housings

No. of Dual Pos.	Contact Type	Part Numbers		Dimensions								
		Loaded Two Sides (X)	Loaded One Side (Y)	A	B	C	D	E	F	G	H	J
8	A	582771-1	582771-2	1.982	1.767	1.550	1.410	1.288	.340	.250	.458	.125
	B	582771-3	582771-4	50.34	44.88	39.37	35.81	32.72	8.64	6.35	11.63	3.18
12	B	583970-1	583970-2	2.714	2.465	2.194	2.031	1.906	.350	.250	.456	.125
		582773-3	582773-4	68.94	62.61	55.73	51.59	48.41	8.89	6.35	11.58	3.18
15	A	582773-1	582773-2	3.182	2.854	2.621	2.506	2.376	.350	.250	.466	.128
	B	582773-3	582773-4	80.82	72.49	66.57	63.65	60.35	8.89	6.35	11.84	3.25
18	A	582775-1	582775-2	3.650	3.400	3.088	2.948	2.843	.375	.250	.406	.120
	B	582775-3	582775-4	92.71	86.36	78.44	74.88	72.21	9.53	6.35	10.31	3.05
22	A	582777-1	582777-2	4.274	4.025	3.754	3.591	3.466	.350	.250	.456	.125
	B	582777-3	582777-4	108.56	102.24	95.35	91.21	88.04	8.89	6.35	11.58	3.18
30†	A	582779-1	582779-2	5.944	5.621	5.304	5.101	4.992	.437	.290	.455	.178
	B	582779-3	582779-4	150.98	142.77	134.72	129.57	126.8	11.1	7.37	11.56	4.52
32°	A	583965-1	—	6.365	5.928	5.292	5.132	5.072	.485	.290	.455	.187
				161.67	150.57	134.42	130.35	128.83	12.32	7.37	11.56	4.75

Diallyl Phthalate Housings

8	A	582770-1	582770-2	1.985	1.770	1.552	1.412	1.290	.340	.250	.458	.125
	B	582770-3	582770-4	50.42	44.96	39.42	35.86	32.77	8.64	6.35	11.63	3.18
15	A	582772-1	582772-2	3.187	2.859	2.625	2.510	2.380	.350	.250	.466	.128
	B	582772-3	582772-4	80.95	72.62	66.68	63.75	60.45	8.89	6.35	11.84	3.25
18	A	582774-1	582774-2	3.656	3.406	3.093	2.953	2.848	.375	.250	.406	.120
	B	582774-3	582774-4	92.86	86.51	78.56	75.01	72.34	9.53	6.35	10.31	3.05
22	A	582776-1	582776-2	4.281	4.031	3.760	3.596	3.472	.350	.250	.456	.125
	B	582776-3	582776-4	108.74	102.39	95.5	91.34	88.19	8.89	6.35	11.58	3.18
30†	A	582778-1	582778-2	5.953	5.630	5.312	5.109	5.000	.437	.290	.455	.178
	B	582778-3	582778-4	151.13	143.	134.92	129.77	127.	11.1	7.37	11.56	4.52
32°	A	—	530099-1	6.365	5.928	5.292	5.132	5.072	.485	.290	.455	.187
				161.67	150.57	134.42	130.35	128.83	12.32	7.37	11.56	4.75

Note: All assemblies, except 8 position, loaded one side only will have an appropriate quantity of retaining springs. 8, 15, 18 and 22 position connectors loaded one side (Y) on numbered side of connector, 30 position loaded one side at position 31 thru 60.

†30 Dual-position connector has additional dimensions as shown in drawing above.

*For .104-.084 [2.64-2.13] Printed Circuit Board.

AMP-LEAF One-Piece Printed Circuit Edge Connectors

Dimensioning:

1. All dimensions in inches and millimetres. Values in brackets are metric equivalents.
2. Chart contains dimensions in inches over millimetres.

Housings Preloaded with Solder Tab Contacts For .062 [1.57] Thick Pc Boards

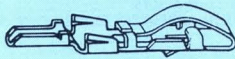

Contact Part No. 583294-2

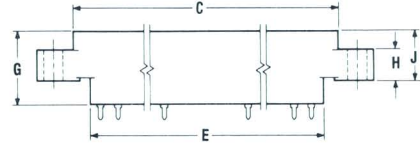
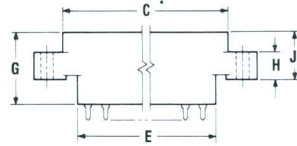
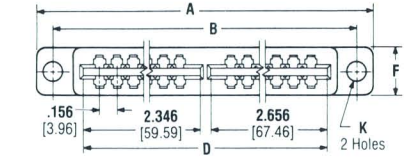
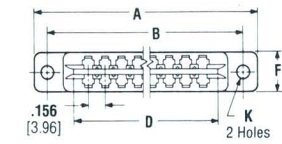

8, 10, 12, 15, 18, 22 and 36 position connectors

30 position connectors

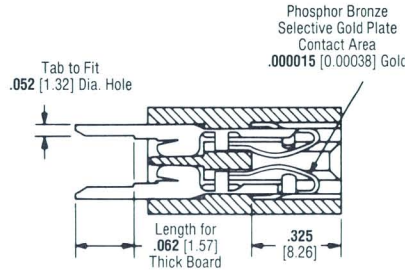

Loaded Two Sides (X)

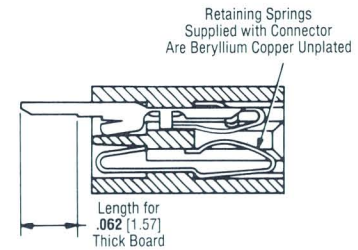

Loaded One Side (Y)

No. of Dual Pos.	Part Nos.	Loading: Two Sides (X) One Side (Y)	Dimensions										Housing Material
			A	B	C	D	E	F	G	H	J	K	
8	583331-1	X	1.982 50.34	1.767 44.88	1.550 39.37	1.410 35.81	1.288 32.72	.340 8.64	.700 17.78	.250 6.35	.458 11.63	.125 3.18	Phenolic
	583331-2	Y											
10	583332-1	X	2.407 61.14	2.157 54.79	1.886 47.9	1.722 43.74	1.598 40.59	.360 9.14	.700 17.78	.250 6.35	.456 11.58	.128 3.25	Phenolic
	583332-2	Y											
12	583972-1	X	2.714 68.94	2.465 62.61	2.194 55.73	2.031 51.59	1.906 48.41	.350 8.89	.700 17.78	.250 6.35	.456 11.58	.125 3.18	Phenolic
	583333-1	X	3.182 80.82	2.854 72.49	2.621 66.57	2.506 63.65	2.376 60.35	.350 8.89	.700 17.78	.250 6.35	.466 11.84	.128 3.25	
15	583333-2	Y											Phenolic
	530418-1	X	3.189 81	2.939 74.65	2.668 67.77	2.504 63.6	2.308 58.62	.350 8.89	.700 17.78	.250 6.35	.456 11.58	.128 3.25	
18	583334-1	X	3.650 92.71	3.400 86.36	3.088 78.44	2.948 74.88	2.843 72.21	.375 9.53	.700 17.78	.250 6.35	.406 10.31	.120 3.05	Phenolic
	583334-2	Y											
18	530400-1†	X	4.025 102.24	3.525 89.54	3.089 78.46	2.950 74.93	2.868 72.85	.485 12.32	.700 17.78	.290 7.37	.455 11.56	.281 7.14	Glass Filled Nylon
	530437-1*	X	3.650 92.71	3.400 86.36	3.088 78.44	2.948 74.88	2.843 72.21	.375 9.53	.700 17.78	.250 6.35	.406 10.31	*	
22	583335-1	X	4.274 108.56	4.025 102.24	3.754 95.35	3.591 91.21	3.466 88.19	.350 8.89	.700 17.78	.250 6.35	.455 11.56	.125 3.18	Phenolic
	583335-2	Y											
22	583971-1	X	4.281 108.74	4.031 102.39	3.760 95.5	3.596 91.34	3.472 88.19	.350 8.89	.700 17.78	.250 6.35	.456 11.58	.125 3.18	Glass Filled Nylon
	530434-1*	X	4.281 108.74	4.031 102.39	3.760 95.5	3.596 91.34	3.472 88.19	.350 8.89	.700 17.78	.250 6.35	.456 11.58	*	
30	583336-1	X	5.944 150.98	5.621 142.77	5.304 134.72	5.101 129.57	4.992 126.8	.437 11.1	.700 17.78	.290 7.37	.455 11.56	.178 4.52	Phenolic
	583336-2	Y											
30	530412-1*	X	5.944 150.98	5.621 142.77	5.304 134.72	5.101 129.57	4.992 126.8	.437 11.1	.700 17.78	.290 7.37	.455 11.56	*	Glass Filled Nylon
	530080-1	X	7.015 178.18	6.578 167.08	5.942 150.93	5.782 146.86	5.722 145.34	.437 11.1	.700 17.78	.290 7.37	.455 11.56	.156 3.96	

*4-40 UNC Inserts.

†.104-.084 [2.64-2.13] Thick Pc Board.

AMP-LEAF One-Piece Printed Circuit Edge Connectors

Dimensioning:

1. All dimensions in inches and millimetres. Values in brackets are metric equivalents.
2. Chart contains dimensions in inches over millimetres.

Housings Preloaded with Right Angle Type Contacts

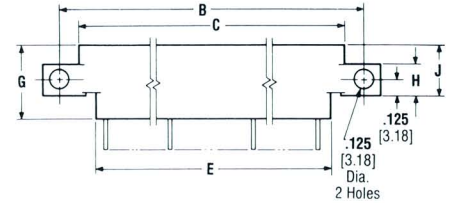
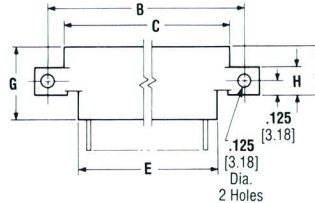
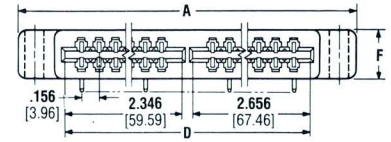
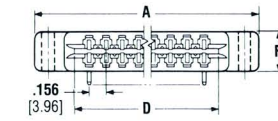

8, 10, 15, 18, 22, 25, 28 and 32 position connectors
Housing Material—Phenolic

30 position connectors
except Part No. 530092-1 (single card slot)

Post Contact
.022 x .036 [0.56 x 0.91]
Phosphor Bronze
Tin Plated

Phosphor Bronze
Selective Gold Plate
Contact Area
.000015 [0.00038] Gold

Retaining Springs
Supplied with Connector
Are Beryllium Copper
Unplated

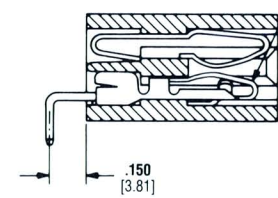
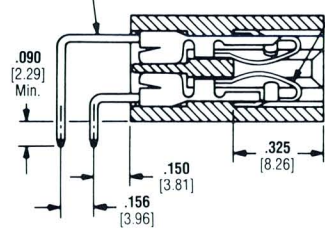

Loaded Two Sides (X)

Loaded One Side (Y)

No. of Dual Pos.	Part Nos.	Loading: Two Sides (X) One Side (Y)	Dimensions								
			A	B	C	D	E	F	G	H	J
8	583598-1	X	1.982	1.767	1.550	1.410	1.288	.340	.700	.250	.458
	583598-2	Y	50.34	44.88	39.37	35.81	32.72	8.64	17.78	6.35	11.63
10	583599-1	X	2.407	2.157	1.886	1.722	1.598	.360	.700	.250	.456
	583599-2	Y	61.14	54.79	47.9	43.74	40.59	9.14	17.78	6.35	11.58
15	530421-1**	X	3.187	2.938	2.625	2.510	2.380	.350	.700	.250	.466
	583545-1	X	80.95	74.63	66.68	63.75	60.45	8.89	17.78	6.35	11.84
15	583545-2	Y	3.182	2.933	2.621	2.506	2.376	.350	.700	.250	.466
	583545-1	Y	80.82	74.5	66.57	63.65	60.35	8.89	17.78	6.35	11.84
18	583544-1	X	3.650	3.400	3.088	2.948	2.843	.375	.700	.250	.406
	583544-2	X	92.71	86.36	78.44	74.88	72.21	9.53	17.78	6.35	10.31
22	583544-3	X†									
	583458-2	X	4.274	4.025	3.754	3.591	3.466	.350	.700	.250	.456
22	583458-1	Y	108.56	102.24	95.35	91.21	88.04	8.89	17.78	6.35	11.58
	583975-1*	X	4.281	4.031	3.760	3.596	3.472	.350	.700	.250	.456
25	583600-1	X	108.74	102.39	95.5	91.34	88.19	8.89	17.78	6.35	11.58
	583600-2	Y	4.741	4.493	4.221	4.058	3.933	.350	.700	.250	.456
25	583600-3	X [▲]	120.42	114.12	107.21	103.07	99.9	8.89	17.78	6.35	11.58
	530061-1	X	5.210	4.961	4.690	4.527	4.402	.350	.700	.250	.456
28	583601-1	X	132.33	126.01	119.13	114.99	111.81	8.89	17.78	6.35	11.58
	583601-2	Y	5.944	5.621	5.304	5.101	4.992	.437	.700	.250	.456
30	530092-1*	X	150.98	142.77	134.72	129.57	126.8	11.1	17.78	6.35	11.58
	530438-1	X	5.529	5.279	5.008	4.844	4.720	.350	.700	.250	.456
32	530438-2	Y	140.44	134.09	127.2	123.04	119.89	8.89	17.78	6.35	11.58
	530438-2	Y	6.365	5.928	5.292	5.132	5.072	.485	.760	.290	.455
			161.67	150.57	134.42	130.35	128.83	12.32	19.3	7.37	11.56

*Housing Material: Glass Filled Nylon

**Housing Material: Diallyl Phthalate

†Post Length .155 [3.94]

▲Post Length .250 [6.35]

Contacts

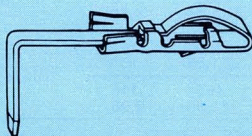

AMP-LEAF One-Piece Printed Circuit Edge Connectors

Dimensioning:

1. All dimensions in inches and millimetres. Values in brackets are metric equivalents.
2. Chart contains dimensions in inches over millimetres.

Keying Plug

(Keys on Contact Position)

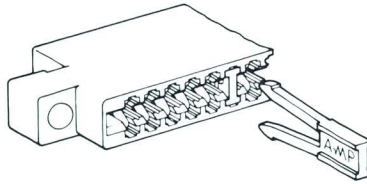

Part No. 480143-1 for .070-.055 [1.78-1.4] Board Thickness
Part No. 582756-1 for .104-.084 [2.64-2.13] Board Thickness

Inter-Contact Keying Plugs



Part No. 582501-1
Part No. 583274-1

Retaining Spring



(Material: Beryllium Copper)
Part No. 42973-1 Nickel Finish
Part No. 42973-2 Plain Finish
Part No. 42973-3 Gold Finish

Suggested Printed Circuit Board Layouts

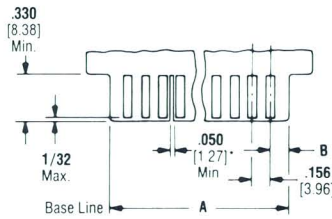

*Slot for Inter-Contact Keying may be located between any two pads (except the first two and last two pads) as desired.
8, 10, 12, 15, 18, 22, 25, 28, 32 and 36 Positions

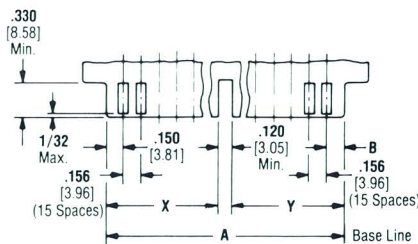

30 Position

X—(DP) 2.330 [59.18], (P) 2.326 [59.08]
 Y—(DP) 2.640 [67.06], (P) 2.636 [66.95]

No. of Pos.	Housing Material	Dimensions	
		A	B
8	(DP)	1.398 35.5	.153 3.89
	(P)	1.396 35.46	.152 3.86
10	(P)	1.709 43.4	.151 3.84
	(DP)	1.711 43.46	.152 3.86
12	(P)	2.018 51.26	.151 3.84
	(DP)	2.491 63.27	.153 3.89
15	(P)	2.487 63.17	.152 3.86
	(DP)	2.940 74.68	.144 3.66
18	(P)	2.935 74.55	.142 3.61
	(DP)	3.583 91	.153 3.89
22	(P)	3.578 90.88	.151 3.84
	(DP)	4.050 102.87	.153 3.89
25	(P)	4.043 102.69	.150 3.81
	(P)	4.512 114.6	.150 3.81
30	(DP)	5.093 129.36	.150 3.81
	(P)	5.085 129.16	.146 3.71
32	(DP)	5.125 130.18	.144 3.66
	(P)	5.117 129.97	.140 3.56

DP = Diallyl Phthalate

P = Phenolic

Board Thickness .070-.055 [1.78-1.4] all positions except 32 position — .104-.084 [2.64-2.13]

AMP-LEAF One-Piece Printed Circuit Edge Connectors

Dimensioning:

1. All dimensions in inches and millimetres. Values in brackets are metric equivalents.
2. Chart contains dimensions in inches over millimetres.

AMP-O-LECTRIC Automatic Terminating Machine

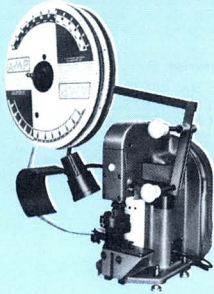

The AMP-O-LECTRIC Press is an all electric machine specifically designed for customer's in-plant production where an air supply is not readily available. This machine offers all of the receptacle staking capabilities of the "U" Press, including the ability to accommodate a range of board thicknesses from .062 to .125 [1.58 to 3.18].

Quick Change Miniature Applicator



These highly reliable quick-change applicators can be changed in minutes to facilitate post and receptacle style changeovers with no major interruptions in production. The fact that a change in post-size requires no adjustment and that only one simple adjustment is needed for the various board thicknesses further increases the speed and efficiency of the machines.

Extraction Tool



Tool No.	Used with Housings
465195-1	480110
	480142
	582140
	582147
	582264
	582358
	582500
	582535
	582536
	582627
	582825
	582963
	583167
	583183
	583273
	583279
	583280
	583722-1
	583723-1
	583724-1
	583680-1
	583725-1,-3
	583617-1,-3
	583726-1
	583685-1
	583742-1
	583552-1,-3
	583631-1
	583952-1
	583554-1
	583553-1
	583695-1
	583463-1
583950	
583637-1	
583399-1,-3	
583449-1	
583512-1	
583662-1	
583963	
583964-1	
465195-2	480133
	480146
	582191
	583731-1
	583360-1
	583428-1
583716-1	
583663-1	
465195-4	Any of the above when loaded with contact No. 66229 or 66293

Hand Crimping Tool (for Crimp Snap-In Contacts only)



Contact No. (Loose Piece)	Wire Range	Insul. Dia.	Hand Tool No.	Crimp Symbol
42839 60081	One 26	.050-.064 1.27-1.63	90028	26-22
	One 24			
	One 22			
42840 60082	One 22	.055-.080 1.4 -2.03	90017	22-20
	Two 24	.120 3.05 Max. Sum.	90028	21-18
	One 20		90017	22-20
	One 20	.055-.080 1.4-2.03	90028	21-18
	One 20		90101	20
	Two 22	.120 3.05 Max. Sum.	90017	1-18 2-22
	Two 22		90028	21-18
	One 18	.064-.080 1.63-2.03	90017	1-18 2-22
	One 18		90028	21-18
66028	Two 20	.160 4.07 Max. Sum.	90101	2-20
	Two 18		90031	2-18

Printed Circuit Connectors

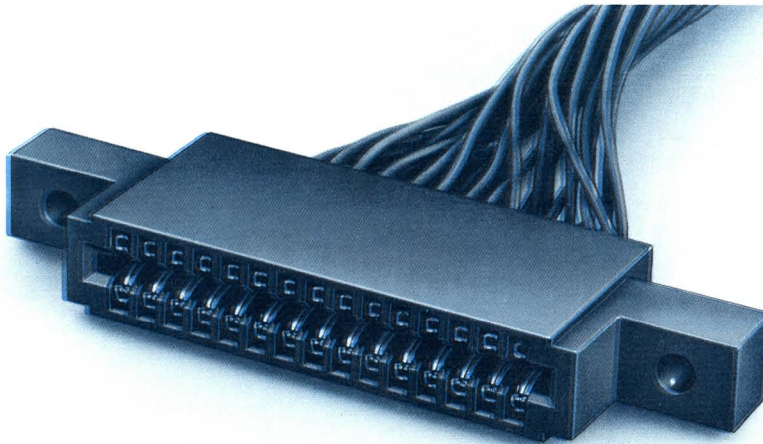

Designed especially for high density wire-to-board applications, these AMP twin leaf connectors feature crimp snap-in and solder eyelet contacts on .100 [2.54], .125 [3.18] or .156 [3.96] centers. With these connectors, customers buy only enough contacts to satisfy their circuit requirements. This cost savings benefit, coupled with high-speed automatic crimping of contacts plus the many quality features of both contact and housing, assures the highest level of reliability and performance . . . at an overall reduction in applied cost. For optimum versatility, connectors also can be supplied with preloaded posted contacts having .025 [0.64] square posts. These connectors are available with mounting ears in the .100 [2.54] and .125 [3.18] center-line spacing.

Contacts are bifurcated for contact redundancy and have dual, independent cantilever springs to provide excellent contact pressure and board retention without the need for high insertion forces — a significant advantage in applications requiring large numbers of high density connections. A unique folded box design also prevents overstressing of the spring members which can occur during handling or mating of printed circuit boards.

Contacts are available to accept a #28-16 AWG [0.08-1.4 mm²] wire range with insulation diameters up

to .080 [2.03]. They are fabricated from high conductivity phosphor bronze and can be supplied with various selective gold plating thicknesses. All contacts are furnished either loose piece for hand tool crimping or in reel-stored strips for application by high speed automated tooling. Also, loose piece contacts and hand tools are color coded by their accepted wire ranges to insure a proper contact-tool match. Once crimped, contacts are merely "snapped" into the housing by hand and can be easily removed with a simple extraction tool.

The one-piece housings are molded from glass-filled nylon material and afford the customer considerable design flexibility through a wide range of sizes—6 to 50 dual contact positions with a .100 [2.54] center-line spacing, 6 to 44 dual contact positions with a .125 [3.18] center-line spacing and 6 to 28 dual contact positions with .156 [3.96] centerline spacing. They can be supplied with or without mounting ears and, although primarily designed for 1/16 [1.59] thick double-sized boards are quickly adapted to single-sided board applications by use of retaining springs. Other housing features include: inter-contact and on-contact keying, molded cavity identification (front and rear), and a deep card travel slot for long wiping action to assure maximum electrical continuity and increased board-to-connector stabilization.

Twin Leaf Printed Circuit Edge Connectors

Features

- Crimp snap-in and solder eyelet contacts on .100 [2.54], .125 [3.18] or .156 [3.96] centers.
- User buys only enough contacts to meet circuit and retention requirements when using crimp snap-in or solder eyelet contacts.
- Preloaded .025 [0.64] square posted contacts on .100 [2.54] or .125 [3.18] centers.
- Contacts bifurcated for redundancy — dual cantilever springs assure excellent contact pressure.
- Low insertion forces.
- Selective gold over nickel plating on phosphor bronze base material.
- Accommodates #28-16 AWG [0.08-1.4 mm²] wire range; insulation diameters to .080 [2.03].
- Design flexibility: 6 to 50 dual positions with contacts on .100 [2.54] centers; 6 to 44 dual positions with contacts on .125 [3.18] centers; 6 to 28 dual positions with contacts on .156 [3.96] centers — with or without mounting ears.
- One-piece nylon housings accept 1/16 [1.59] thick double-sided cards; also adaptable to single-sided boards with retaining springs.
- Cavity identification (front and rear).
- Color coding assures proper contact-hand tool match.
- High-speed automatic machine terminations provide uniform reliability at lowest applied cost.
- Available on request —
Product Specification 108-9031
Crimping Specification 108-9215

All dimensions in inches and millimetres.
Values in brackets are metric equivalents.

Connector Housings (.100 [2.54] Centerline)

Housing Specifications

Dimensioning:
All dimensions in inches and millimeters.
Values in brackets are metric equivalents.

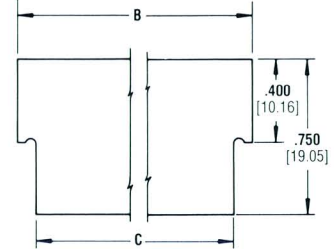
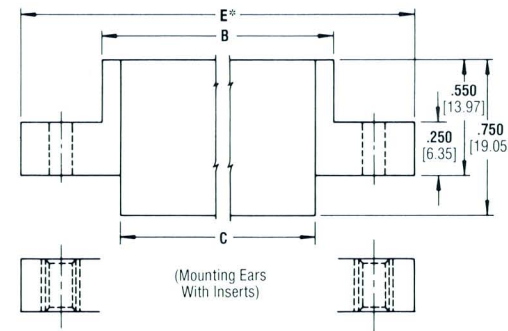
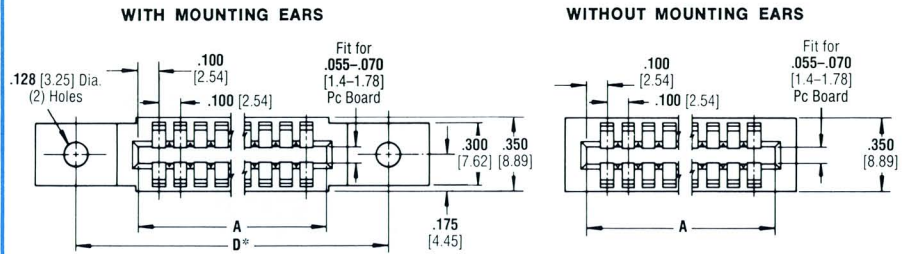

WITH PRELOADED POSTED CONTACTS

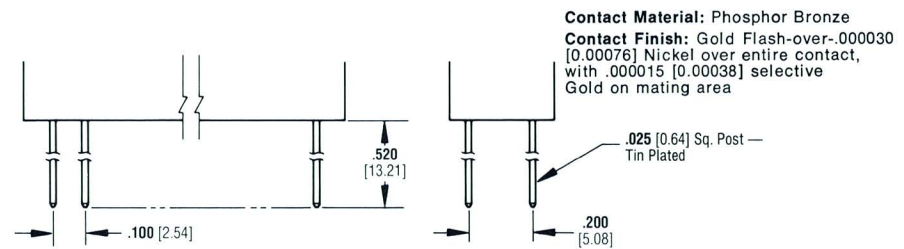

WITH PRELOADED RIGHT-ANGLE POST CONTACTS

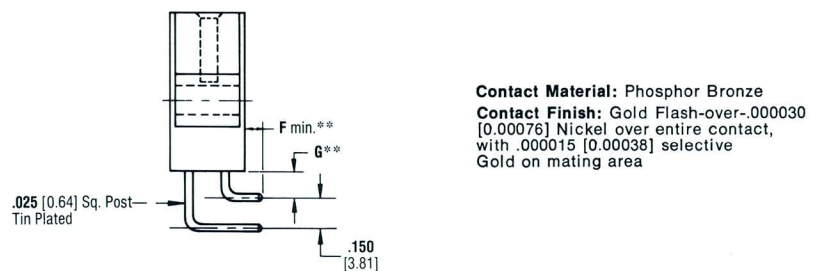

Specifications subject to change. Consult AMP Incorporated for latest design specifications.

Connector Housings (.100 [2.54] Centerline) Continued

Dimensioning:
 1. All dimensions in inches and millimetres. Values in brackets are metric equivalents.
 2. Chart contains dimensions in inches over millimetres.

Housing Material: Glass-Filled Nylon; Color, Brown
 Card Slot Depth — .345 [8.76]

No. of Dual Positions	Dimensions							Part Numbers				
	A	B	C	D*	E*	F**	G**	Without Mounting Ears	Mounting Ears	Mounting Ears With Inserts	Mounting Ears With Preloaded Posted Contacts	Mounting Ears With Preloaded Right-Angle Posted Contacts
6	.700	.900	.720	—	—	—	—	2-583717-1	—	—	—	—
	17.78	22.86	18.29	1.175	1.430	—	—	—	583861-5	—	583894-3	—
7	.800	1.000	.820	1.175	1.430	—	—	2-583717-3	—	—	—	—
	20.32	25.4	20.83	29.85	36.32	—	—	—	—	—	—	—
10	1.100	1.300	1.120	1.700	2.100	—	—	583717-1	583718-1	583890-1	—	—
	27.94	33.02	29.45	43.18	53.34	—	—	—	583861-7	—	583894-4	—
14	1.500	1.700	1.520	2.200	2.600	—	—	2-583717-7	—	—	—	—
	38.1	43.18	38.61	55.88	66.04	—	—	—	—	—	—	—
15	1.600	1.800	1.620	2.200	2.600	—	—	583717-3	583718-3	583890-3	583894-5	—
	40.64	45.72	41.15	55.88	66.04	—	—	—	583861-9	—	—	—
17	1.800	2.000	1.820	2.400	2.800	—	—	583717-5	583718-5	583890-5	—	—
	45.72	50.8	46.23	60.96	71.12	—	—	—	1-583861-1	—	583894-6	—
18	1.900	2.100	1.920	2.500	2.900	—	—	583717-7	583718-7	583890-7	—	—
	48.26	53.34	48.77	63.5	73.66	—	—	—	1-583861-3	—	583894-7	—
22	2.300	2.500	2.320	2.900	3.300	.090	.150	583717-9	583718-9	583890-9	—	583900-2
	58.42	63.5	58.93	73.66	83.82	2.28	3.81	—	1-583861-5	—	583894-8	—
25	2.600	2.800	2.620	3.200	3.600	.090	.150	1-583717-1	1-583718-1	1-583890-1	—	583900-1
	66.04	71.12	66.55	81.28	91.44	2.28	3.81	—	1-583861-7	—	583894-9	—
28	2.900	3.100	2.920	3.500	3.900	—	—	2-583717-5	1-583718-9	1-583890-9	—	—
	73.66	78.74	74.17	88.9	99.06	—	—	—	1-583861-9	—	1-583894-0	—
30	3.100	3.300	3.120	3.700	4.100	.090	.150	1-583717-3	1-583718-3	1-583890-3	—	583900-4
	78.74	83.82	79.25	93.98	104.14	2.28	3.81	—	583861-1	—	583894-1	—
40	4.100	4.300	4.120	4.700	5.100	—	—	1-583717-5	1-583718-5	1-583890-5	—	—
	104.14	109.22	104.65	119.38	129.54	—	—	—	583861-5	—	583894-2	—
50	5.100	5.300	5.120	5.700	6.100	.250	1.050	1-583717-7	1-583718-7	1-583890-7	—	583900-3
	129.54	134.62	130.05	144.78	154.94	6.35	26.67	—	2-583861-1	—	1-583894-1	—

*For housings with mounting ears only.
 **For housings preloaded with right-angle post contacts only.

- Notes:**
- These housings will accept only crimp snap-in contacts for wire ranges #28-24 AWG [0.08-0.2 mm²] or #24-20 AWG [0.2-0.6 mm²] as well as the solder eyelet version. Refer to page 13-64 for specific contact part nos.
 - Other connector sizes within the 6-to-50 dual position range are available upon request.

Housing Specifications (Continued)

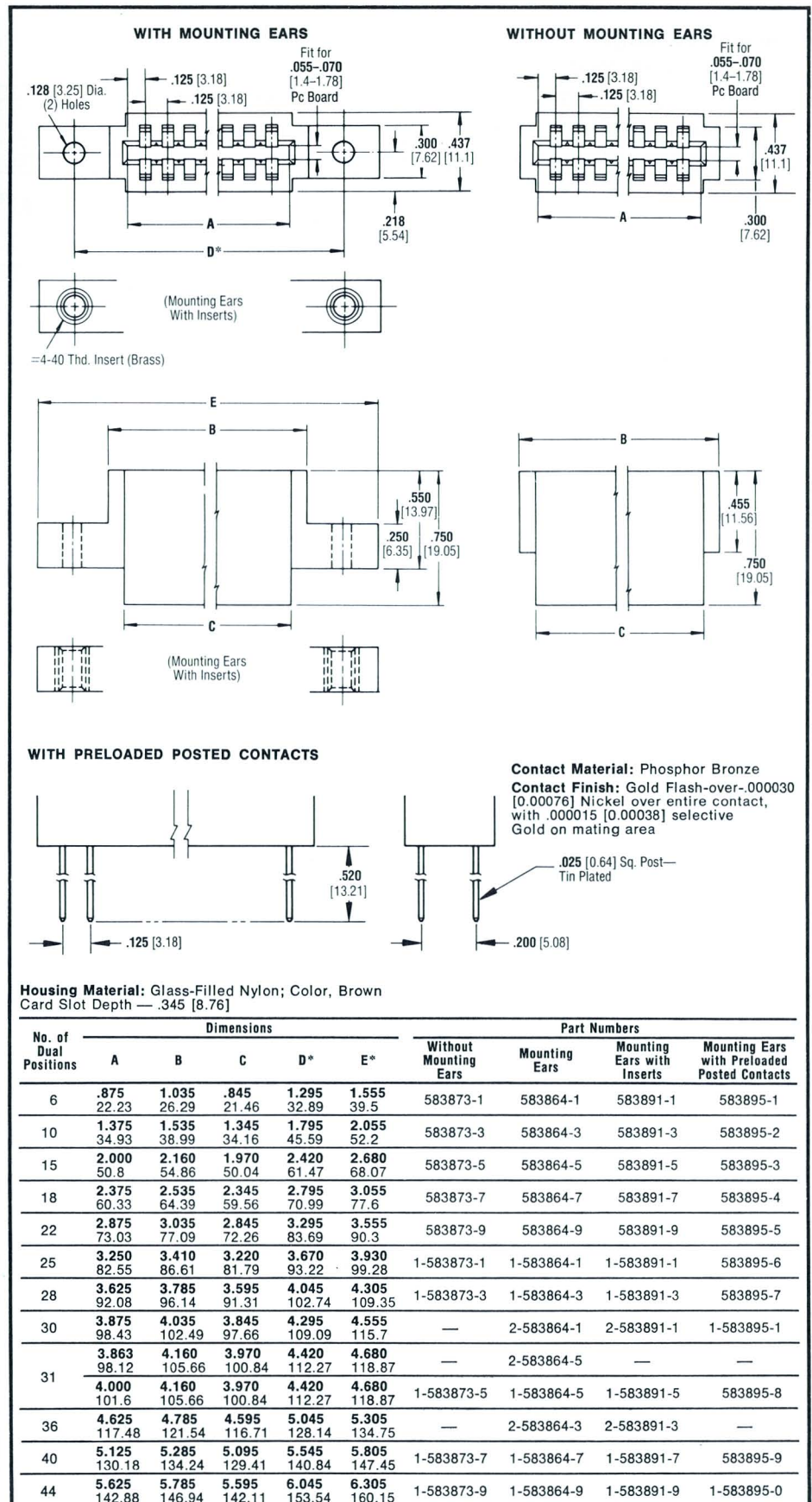

Housing Material: Glass-Filled Nylon; Color, Brown
Card Slot Depth — .345 [8.76]

No. of Dual Positions	Dimensions					Part Numbers			
	A	B	C	D*	E*	Without Mounting Ears	Mounting Ears	Mounting Ears with Inserts	Mounting Ears with Preloaded Posted Contacts
6	.875	1.035	.845	1.295	1.555	583873-1	583864-1	583891-1	583895-1
	22.23	26.29	21.46	32.89	39.5				
10	1.375	1.535	1.345	1.795	2.055	583873-3	583864-3	583891-3	583895-2
	34.93	38.99	34.16	45.59	52.2				
15	2.000	2.160	1.970	2.420	2.680	583873-5	583864-5	583891-5	583895-3
	50.8	54.86	50.04	61.47	68.07				
18	2.375	2.535	2.345	2.795	3.055	583873-7	583864-7	583891-7	583895-4
	60.33	64.39	59.56	70.99	77.6				
22	2.875	3.035	2.845	3.295	3.555	583873-9	583864-9	583891-9	583895-5
	73.03	77.09	72.26	83.69	90.3				
25	3.250	3.410	3.220	3.670	3.930	1-583873-1	1-583864-1	1-583891-1	583895-6
	82.55	86.61	81.79	93.22	99.28				
28	3.625	3.785	3.595	4.045	4.305	1-583873-3	1-583864-3	1-583891-3	583895-7
	92.08	96.14	91.31	102.74	109.35				
30	3.875	4.035	3.845	4.295	4.555	—	2-583864-1	2-583891-1	1-583895-1
	98.43	102.49	97.66	109.09	115.7				
31	3.863	4.160	3.970	4.420	4.680	—	2-583864-5	—	—
	98.12	105.66	100.84	112.27	118.87				
36	4.000	4.160	3.970	4.420	4.680	1-583873-5	1-583864-5	1-583891-5	583895-8
	101.6	105.66	100.84	112.27	118.87				
40	4.625	4.785	4.595	5.045	5.305	—	2-583864-3	2-583891-3	—
	117.48	121.54	116.71	128.14	134.75				
44	5.125	5.285	5.095	5.545	5.805	1-583873-7	1-583864-7	1-583891-7	583895-9
	130.18	134.24	129.41	140.84	147.45				
44	5.625	5.785	5.595	6.045	6.305	1-583873-9	1-583864-9	1-583891-9	1-583895-0
	142.88	146.94	142.11	153.54	160.15				

*For housings with mounting ears only.

- Notes:**
- These housings will accept all crimp snap-in contacts as well as the solder eyelet version. Refer to page 13-64 for specific contact part nos.
 - Other connector sizes within the 6-to-44 dual position range are available upon request.

Dimensioning:

1. All dimensions in inches and millimetres. Values in brackets are metric equivalents.
2. Chart contains dimensions in inches over millimetres.

**Connector Housings
(.156 [3.96] Centerline)**

WITH MOUNTING EARS

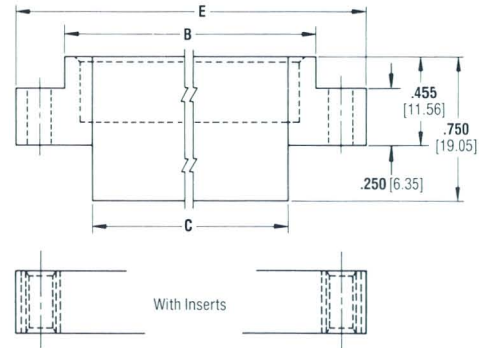
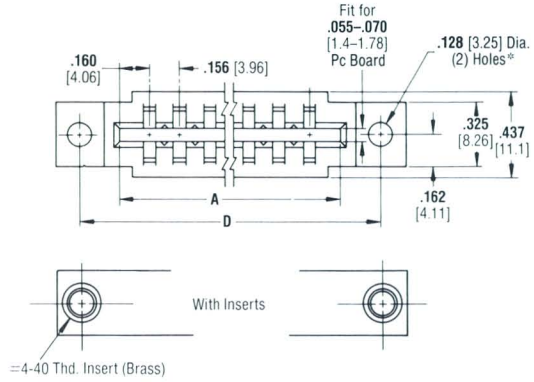

Housing Material: Glass-Filled Nylon; Color, Brown
Card Slot Depth — .345 [8.76]

No. of Dual Positions	Dimensions					Part Numbers	
	A	B	C	D	E	Mounting Ears	Mounting Ears With Inserts
6	1.100 27.94	1.264 32.11	.976 24.79	1.535 38.99	1.785 45.34	1-583859-3	583888-1
8	1.412 35.86	1.576 40.03	1.288 32.72	1.847 46.91	2.097 53.26	2-583859-1	—
10	1.742 44.25	1.888 47.96	1.600 40.64	2.159 54.84	2.409 61.19	583859-9	583888-3
12	2.036 51.71	2.200 55.88	1.912 48.56	2.471 62.76	2.721 69.11	1-583859-5	—
15	2.504 63.6	2.668 67.77	2.380 60.45	2.939 74.65	3.189 81	583859-7	—
18	2.972 75.49	3.136 79.65	2.848 72.34	3.407 86.54	3.657 92.89	583859-5 1-583859-1*	583888-5
22	3.596 91.34	3.760 95.5	3.472 81.19	4.031 102.39	4.281 108.74	583859-3	583888-9
24	3.908 99.26	4.072 103.43	3.784 96.11	4.343 110.31	4.593 116.66	1-583859-9	—
28	4.532 115.11	4.696 119.28	4.408 111.96	4.967 126.16	5.217 132.51	583859-1	583888-7
36	5.780 146.81	5.944 150.98	5.656 143.66	6.215 157.86	6.465 164.21	2-583859-3	—

*Mounting ear hole .156 [3.96] diameter for part no. 1-583859-1.

Notes:

1. These housings will accept all crimp snap-in contacts as well as the solder eyelet version. Refer to page 13-64 for specific contact part nos.
2. Other connector sizes within the 6-36 dual position range are available upon request.

Contact Specifications

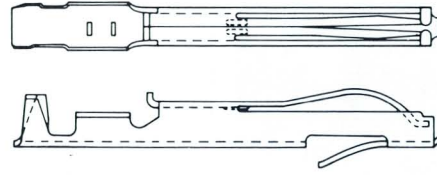

CRIMP TYPE

Material: Phosphor Bronze
Finish: See "finish code" and explanations listed below.

Connector Centerline	Wire Size Range		Ins. Dia. Range	Finish Code	Contact Part No.			Color Code*	Hand Tool Part No.
	AWG	mm ²			Strip Form (for Mini-Applicator)	Strip Form (for Stripper/Crimper)	Loose Piece		
.100, 2.54, .125, 3.18, .156, 3.96	28-24	0.08-0.2	.035-.055 .89-1.4	A	583616-2	583616-6	583616-4	Orange	90268-1
				B	583616-3	583616-7	583616-5		
				C	583616-8	1-583616-3	583616-9		
				E	1-583616-0	1-583616-2	1-583616-1		
.156, 3.96	24-20	0.2-0.6	.048-.060 1.22-1.52	B	583853-2	583853-7	583853-4	Green	90272-1
				A	583853-3	583853-6	583853-5		
				C	583853-8	—	583853-9		
				E	1-583853-0	1-583853-2	1-583853-1		
.125, 3.18, .156, 3.96	22-18	0.3-0.9	.049-.080 1.24-2.03	A	583649-2	583649-9	583649-5	Violet	90264-1
				A	583649-3	583649-8	583649-6		
				C	583649-4	1-584649-0	583649-7		
.156, 3.96	20-16	0.5-1.4	.049-.080 1.24-2.03	C	583875-2	583875-4	583875-3	White	90285-1

*A colored dot is stamped on each loose piece contact signifying its accepted wire range. The crimping nest of the applicable hand tool is also coded correspondingly.

Contact Extraction Tool No. 91073-1

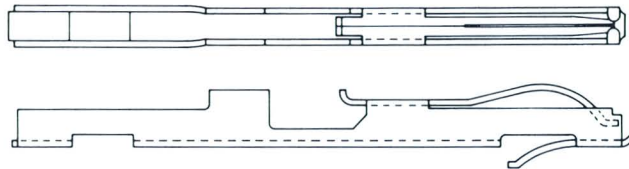

SOLDER EYELET TYPE

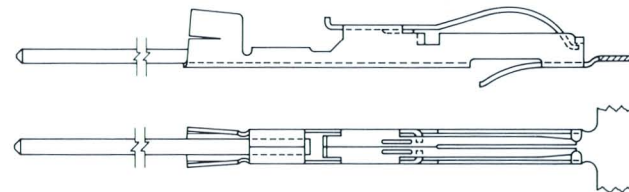

POSTED TYPE

Material: Phosphor Bronze
Finish: See "finish code" and explanations listed below.

Contact Style	Connector Centerline	Finish Code	Loose Piece Contact Part No.
Solder Eyelet	.100, .125, 2.54, 3.18	D	583854-3
		E	583854-5
	.156, 3.96	D	583885-3
		E	583885-5
Posted	.100, 2.54	E*	583879-4
		E*	583884-1
	.125, 3.18	E*	583884-1

*Post is tin plated phosphor bronze.
Contact Extraction Tool No. 91073-1

- Finish Code:** A—.000030 [0.00076] Nickel over entire contact with .000030 [0.00076] selective Gold on mating area.
 B—.000030 [0.00076] Nickel over entire contact with .000015 [0.00038] selective Gold on mating area.
 C—Gold Flash-over-.000050 [0.00127] Nickel over entire contact with .000050 [0.00127] selective Gold on mating area.
 D—Gold Flash-over-.000030 [0.00076] Nickel over entire contact with .000030 [0.00076] selective Gold on mating area.
 E—Gold Flash-over-.000030 [0.00076] Nickel over entire contact with .000015 [0.00038] selective Gold on mating area.

Note: Only loose piece contacts manufactured and supplied by AMP are to be used with the hand tools listed above. No attempt should be made to produce loose piece parts from a strip since special cutoff tooling is required to assure a properly functioning part.

Accessories

Dummy Contact

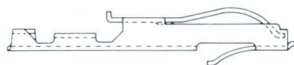

Material: Phosphor Bronze
Part Numbers:
583857-5 (Tin plated)
583857-6 (.000030 [0.00076] Nickel plated)
583857-7 (Gold Flash-over-Nickel plated)
583857-8 (unplated)

The dummy contact is to be used in sparsely loaded housings to balance contact pressure. For specific recommendations, consult AMP engineering.

Retaining Spring



Material: Beryllium Copper
Part Numbers:
583691-2 (unplated)
583691-3 (Gold Flash-over-Nickel plated)

Retaining springs are used for single-sided pc board applications. Use 1 (one) spring per 6 empty cavities.

Keying Plugs

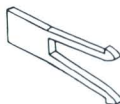

ON-CONTACT
PART NO. 583764-1



INTER-CONTACT
PART NO. 583274-1

Material: Nylon; Color, Natural

Locking Key



Material: Nylon
Part No. 530213-1

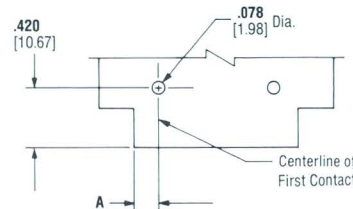
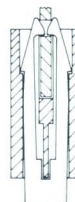

PC BOARD HOLE LAYOUT

A Dimension		Connector Centerline	
Inch	mm	Inch	mm
.100	2.54	.100	2.54
.125	3.18	.125	3.18
.160	4.06	.156	3.96

Application Tooling



Side-Feed Miniature Applicators can be changed in a matter of minutes to afford maximum flexibility and minimum production downtime for a variety of AMP machines.

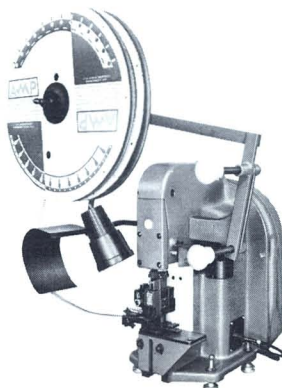

The **AMP-O-LECTRIC Terminating Machine** is electrically powered and offers up to 4000 finished attachments per hour. It installs a variety of AMP products on a wide range of wire sizes.

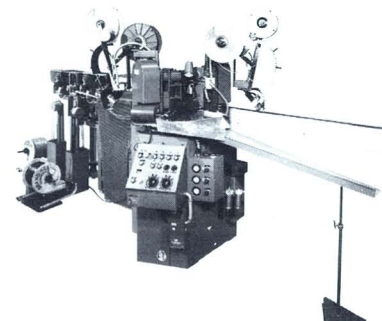

The **AMPOMATOR Machine** is electrically operated and automatically feeds the wire, strips one or both ends and attaches terminals in one machine cycle. Speeds, depending upon lead length (from 3 [76.2 mm] to 90 [2 286 mm]), can be up to 5700 leads or 22,800 finished terminations per hour.

Printed Circuit Connectors

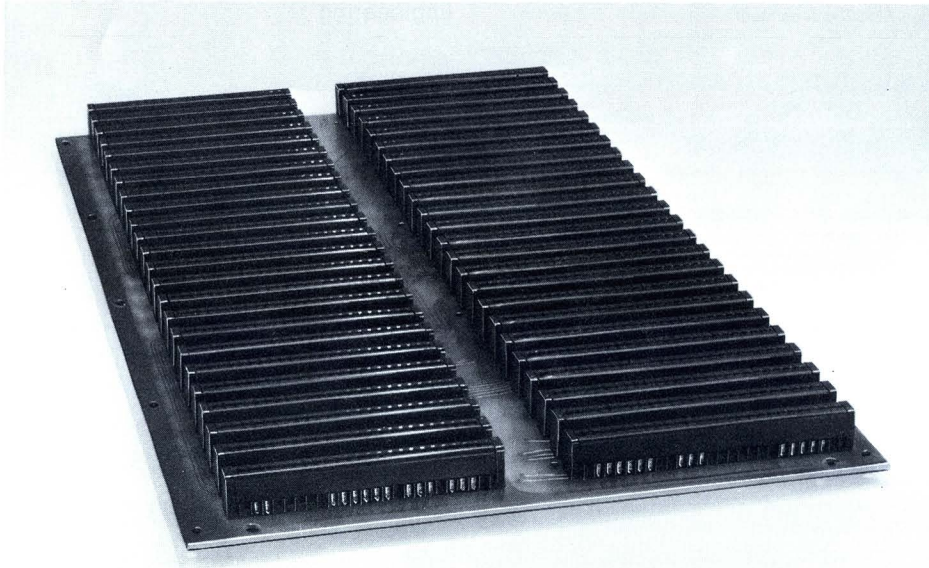

**Twin Leaf Mother Board
Printed Circuit
Connectors
(Solder Type)**

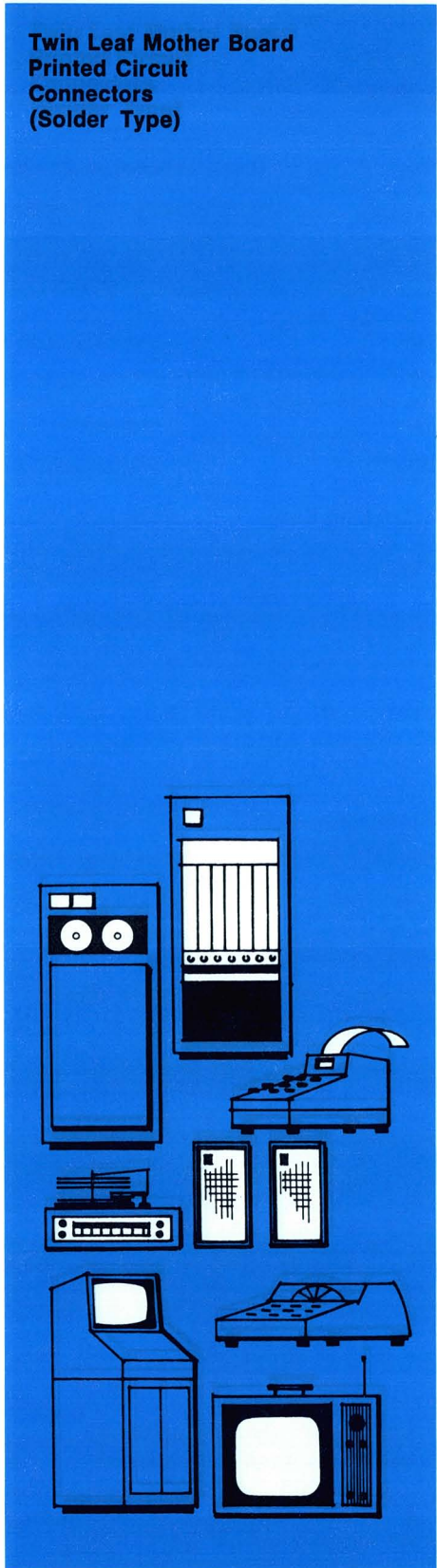
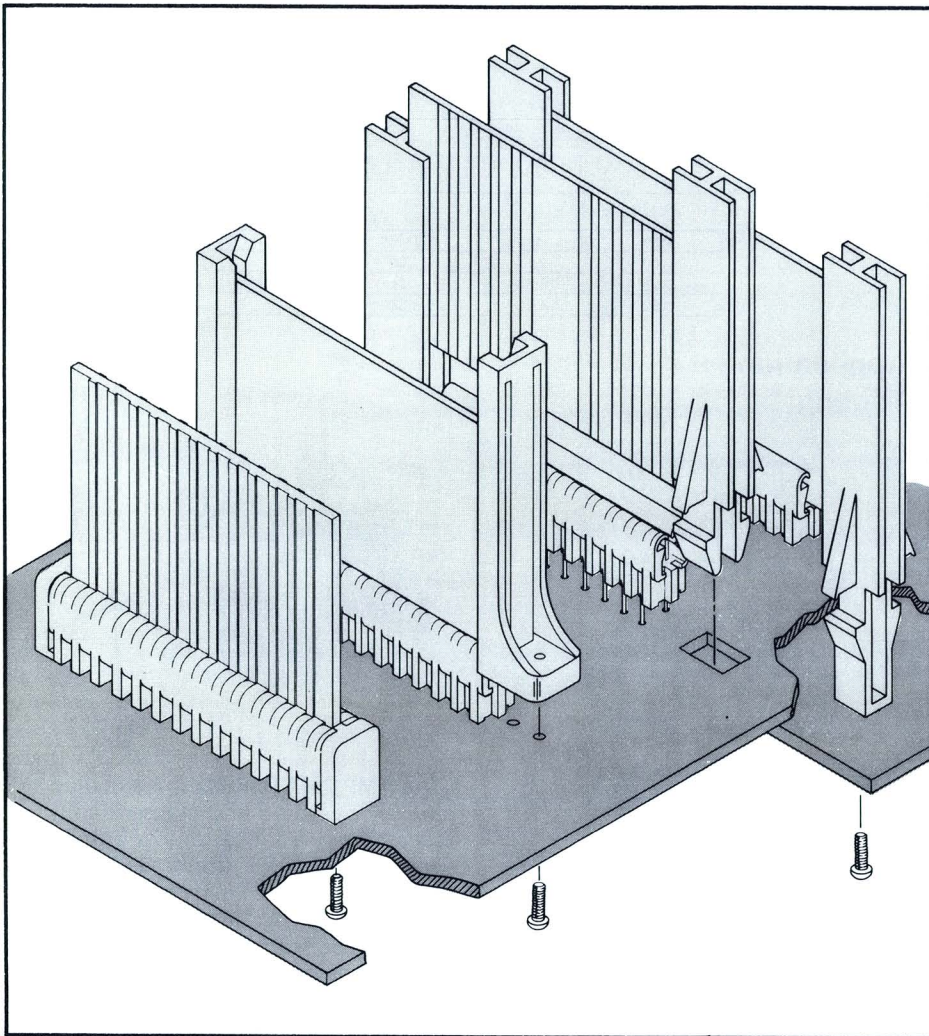

Dimensioning:

All dimensions in inches and millimetres.
Values in brackets are metric equivalents.

General Information

Features

- Wide variety of sizes available from 3 dual positions and up — no initial tooling investment required for new versions.
- Connectors can be selectively loaded to custom contact patterns.
- Connectors tooled on all industry standard centerlines — .100" [2.54], .125" [3.18], .150" [3.81], .156" [3.96] and .200" [5.08].
- Closed card entry design for daughter board pad and contact protection.
- Adaptable to wide range of mother board thicknesses up to .104" [2.64] maximum.
- Phosphor bronze contacts selectively plated for top performance and maximum economy.
- Contact available with .031" [0.79] sq. posts to accept wrap-type terminations.
- Protective channel provides built-in anti-overstress for contacts.
- Daughter card keying available for inter-contact or on-contact.

Note: .200" [5.08] centerline capability is provided by selectively loading .100" [2.54] centerline housing every other dual contact position.

Product Specification
108-9027

- I. S. Numbers
- 7479 — Keying Plugs
 - 7498 — Connector Layout
 - 7506 — Card Guides

Specifications subject to change.
Consult AMP Incorporated for latest design specifications.

With the use of solid state design continuing to grow in the Commercial Electronics Industry, the need for a low cost, highly reliable mother-daughter board type connector has been created. The AMP-UNYT Twin Leaf Connector is designed to meet these requirements by offering a one-piece, multi-contact connector that requires no front end tooling.

Designed exclusively for double-sided printed circuit boards, this versatile connector provides the lowest applied cost by combining the use of preloaded contacts and selective plating in critical contact areas. Contoured surfaces of the contacts are gold-over-nickel plated to provide positive electrical contact between contacts and daughter board pads. Contact posts are tin plated and provide excellent solderability for dip soldering contacts to .104" [2.64] max. thick mother boards. And for added versatility, contacts are available with an .031" [0.79] sq. post which accepts a wrap-type termination for board-to-wire applications.

Maximum reliability of the twin leaf connector is assured through superior contact tolerance of environmental stresses including shock, vibration, temperature and humidity variations. Other parameters such as insulation resistance, termination resistance, durability and contact separation force meet all of industry's requirements for reliability.

Connector housings are available from 3 to 50 dual-contact positions and up — with contacts on .100" [2.54], .125" [3.18], .150" [3.81], .156" [3.96] or .200" [5.08] centers. Made of glass filled nylon with U.L. 94V-0 rating, these housings offer design features which include a standoff that facilitates the use of a probe for electrical continuity checks without risking damage to the contacts and a closed card entry design for daughter board pad and contact protection. Housings accept .055" [1.4] to .070" [1.78] thick daughter boards and may be polarized by the inter-contact or on-contact method of keying.

Alignment of daughter board pads with the Twin Leaf Contacts is quickly and easily accomplished by the use of card guides or end caps.

PRODUCT SPECIFICATIONS

Current Rating:
3 amps continuous current

Temperature Rating:
-55°C to +105°C

Insulation Resistance:
5,000 Megohms

Dielectric Withstanding:

Altitude		Test Voltage (AC, RMS)	
Feet	Metres	Contact Centerline Spacing	
		.100 [2.54]	.150 [3.81]
Sea Level	—	1,000	1,500
50,000	15 240	400	600
70,000	21 336	280	400

Termination Resistance:
10 Milliohms

Durability:
100 Cycles (engage — withdraw) with .000015 [0.00038] select gold plating on contact area

Contact Plating:
.000015 [0.00038] selective gold on contact area — bright tin on solder tine

Contact

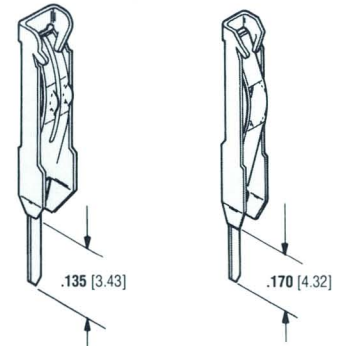

Contact for
.150" [3.81] and
.156" [3.96]
Centerline Spacing

Contact for
.100" [2.54] and
.125" [3.18]
Centerline Spacing

Connector Assemblies With End Caps .010 x .024 [0.25 x 0.61] Solder Posts

Contact Material and Finish:
 Phosphor bronze — .000015 [0.00038]
 Selective Gold over .000030 [0.00076] Nickel,
 Solder Tine — Tin plated.

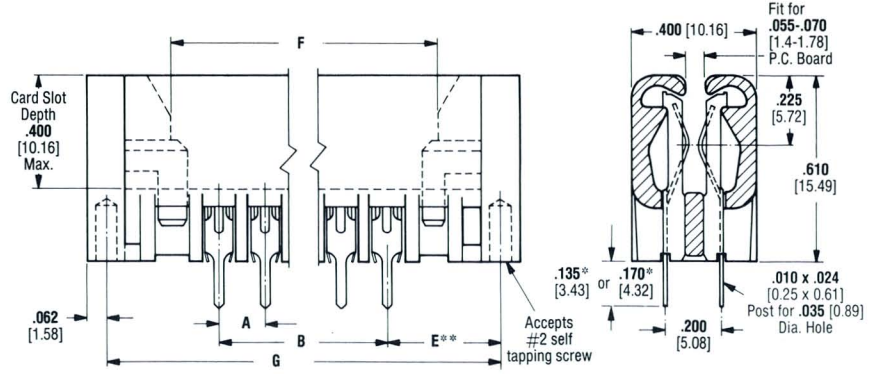

*.135 [3.43] for .150 [3.81] or .156 [3.96] Centerline Spacing; .170 [4.32] for .100 [2.54] or .125 [3.18] Centerline Spacing.
 **See mounting details, page 13-74.

No. of Dual Pos.	A=.100 [2.54] Centerline Spacing				A=.125 [3.18] Centerline Spacing				A=.150 [3.81] Centerline Spacing				A=.156 [3.96] Centerline Spacing			
	Part No.	B	F	G	Part No.	B	F	G	Part No.	B	F	G	Part No.	B	F	G
3	583715-1	.200 5.08	.400 10.16	.734 18.64	583679-2	.250 6.35	.500 12.7	.884 22.45	583692-2	.300 7.62	.600 15.24	1.034 26.26	583660-3	.312 7.92	.624 15.85	1.070 27.18
4	583715-2	.300 7.62	.500 12.7	.834 21.18	583679-3	.375 9.53	.625 15.88	1.009 25.63	583692-3	.450 11.43	.750 19.05	1.184 30.07	583660-4	.468 11.89	.780 19.81	1.226 31.14
5	583715-3	.400 10.16	.600 15.24	.934 23.72	583679-4	.500 12.7	.750 19.05	1.134 28.8	583692-4	.600 15.24	.900 22.86	1.334 33.88	583660-5	.624 15.85	.936 23.77	1.382 35.1
6	583715-4	.500 12.7	.700 17.78	1.034 26.26	583679-5	.625 15.88	.875 22.23	1.259 31.98	583692-5	.750 19.05	1.050 26.67	1.484 37.69	583660-6	.780 19.81	1.092 27.74	1.538 39.07
7	583715-5	.600 15.24	.800 20.32	1.134 28.8	583679-6	.750 19.05	1.000 25.4	1.384 35.15	583692-6	.900 22.86	1.200 30.48	1.634 41.5	583660-7	.936 23.77	1.248 31.7	1.694 43.03
8	583715-6	.700 17.78	.900 22.86	1.234 31.34	583679-7	.875 22.23	1.125 28.58	1.509 38.33	583692-7	1.050 26.67	1.350 34.29	1.784 45.31	583660-8	1.092 27.74	1.404 35.66	1.850 46.99
9	583715-7	.800 20.32	1.000 25.4	1.334 33.88	583679-8	1.000 25.4	1.250 31.75	1.634 41.5	583692-8	1.200 30.48	1.500 38.1	1.934 49.12	583660-9	1.248 31.7	1.560 39.62	2.006 50.95
10	583715-8	.900 22.86	1.100 27.94	1.434 36.42	583679-9	1.125 28.58	1.375 34.93	1.759 44.68	583692-9	1.350 34.29	1.650 41.91	2.084 52.93	1-583660-0	1.404 35.66	1.716 43.59	2.162 54.91
11	583715-9	1.000 25.4	1.200 30.48	1.534 38.96	1-583679-0	1.250 31.75	1.500 38.1	1.884 47.85	1-583692-0	1.500 38.1	1.800 45.72	2.234 56.74	1-583660-1	1.560 39.62	1.872 47.55	2.318 58.88
12	1-583715-0	1.100 27.94	1.300 33.02	1.634 41.5	1-583679-1	1.375 34.93	1.625 41.28	2.009 51.03	1-583692-1	1.650 41.91	1.950 49.53	2.384 60.55	1-583660-2	1.716 43.59	2.028 51.51	2.474 62.84
13	1-583715-1	1.200 30.48	1.400 35.56	1.734 44.04	1-583679-2	1.500 38.1	1.750 44.45	2.134 54.2	1-583692-2	1.800 45.72	2.100 53.34	2.534 64.36	1-583660-3	1.872 47.55	2.184 55.47	2.630 66.8
14	1-583715-2	1.300 33.02	1.500 38.1	1.834 46.58	1-583679-3	1.625 41.28	1.875 47.63	2.259 57.38	1-583692-3	1.950 49.53	2.250 57.15	2.684 68.17	1-583660-4	2.028 51.51	2.340 59.44	2.786 70.76
15	1-583715-3	1.400 35.56	1.600 40.64	1.934 49.12	1-583679-4	1.750 44.45	2.000 50.8	2.384 60.55	1-583692-4	2.100 53.34	2.400 60.96	2.834 71.98	583660-2	2.184 55.47	2.496 63.4	2.942 74.73
16	1-583715-4	1.500 38.1	1.700 43.18	2.034 51.66	1-583679-5	1.875 47.63	2.125 53.98	2.509 63.73	1-583692-5	2.250 57.15	2.550 64.77	2.984 75.79	1-583660-5	2.340 59.44	2.652 67.36	3.098 78.7
17	1-583715-5	1.600 40.64	1.800 45.72	2.134 54.2	1-583679-6	2.000 50.8	2.250 57.15	2.634 66.9	1-583692-6	2.400 60.96	2.700 68.58	3.134 79.6	1-583660-6	2.496 63.4	2.808 71.32	3.254 82.65
18	1-583715-6	1.700 43.18	1.900 48.26	2.234 56.74	1-583679-7	2.125 53.98	2.375 60.33	2.759 70.08	1-583692-7	2.550 64.77	2.850 72.39	3.284 83.41	1-583660-7	2.652 67.36	2.964 75.29	3.410 86.61
19	1-583715-7	1.800 45.72	2.000 50.8	2.334 59.28	1-583679-8	2.250 57.15	2.500 63.5	2.884 73.25	1-583692-8	2.700 68.58	3.000 76.2	3.434 87.22	1-583660-8	2.808 71.32	3.120 79.25	3.566 90.58
20	1-583715-8	1.900 48.26	2.100 53.34	2.434 61.82	1-583679-9	2.375 60.33	2.625 66.68	3.009 76.43	1-583692-9	2.850 72.39	3.150 80.01	3.584 91.03	1-583660-9	2.964 75.29	3.276 83.21	3.722 94.54
21	1-583715-9	2.000 50.8	2.200 55.88	2.534 64.36	2-583679-0	2.500 63.5	2.750 69.85	3.134 79.6	2-583692-0	3.000 76.2	3.300 83.82	3.734 94.84	2-583660-0	3.120 79.25	3.432 87.17	3.878 98.5
22	2-583715-0	2.100 53.34	2.300 58.42	2.634 66.9	2-583679-1	2.625 66.68	2.875 73.03	3.259 82.78	2-583692-1	3.150 80.01	3.450 87.63	3.884 98.65	2-583660-1	3.276 83.21	3.588 91.14	4.034 102.46
23	2-583715-1	2.200 55.88	2.400 60.96	2.734 69.44	2-583679-2	2.750 69.85	3.000 76.2	3.384 85.95	2-583692-2	3.300 83.82	3.600 91.44	4.034 102.46	2-583660-2	3.432 87.17	3.744 95.1	4.190 106.43
24	2-583715-2	2.300 58.42	2.500 63.5	2.834 71.98	2-583679-3	2.875 73.03	3.125 79.38	3.509 89.13	2-583692-3	3.450 87.63	3.750 95.25	4.184 106.27	2-583660-3	3.588 91.14	3.900 99.06	4.346 110.39
25	2-583715-3	2.400 60.96	2.600 66.04	2.934 74.52	2-583679-4	3.000 76.2	3.250 82.55	3.634 92.3	2-583692-4	3.600 91.44	3.900 99.06	4.334 110.08	2-583660-4	3.744 95.1	4.056 103.02	4.502 114.35
26	2-583715-4	2.500 63.5	2.700 68.78	3.034 77.06	583679-1	3.125 79.38	3.375 85.73	3.759 95.48	2-583692-5	3.750 95.25	4.050 102.87	4.484 113.89	2-583660-5	3.900 99.06	4.212 106.98	4.658 118.31

Note: Sizes over 50 dual positions and custom contact patterns are available upon request. Also a card extender version of all connectors for test purposes is available. Consult AMP Incorporated for part numbers of these items.

Dimensioning:

- All dimensions in inches and millimetres. Values in brackets are metric equivalents.
- Chart contains dimensions in inches over millimetres.

Connector Assemblies With End Caps .010 x .024 [0.25 x 0.61] Solder Posts (Continued)

Contact Material and Finish:
Phosphor bronze — .000015 [0.00038]
Selective Gold over .000030 [0.00076] Nickel,
Solder Tine — Tin plated.

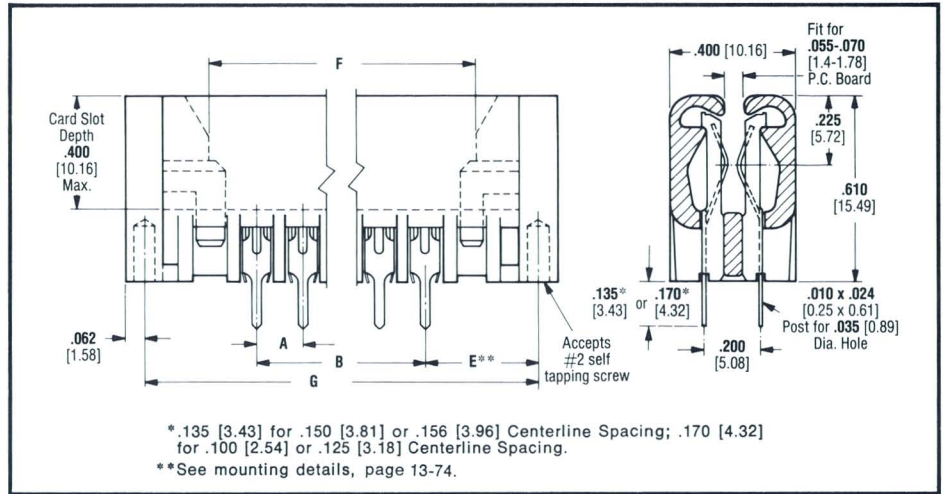

No. of Dual Pos.	A = .100 [2.54] Centerline Spacing				A = .125 [3.18] Centerline Spacing				A = .150 [3.81] Centerline Spacing				A = .156 [3.96] Centerline Spacing			
	Part No.	B	F	G	Part No.	B	F	G	Part No.	B	F	G	Part No.	B	F	G
27	2-583715-5	2.600 66.04	2.800 71.12	3.134 79.6	2-583679-5	3.250 82.55	3.500 88.9	3.884 98.65	2-583692-6	3.900 99.06	4.200 106.68	4.634 117.7	2-583660-6	4.056 103.02	4.368 110.95	4.814 122.28
28	2-583715-6	2.700 68.58	2.900 73.66	3.234 82.14	2-583679-6	3.375 85.73	3.625 92.08	4.009 101.83	2-583692-7	4.050 102.87	4.350 110.49	4.784 121.51	2-583660-7	4.212 106.98	4.524 114.91	4.970 126.24
29	2-583715-7	2.800 71.12	3.000 76.2	3.334 84.68	2-583679-7	3.500 88.9	3.750 95.25	4.134 105	2-583692-8	4.200 106.68	4.500 114.3	4.934 125.32	2-583660-8	4.368 110.95	4.680 118.87	5.126 130.2
30	2-583715-8	2.900 73.66	3.100 78.74	3.434 87.22	2-583679-8	3.625 92.08	3.875 98.43	4.259 108.18	583692-1	4.350 110.49	4.650 118.11	5.084 129.13	2-583660-9	4.524 114.91	4.836 122.83	5.282 134.16
31	2-583715-9	3.000 76.2	3.200 81.28	3.534 89.76	2-583679-9	3.750 95.25	4.000 101.6	4.384 111.35	2-583692-9	4.500 114.3	4.800 121.92	5.234 132.94	3-583660-0	4.680 118.87	4.992 126.8	5.438 138.12
32	3-583715-0	3.100 78.74	3.300 83.82	3.634 92.3	3-583679-0	3.875 98.43	4.125 104.78	4.509 114.53	3-583692-0	4.650 118.11	4.950 125.73	5.384 136.75	3-583660-1	4.836 122.83	5.148 130.76	5.594 142.09
33	3-583715-1	3.200 81.28	3.400 86.36	3.734 94.84	3-583679-1	4.000 101.6	4.250 107.95	4.634 117.7	3-583692-1	4.800 121.92	5.100 129.54	5.534 140.56	3-583660-2	4.992 126.8	5.304 134.72	5.750 146.05
34	3-583715-2	3.300 83.82	3.500 88.9	3.834 97.38	3-583679-2	4.125 104.78	4.375 111.13	4.759 120.88	3-583692-2	4.950 125.73	5.250 133.35	5.684 144.37	3-583660-3	5.148 130.76	5.460 138.68	5.906 150.01
35	3-583715-3	3.400 86.36	3.600 91.44	3.934 99.92	3-583679-3	4.250 107.95	4.500 114.3	4.884 124.05	3-583692-3	5.100 129.54	5.400 137.16	5.834 148.18	3-583660-4	5.304 134.72	5.616 142.65	6.062 153.97
36	3-583715-4	3.500 88.9	3.700 93.98	4.034 102.46	3-583679-4	4.375 111.13	4.625 117.48	5.009 127.23	3-583692-4	5.250 133.35	5.550 140.97	5.984 151.99	583660-1	5.460 138.64	5.772 146.61	6.218 157.94
37	3-583715-5	3.600 91.44	3.800 96.52	4.134 105	3-583679-5	4.500 114.3	4.750 120.65	5.134 130.4	3-583692-5	5.400 137.16	5.700 144.78	6.134 155.8	3-583660-5	5.616 142.65	5.928 150.57	6.374 161.9
38	3-583715-6	3.700 93.98	3.900 99.06	4.234 107.54	3-583679-6	4.625 117.48	4.875 123.83	5.259 133.58	3-583692-6	5.550 140.97	5.850 148.59	6.284 159.61	3-583660-6	5.772 146.61	6.084 154.53	6.530 165.86
39	3-583715-7	3.800 96.52	4.000 101.6	4.334 110.08	3-583679-7	4.750 120.65	5.000 127	5.384 136.75	3-583692-7	5.700 144.78	6.000 152.4	6.434 163.42	3-583660-7	5.928 150.57	6.240 158.5	6.686 169.82
40	3-583715-8	3.900 99.06	4.100 104.14	4.434 112.62	3-583679-8	4.875 123.83	5.125 130.18	5.509 139.93	3-583692-8	5.850 148.59	6.150 156.21	6.584 167.23	3-583660-8	6.084 154.53	6.396 162.46	6.842 173.79
41	3-583715-9	4.000 101.6	4.200 106.68	4.534 115.16	3-583679-9	5.000 127	5.250 133.35	5.634 143.1	3-583692-9	6.000 152.4	6.300 160.02	6.734 171.04	3-583660-9	6.240 158.5	6.552 166.42	6.998 177.75
42	4-583715-0	4.100 104.14	4.300 109.22	4.634 117.7	4-583679-0	5.125 130.18	5.375 136.53	5.759 146.28	4-583692-0	6.150 156.21	6.450 163.83	6.884 174.85	4-583660-0	6.396 162.46	6.708 170.38	7.154 181.71
43	4-583715-1	4.200 106.68	4.400 111.76	4.734 120.24	4-583679-1	5.250 133.35	5.500 139.7	5.884 149.45	4-583692-1	6.300 160.02	6.600 167.64	7.034 178.66	4-583660-1	6.552 166.42	6.864 174.35	7.310 185.67
44	4-583715-2	4.300 109.22	4.500 114.3	4.834 122.78	4-583679-2	5.375 136.53	5.625 142.88	6.009 152.63	4-583692-2	6.450 163.83	6.750 171.45	7.184 182.47	4-583660-2	6.708 170.38	7.020 178.31	7.466 189.64
45	4-583715-3	4.400 111.76	4.600 116.84	4.934 125.32	4-583679-3	5.500 139.7	5.750 146.05	6.134 155.8	4-583692-3	6.600 167.64	6.900 175.26	7.334 186.28	4-583660-3	6.864 174.35	7.176 182.27	7.622 193.6
46	4-583715-4	4.500 114.3	4.700 119.38	5.034 127.86	4-583679-4	5.625 142.88	5.875 149.23	6.259 158.98	4-583692-4	6.750 171.45	7.050 179.07	7.484 190.09	4-583660-4	7.020 178.31	7.332 186.23	7.778 197.56
47	4-583715-5	4.600 116.84	4.800 121.92	5.134 130.4	4-583679-5	5.750 146.05	6.000 152.0	6.384 162.15	4-583692-5	6.900 175.26	7.200 182.88	7.634 193.9	4-583660-5	7.176 182.27	7.488 190.2	7.934 201.52
48	4-583715-6	4.700 119.38	4.900 124.46	5.234 132.94	4-583679-6	5.875 149.23	6.125 155.58	6.509 165.33	4-583692-6	7.050 179.07	7.350 186.69	7.784 197.71	4-583660-6	7.332 186.23	7.644 194.16	8.090 205.49
49	4-583715-7	4.800 121.92	5.000 127	5.334 135.48	4-583679-7	6.000 152.4	6.250 158.75	6.634 168.5	4-583692-7	7.200 182.88	7.500 190.5	7.934 201.52	4-583660-7	7.488 190.2	7.800 198.12	8.246 209.45
50	4-583715-8	4.900 124.46	5.100 129.54	5.434 138.02	4-583679-8	6.125 155.58	6.375 161.93	6.759 171.68	4-583692-8	7.350 186.69	7.650 194.31	8.084 205.33	4-583660-8	7.644 194.16	7.956 202.08	8.402 213.41

Note: Sizes over 50 dual positions and custom contact patterns are available upon request. Also a card extender version of all connectors for test purposes is available. Consult AMP Incorporated for part numbers of these items.

Connector Assemblies Without End Caps .010 x .024 [0.25 x 0.61] Solder Posts (Not For Use with End Caps)

Contact Material and Finish:
Phosphor bronze — .000015 [0.00038]
Selective Gold over .000030 [0.00076] Nickel,
Solder Tine — Tin plated.

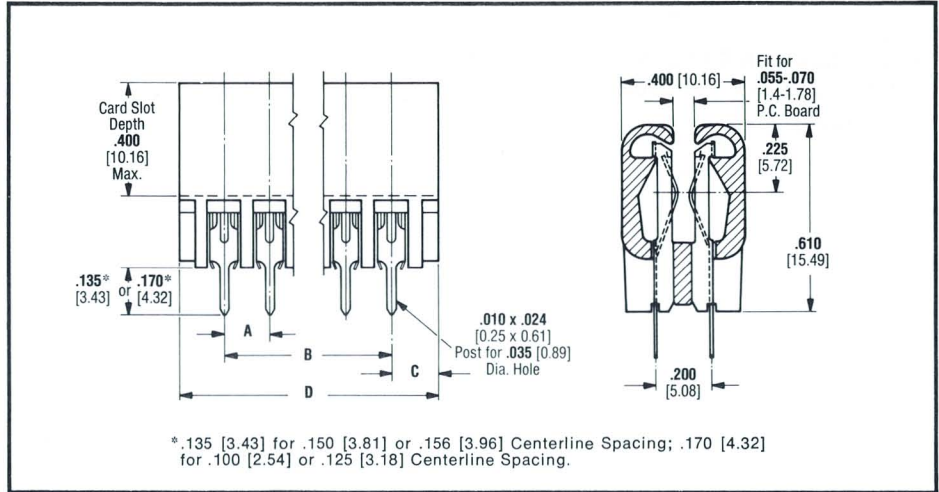

Dimensioning:
1. All dimensions in inches and millimetres. Values in brackets are metric equivalents.
2. Chart contains dimensions in inches over millimetres.

No. of Dual Pos.	A=.100 [2.54] Centerline Spacing				A=.125 [3.18] Centerline Spacing				A=.150 [3.81] Centerline Spacing				A=.156 [3.96] Centerline Spacing			
	Part No.	B	C	D	Part No.	B	C	D	Part No.	B	C	D	Part No.	B	C	D
3	583485-6	.200 5.08	.100 2.54	.400 10.16	583533-1	.250 6.35	.125 3.18	.500 12.7	583407-4	.300 7.62	.150 3.81	.600 15.24	4-583486-8	.312 7.92	.156 3.96	.624 15.85
4	583485-1	.300 7.62	.100 2.54	.500 12.7	583533-2	.375 9.53	.125 3.18	.625 15.88	583407-5	.450 11.43	.150 3.81	.750 19.05	4-583486-7	.468 11.89	.156 3.96	.780 19.81
5	583485-7	.400 10.16	.100 2.54	.600 15.24	583533-3	.500 12.7	.125 3.18	.750 19.05	583407-6	.600 15.24	.150 3.81	.900 22.86	4-583486-6	.624 15.85	.156 3.96	.936 23.77
6	583485-8	.500 12.7	.100 2.54	.700 17.78	583533-4	.625 15.88	.125 3.18	.875 22.23	583407-7	.750 19.05	.150 3.81	1.050 26.67	4-583486-5	.780 19.81	.156 3.96	1.092 27.74
7	583485-9	.600 15.24	.100 2.54	.800 20.32	583533-5	.750 19.05	.125 3.18	1.000 25.4	583407-8	.900 22.86	.150 3.81	1.200 30.48	4-583486-4	.936 23.77	.156 3.96	1.248 31.7
8	1-583485-0	.700 17.78	.100 2.54	.900 22.86	583533-6	.875 22.23	.125 3.18	1.125 28.58	583407-9	1.050 26.67	.150 3.81	1.350 34.29	4-583486-3	1.092 27.74	.156 3.96	1.404 35.66
9	1-583485-1	.800 20.32	.100 2.54	1.000 25.4	583533-7	1.000 25.4	.125 3.18	1.250 31.75	1-583407-0	1.200 30.48	.150 3.81	1.500 38.1	4-583486-2	1.248 31.7	.156 3.96	1.560 39.62
10	1-583485-2	.900 22.86	.100 2.54	1.100 27.94	583533-8	1.125 28.58	.125 3.18	1.375 34.93	1-583407-1	1.350 34.29	.150 3.81	1.650 41.91	4-583486-1	1.404 35.66	.156 3.96	1.716 43.59
11	1-583485-3	1.000 25.4	.100 2.54	1.200 30.48	583533-9	1.250 31.75	.125 3.18	1.500 38.1	1-583407-2	1.500 38.1	.150 3.81	1.800 45.72	4-583486-0	1.560 39.62	.156 3.96	1.872 47.55
12	1-583485-4	1.100 27.94	.100 2.54	1.300 33.02	1-583533-0	1.375 34.93	.125 3.18	1.625 41.28	1-583407-3	1.650 41.91	.150 3.81	1.950 49.53	3-583486-9	1.716 43.59	.156 3.96	2.028 51.51
13	1-583485-5	1.200 30.48	.100 2.54	1.400 35.56	1-583533-1	1.500 38.1	.125 3.18	1.750 44.45	583407-2	1.800 45.72	.150 3.81	2.100 53.34	3-583486-8	1.872 47.55	.156 3.96	2.184 55.47
14	1-583485-6	1.300 33.02	.100 2.54	1.500 38.1	1-583533-2	1.625 41.28	.125 3.18	1.875 47.63	1-583407-4	1.950 49.53	.150 3.81	2.250 57.15	3-583486-7	2.028 51.51	.156 3.96	2.340 59.44
15	583485-4	1.400 35.56	.100 2.54	1.600 40.64	1-583533-3	1.750 44.45	.125 3.18	2.000 50.8	1-583407-5	2.100 53.34	.150 3.81	2.400 60.96	3-583486-6	2.184 55.47	.156 3.96	2.496 63.4
16	1-583485-7	1.500 38.1	.100 2.54	1.700 43.18	1-583533-4	1.875 47.63	.125 3.18	2.125 53.98	1-583407-6	2.250 57.15	.150 3.81	2.550 64.77	3-583486-5	2.340 59.44	.156 3.96	2.652 67.36
17	1-583485-8	1.600 40.64	.100 2.54	1.800 45.72	1-583533-5	2.000 50.8	.125 3.18	2.250 57.15	1-583407-7	2.400 60.96	.150 3.81	2.700 68.58	3-583486-4	2.496 63.4	.156 3.96	2.808 71.32
18	1-583485-9	1.700 43.18	.100 2.54	1.900 48.26	1-583533-6	2.125 53.98	.125 3.18	2.375 60.33	1-583407-8	2.550 64.77	.150 3.81	2.850 72.39	3-583486-3	2.652 67.36	.156 3.96	2.964 72.29
19	2-583485-0	1.800 45.72	.100 2.54	2.000 50.8	1-583533-7	2.250 57.15	.125 3.18	2.580 63.5	1-583407-9	2.700 68.58	.150 3.81	3.000 76.2	3-583486-2	2.808 71.32	.156 3.96	3.120 79.25
20	2-583485-1	1.900 48.26	.100 2.54	2.100 53.34	1-583533-8	2.375 60.33	.125 3.18	2.625 66.68	2-583407-0	2.850 72.39	.150 3.81	3.150 80.01	3-583486-1	2.964 72.29	.156 3.96	3.276 83.21
21	2-583485-2	2.000 50.8	.100 2.54	2.200 55.88	1-583533-9	2.500 63.5	.125 3.18	2.750 69.85	2-583407-1	3.000 76.2	.150 3.81	3.300 83.82	3-583486-0	3.120 79.25	.156 3.96	3.432 87.17
22	2-583485-3	2.100 53.34	.100 2.54	2.300 58.42	2-583533-0	2.625 66.68	.125 3.18	2.875 73.03	2-583407-2	3.150 80.01	.150 3.81	3.450 87.63	2-583486-9	3.276 83.21	.156 3.96	8.588 91.14
23	2-483485-4	2.200 55.88	.100 2.54	2.400 60.96	2-583533-1	2.750 69.85	.125 3.18	3.000 76.2	583407-3	3.300 83.82	.150 3.81	3.600 91.44	2-583486-8	3.432 87.17	.156 3.96	3.744 95.1
24	2-583485-5	2.300 58.42	.100 2.54	2.500 63.5	2-583533-2	2.875 73.03	.125 3.18	3.125 79.38	2-583407-3	3.450 87.63	.150 3.81	3.750 95.25	2-583486-7	3.588 91.14	.156 3.96	3.900 99.06
25	2-583485-6	2.400 60.96	.100 2.54	2.600 66.04	2-583533-3	3.000 76.2	.125 3.18	3.250 82.55	2-583407-4	3.600 91.44	.150 3.81	3.900 99.06	2-583486-6	3.744 95.1	.156 3.96	4.056 103.02
26	2-583485-7	2.500 63.5	.100 2.54	2.700 68.58	2-583533-4	3.125 79.38	.125 3.18	3.375 85.73	2-583407-5	3.750 95.25	.150 3.81	4.050 102.87	2-583486-5	3.900 99.06	.156 3.96	4.212 106.99

Note: Sizes over 50 dual positions and custom contact patterns are available upon request. Also a card extender version of all connectors for test purposes is available. Consult AMP Incorporated for part numbers of these items.

Dimensioning:

1. All dimensions in inches and millimetres. Values in brackets are metric equivalents.
2. Chart contains dimensions in inches over millimetres.

Connector Assemblies Without End Caps
.010 x .024 [0.25 x 0.61] Solder Posts
 (Not For Use with End Caps)
 (Continued)

Contact Material and Finish:
 Phosphor bronze — .000015 [0.00038]
 Selective Gold over .000030 [0.00076] Nickel,
 Solder Tine — Tin plated

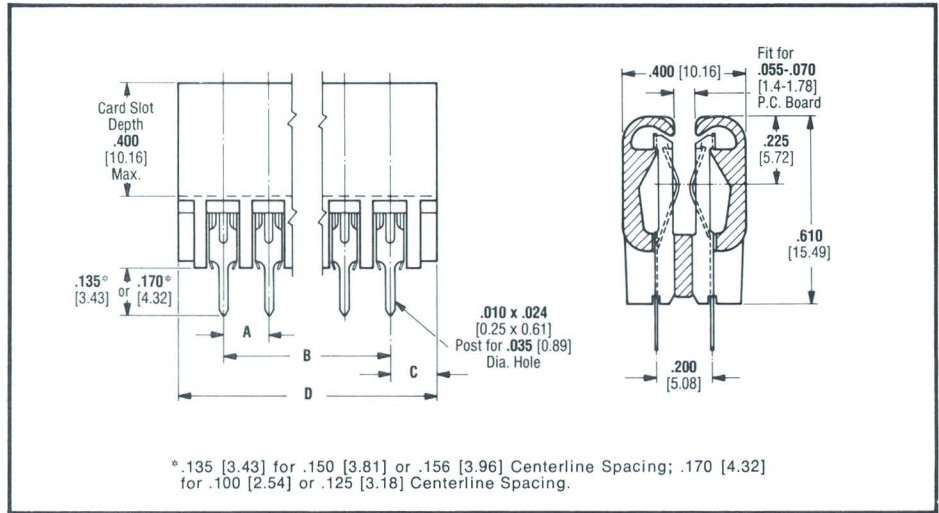

No. of Dual Pos.	A = .100 [2.54] Centerline Spacing				A = .125 [3.18] Centerline Spacing				A = .150 [3.81] Centerline Spacing				A = .156 [3.96] Centerline Spacing			
	Part No.	B	C	D	Part No.	B	C	D	Part No.	B	C	D	Part No.	B	C	D
27	2-583485-8	2.600 66.04	.100 2.54	2.800 71.12	2-583533-5	3.250 82.55	.125 3.18	3.500 88.9	2-583407-6	3.900 99.06	.150 3.81	4.200 106.68	2-583486-4	4.056 103.02	.156 3.96	4.368 110.95
28	2-583485-9	2.700 68.58	.100 2.54	2.900 73.66	2-583533-6	3.375 85.73	.125 3.18	3.625 92.08	583407-1	4.050 102.87	.150 3.81	4.350 110.49	2-583486-3	4.212 106.99	.156 3.96	4.524 114.91
29	3-583485-0	2.800 71.12	.100 2.54	3.000 76.2	2-583533-7	3.500 88.9	.125 3.18	3.750 95.25	2-583407-7	4.200 106.68	.150 3.81	4.500 114.3	2-583486-2	4.368 110.95	.156 3.96	4.680 118.87
30	3-583485-1	2.900 73.66	.100 2.54	3.100 78.74	2-583533-8	3.625 92.08	.125 3.18	3.875 98.43	2-583407-8	4.350 110.49	.150 3.81	4.650 118.11	2-583486-1	4.524 114.91	.156 3.96	4.836 122.83
31	3-583485-2	3.000 76.2	.100 2.54	3.200 81.28	2-583533-9	3.750 95.25	.125 3.18	4.000 101.6	2-583407-9	4.500 114.3	.150 3.81	4.800 121.92	2-583486-0	4.680 118.87	.156 3.96	4.992 126.8
32	3-583485-3	3.100 78.74	.100 2.54	3.300 83.82	3-583533-0	3.875 98.43	.125 3.18	4.125 104.78	3-583407-0	4.650 118.11	.150 3.81	4.950 125.73	1-583486-9	4.836 122.83	.156 3.96	5.148 130.76
33	3-583485-4	3.200 81.28	.100 2.54	3.400 86.36	3-583533-1	4.000 101.6	.125 3.18	4.250 107.95	3-583407-1	4.800 121.92	.150 3.81	5.100 129.54	1-583486-8	4.992 126.8	.156 3.96	5.304 134.72
34	5-583485-2	3.300 83.82	.100 2.54	3.500 88.9	3-583533-2	4.125 104.78	.125 3.18	4.375 111.13	3-583407-2	4.950 125.73	.150 3.81	5.250 133.35	1-583486-7	5.148 130.76	.156 3.96	5.460 138.68
35	3-583485-5	3.400 86.36	.100 2.54	3.600 91.44	3-583533-3	4.250 107.95	.125 3.18	4.500 114.3	3-583407-3	5.100 129.54	.150 3.81	5.400 137.16	1-583486-6	5.304 134.72	.156 3.96	5.616 142.65
36	3-583485-6	3.500 88.9	.100 2.54	3.700 93.98	3-583533-4	4.375 111.13	.125 3.18	4.625 117.48	3-583407-4	5.250 133.35	.150 3.81	5.550 140.97	1-583486-5	5.460 138.68	.156 3.96	5.772 146.61
37	3-583485-7	3.600 91.44	.100 2.54	3.800 96.52	3-583533-5	4.500 114.3	.125 3.18	4.750 120.65	3-583407-5	5.400 137.16	.150 3.81	5.700 144.78	1-583486-4	5.616 142.65	.156 3.96	5.928 150.57
38	3-583485-8	3.700 93.98	.100 2.54	3.900 99.06	3-583533-6	4.625 117.48	.125 3.18	4.875 123.83	3-583407-6	5.550 140.97	.150 3.81	5.850 148.59	1-583486-3	5.772 146.61	.156 3.96	6.084 154.53
39	3-583485-9	3.800 96.52	.100 2.54	4.000 101.6	3-583533-7	4.750 120.65	.125 3.18	5.000 127	3-583407-7	5.700 144.87	.150 3.81	6.000 152.4	1-583486-2	5.928 150.57	.156 3.96	6.240 158.5
40	4-583485-0	3.900 99.06	.100 2.54	4.100 104.14	3-583533-8	4.875 123.83	.125 3.18	5.125 130.18	3-583407-8	5.850 148.59	.150 3.81	6.150 156.21	1-583486-1	6.084 154.53	.156 3.96	6.396 162.46
41	4-583485-1	4.000 101.6	.100 2.54	4.200 106.68	3-583533-9	5.000 127	.125 3.18	5.250 133.35	3-583407-9	6.000 152.4	.150 3.81	6.300 160.02	1-583486-0	6.240 158.5	.156 3.96	6.552 166.42
42	4-583485-2	4.100 104.14	.100 2.54	4.300 109.22	4-583533-0	5.125 130.18	.125 3.18	5.375 136.53	4-583407-0	6.150 156.21	.150 3.81	6.450 163.83	583486-9	6.396 162.36	.156 3.96	6.708 170.38
43	4-583485-3	4.200 106.68	.100 2.54	4.400 111.76	4-583533-1	5.250 133.35	.125 3.18	5.500 139.7	4-583407-1	6.300 160.02	.150 3.81	6.600 167.64	583486-8	6.552 166.42	.156 3.96	6.864 174.35
44	4-583485-4	4.300 109.22	.100 2.54	4.500 114.3	4-583533-2	5.375 136.53	.125 3.18	5.625 142.88	4-583407-2	6.450 163.83	.150 3.81	6.750 171.45	583486-7	6.708 170.38	.156 3.96	7.020 178.31
45	4-583485-5	4.400 111.76	.100 2.54	4.600 116.84	4-583533-3	5.500 139.7	.125 3.18	5.750 146.15	4-583407-3	6.600 167.64	.150 3.81	6.900 175.26	583486-6	6.864 174.35	.156 3.96	7.176 182.27
46	4-583485-6	4.500 114.3	.100 2.54	4.700 119.38	4-583533-4	5.625 142.88	.125 3.18	5.875 149.23	4-583407-4	6.750 171.45	.150 3.81	7.050 179.07	583486-5	7.020 178.31	.156 3.96	7.332 186.23
47	4-583485-7	4.600 116.84	.100 2.54	4.800 121.92	4-583533-5	5.750 146.05	.125 3.18	6.000 152.4	4-583407-5	6.900 175.26	.150 3.81	7.200 182.88	583486-4	7.176 182.27	.156 3.96	7.488 190.2
48	4-583485-8	4.700 119.38	.100 2.54	4.900 124.46	4-583533-6	5.875 149.23	.125 3.18	6.125 155.58	4-583407-6	7.050 179.07	.150 3.81	7.350 186.69	583486-3	7.332 186.23	.156 3.96	7.644 194.16
49	4-583485-9	4.800 121.92	.100 2.54	5.000 127	4-583533-7	6.000 152.4	.125 3.18	6.250 158.75	4-583407-7	7.200 182.88	.150 3.81	7.500 190.5	583486-2	7.488 190.2	.156 3.96	7.800 198.12
50	583485-3	4.900 124.46	.100 2.54	5.100 129.54	4-583533-8	6.125 155.58	.125 3.18	6.375 161.93	4-583407-8	7.350 186.69	.150 3.81	7.650 194.31	583486-1	7.644 194.16	.156 3.96	7.956 202.08

Note: Sizes over 50 dual positions and custom contact patterns are available upon request. Also a card extender version of all connectors for test purposes is available. Consult AMP Incorporated for part numbers of these items.

Dimensioning:
 1. All dimensions in inches and millimetres.
 Values in brackets are metric equivalents.
 2. Chart contains dimensions in inches over millimetres.

Connector Assemblies .031 [0.79] Sq. Wrap-Type Posts (With and Without End Caps)

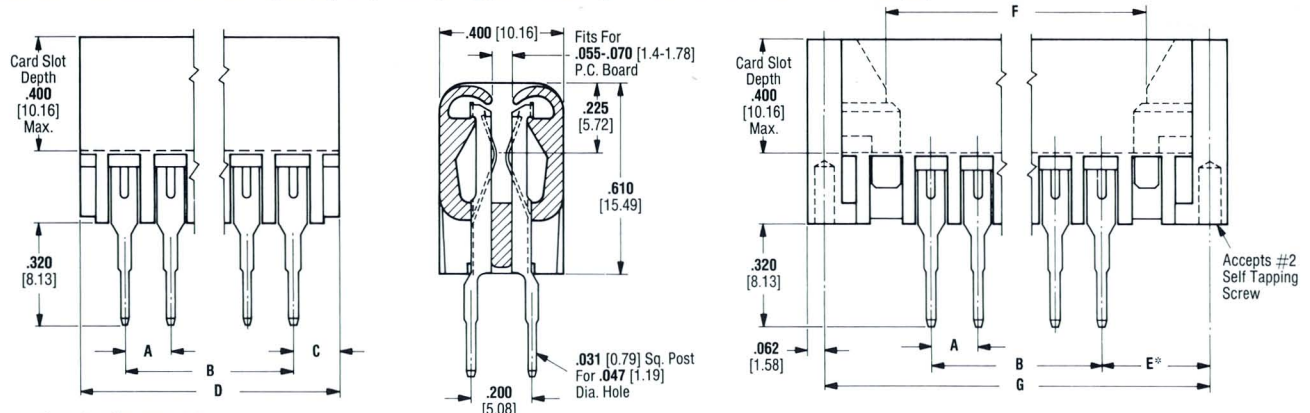

*See mounting details, page 9.

Without End Caps

With End Caps

No. of Dual Pos.	A = .150 [3.81] Centerline Spacing				A = .156 [3.96] Centerline Spacing				A = .150 [3.81] Centerline Spacing				A = .156 [3.96] Centerline Spacing			
	Part No.	B	C	D	Part No.	B	C	D	Part No.	B	C	D	Part No.	B	C	D
3	583752-1	.300 7.62	.150 3.81	.600 15.24	583753-1	.312 7.92	.156 3.96	.624 15.85	583754-1	.300 7.62	.600 15.24	1.034 26.26	583755-1	.312 7.92	.624 15.85	1.070 27.18
4	583752-2	.450 11.43	.150 3.81	.750 19.05	583753-2	.468 11.89	.156 3.96	.780 19.81	583754-2	.450 11.43	.750 19.05	1.184 30.07	583755-2	.468 11.89	.780 19.81	1.226 31.14
5	583752-3	.600 15.24	.150 3.81	.900 22.86	583753-3	.624 15.85	.156 3.96	.936 23.77	583754-3	.600 15.24	.900 22.86	1.334 33.88	583755-3	.624 15.85	.936 23.77	1.382 35.1
6	583752-4	.750 19.05	.150 3.81	1.050 26.67	583753-4	.780 19.81	.156 3.96	1.092 27.74	583754-4	.750 19.05	1.050 26.67	1.484 37.69	583755-4	.780 19.81	1.092 27.74	1.538 39.07
7	583752-5	.900 22.86	.150 3.81	1.200 30.48	583753-5	.936 23.77	.156 3.96	1.248 31.7	583754-5	.900 22.86	1.200 30.48	1.634 41.5	583755-5	.936 23.77	1.248 31.7	1.694 43.03
8	583752-6	1.050 26.67	.150 3.81	1.350 34.29	583753-6	1.092 27.74	.156 3.96	1.404 35.66	583754-6	1.050 26.67	1.350 34.29	1.784 45.31	583755-6	1.092 27.74	1.404 35.66	1.850 46.99
9	583752-7	1.200 30.48	.150 3.81	1.500 38.1	583753-7	1.248 31.7	.156 3.96	1.560 39.62	583754-7	1.200 30.48	1.500 38.1	1.934 49.12	583755-7	1.248 31.7	1.560 39.62	2.006 50.95
10	583752-8	1.350 34.29	.150 3.81	1.650 41.91	583753-8	1.404 35.66	.156 3.96	1.716 43.59	583754-8	1.350 34.29	1.650 41.91	2.084 52.93	583755-8	1.404 35.66	1.716 43.59	2.162 54.91
11	583752-9	1.500 38.1	.150 3.81	1.800 45.72	583753-9	1.560 39.62	.156 3.96	1.872 47.55	583754-9	1.500 38.1	1.800 45.72	2.234 56.74	583755-9	1.550 39.62	1.872 47.55	2.318 58.88
12	1-583752-0	1.650 41.91	.150 3.81	1.950 49.53	1-583753-0	1.716 43.59	.156 3.96	2.028 51.51	1-583754-0	1.650 41.91	1.950 49.53	2.384 60.55	1-583755-0	1.716 43.59	2.028 51.51	2.474 62.84
13	1-583752-1	1.800 45.72	.150 3.81	2.100 53.34	1-583753-1	1.872 47.55	.156 3.96	2.184 55.47	1-583754-1	1.800 45.72	2.100 53.34	2.534 64.36	1-583755-1	1.872 47.55	2.184 55.47	2.630 66.8
14	1-583752-2	1.950 49.53	.150 3.81	2.250 57.15	1-583753-2	2.028 51.51	.156 3.96	2.340 59.44	1-583754-2	1.950 49.53	2.250 57.15	2.684 68.17	1-583755-2	2.028 51.51	2.340 59.44	2.786 70.76
15	1-583752-3	2.100 53.34	.150 3.81	2.400 60.96	1-583753-3	2.184 55.47	.156 3.96	2.496 63.4	1-583754-3	2.100 53.34	2.400 60.96	2.834 71.98	1-583755-3	2.184 55.47	2.496 63.4	2.942 74.73
16	1-583752-4	2.250 57.15	.150 3.81	2.550 64.77	1-583753-4	2.340 59.44	.156 3.96	2.652 67.36	1-583754-4	2.250 57.15	2.550 64.77	2.984 75.79	1-583755-4	2.340 59.44	2.652 67.36	3.098 78.7
17	1-583752-5	2.400 60.96	.150 3.81	2.700 68.58	1-583753-5	2.496 63.4	.156 3.96	2.808 71.32	1-583754-5	2.400 60.96	2.700 68.58	3.134 79.6	1-583755-5	2.496 63.4	2.808 71.32	3.254 82.65
18	1-583752-6	2.550 64.77	.150 3.81	2.850 72.39	1-583753-6	2.652 67.36	.156 3.96	2.964 72.29	1-583754-6	2.550 64.77	2.850 72.39	3.284 83.41	1-583755-6	2.652 67.36	2.964 75.29	3.410 86.61
19	1-583752-7	2.700 68.58	.150 3.81	3.000 76.2	1-583753-7	2.808 71.32	.156 3.96	3.120 79.25	1-583754-7	2.700 68.58	3.000 76.2	3.434 87.22	1-583755-7	2.808 71.32	3.120 79.25	3.566 90.58
20	1-583752-8	2.850 72.39	.150 3.81	3.150 80.01	1-583753-8	2.964 72.29	.156 3.96	3.276 83.21	1-583754-8	2.850 72.39	3.150 80.01	3.584 91.03	1-583755-8	2.964 75.29	3.276 83.21	3.722 94.54
21	1-583752-9	3.000 76.2	.150 3.81	3.300 83.82	1-583753-9	3.120 79.25	.156 3.96	3.432 87.17	1-583754-9	3.000 76.2	3.300 83.82	3.734 94.84	1-583755-9	3.120 79.25	3.432 87.17	3.878 98.5
22	2-583752-0	3.150 80.01	.150 3.81	3.450 87.63	2-583753-0	3.276 83.21	.156 3.96	3.588 91.14	2-583754-0	3.150 80.01	3.450 87.63	3.884 98.65	2-583755-0	3.276 83.21	3.588 91.14	4.034 102.46
23	2-583752-1	3.300 83.82	.150 3.81	3.600 91.44	2-583753-1	3.432 87.17	.156 3.96	3.744 95.1	2-583754-1	3.300 83.82	3.600 91.44	4.034 102.46	2-583755-1	3.432 87.17	3.744 95.1	4.190 106.43
24	2-583752-2	3.450 87.63	.150 3.81	3.750 95.25	2-583753-2	3.588 91.14	.156 3.96	3.900 99.06	2-583754-2	3.450 87.63	3.750 95.25	4.184 106.27	2-583755-2	3.588 91.14	3.900 99.06	4.346 110.39
25	2-583752-3	3.600 91.44	.150 3.81	3.900 99.06	2-583753-3	3.744 95.1	.156 3.96	4.056 103.02	2-583754-3	3.600 91.44	3.900 99.06	4.334 110.08	2-583755-3	3.744 95.1	4.056 103.02	4.052 114.35
26	2-583752-4	3.750 95.25	.150 3.81	4.050 102.87	2-583753-4	3.900 99.06	.156 3.96	4.212 106.99	2-583754-4	3.750 95.25	4.050 102.87	4.484 113.89	2-583755-4	3.900 99.06	4.212 106.98	4.658 118.31

Note: Sizes over 50 dual positions, custom contact patterns and other post lengths are available upon request. Consult AMP Incorporated for part numbers.

Dimensioning:

1. All dimensions in inches and millimetres. Values in brackets are metric equivalents.
2. Chart contains dimensions in inches over millimetres.

Connector Assemblies .031 [0.79] Sq. Wrap-Type Posts (Continued)
(With and Without End Caps)

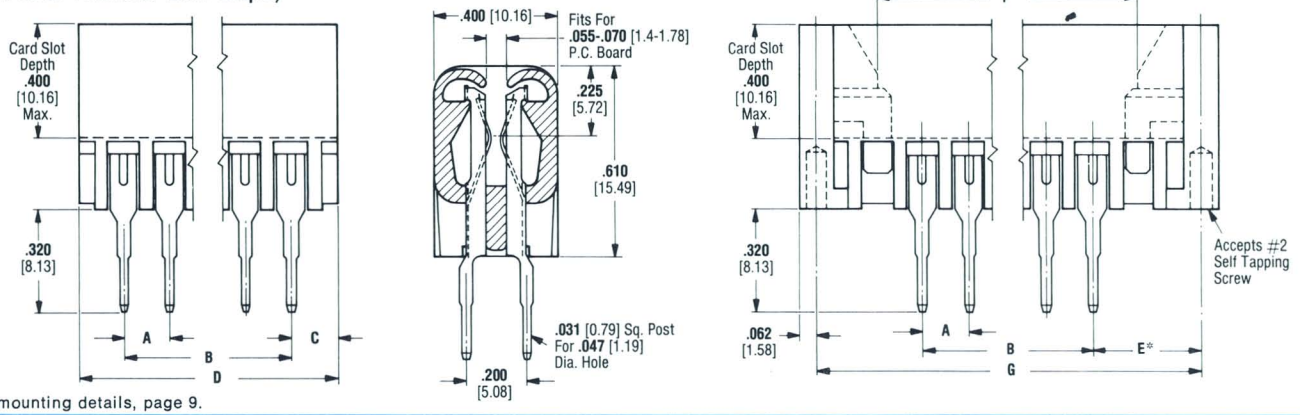

*See mounting details, page 9.

Without End Caps

With End Caps

No. of Dual Pos.	A=.150 [3.81] Centerline Spacing				A=.156 [3.96] Centerline Spacing				A=.150 [3.81] Centerline Spacing				A=.156 [3.96] Centerline Spacing			
	Part No.	B	C	D	Part No.	B	C	D	Part No.	B	C	D	Part No.	B	C	D
27	2-583752-5	3.900 99.06	.150 3.81	4.200 106.68	2-583753-5	4.056 103.02	.156 3.96	4.368 110.95	2-583754-5	3.900 99.06	4.200 106.68	4.634 117.7	2-583755-5	4.056 103.02	4.368 110.95	4.814 122.28
28	2-583752-6	4.050 102.87	.150 3.81	4.350 110.49	2-583753-6	4.212 106.99	.156 3.96	4.524 114.91	2-583754-6	4.050 102.87	4.350 110.49	4.784 121.51	2-583755-6	4.212 106.98	4.524 114.91	4.970 126.24
29	2-583752-7	4.200 106.68	.150 3.81	4.500 114.3	2-583753-7	4.368 110.95	.156 3.96	4.680 118.87	2-583754-7	4.200 106.68	4.500 114.3	4.934 125.32	2-583755-7	4.368 110.95	4.680 118.87	5.126 130.2
30	2-583752-8	4.350 110.49	.150 3.81	4.650 118.11	2-583753-8	4.524 114.91	.156 3.96	4.836 122.83	2-583754-8	4.350 110.49	4.650 118.11	5.084 129.13	2-583755-8	4.524 114.91	4.836 122.83	5.282 134.16
31	2-583752-9	4.500 114.3	.150 3.81	4.800 121.92	2-583753-9	4.680 118.87	.156 3.96	4.992 126.8	2-583754-9	4.500 114.3	4.800 121.92	5.234 132.94	2-583755-9	4.680 118.87	4.992 126.8	5.438 138.12
32	3-583752-0	4.650 118.11	.150 3.81	4.950 125.73	3-583753-0	4.836 122.83	.156 3.96	5.148 130.76	3-583754-0	4.650 118.11	4.950 125.73	5.384 136.75	3-583755-0	4.836 122.83	5.148 130.76	5.594 142.09
33	3-583752-1	4.800 121.92	.150 3.81	5.100 129.54	3-583753-1	4.992 126.8	.156 3.96	5.304 134.72	3-583754-1	4.800 121.92	5.100 129.54	5.534 140.56	3-583755-1	4.992 126.8	5.304 134.72	5.750 146.05
34	3-583752-2	4.950 125.73	.150 3.81	5.250 133.35	3-583753-2	5.148 130.76	.156 3.96	5.460 138.68	3-583754-2	4.950 125.73	5.250 133.35	5.684 144.37	3-583755-2	5.148 130.76	5.460 138.68	5.906 150.01
35	3-583752-3	5.100 129.54	.150 3.81	5.400 137.16	3-583753-3	5.304 134.72	.156 3.96	5.616 142.65	3-583754-3	5.100 129.54	5.400 137.16	5.834 148.18	3-583755-3	5.304 134.72	5.616 142.65	6.062 153.97
36	3-583752-4	5.250 133.35	.150 3.81	5.550 140.97	3-583753-4	5.460 138.68	.156 3.96	5.772 146.61	3-583754-4	5.250 133.35	5.550 140.97	5.984 151.99	3-583755-4	5.460 138.64	5.772 146.61	6.218 157.94
37	3-583752-5	5.400 137.16	.150 3.81	5.700 144.78	3-583753-5	5.616 142.65	.156 3.96	5.928 150.57	3-583754-5	5.400 137.16	5.700 144.78	6.134 155.8	3-583755-5	5.616 142.65	5.928 150.57	6.374 161.9
38	3-583752-6	5.550 140.97	.150 3.81	5.850 148.59	3-583753-6	5.772 146.61	.156 3.96	6.084 154.53	3-583754-6	5.550 140.97	5.850 148.59	6.284 159.61	3-583755-6	5.772 146.61	6.084 154.53	6.530 165.86
39	3-583752-7	5.700 144.87	.150 3.81	6.000 152.4	3-583753-7	5.928 150.57	.156 3.96	6.240 158.5	3-583754-7	5.700 144.78	6.000 152.4	6.434 163.42	3-583755-7	5.928 150.57	6.240 158.5	6.686 169.82
40	3-583752-8	5.850 148.59	.150 3.81	6.150 156.21	3-583753-8	6.084 154.53	.156 3.96	6.396 162.46	3-583754-8	5.850 148.59	6.150 156.21	6.584 167.23	3-583755-8	6.084 154.53	6.396 162.46	6.842 173.79
41	3-583752-9	6.000 152.4	.150 3.81	6.300 160.02	3-583753-9	6.240 158.5	.156 3.96	6.552 166.42	3-583754-9	6.000 152.4	6.300 160.02	6.734 171.04	3-583755-9	6.240 158.5	6.552 166.42	6.998 177.75
42	4-583752-0	6.150 156.21	.150 3.81	6.450 163.83	4-583753-0	6.396 162.46	.156 3.96	6.708 170.38	4-583754-0	6.150 156.21	6.450 163.83	6.884 174.85	4-583755-0	6.396 162.46	6.708 170.38	7.154 181.71
43	4-583752-1	6.300 160.02	.150 3.81	6.600 167.64	4-583753-1	6.552 166.42	.156 3.96	6.864 174.35	4-583754-1	6.300 160.02	6.600 167.64	7.034 178.66	4-583755-1	6.552 166.42	6.864 174.35	7.310 185.67
44	4-583752-2	6.450 163.83	.150 3.81	6.750 171.45	4-583753-2	6.708 170.38	.156 3.96	7.020 178.31	4-583754-2	6.450 163.83	6.750 171.45	7.184 182.47	4-583755-2	6.708 170.38	7.020 178.31	7.466 189.64
45	4-583752-3	6.600 167.64	.150 3.81	6.900 175.56	4-583753-3	6.864 174.35	.156 3.96	7.176 182.27	4-583754-3	6.600 167.64	6.900 175.26	7.334 186.28	4-583755-3	6.864 174.35	7.176 182.27	7.622 193.6
46	4-583752-4	6.750 171.45	.150 3.81	7.050 179.07	4-583753-4	7.020 178.31	.156 3.96	7.332 186.23	4-583754-4	6.750 171.45	7.050 179.07	7.484 190.09	4-583755-4	7.020 173.31	7.332 186.23	7.778 197.56
47	4-583752-5	6.900 175.26	.150 3.81	7.200 182.88	4-583753-5	7.176 182.27	.156 3.96	7.488 190.2	4-583754-5	6.900 175.26	7.200 182.88	7.634 193.9	4-583755-5	7.176 182.27	7.488 190.2	7.934 201.52
48	4-583752-6	7.050 179.07	.150 3.81	7.350 186.69	4-583753-6	7.332 186.23	.156 3.96	7.644 194.16	4-583754-6	7.050 179.07	7.350 186.69	7.784 197.71	4-583755-6	7.332 186.23	7.644 194.16	8.090 205.49
49	4-583752-7	7.200 182.88	.150 3.81	7.500 190.5	4-583753-7	7.488 190.2	.156 3.96	7.800 198.12	4-583754-7	7.200 182.88	7.500 190.5	7.934 201.52	4-583755-7	7.488 190.2	7.800 198.12	8.246 209.45
50	4-583752-8	7.350 186.69	.150 3.81	7.650 194.31	4-583753-8	7.644 194.16	.156 3.96	7.956 202.08	4-583754-8	7.350 186.69	7.650 194.31	8.084 205.33	4-583755-8	7.644 194.16	7.956 202.08	8.402 213.41

Note: Sizes over 50 dual positions, custom contact patterns and other post lengths are available upon request. Consult AMP Incorporated for part numbers.

Dimensioning:

1. All dimensions in inches and millimetres. Values in brackets are metric equivalents.
2. Charts contain dimensions in inches and millimetres.

Card Guides

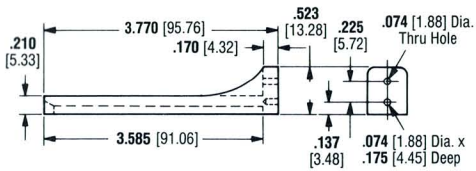

SINGLE SLOTTED

Part No.: 583671-1

Material: Glass Filled Nylon — Black

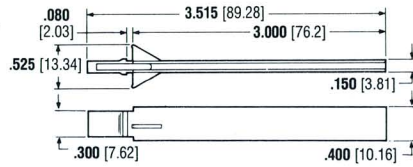

DOUBLE SLOTTED WITH STANDOFF*

Part No.: 583408-1

Material: Nylon — Natural

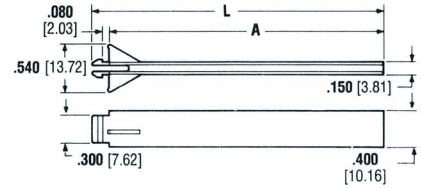

DOUBLE SLOTTED WITHOUT STANDOFF*

Material: Nylon — Natural

Part Number	A	L
583425-1	1.500 38.1	1.680 42.67
583425-4	3.000 76.2	3.180 80.77

Typical Connector and Card Guide Assembly

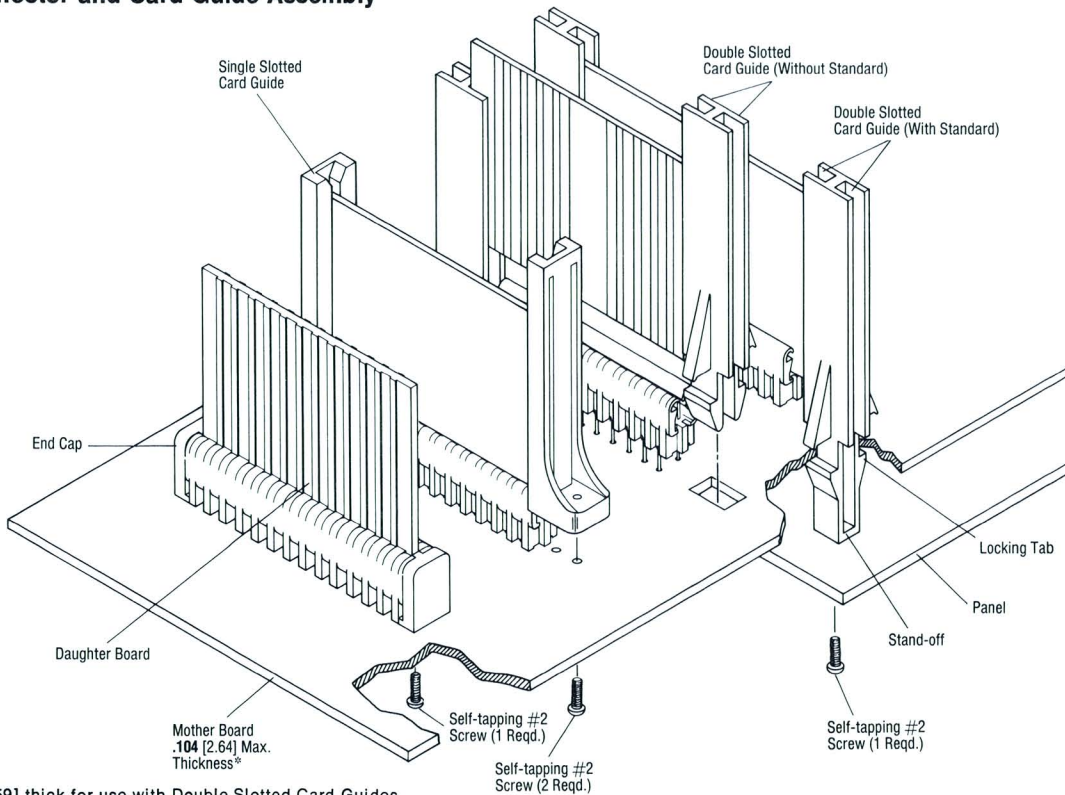

*Must be 1/16" [1.59] thick for use with Double Slotted Card Guides.

Mounting

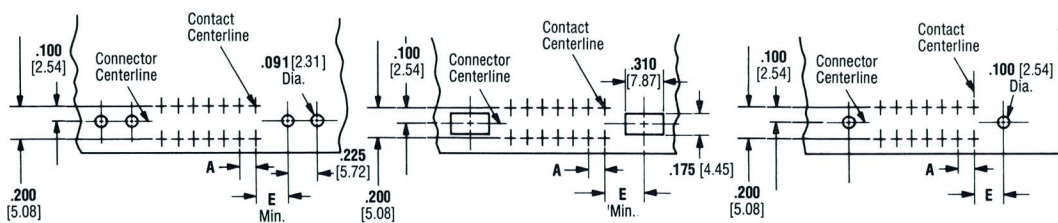

SINGLE SLOTTED CARD GUIDE

DOUBLE SLOTTED CARD GUIDE

CONNECTOR WITH END CAPS

Contact Mounting Hole Diameter: .010 x .024 [0.25 x 0.61] Post — .035 [0.89] Dia.
.031 [0.79] sq. Post — .047 [1.19] Dia.

Description	A	E
Connector with End Caps	.100	.267
	2.54	6.78
	.125	.317
	3.18	8.05
	.150	.367
	3.81	9.32
Single Slotted Card Guide	.156	.379
	3.96	9.62
	.100	.263
	2.54	6.68
	.125	.288
	3.18	7.31
Double Slotted Card Guide	.150	.313
	3.81	7.95
	.156	.319
	3.96	8.1
	.100	.328
	2.54	8.33
Double Slotted Card Guide	.125	.353
	3.18	8.96
	.150	.378
	3.81	9.6
	.156	.384
	3.96	9.75

Dimensioning:

1. All dimensions in inches and millimetres. Values in brackets are metric equivalents.
2. Charts contain dimensions in inches over millimetres.

Typical Assembly (With Keying Plugs)

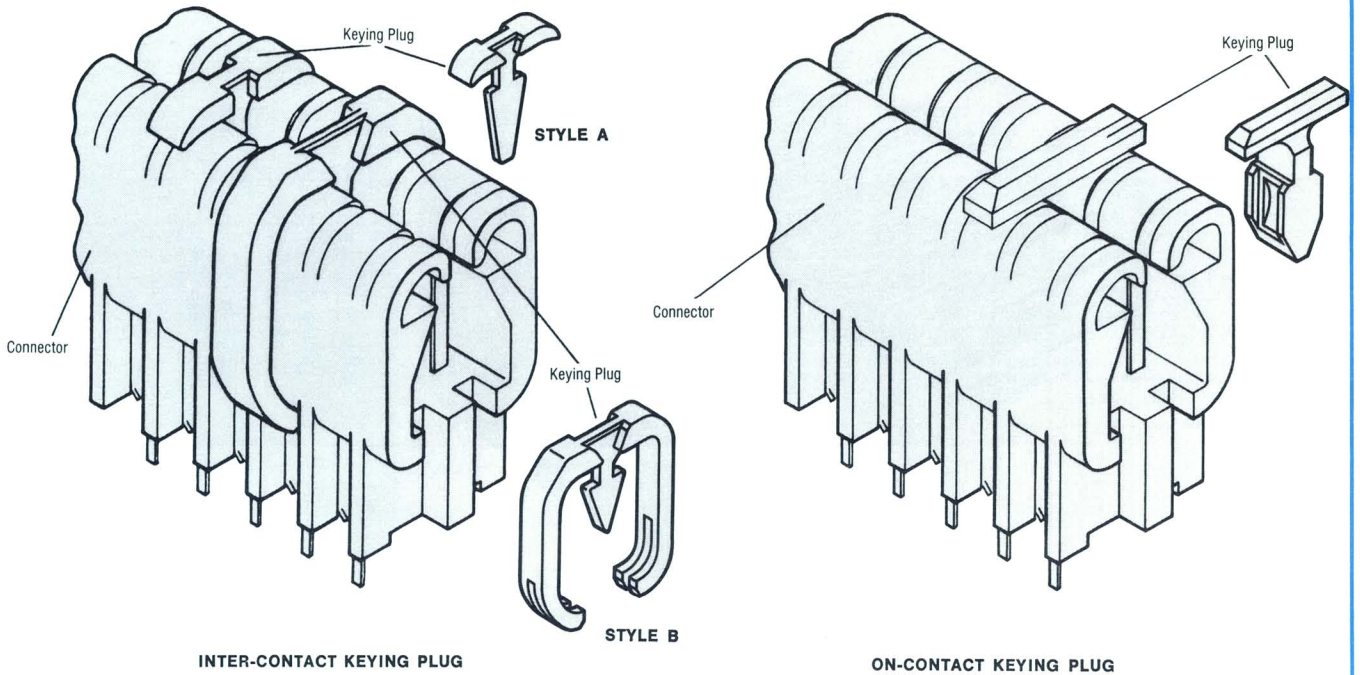

INTER-CONTACT KEYING PLUG

ON-CONTACT KEYING PLUG

Printed Circuit Board Cutout for Keying Plugs

INTER-CONTACT KEYING PLUGS				
Connector Centerline Spacing	A (Min)	Part Number		Recommended Insertion Tool No.
		Style A	Style B	
.100	.040	530030-2	530286-1	91081-2
2.54	1.01			
.125	.050	530030-1	530286-2	91081-1
3.18				
.150	.156	583714-1	583714-2	91088-1
3.81				

ON-CONTACT KEYING PLUG			
Connector Centerline Spacing	A (Min)	Part Number	Recommended Insertion Tool No.
2.54	.125	583714-2	91088-2
.125	3.27		
.150	.160	583714-2	91088-2
3.81			
.156	.156	583714-2	91088-2
3.96			

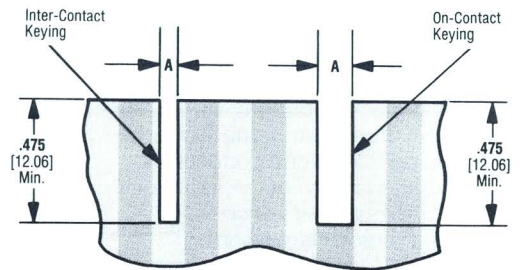

Post Wrapping

Wire Size		N (turns)	Insulation Dia. Max.	Bit* No.	Sleeve* No.
AWG	mm ²				
30	0.05	8	.027 0.69	507502	507100
28	0.08-0.09	7	.031 0.79	509205	502129
26	0.12-0.15	6	.044 1.12	506420	502129
24	0.2	5	.044 1.12	505415	502129

* Recommended Gardner-Denver Tooling Numbers (or equivalent).

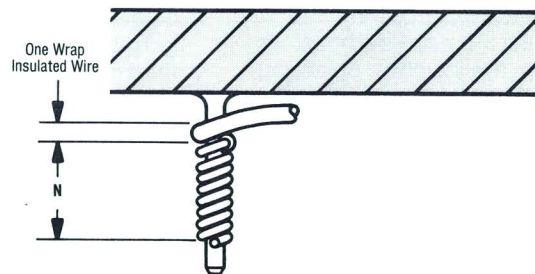

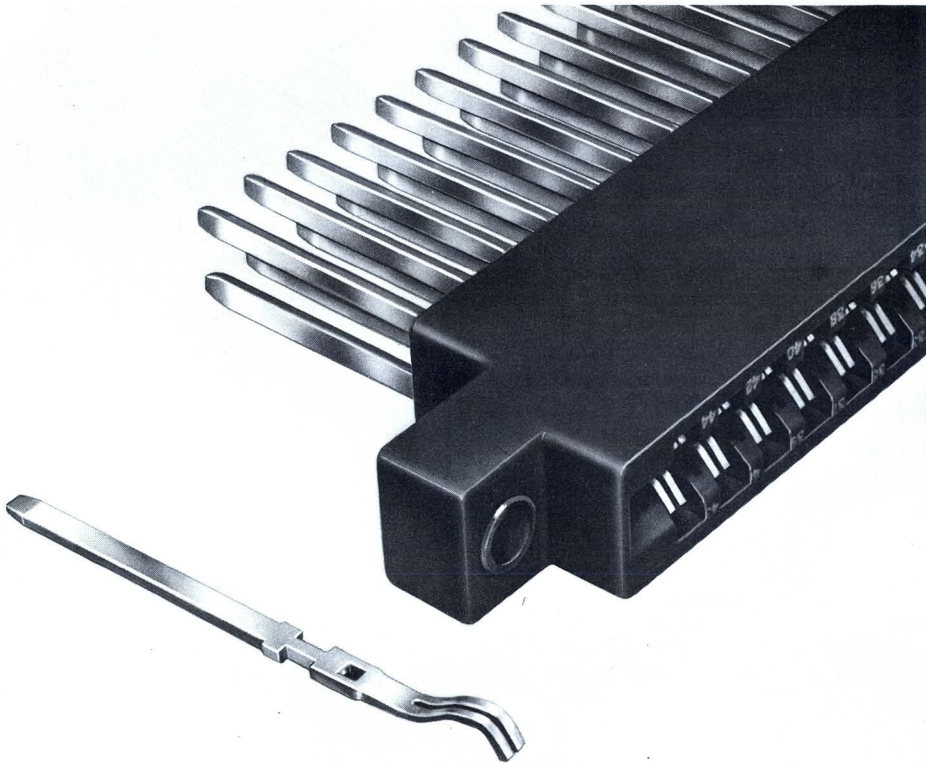

AMP TERMI-TWIST Connectors are reliable, low cost one-piece contact, PC card edge connectors designed to meet your requirements for frame, chassis or panel mounting with either automatic or manual wiring. These versatile printed circuit connectors are the basis for one of the industries most complete series of sizes, configurations, finishes and materials. This adaptability enables you to match your specific Interconnection System Application Requirements (ISAR) to the proper connector combinations.

The protected entry housings accommodate PC boards from .054 to .071 thick and are available with a wide range of dual readout positions and featured contact centerlines. Additional features of the housings include the availability of polarizing keys, marking styles, and alternate mounts.

Contacts are firmly secured in the housings by locking shoulders which are formed when the post ends of the contacts are twisted 90° during assembly. The contact area is bifurcated for redundancy and

smoother insertion and withdrawal of uneven boards. This design feature, complemented by the availability of AMP's proven gold over nickel plating, assures excellent performance, both electrically and mechanically. "They're as Good as Gold." All connectors are furnished with one-piece contacts easily removed for servicing or replacement by the use of a simple extraction tool.

AMP TERMI-TWIST Connectors offer the most economical combination of reliability and product efficiency for packaging and interconnecting PC boards. Used in a variety of panel assembly arrangements, these connectors can be terminated automatically by the accurate and highly efficient TERMI-POINT System II. This numerically-controlled machine is capable of applying 1000 programmed wires to an array of connector posts in a one-hour period. For limited production, you may select any one of several equally reliable manual and semi-automatic TERMI-POINT hand tools. These connectors are also compatible with wrap-type wiring.

TERMI-TWIST Connectors

Features

- Low cost per line
- Locking shoulders firmly secure contact in housing
- Adaptability of connectors to automatic TERMI-POINT System II wiring machine assures greatest economy and production efficiency
- One-piece contacts are bifurcated for redundancy and are easily removed with simple extraction tool
- Choice of finishes include varied thicknesses of gold-over-nickel plating plus selective plating on contact tip for longer life and greater economy
- Housing materials include glass filled phenolic, and diallyl phthalate
- Housings loaded in one or both sides and available with polarizing keys
- Connector sizes provide a wide selection of contact positions — contacts on .100", .125", .156", .200" centers
- Post configurations compatible with TERMI-POINT clip technique, wrap-type terminations or solder applications

Note: All dimensions in inches.

Specifications subject to change. Consult AMP Incorporated for latest design specifications.

Contact Bifurcation

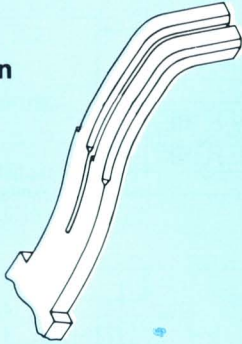

Post for TERMI-POINT Clip or Wrap Type Wiring

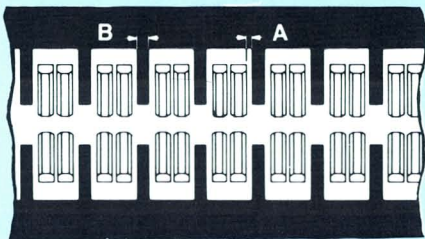

Contact Cavity

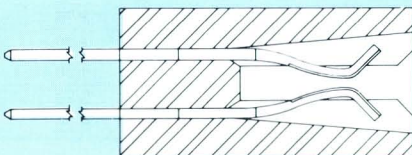

P.C. Board Entry

Contact Bifurcation

AMP's unique bifurcation is an important design feature that provides redundant contact points. It allows independent deflection of either contact tyne to assure the highest probability of uninterrupted continuity with the presence of foreign material on the board surface. This greatly enhances the reliability of the connection. Contacts are removable by using a simple extraction tool.

The chamfered edge provides a smooth surface for minimum board wear and uniform insertion and extraction forces.

The tapered beam design provides a more precise range of forces over the specified range of P.C. board thickness and resists stress relaxation in operating environments.

Post Quality

Post quality and tolerances are maintained by utilizing the accuracy of the stamping technique to insure high performance of a metal clip retained by stored energy.

Contact Cavity

The narrow gap between bifurcation is designed to provide greater side clearance (A) with maximum barrier thickness (B) for greater strength and dielectric qualities. This also eliminates susceptibility of interference between the contact and the housing.

P.C. Board Entry

The recessed contact provides protected entry which prevents contact collapsing or stubbing during board insertion.

A deep chamfer is utilized on the housing to provide easy lead-in which minimizes board damage and facilitates insertion of warped P.C. boards.

Operating Parameters

All AMP TERMI-TWIST Connectors are designed to accept P.C. boards per MIL-STD-275 and to meet the requirements of AMP Product Specifications 108-14007 and 108-14009. Some of these operating parameters include:

Operating Temperature— -65°C to $+125^{\circ}\text{C}$ (continuous)

Contact Rating:

.022 x .036 contacts – 3 amps continuous

.031 x .062 contacts – 5 amps continuous

Contact Engaging and Separation Force— 1 oz. (min.) to 16 oz. (max.)

Test results include other parameters:

Insulation Resistance
Dielectric Withstanding Voltage
Contact Resistance
Temperature Cycling
Vibration and Shock
Durability and Humidity

Test Reports

—(available on request)

.022 x .036 – GPR 575-74

.031 x .062 – GPR 575-64

Housing Materials: Diallyl phthalate, type SDG-F (blue) or phenolic, type MFH (black) per MIL-M-14.

Contact Material: Phosphor bronze per QQ-B-750.

Contact Plating: .000005" min. gold over .000100" min. nickel — post area.

See table below for plating thickness on contact area.

Gold plating per MIL-G-45204, Type II, nickel plating per QQ-N-290.

Polarizing Key: Nylon Material Intercontact type, Part Number 67342; Contact Replacement Type Part Number 67343.

Housing Marking: Style 41 (shown) is standard.

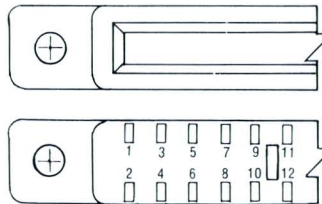
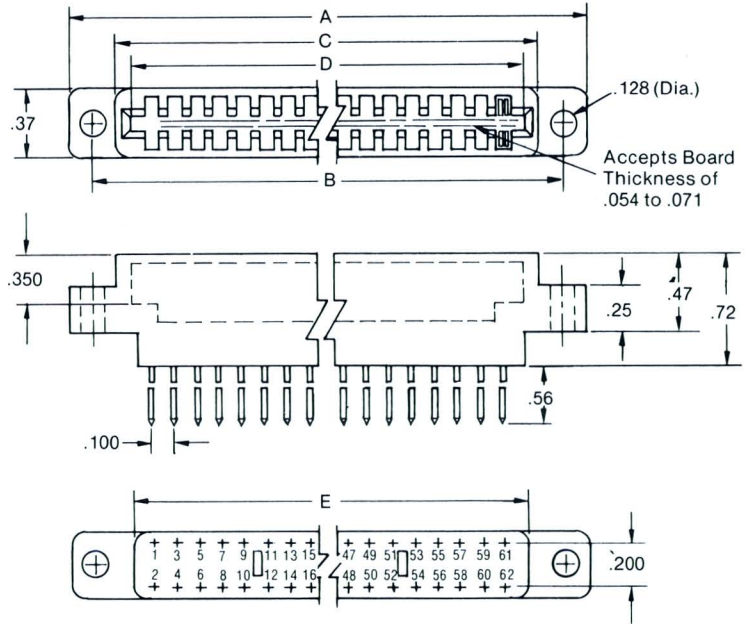

Housing Marking

Post Size: .022" x .036"

Replacement Contact: Part Number 1-67763-8
Contact Replacement Tool: Part Number 265831-1

No. of Dual Positions	Part Numbers		A	B	C	D	E
	Diallyl Housing .000030 Selective Gold Plating	Phenolic Housing .000015 Selective Gold Plating					
15	1-67880-1	2-67880-4	2.34	2.075	1.76	1.605	1.76
18	1-67880-2	2-67880-5	2.64	2.375	2.06	1.905	2.06
22	1-67880-3	2-67880-6	3.04	2.775	2.46	2.305	2.46
25	1-67880-4	2-67880-7	3.34	3.075	2.76	2.605	2.76
28	1-67880-5	2-67880-8	3.64	3.375	3.06	2.905	3.06
30	1-67880-6	2-67880-9	3.84	3.575	3.26	3.105	3.26
31	1-67880-7	3-67880-0	3.94	3.675	3.36	3.205	3.36
34	1-67880-8	3-67880-1	4.24	3.975	3.66	3.505	3.66
35	1-67880-9	3-67880-2	4.34	4.075	3.76	3.605	3.76
40	2-67880-0	3-67880-3	4.84	4.575	4.26	4.105	4.26
43	2-67880-1	3-67880-4	5.14	4.875	4.56	4.405	4.56
50	2-67880-2	3-67880-5	5.84	5.575	5.26	5.105	5.26
60	2-67880-3	3-67880-6	6.84	6.575	6.26	6.105	6.26

Housing Materials: Diallyl phthalate, type SDG-F (blue) or phenolic, type MFH (black) per MIL-M-14.

Contact Material: Phosphor bronze per QQ-B-750.

Contact Plating: .000005" min. gold over .000100" min. nickel — post area. See table below for plating thickness on contact area.

Gold plating per MIL-G-45204, Type II, nickel plating per QQ-N-290.

Polarizing Key: Nylon material, intercontact type, Part Number 67654-1, Contact Replacement Type Part Number 67372-1.

Housing Marking:

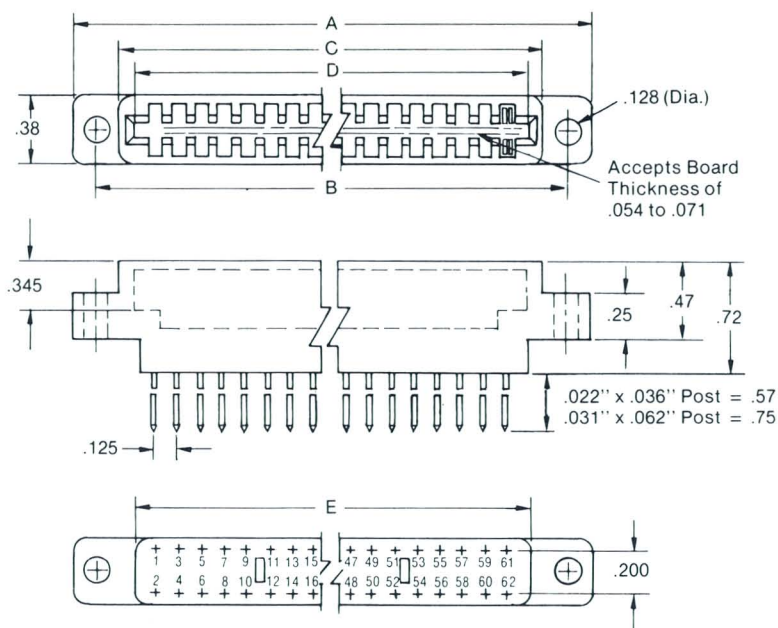
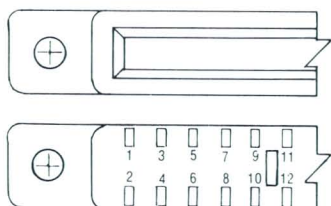

Post Size: .022" x .036"

Replacement Contact: Part Number 67621-3
Contact Replacement Tool: Part Number 265831-1

No. of Dual Positions	Part Numbers		A	B	C	D	E
	Diallyl Housing .000030 Selective Gold Plating	Phenolic Housing .000015 Selective Gold Plating					
12	67782-2	1-67782-3	2.125	1.875	1.625	1.502	1.625
15	67782-3	1-67782-4	2.500	2.250	2.000	1.877	2.000
18	67782-4	1-67782-5	2.875	2.625	2.375	2.252	2.375
22	67782-5	1-67782-6	3.375	3.125	2.875	2.752	2.875
28	67782-6	1-67782-7	4.125	3.875	3.625	3.502	3.625
30	67782-7	1-67782-8	4.375	4.125	3.875	3.752	3.875
31	67782-8	1-67882-9	4.500	4.250	4.000	3.877	4.000
36	67782-9	2-67782-0	5.125	4.875	4.625	4.502	4.625
40	1-67782-0	2-67782-1	5.625	5.375	5.125	5.002	5.125
43	1-67782-1	2-67782-2	6.000	5.750	5.500	5.377	5.500
50	1-67782-2	2-67782-3	6.875	6.625	6.375	6.252	6.375

Post Size: .031" x .062"

Replacement Contact: Part Number 67603-3
Contact Replacement Tool: Part Number 265831-3

No. of Dual Positions	Part Numbers		A	B	C	D	E
	Diallyl Housing .000030 Selective Gold Plating	Phenolic Housing .000015 Selective Gold Plating					
12	67952-4	1-67952-5	2.125	1.875	1.625	1.502	1.625
15	67952-5	1-67952-6	2.500	2.250	2.000	1.877	2.000
18	67952-6	1-67952-7	2.875	2.625	2.375	2.252	2.375
22	67952-7	1-67952-8	3.375	3.125	2.875	2.752	2.875
28	67952-8	1-67952-9	4.125	3.875	3.625	3.502	3.625
30	67952-9	2-67952-0	4.375	4.125	3.875	3.752	3.875
31	1-67952-0	2-67952-1	4.500	4.250	4.000	3.877	4.000
36	1-67952-1	2-67952-2	5.125	4.875	4.625	4.502	4.625
40	1-67952-2	2-67952-3	5.625	5.375	5.125	5.002	5.125
43	1-67952-3	2-67952-4	6.000	5.750	5.500	5.377	5.500
50	1-67952-4	2-67952-5	6.875	6.625	6.375	6.252	6.375

Housing Material: Diallyl phthalate, type SDG-F (blue) or phenolic, type MFH (black) per MIL-M-14.

Contact Material: Phosphor bronze per QQ-B-750.

Contact Plating: .000005" min. gold over .000100" min. nickel — post area. See table below for plating thickness on contact area.

Gold plating per MIL-G-45204, Type II, nickel plating per QQ-N-290.

Polarizing Keys: Nylon material, Intercontact type, Part Number 67704-4; Contact Replacement Type Part Number 67372.

Housing Marking: Style 45 (shown) is standard.

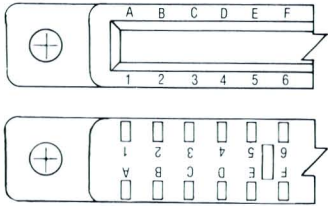
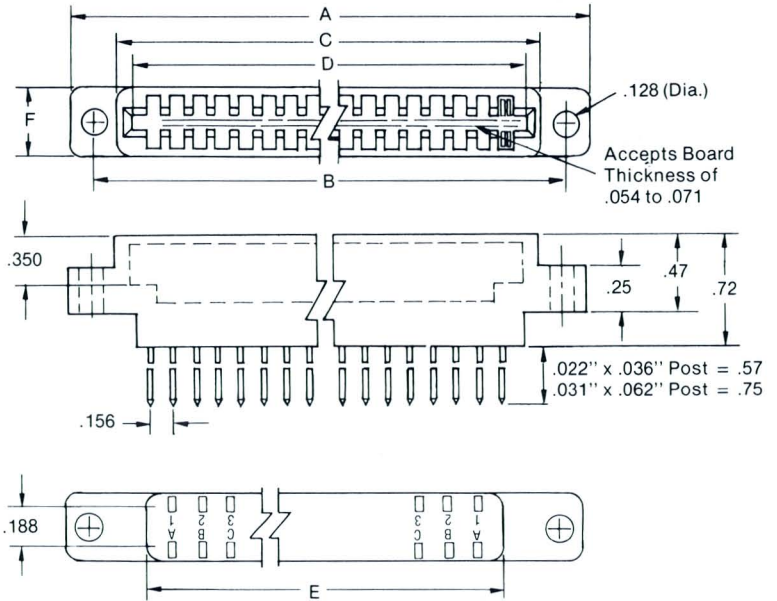

Post Size: .022" x .036"

Replacement Contact: Part Number 67698-9
Contact Replacement Tool: Part Number 265831-1

No. of Dual Positions	Part Numbers		A	B	C	D	E	F
	Diallyl Housing .000030 Selective Gold Plating	Phenolic Housing .000015 Selective Gold Plating						
10	67686-2	1-67686-2	2.41	2.158	1.89	1.724	1.62	.35
15	67686-3	1-67686-3	3.19	2.938	2.607	2.504	2.40	.35
18	67686-4	1-67686-4	3.66	3.406	3.14	2.972	2.86	.35
22	67686-5	1-67686-5	4.28	4.030	3.76	3.596	3.49	.35
25	67686-6	1-67686-6	4.82	4.498	4.18	4.064	3.97	.44
28	67686-7	1-67686-7	5.29	4.966	4.65	4.532	4.44	.44
30	67686-8	1-67686-8	5.60	5.278	4.96	4.844	4.75	.44
32	67686-9	1-67686-9	5.91	5.540	5.27	5.156	5.06	.44
36	1-67686-0	2-67686-0	6.54	6.214	5.90	5.780	5.68	.44
43	1-67686-1	2-67686-1	7.63	7.306	6.99	6.872	6.78	.44

Post Size: .031" x .062"

Replacement Contact: Part Number 7-67018-5
Contact Replacement Tool: Part Number 265831-3

No. of Dual Positions	Part Numbers		A	B	C	D	E	F
	Diallyl Housing .000030 Selective Gold Plating	Phenolic Housing .000015 Selective Gold Plating						
10	67824-2	1-67824-2	2.41	2.158	1.89	1.724	1.62	.35
15	67824-3	1-67824-3	3.19	2.938	2.67	2.504	2.40	.35
18	67824-4	1-67824-4	3.66	3.406	3.14	2.972	2.86	.35
22	67824-5	1-67824-5	4.28	4.030	3.76	3.596	3.49	.35
25	67824-6	1-67824-6	4.82	4.498	4.18	4.064	3.97	.44
28	67824-7	1-67824-7	5.29	4.966	4.65	4.532	4.44	.44
30	67824-8	1-67824-8	5.60	5.278	4.96	4.844	4.75	.44
32	67824-9	1-67824-9	5.91	5.590	5.27	5.156	5.06	.44
36	1-67824-0	2-67824-0	6.54	6.214	5.90	5.780	5.68	.44
43	1-67824-1	2-67824-1	7.63	7.306	6.99	6.872	6.78	.44

Accessory and Wiring Specifications

Card Guides

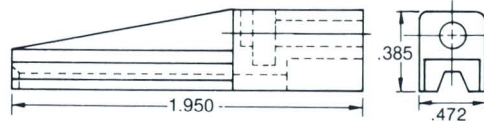

Part No. 67762-1 (Blue)
Part No. 67762-2 (Black)
Glass-filled Nylon Material

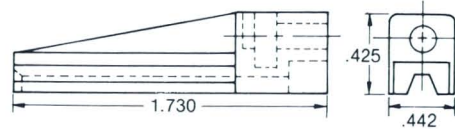

Part No. 67764-1 (Black)
Part No. 67764-2 (Blue)
Glass-filled Nylon Material

Alternate Mounting and Marking Styles

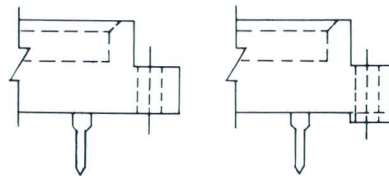

Alternate Mounting Styles— Available with flush or offset mounting ears and threaded inserts. Contact AMP Incorporated.

Marking Styles— Alternate Marking Styles available. For information consult your AMP Sales Engineer or contact AMP Incorporated, Harrisburg, Pa.

Type of Characters: Ivory ink stamped.

TERMI-POINT Tool and Clip Specifications

The Technique

Physically, the TERMI-POINT clip termination consists of a wire, solid or stranded, connected to a rectangular bronze clip and retained under sustained pressure. Mechanical energy is stored in the clip in the form of elastic stresses which are generated when the clip and wire are applied to the post. In essence, it is a compressed spring which maintains a continual force between the wire and post, even under extreme environmental conditions.

The clip and wire are applied simultaneously to the post by means of a tool which may be hand-held or mounted on a numerically-controlled machine. In actual operation of the tool, the wire is stripped of insulation, pre-formed and applied to the post under the clip. During this installation cycle, wire and post surfaces are mechanically cleaned to establish large contact surfaces.

This technique combines the best features of wire-stripping and permanent crimp termination with the maintainability and serviceability of a separable connection.

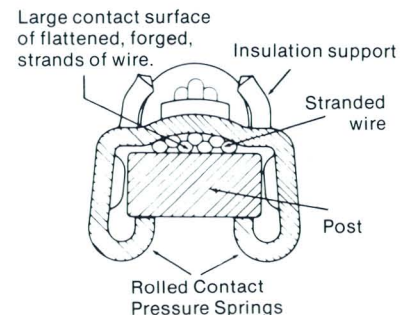
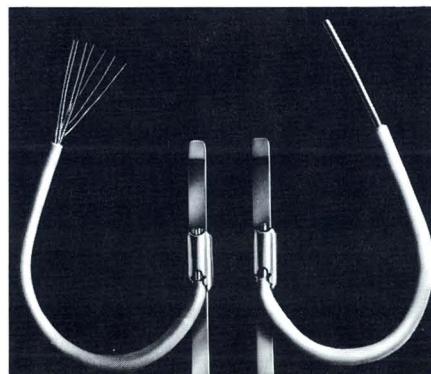

TERMI-POINT Tool and Clip Specifications



Pneumatic Hand Tool No. 265161-2



Manual Service Tool No. 69535



**Pneumatic Hand Tool No. 265575-1
and Pneumatic Tool No. 265580-1**



Manual Service Tool No. 69526-2

.022 x .036 AMP Post Size

Pneumatic Hand Tool No. 265161-2 and Manual Service Tool No. 69535

Wire Size Solid or Stranded (7 Str.)	Insulation Dia. Range	Mandrel Insert Number	Mandrel Color Code	Clip Number (2500 per reel)	
				Gold Plated	Tin-Nickel Plated
28	.018-.029	69545-1	Black		
30	.018-.029	69545-3	White	67042-2	67042-1
32	.018-.029	69545-2	Gray		

.031 x .062 AMP Post Size

Pneumatic Hand Tool No. 265575-1 and Pneumatic Tool No. 265580-1 (For Use With Semi-automatic Wiring Machines)

Wire Size Solid or Stranded (7 Str.)	Insulation Dia. Range	Mandrel Insert Number	Mandrel and Clip Color Code	Clip Number (1000 per reel)		
				Electro-Tin Plated	Gold Plated	Tin-Nickel Plated
22	.036-.045	265070-1	Orange	4-330495-2	4-330495-9	6-330495-8
	.046-.055	265070-2				
	.056-.065	265070-3				
24	.034-.045	265070-4	Red	2-330495-1	2-330495-2	6-330495-4
	.046-.055	265070-5				
26	.056-.065	265070-6	Brown	1-330495-3	1-330495-8	8-330495-4
	.030-.045	265070-7				
28	.046-.055	265070-8	Black	3-330495-5	9-330495-6	8-330495-8
	.022-.033	265070-9				
	.034-.045	1-265070-0				

Manual Service Tool No. 69526-2

Wire Size Solid or Stranded (7 Str.)	Insulation Dia. Range	Mandrel Insert Number	Mandrel and Clip Color Code	Clip Number (1000 per reel)		
				Electro-Tin Plated	Gold Plated	Tin-Nickel Plated
22	.036-.045	69551-8	Orange	6-330495-1	6-330495-2	6-330495-7
	.046-.065	1-69411-4				
24	.034-.045	69551-9	Red	5-330495-3	1-330495-9	6-330495-3
	.046-.065	1-69411-3				
26	.022-.045	69551-6	Brown	5-330495-5	9-330495-8	8-330495-6
	.046-.055	1-69411-9				
28	.022-.045	69551-5	Black	5-330495-9	330495-3	9-330495-0



Pull Test Tool

Part No. 69358-6 .022 x .036 Post
Part No. 69358-2 .031 x .062 Post



Clip Extraction Tool

Part No. 69357-5 .022 x .036 Post
Part No. 69357-3 .031 x .062 Post



Clip Extraction Captive Tool

Part No. 69445



Post Replacement Tool

Part No. 265831-2 .022 x .036 Post
Part No. 265831-3 .031 x .062 Post

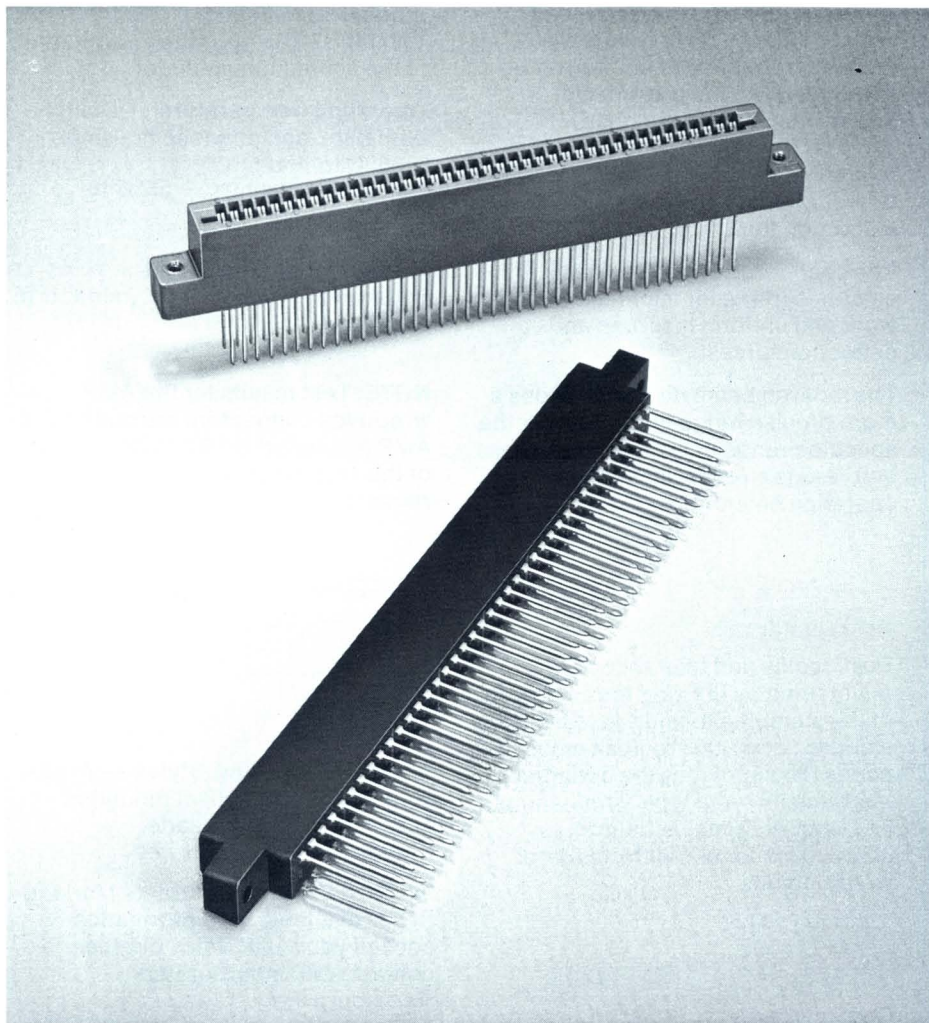

This AMP Connector line is specifically designed and application/cost engineered to meet your requirements for the packaging and interconnection of printed circuit boards using standard wrap type tooling. These reliable one-piece card entry connectors employ miniature size posts which are compatible with the .025" sq. termination technology.

The closed entry housings are made of either diallyl phthalate, phenolic, or polyester and are available in a variety of sizes and configurations offering a wide range of dual contact positions and contact centerline spacings. They accommodate pc boards from .054" to .071" thick and provide many additional features including the availability of polarizing keys and replacement contacts.

All housings are furnished with one-piece removable contacts, bifurcated for redundancy. They are easily removed for servicing or replacement by use of a simple extraction tool. This design feature complemented by the availability of AMP's proven gold-over-nickel plating, assures excellent performance, both electrically and mechanically.

This line of AMP Connectors combines reliability with product efficiency for economically packaging and interconnecting pc boards. They can be used in a variety of panel assembly arrangements and can be terminated by the numerically controlled wrap type machine for volume production or by hand tools and semi-automatic machines for smaller production requirements.

Wrap-Type Printed Circuit Connectors



Features

- Post tip engineered for wiring by automatic, semi-automatic and hand Wrap Type Tooling.
- Contacts incorporate miniature size posts for complete compatibility with .025" sq. termination technology.
- Housings furnished in a variety of sizes and configurations — dual contact positions other than those listed can also be supplied.
- Polarizing keys are available.
- One-piece contacts are bifurcated for redundancy and are removable using simple extraction tool.
- Low per line cost.

Contact Bifurcation

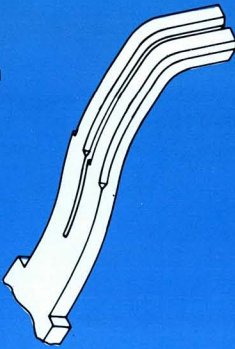

Post For Wrap Type Wiring

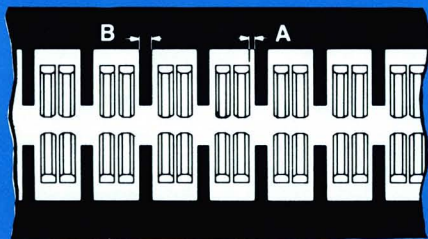
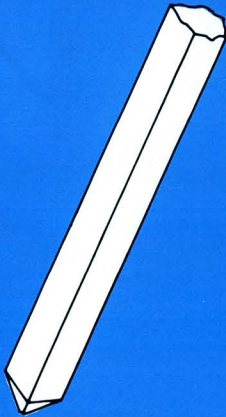

Contact Cavity

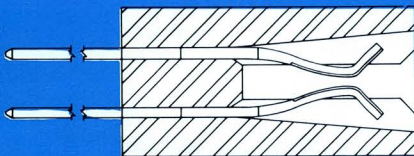

P.C. Board Entry

Contact Bifurcation

AMP's unique bifurcation is an important design feature that provides redundant contact points. It allows independent deflection of either contact tyne to assure the highest probability of uninterrupted continuity with the presence of foreign material on the board surface. This greatly enhances the reliability of the connection. Contacts are removable by using a simple extraction tool.

The chamfered edge provides a smooth surface for minimum board wear and uniform insertion and extraction forces.

The tapered beam design provides a more precise range of forces over the specified range of pc board thickness and resists stress relaxation in operating environments.

Post Quality

Post quality and tolerances are maintained by utilizing the accuracy of the stamping technique to insure standard max. .003 radius on post edges. This provides the optimum interface for wrap type terminations. The post diagonal is held to .0315/.0345 for use with standard wrapping bits.

Contact Cavity

The narrow bifurcated gap between bifurcation is designed to provide greater side clearance (A) with maximum barrier thickness (B) for greater strength and dielectric qualities. This also eliminates susceptibility of interference between the contact and the housing.

P.C. Board Entry

The recessed contact provides closed entry which prevents contact collapsing or stubbing during board insertion.

A deep chamfer is utilized on the housing to provide easy lead-in which minimizes board damage and facilitates insertion of warped P.C. boards.

Operating Parameters

These AMP Connectors are designed to accept pc boards per MIL-STD-275 and to meet the requirements of AMP product specifications 108-14007 and 108-14009. The operating parameters of the connectors include:

Operating Temperature — Diallyl phthalate and phenolic housings: -65°C to +125°C.
Polyester housings: -55°C to +105°C.

Contact Engagement and Separation Force — 1 oz. (min.) to 16 oz. (max.)

NOTE: Test results for the AMP wrap-type connectors are outlined in AMP test report GPR 575-84. Copies of this test report are available upon request.

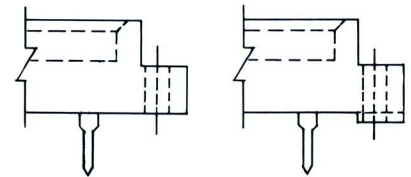

Alternate Mounting Styles — Available with flush or offset mounting ears and threaded inserts. Contact AMP Incorporated.

Marking Styles — Alternate Marking Styles available. For information consult your AMP Sales Engineer or contact AMP Incorporated, Harrisburg, Pa.
Type of Characters: Ivory ink stamped

Contact Replacement Tool



Part Number	Post Size
265831-1	.025 ²
265831-3	.031 x .062

Centerline Spacing: .100 x .200
 Post Size: .025" square equivalent *

Current Rating: 3 amps continuous

Housing Materials: Diallyl phthalate, type SDG-F (blue) or phenolic; type MFH (black) per MIL-M-14

Contact Material: Phosphor bronze per QQ-B-750

Contact Plating: .000005" min. gold over .000100" min. nickel — post area.
 See table below for plating thickness on contact area.

Gold plating per MIL-G-45204, Type II, nickel plating per QQ-N-290.

Polarizing Key: Nylon material intercontact type, Part Number 67342. Contact replacement 67343.

Replacement Contact: Part Number 67826-6.

Contact Replacement Tool: Part Number 265831-1

* AMP's miniature post (.022" x .027") has the same cross section diagonal as the .025" sq. post and is approved by Gardner-Denver for hand, semi-automatic and automatic wrap-type applications using the .025" sq. termination technique.

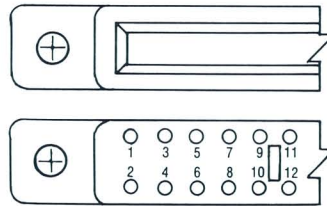
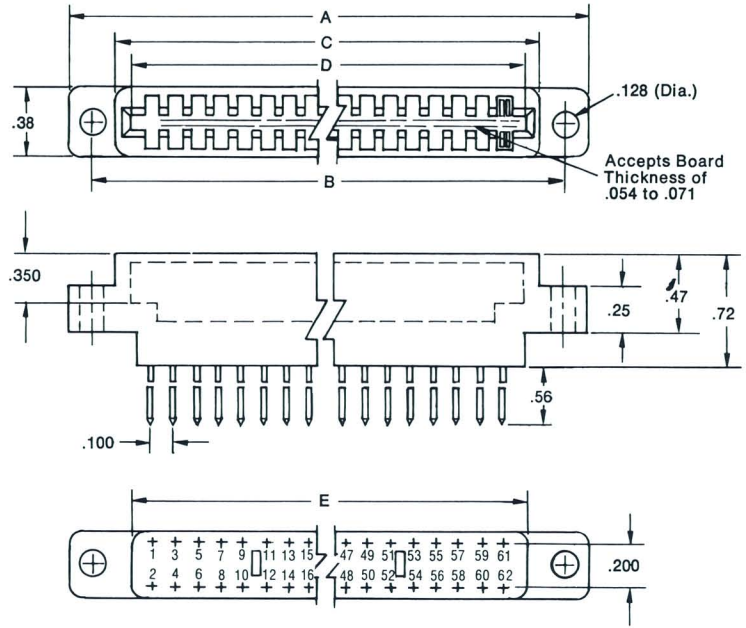

Housing Marking

No. of Dual Positions	Part Numbers			A	B	C	D	E
	Diallyl Phthalate Housing		Phenolic Housing					
	.000030 Selective Gold Plating	.000030 Selective Gold Plating	.000015 Selective Gold Plating					
15	67962-1	3-67962-0	67962-2	2.34	2.075	1.76	1.605	1.76
18	67962-3	3-67962-1	67962-4	2.64	2.375	2.06	1.905	2.06
22	67962-5	3-67962-2	67962-6	3.04	2.775	2.46	2.305	2.46
25	67962-7	3-67962-3	67962-8	3.34	3.075	2.76	2.605	2.76
28	67962-9	3-67962-4	1-67962-0	3.64	3.375	3.06	2.905	3.06
30	1-67962-1	3-67962-5	1-67962-2	3.84	3.575	3.26	3.105	3.26
31	1-67962-3	3-67962-6	1-67962-4	3.94	3.675	3.36	3.205	3.36
34	1-67962-5	3-67962-7	1-67962-6	4.24	3.975	3.66	3.505	3.66
35	1-67962-7	3-67962-8	1-67962-8	4.34	4.075	3.76	3.605	3.76
40	1-67962-9	3-67962-9	2-67962-0	4.84	4.575	4.26	4.105	4.26
43	2-67962-1	4-67962-0	2-67962-2	5.14	4.875	4.56	4.405	4.56
50	2-67962-3	4-67962-1	2-67962-4	5.84	5.575	5.26	5.105	5.26
60	2-67962-5	4-67962-2	2-67962-6	6.84	6.575	6.26	6.105	6.26

Centerline Spacing: .125 x .250
Post Size: .025" square equivalent *

Current Rating: 3 amps continuous

Housing Materials: Diallyl phthalate, type SDG-F (blue) or phenolic; type MFH (black) per MIL-M-14

Contact Material: Phosphor bronze per QQ-B-750

Contact Plating: .000005" min. gold over .000100" min. nickel — post area.
 See table below for plating thickness on contact area.

Gold plating per MIL-G-45204, Type II, nickel plating per QQ-N-290.

Polarizing Key: Nylon material intercontact type, Part Number 67654-1.

Contact Replacement Type 67372

Replacement Contact: Part Number 2-67875-0.

Contact Replacement Tool: Part Number 265831-1

* AMP's miniature post (.022" x .027") has the same cross section diagonal as the .025" sq. post and is approved by Gardner-Denver for hand, semi-automatic and automatic wrap-type applications using the .025" sq. termination technique.

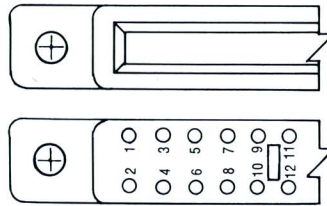
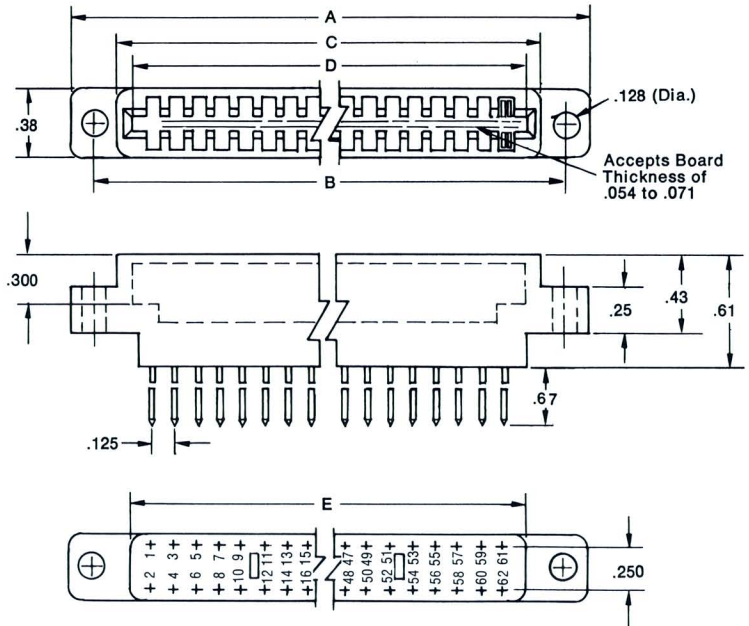

Housing Marking

No. of Dual Positions	Part Numbers			A	B	C	D	E
	Diallyl Phthalate Housing	Phenolic Housing						
	.000030 Selective Gold Plating	.000030 Selective Gold Plating	.000015 Selective Gold Plating					
15	67964-1	3-67964-0	67964-2	2.68	2.420	2.16	2.000	2.00
18	67964-3	3-67964-1	67964-4	3.06	2.795	2.54	2.375	2.38
22	67964-5	3-67964-2	67964-6	3.56	3.295	3.04	2.875	2.88
28	67964-7	3-67964-3	67964-8	4.30	4.045	3.78	3.625	3.62
30	67964-9	3-67964-4	1-67964-0	4.56	4.295	4.04	3.875	3.88
31	1-67964-1	3-67964-5	1-67964-2	4.68	4.420	4.16	4.000	4.00
35	1-67964-3	3-67964-6	1-67964-4	5.18	4.920	4.66	4.500	4.50
36	1-67964-5	3-67964-7	1-67964-6	5.30	5.045	4.78	4.625	4.62
40	1-67964-7	3-67964-8	1-67964-8	5.80	5.545	5.28	5.125	5.12
43	1-67964-9	3-67969-9	2-67964-0	6.18	5.920	5.66	5.500	5.50
50	2-67964-1	4-67964-0	2-67964-2	7.06	6.795	6.54	6.375	6.38
60	2-67964-3	4-67964-1	2-67964-4	8.30	8.045	7.78	7.625	7.62

Centerline Spacing: .125 x .200
 Post Size: .025" square equivalent *

Current Rating: 3 amps continuous

Housing Materials: Diallyl phthalate, type SDG-F (blue) or phenolic; type MFH (black) per MIL-M-14

Contact Material: Phosphor bronze per QQ-B-750

Contact Plating: .000005" min. gold over .000100" min. nickel — post area.

See table below for plating thickness on contact area.

Gold plating per MIL-G-45204, Type II, nickel plating per QQ-N-290.

Polarizing Key: Nylon material intercontact type, Part Number 67654-1. Contact replacement type 67372.

Replacement Contact: Part Number 67834-3.

Contact Replacement Tool: Part Number 265831-1.

* AMP's miniature post (.022" x .027") has the same cross section diagonal as the .025" sq. post and is approved by Gardner-Denver for hand, semi-automatic and automatic wrap-type applications using the .025" sq. termination technique.

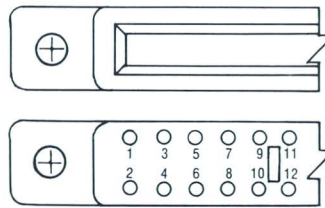
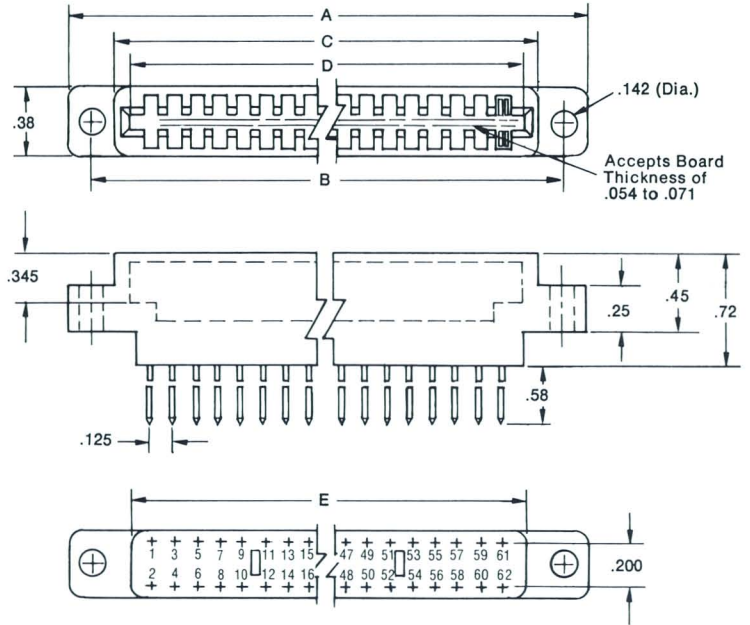

Housing Marking

No. of Dual Positions	Part Numbers			A	B	C	D	E
	Diallyl Phthalate Housing	Phenolic Housing						
	.000030 Selective Gold Plating	.000030 Selective Gold Plating	.000015 Selective Gold Plating					
12	67963-1	3-67963-0	67963-2	2.12	1.875	1.62	1.502	1.62
15	67963-3	3-67963-1	67963-4	2.50	2.250	2.00	1.877	2.00
18	67963-5	3-67963-2	67963-6	2.88	2.625	2.38	2.252	2.38
22	67963-7	3-67963-3	67963-8	3.38	3.125	2.88	2.752	2.88
28	67963-9	3-67963-4	1-67963-0	4.12	3.875	3.62	3.502	3.62
30	1-67963-1	3-67963-5	1-67963-2	4.38	4.125	3.88	3.752	3.88
31	1-67963-3	3-67963-6	1-67963-4	4.50	4.250	4.00	3.877	4.00
36	1-67963-5	3-67963-7	1-67963-6	5.12	4.875	4.62	4.502	4.62
40	1-67963-7	3-67963-8	1-67963-8	5.62	5.375	5.12	5.002	5.12
43	1-67963-9	3-67963-9	2-67963-0	6.00	5.750	5.50	5.377	5.50
50	2-67963-3	4-67963-0	2-67963-4	6.88	6.625	6.38	6.252	6.38

Centerline Spacing: .156 x .188
Post Size: .025" square equivalent *

Current Rating: 3 amps continuous

Housing Materials: Diallyl phthalate, type SDG-F (blue), phenolic; type MFH (black) per MIL-M-14, or polyester (green) per MIL-P-46161.

Contact Material: Phosphor bronze per QQ-B-750

Contact Plating: .000005" min. gold over .000100" min. nickel — post area. See tables below for plating thickness on contact area.

Gold plating per MIL-G-45204, Type II, nickel plating per QQ-N-290.

Polarizing Key: G-10 material intercontact type, Part Number 67611-6. Contact replacement type 67372

Replacement Contact: Part Number 67808-3.

Contact Replacement Tool: Part Number 265831-1

* AMP's miniature post (.022" x .027") has the same cross section diagonal as the .025" sq. post and is approved by Gardner-Denver for hand, semi-automatic and automatic wrap-type applications using the .025" sq. termination technique.

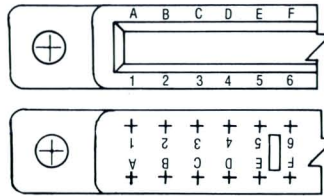
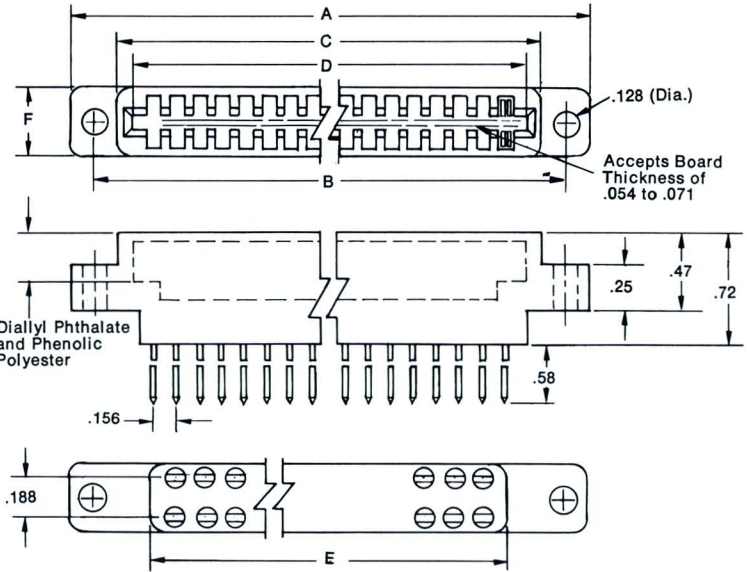

Marking for diallyl phthalate and phenolic housings.

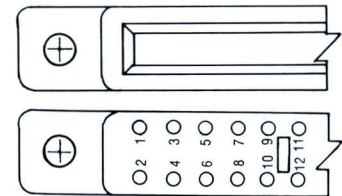

Marking for polyester housings.

No. of Dual Positions	Part Numbers			A	B	C	D	E	F
	Diallyl Phthalate Housing	Phenolic Housing							
	.000030 Selective Gold Plating	.000030 Selective Gold Plating	.000015 Selective Gold Plating						
10	67797-5	3-67797-0	67797-6	2.41	2.158	1.89	1.724	1.62	.35
15	67797-7	3-67797-1	67797-8	3.19	2.938	2.67	2.504	2.40	.35
18	2-67797-4	3-67797-2	67797-9	3.66	3.406	3.14	2.972	2.86	.35
22	1-67797-0	3-67797-3	1-67797-1	4.28	4.030	3.76	3.596	3.49	.35
25	1-67797-2	3-67797-4	1-67797-3	4.82	4.498	4.18	4.064	3.97	.44
28	1-67797-4	3-67797-5	1-67797-5	5.29	4.966	4.65	4.532	4.44	.44
30	1-67797-6	3-67797-6	1-67797-7	5.60	5.278	4.96	4.844	4.75	.44
32	1-67797-8	3-67797-7	1-67797-9	5.91	5.590	5.27	5.156	5.06	.44
36	2-67797-0	3-67797-8	2-67797-1	6.54	6.214	5.90	5.780	5.68	.44
43	2-67797-2	3-67797-9	2-67797-3	7.63	7.306	6.99	6.872	6.78	.44

No. of Dual Positions	Part Numbers		A	B	C	D	E	F
	Polyester Housings							
	.000030 Selective Gold Plating	.000015 Selective Gold Plating						
6	2-67985-1	67985-1	1.78	1.534	1.26	1.100	.99	.38
10	2-67985-2	67985-2	2.41	2.158	1.89	1.724	1.62	.38
15	2-67985-3	67985-3	3.19	2.938	2.67	2.504	2.40	.38
18	2-67985-4	67985-4	3.66	3.406	3.14	2.972	2.86	.38
22	2-67985-5	67985-5	4.28	4.030	3.76	3.596	3.49	.38
25	2-67985-6	67985-6	4.75	4.498	4.23	4.064	3.96	.38
28	2-67985-7	67985-7	5.22	4.966	4.70	4.532	4.42	.38
30	2-67985-8	67985-8	5.53	5.278	5.01	4.844	4.74	.38
32	2-67985-9	67985-9	5.84	5.590	5.32	5.156	5.05	.38
36	3-67985-0	1-67985-0	6.46	6.214	5.94	5.780	5.67	.38
43	3-67985-1	1-67985-1	7.56	7.306	7.04	6.872	6.76	.38

Centerline Spacing .156 x .188
Post Size: .031" x .062" *

Current Rating: 5 amps continuous

Housing Materials: Diallyl phthalate, type SDG-F (blue), phenolic; type MFH (black) per MIL-M-14, or polyester (green) per MIL-P-46161.

Contact Material: Phosphor bronze per QQ-B-750

Contact Plating: .000005" min. gold over .000100" min. nickel — post area.
 See tables below for plating thickness on contact area.

Gold plating per MIL-G-45204, Type II, nickel plating per QQ-N-290.

Polarizing Key: G-10 material intercontact type, Part Number 67611-6. Contact replacement type 67372

Replacement Contact: Part Number 7-67018-5.

Contact Replacement Tool: Part Number 265831-3

* These posts are approved by Gardner-Denver for hand and semi-automatic wrap type applications.

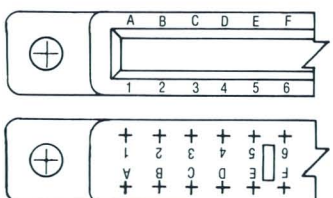
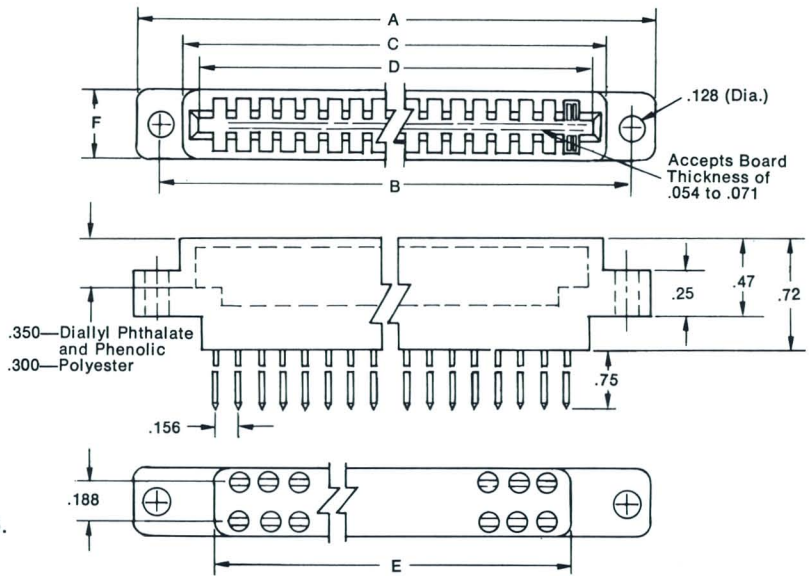

Marking for diallyl phthalate and phenolic housings.

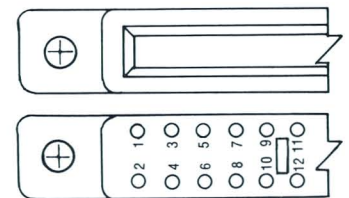

Marking for polyester housings.

No. of Dual Positions	Part Numbers			A	B	C	D	E	F
	Diallyl Phthalate Housing		Phenolic Housing						
	.000030 Selective Gold Plating	.000030 Selective Gold Plating	.000015 Selective Gold Plating						
10	67824-2	3-67824-0	1-67824-2	2.41	2.158	1.89	1.724	1.62	.35
15	67824-3	3-67824-1	1-67824-3	3.19	2.938	2.67	2.504	2.40	.35
18	67824-4	3-67824-2	1-67824-4	3.66	3.406	3.14	2.972	2.86	.35
22	67824-5	3-67824-3	1-67824-5	4.28	4.030	3.76	3.596	3.49	.35
25	67824-6	3-67824-4	1-67824-6	4.82	4.498	4.18	4.064	3.97	.44
28	67824-7	3-67824-5	1-67824-7	5.29	4.966	4.65	4.532	4.44	.44
30	67824-8	3-67824-6	1-67824-8	5.60	5.278	4.96	4.844	4.75	.44
32	67824-9	3-67824-7	1-67824-9	5.91	5.590	5.27	5.156	5.06	.44
36	1-67824-0	3-67824-8	2-67824-0	6.54	6.214	5.90	5.780	5.68	.44
43	1-67824-1	3-67824-9	2-67824-1	7.63	7.306	6.99	6.872	6.78	.44

No. of Dual Positions	Part Numbers		A	B	C	D	E	F
	Polyester Housings							
	.000030 Selective Gold Plating	.000015 Selective Gold Plating						
6	2-67986-1	67986-1	1.78	1.534	1.26	1.100	.99	.37
10	2-67986-2	67986-2	2.41	2.158	1.89	1.724	1.62	.37
15	2-67986-3	67986-3	3.19	2.938	2.67	2.504	2.40	.37
18	2-67986-4	67986-4	3.66	3.406	3.14	2.972	2.86	.37
22	2-67986-5	67986-5	4.28	4.030	3.76	3.596	3.49	.37
25	2-67986-6	67986-6	4.75	4.498	4.23	4.064	3.96	.37
28	2-67986-7	67986-7	5.22	4.966	4.70	4.532	4.42	.37
30	2-67986-8	67986-8	5.53	5.278	5.01	4.844	4.74	.37
32	2-67986-9	67986-9	5.84	5.590	5.32	5.156	5.05	.37
36	3-67986-0	1-67986-0	6.46	6.214	5.94	5.780	5.67	.37
43	3-67986-1	1-67986-1	7.56	7.306	7.04	6.872	6.76	.37

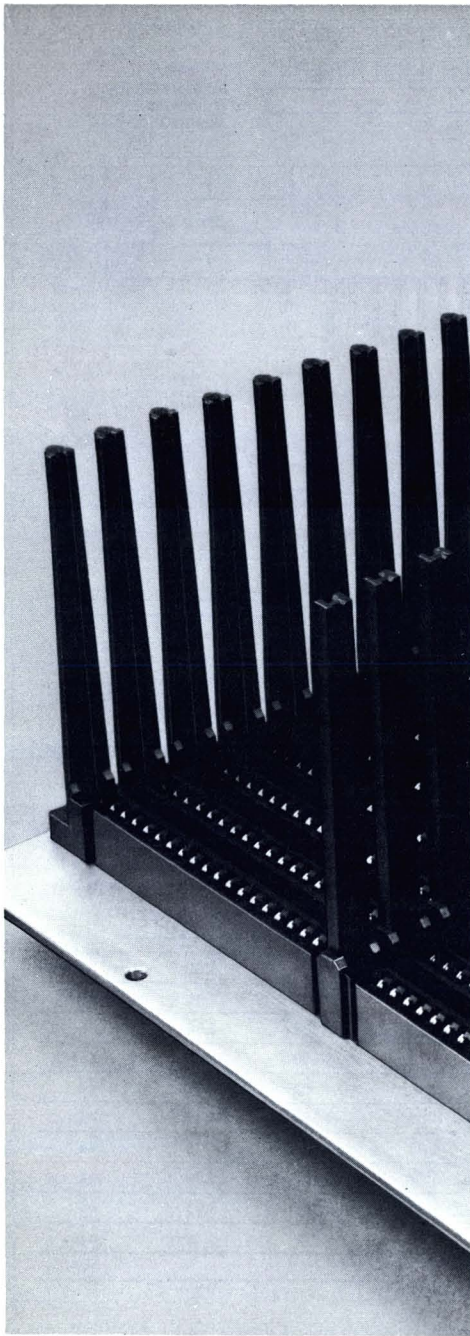

TERMI-PLATE Connector Assembly

A-MP★ TERMI-PLATE Connectors are one piece card-entry connectors designed to be mounted in an aluminum panel. For point to point wiring applications, these connectors can be arranged in a variety of panel assemblies and terminated automatically by the TERMI-POINT★ Automatic Machine.

The TERMI-PLATE Connectors are available with glass filled nylon housings and feature bifurcated contacts. The redundant characteristic of these contacts with the proven gold-over-nickel plating provides excellent electrical and mechanical performance.

Complete connector assemblies are available in a variety of sizes for accepting .022" x .036" and .031" x .062" TERMI-POINT clip terminations. Connectors to be terminated with .022" x .036" TERMI-POINT clips are supplied in sizes of 18 and 44 dual contact positions on .150" x .150" centers. For .031" x .062" TERMI-POINT clip terminations, a 21 dual position connector is available with contacts on .200" x .200" centers. AMP's production capabilities for this connector, however, can be readily expanded to include a range of connectors up to 36 dual positions, upon request.

The TERMI-PLATE connectors when mounted on a .125" aluminum panel form an integral part of the wiring system. The pre-drilled plate acts as a fixture which holds the connectors in the desired pattern for automatic wiring. Each connector has insulating silos around each post, except those posts to be grounded to the plate. Small metal bushings are provided for grounding the post to panel connection.

Features

- Bifurcated contacts with selective gold-over nickel plating for excellent electrical conductivity.
- Available on .150" or .200" centers.
- Compatible with TERMI-POINT clip, solder, weld or wrap-type wiring.
- Closed card entry prevents over-stressing of contacts.
- Accommodates wire range – 28 to 30 AWG for .022" x .036" posts, 22 to 28 AWG for .031" x .062" post.
- Pre-determined grounding positions.
- Intercontact keying.
- Separate Card Guides
- Glass-filled nylon housings available in 18, 21 and 44 dual positions — other configurations available upon request.

Card guides for the 21 dual position connector are available to facilitate pc board plug-in. These guides — an end version and a center version — can be installed after panel wiring is completed. By the use of two end guides and one center guide, two 21 position pc boards can be plugged into the connectors. However, if one large 42 position board is to be used, simply omit the center guide.

All A-MP TERMI-PLATE connectors are designed to accept pc boards per MIL-STD-275 and to meet the requirements of AMP Product Specifications GPS 505-1 and GPS 505-2. The operating parameters of these connectors include:

Operating Temperature – 55°C to +105°C (continuous)
Contact Engaging and Separation Force—2 oz. (min.) to 16 oz. (max.)

Contact Rating:

For .031" x .062" Contacts—5 amps
For .022" x .036" Contacts—3 amps

Test results for TERMI-PLATE connectors with .031" x .062" posts are outlined in AMP Test Report GPR 575-28. Testing categories included in this report are: insulation resistance, dielectric withstanding voltage, contact resistance, contact engaging and separation force, and temperature cycling. Copies of this Test Report (GPR 575-28) and of AMP Product Specifications GPS 505-1 and GPS 505-2 are available upon request.

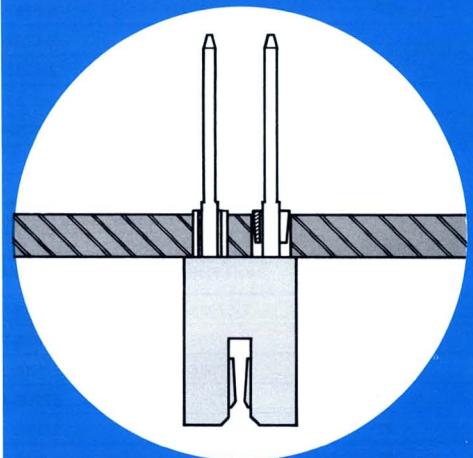

Specifications

.031" x .062" Posts
Accommodates 3 TERMI-POINT Clips

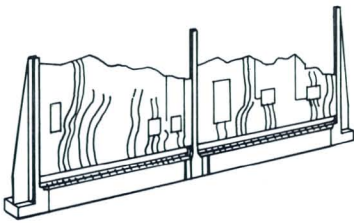

2-21 Position Board Applications

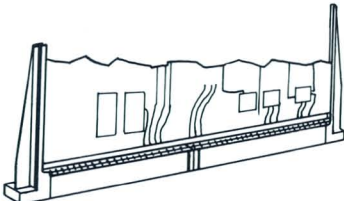

1-42 Position Board Application

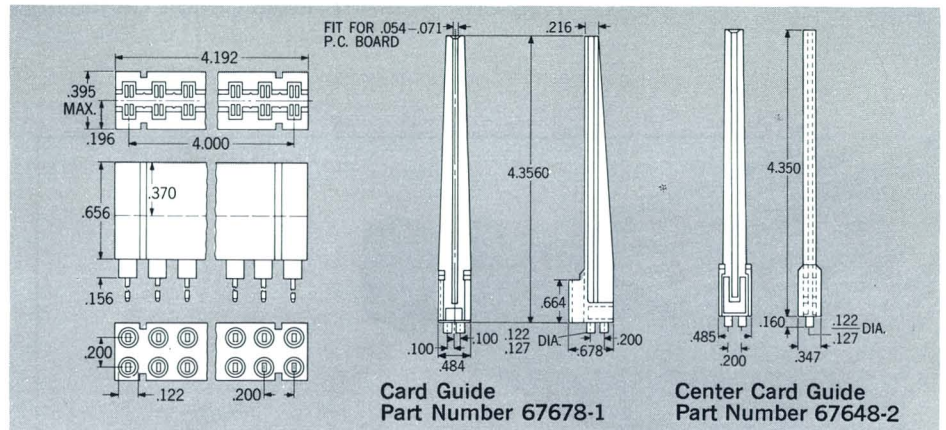

Card Guide
Part Number 67678-1

Center Card Guide
Part Number 67648-2

21 Position Connector — Part Number 67649-1*
Accepts printed circuit board thickness of .054" to .071"

Housing Material: Glass filled nylon

Contact Material: Phosphor bronze, gold flash over .000050 nickel except on contact area which is .000030 gold

Inter-contact keying plug (barrier type) Part Number 1-67611-0

*Other connector configurations available, contact AMP Incorporated

.022" x .036" Posts
Accommodates 3 TERMI-POINT Clips

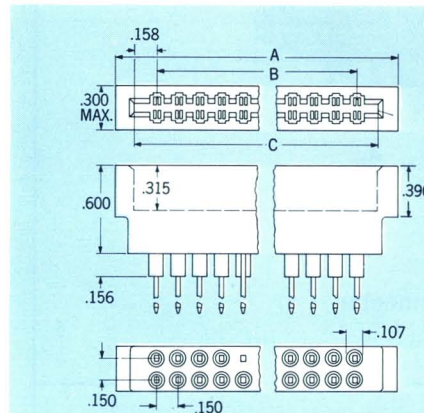

Accepts Printed Circuit board thickness of .054" to .071"

Housing Material:
Glass filled nylon

Contact Material:
Phosphor bronze, gold flash over .000050 nickel except on contact area which is .000030 gold

No. of Dual Positions *	Part Number	DIMENSIONS		
		A	B	C
18	67769-1	3.028	2.550	2.866
44	67766-1	6.928	6.450	6.766

Inter-contact keying plug (barrier type) Part Number 67654-1

*Other connector configurations available, contact AMP Incorporated

Ground Bushing



Post Size	Material	Part No.	Insertion Tool No.
.022" x .036"	Brass	67118	69565-2
	Tin Plated Brass	67118-1	
.031" x .062"	Brass	67118-2	69565
	Tin Plated Brass	67118-3	

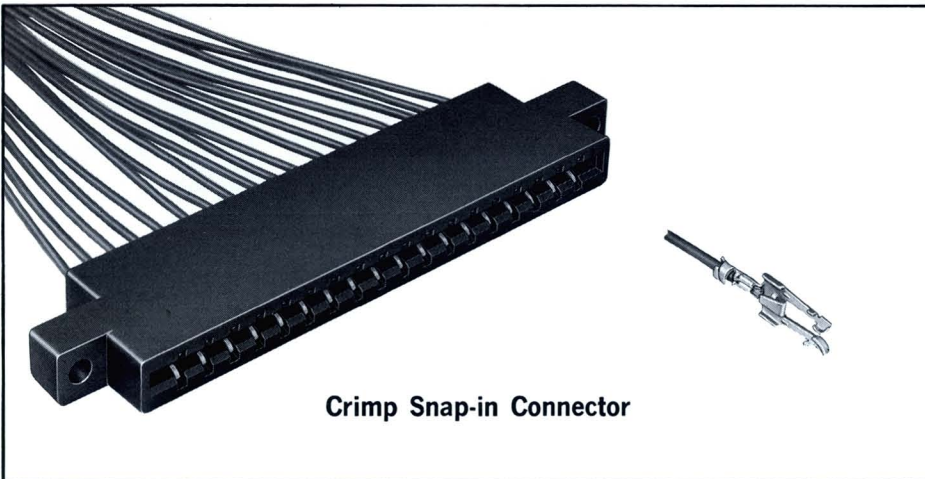

Crimp Snap-in Connector

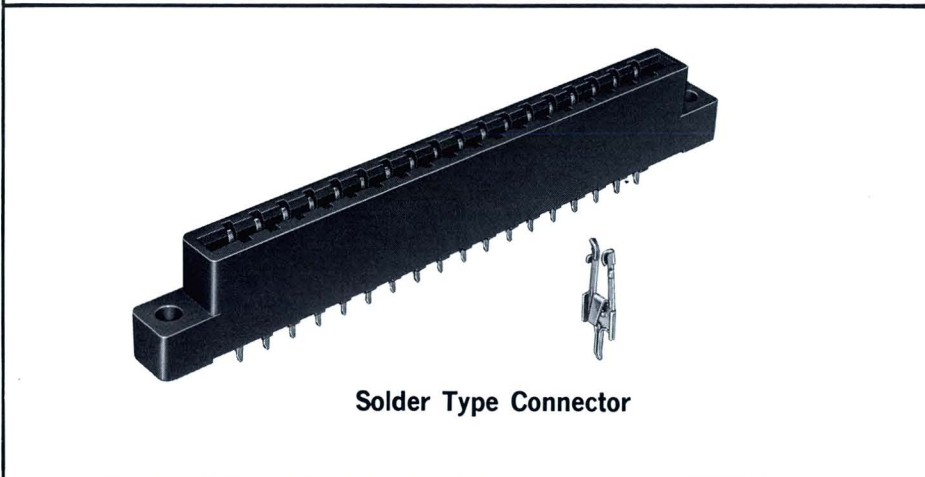

Solder Type Connector

The AMP* Modified Fork Printed Circuit Connector is available for board-to-wire and board-to-board applications. Reliability and economy are the industry preferred features of this line of connectors.

The board-to-wire connectors provide low per line costs by combining automatic crimp termination of contacts and the use of selective plating in critical contact areas.

The board-to-board connector offers the same selective plating in the contact areas and is available with preloaded contacts. The "U" channel contact tails fit .052" diameter hole and provide excellent wicking for flow soldering.

Both the board-to-wire and board-to-board connectors assure reliability through superior contact tolerance of environmental stresses, including thermal shock, vibration, humidity

and temperature variations. Other parameters such as insulation resistance, dielectric strength, contact retention and engagement and separation forces meet all industry requirements for reliability.

Housings are available in sizes 3 to 33 position. Crimp, snap-in contact connectors are a high profile design providing eggcrating for electrical and mechanical protection of contacts. Made of a U.L. Inc. recognized self-extinguishing material, these housings accept a full range of .062" thick cards and are available with contacts on .156" centers.

Crimp, snap-in contacts for the board-to-wire connectors are available in reel fed, strip form for AMP-O-LECTRIC* or AMPOMATOR* Automatic Machine Application. CERTI-CRIMP* hand tools are available for prototype or limited production.

Modified Fork Printed Circuit Connectors

FEATURES

- Low applied cost by automatic machine termination
- Choice of overall tin plating or gold over nickel on critical contact areas when increased reliability is desired
- Smooth contoured contact surfaces for positive contact
- Contact design reduces board wear and increases contact durability
- Built-in anti-overstress for the locking latch
- Contact self aligning upon insertion due to unique "fork" design
- Contact keying available for both on-contact and intercontact modes
- Four connector styles utilizing solder type contacts
- Bold cavity identification
- Contacts accept wire range 18 to 26 AWG for board-to-wire applications
- "U" Shaped tails on board-to-board connectors facilitate flow solder
- Accepts printed board .054-.070 thick
- Contact on .156 centers
- Contacts have 5 amp capacity
- Operating temperature: -55°C to +105°C
- Replaceable crimp snap-in contacts

Housings

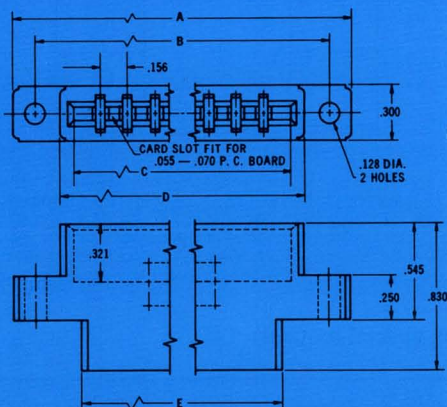

Housings
(Offset Card Slot)

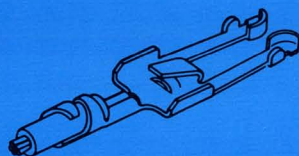
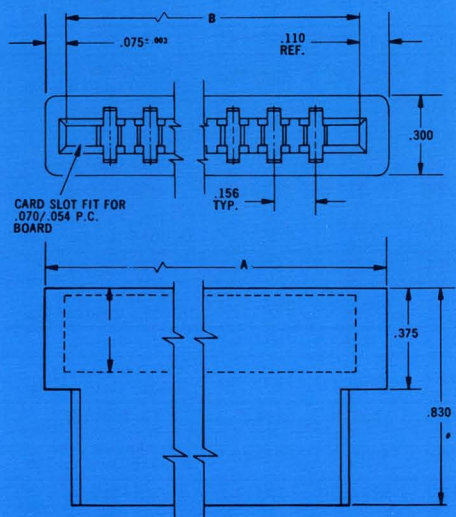

Material: Glass Filled Nylon, Brown

No. of Positions	A	B	C	D	E	Part No.
3	1.314	1.066	.632	.774	.532	583296-1
6	1.782	1.534	1.100	1.242	1.000	583297-1
9	2.250	2.002	1.568	1.710	1.468	583298-1
10	2.406	2.158	1.724	1.866	1.624	583299-1
12	2.718	2.470	2.036	2.178	1.936	583300-1
15	3.186	2.938	2.504	2.646	2.404	583301-1
18	3.654	3.406	2.972	3.114	2.872	583302-1
22	4.278	4.030	3.596	3.738	3.496	583282-1
24	4.590	4.342	3.908	4.050	3.808	583303-1
33	5.994	5.746	5.312	5.454	5.212	583304-1

Material: Glass Filled Nylon, Brown

No. of Positions	A	B	Part No.
3	.830	.632	583368-1
4	.986	.788	583456-1
6	1.298	1.100	583369-1
7	1.454	1.256	583566-1
8	1.610	1.412	583693-1
9	1.766	1.568	583370-1
10	1.922	1.724	583479-1
12	2.234	2.036	583371-1
15	2.702	2.504	583576-1
22	3.794	3.596	583791-1
24	4.106	3.908	583730-1
33	5.510	5.312	583791-3

Wire Size	Insulation Range	Finish	Part No.		Hand Tool
			Strip Form	Loose Piece	
18-20	.110 to .070	Tin Plated	583362-2	583363-1	90215-1
		.000015 Gold on Tip*	583362-3	583363-2	
		.000030 Gold on Tip*	583362-4	583363-3	
20-24	.090 to .050	Tin Plated	583259-2	583261-1	90215 90253-1
		.000015 Gold on Tip*	583259-3	583261-2	
		.000030 Gold on Tip*	583259-4	583261-3	
24-26	.045 to .038	Tin Plated	583497-2	583498-1	90253-1
		.000015 Gold on Tip*	583497-3	583498-2	
		.000030 Gold on Tip*	583497-4	583498-3	

*Nickel all over
Extraction Tool No. 91037-2
Contact Keying Plug (Nylon) Part No. 583283-1 (on contact)
Contact Keying Plug (Nylon) Part No. 583462-1 (inter-contact)

Solder Type Connectors (Pre-loaded Contacts)

Housing Assemblies

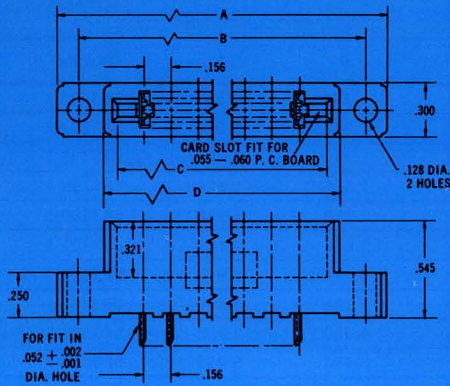

SOLDER DIP

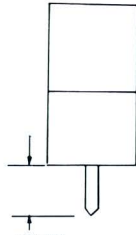

TYPE I

OFFSET SOLDER DIP



TYPE II

STAGGERED GRID SOLDER DIP

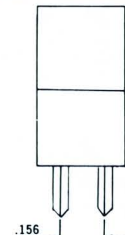

TYPE III

SOLDER TAB

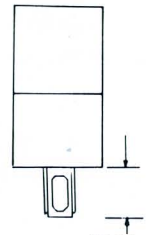

TYPE IV

Material: Glass Filled Nylon, Brown
Contact Material: Phosphor Bronze
 (Selectively Loaded Housings available upon special request)

No. of Pos.	A	B	C	D	Part No.				Contact Plating
					Type I	Type II	Type III	Type IV	
3	1.314	1.066	.632	.774	583347-1	583792-1	583793-1	583413-2	Tin Plating
					583347-2	583792-2	583793-2	583413-1	Nickel all over .000015 Gold on Tip
6	1.782	1.534	1.100	1.242	583351-1	583792-3	583793-3	583415-2	Tin Plating
					583351-2	583792-4	583366-1	583415-1	Nickel all over .000015 Gold on Tip
7	1.938	1.690	1.256	1.398	583794-1	583792-5	583793-4	583794-3	Tin Plating
					583794-2	583792-6	583543-1	583794-4	Nickel all over .000015 Gold on Tip
9	2.250	2.002	1.568	1.710	583352-1	583792-7	583793-5	583416-2	Tin Plating
					583352-2	583792-8	583582-1	583416-1	Nickel all over .000015 Gold on Tip
10	2.406	2.158	1.724	1.866	583353-1	583792-9	583793-6	583417-2	Tin Plating
					583353-2	1-583792-0	583387-1	583417-1	Nickel all over .000015 Gold on Tip
12	2.718	2.470	2.036	2.178	583354-1	1-583792-1	583793-7	583418-2	Tin Plating
					583354-2	1-583792-2	583793-8	583418-1	Nickel all over .000015 Gold on Tip
15	3.186	2.938	2.504	2.646	583355-1	1-583792-3	583793-9	583419-2	Tin Plating
					583355-2	1-583792-4	583386-1	583419-1	Nickel all over .000015 Gold on Tip
18	3.654	3.406	2.972	3.114	583356-1	1-583792-5	1-583793-0	583420-2	Tin Plating
					583356-2	1-583792-6	583365-1	583420-1	Nickel all over .000015 Gold on Tip
22	4.278	4.030	3.596	3.738	583357-1	1-583792-7	1-583793-1	583421-2	Tin Plating
					583357-2	1-583792-8	583467-1	583421-1	Nickel all over .000015 Gold on Tip
24	4.590	4.342	3.908	4.050	583358-1	1-583792-9	1-583793-2	583422-2	Tin Plating
					583358-2	2-583792-0	1-583793-3	583422-1	Nickel all over .000015 Gold on Tip
33	5.994	5.746	5.312	5.454	583359-1	2-583792-1	1-583793-4	583423-2	Tin Plating
					583359-2	2-583792-2	1-583793-4	583423-1	Nickel all over .000015 Gold on Tip

Card Guide

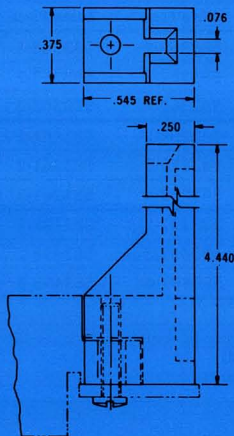

Card Guide Material: Glass Filled Nylon, Brown
Part Number: 583760-1

Printed Circuit Connectors

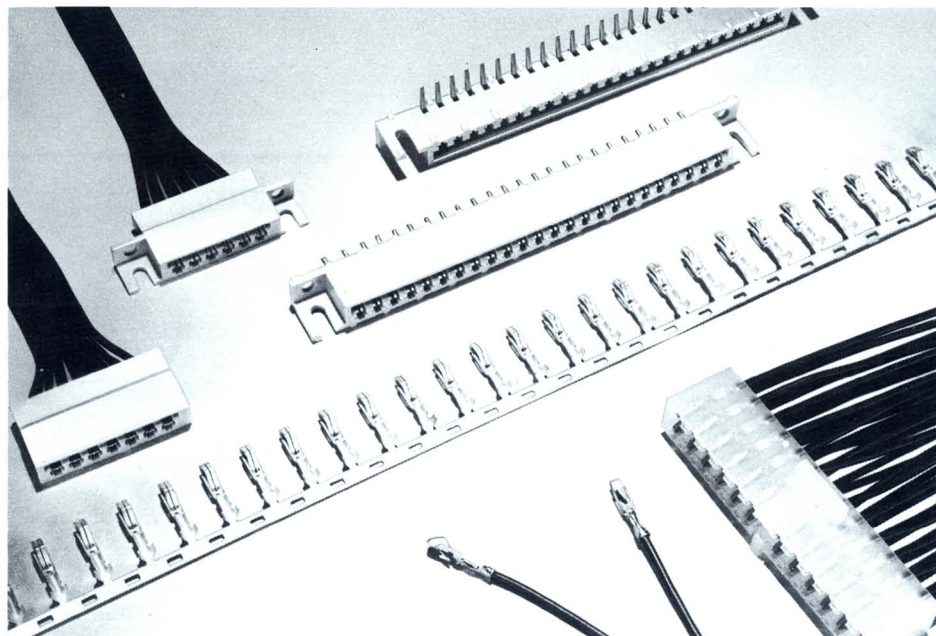

AMP's printed circuit edge connectors with bifurcated leaf-type contacts are designed for applications demanding the highest levels of conductivity and reliability. They are U.L. recognized flame retardant connectors and meet all industry requirements for low cost top performance connections to .062" thick single- and double-sided pc boards.

For optimum versatility, AMP offers these connectors in numerous styles and sizes. Included are: board-to-wire connectors which accept 2 to 24 crimp snap-in contacts for single-sided boards; a 12-position (dual contact board-to-wire version which accepts 24 crimp snap-in contacts for double-sided boards and is self-locking for positive board retention; and 6 thru 24-circuit board-to-board connectors that have preloaded contacts with solder tabs for horizontal and 90° single sided mother/daughter board packaging.

Reliability and economy are realized through many built-in design features. Contacts are stamped and formed from high conductivity brass, phosphor bronze or beryllium copper and are plated either tin or gold for long life and excellent resistance to corrosion. Their leaf-type design assures a firm wiping action with pc board pads to establish intimate electrical

contact, while the bifurcated design achieves contact redundancy. These features combine to maintain the electrical and mechanical integrity of the board connections.

All crimp snap-in contacts are easily inserted into the connector housings — no tooling required — and are just as easily removed with a simple extraction tool. They accept a wire size range of #30 to #18 AWG and insulation diameters to .100". AMP supplies these contacts in strip form for automatic machine application. AMP high-speed machines are precision-engineered to provide maximum production rates, reduce waste and assure consistently uniform top-quality terminations. Loose piece contacts and hand tools are available for prototypes and repair.

Other design features which add to the reliability and versatility of this AMP connector family are: housings with a closed card-entry design to prevent overstressing of contacts; plus board-to-wire connectors which are available with and without mounting ears and which will accept AMP on-contact keying plugs for pc board keying use as well as locking plugs that provide a means to positively lock the connector to a board.

Bifurcated Leaf-Type Contact Connectors

Features

- Bifurcated leaf-type contacts provide firm wiping action for positive electrical continuity with redundant points of contact.
- Connectors accommodate full range of .062^{±.007} thick pc boards.
- Wide selection of styles and sizes available: board-to-wire connectors for single-sided boards — in 2 to 24 circuit sizes, contacts on .156" centers; a self-locking board-to-wire version for double-sided boards — in a dual contact (12-position) arrangement, contacts on .188" centers; and board-to-board connectors for single-sided boards — in 6 thru 24 circuit sizes, preloaded contacts with straight or 90° solder tabs on .156" centers.
- 94V-0 polyester thermoplastic unreinforced material.
- Contacts available in brass, phosphor bronze and beryllium copper and with tin or gold plating.
- Crimp snap-in contacts accept #30-18 AWG wire and insulation diameters to .100".
- Individual contacts require no tooling for loading into housings, and are removable for circuit change or repair.
- High-speed automatic machine termination assures reliability at a low applied cost.
- Recognized under the Component Program of Underwriters' Laboratories, Incorporated (File No. E-28476).



Performance Parameters

Contacts are rated at 3 amperes #26 wire and 5 amperes #18 wire, 30°C rise.
 Housings — 120°C flame retardant to UL 94V-0.
 Termination Resistance — 10 milliohms max.
 Vibration — MIL-STD-202, Method 201, 10-55-10 CPS.
 Salt Spray — MIL-STD-202, Method 101, 48 hrs. 5% salt solution.
 Current Cycling — 50 cycles @ 125% rated current.

Refer to AMP Product Specification 108-1020 for further details.

Board-to-Wire Connectors

2 to 24 Circuit Housings (for single-sided boards)

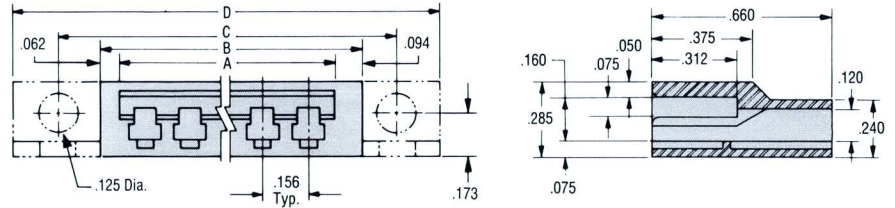

Material: Unreinforced polyester thermoplastic, 94V-0 Rated; Color, Natural

No. of Circuits (Contacts)	Dimensions				Part Number	
	A	B	C	D	With Mounting Ears	Without Mounting Ears
2	.344	.500	.766	1.078	640137-2	640136-2
3	.500	.656	.922	1.234	640137-3	640136-3
4	.656	.812	1.078	1.390	640137-4	640136-4
5	.813	.969	1.235	1.547	640137-5	640136-5
6	.969	1.125	1.391	1.703	640137-6	640136-6
7	1.125	1.281	1.547	1.859	640137-7	640136-7
8	1.281	1.437	1.703	2.015	640137-8	640136-8
9	1.438	1.594	1.860	2.172	640137-9	640136-9
10	1.594	1.750	2.016	2.328	1-640137-0	1-640136-0
11	1.750	1.906	2.172	2.484	1-640137-1	1-640136-1
12	1.906	2.062	2.328	2.640	1-640137-2	1-640136-2
13	2.063	2.219	2.485	2.797	1-640137-3	1-640136-3
14	2.219	2.375	2.641	2.953	1-640137-4	1-640136-4
15	2.375	2.531	2.797	3.109	1-640137-5	1-640136-5
16	2.531	2.687	2.953	3.265	1-640137-6	1-640136-6
17	2.688	2.844	3.110	3.422	1-640137-7	1-640136-7
18	2.844	3.000	3.266	3.578	1-640137-8	1-640136-8
19	3.000	3.156	3.422	3.734	1-640137-9	1-640136-9
20	3.156	3.312	3.578	3.890	2-640137-0	2-640136-0
21	3.313	3.469	3.735	4.047	2-640137-1	2-640136-1
22	3.469	3.625	3.891	4.203	2-640137-2	2-640136-2
23	3.625	3.781	4.047	4.359	2-640137-3	2-640136-3
24	3.781	3.937	4.203	4.515	2-640137-4	2-640136-4

Notes:

1. All housings will accept keying plugs 1-480600-0 and 640180-1.
2. For locking plug data, see following page.

**Recommended
pc Board Layout
(board thickness:
.062^{±.007})**

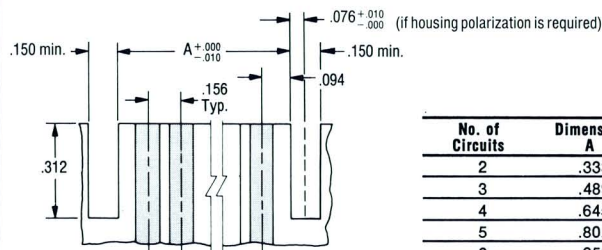

Circuitry Side

Recommended .015 min. x 45° chamfer both sides of pc board

Circuit Path Width — .090 Min.

No. of Circuits	Dimension A	No. of Circuits	Dimension A
2	.333	14	2.208
3	.489	15	2.364
4	.645	16	2.520
5	.802	17	2.677
6	.958	18	2.833
7	1.114	19	2.989
8	1.270	20	3.145
9	1.427	21	3.302
10	1.583	22	3.458
11	1.739	23	3.614
12	1.895	24	3.770
13	2.052		

Specifications subject to change without notice. For latest design drawings contact AMP Incorporated. All dimensions in inches.

Board-to-Wire Connectors

On-Contact Keying Plugs

Keying plugs snap into housings

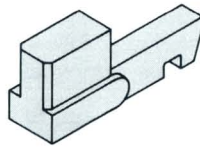

Material: Type 6/6 Natural Nylon
Part No. 640180-1

(Locks on ledge within housing)

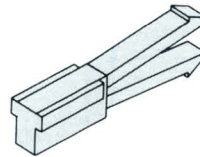

Material: Type 6/6 Natural Nylon
Part No. 1-480600-0

(Positive lock type — locks on rear of housing)

Recommended Board Cutout

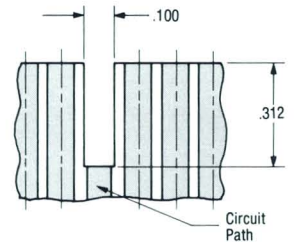

Double Circuit Locking Plug

Recommended pc board layout for Double Circuit Locking Plug (two circuit cavities required)

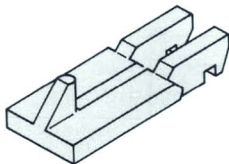

Material: Type 6/6 Nylon; Color, Natural
Part No. 350555-1

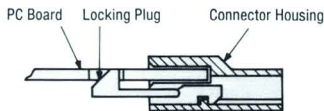

Detail of Installed Plug — snaps into housing

Note: Two circuit cavities required per locking plug.

Single Circuit Locking Plug

Recommended pc board layout for Single Circuit Locking Plug (one circuit cavity required)

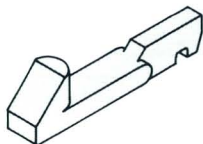

Material: Type 6/6 Nylon; Color, Natural
Part No. 640179-1

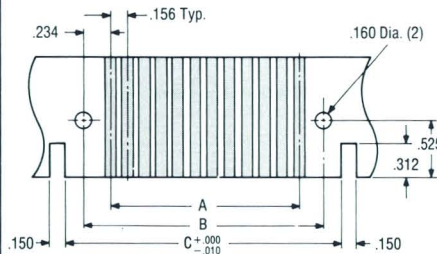

Circuit Path Width — .090 Min.

Style A — Pc Board Double Locking Feature

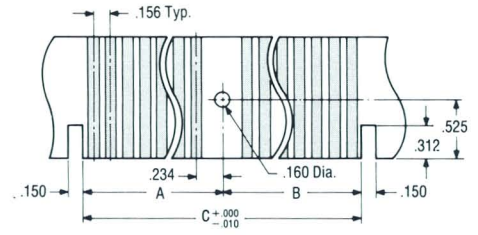

Style B — Pc Board Single Locking Feature

No. of Circuits		Dimensions		
Total	Active	A	B	C
12	8	1.092	1.560	1.895
13	9	1.248	1.716	2.052
14	10	1.404	1.872	2.208
15	11	1.560	2.028	2.364
16	12	1.716	2.184	2.520
17	13	1.872	2.340	2.677
18	14	2.028	2.496	2.833
19	15	2.184	2.652	2.989
20	16	2.340	2.808	3.145
21	17	2.496	2.964	3.302
22	18	2.652	3.120	3.458
23	19	2.808	3.276	3.614
24	20	2.964	3.432	3.770

No. of Circuits		Dimensions		
Total	Active	A	B	C
7	5	.635	.479	1.114
8	6	.635	.635	1.270
9	7	.792	.635	1.427
10	8	.792	.791	1.583
11	9	.948	.791	1.739
12	10	.948	.947	1.895
13	11	1.105	.947	2.052
14	12	1.105	1.103	2.208
15	13	1.261	1.103	2.364
16	14	1.261	1.260	2.520
17	15	1.417	1.260	2.677
18	16	1.417	1.416	2.833
19	17	1.573	1.416	2.989
20	18	1.573	1.572	3.145
21	19	1.730	1.572	3.302
22	20	1.730	1.728	3.458
23	21	1.886	1.728	3.614
24	22	1.886	1.884	3.770

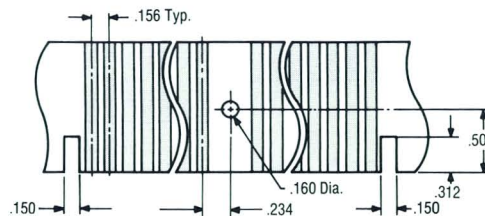

Board-to-Wire Connectors

12 Position (Dual Contact) Housing with Locking Lance (for double-sided boards)

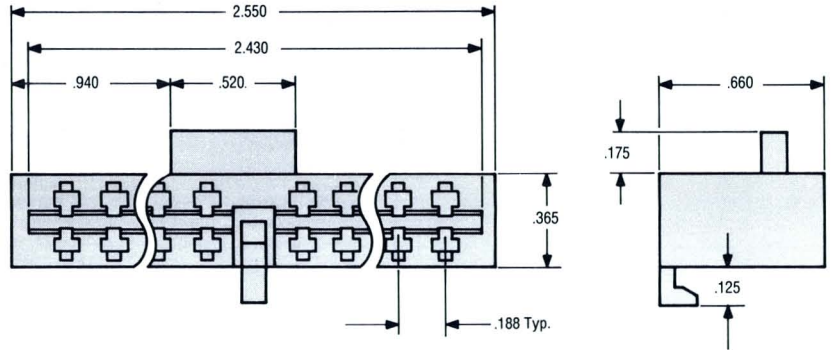

Material: 6/6 Type Natural Nylon (94V-2 Rated)
Part No. 1-480651-0
Note: Recommended contact Part No. 61668

Recommended pc Board Layout (same circuitry both sides) (board thickness: .062^{±.007})

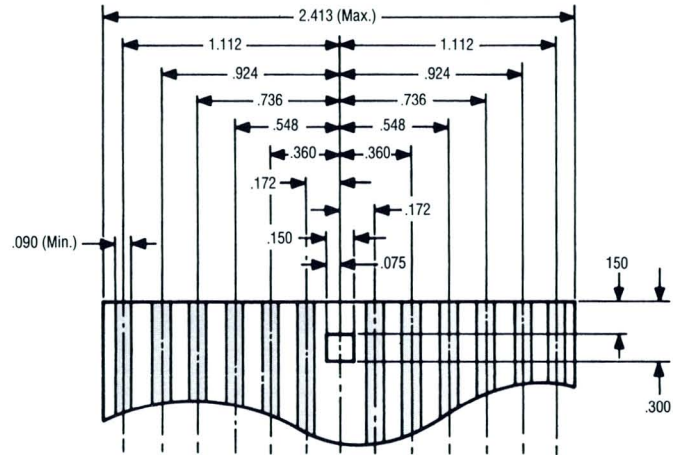

Contacts

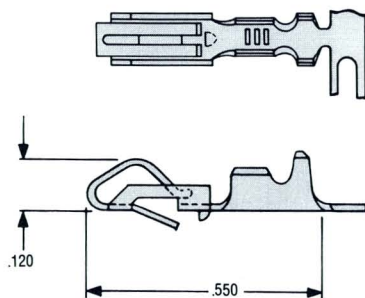

Wire Size	Ins. Dia.	Material	Stock Thickness	Finish	Loose Piece Part No.	Strip Form Part No.
24-18	.100 Max.	Brass	.012	Tin Plated	350011-1	61668-1 61668-6 ^o
		Phosphor Bronze	.012	Pre-Tinned	350011-3	61668-2
		Phosphor Bronze	.012	Selective Gold Plated	350011-2	61668-4 1-61668-1 ^o
		Beryllium Copper	.012	Tin Plated	350011-4	61668-5 1-61668-0 ^o
		Beryllium Copper	.010	Pre-Tinned	—	350194-1 ^o **
		Brass	.010	Pre-Tinned	—	350194-2 ^o ** 350194-3 ^o
30-24	.040-.057	Brass	.010	Selective Gold Plated	—	350194-4 ^o
		Brass	.012	Tin Plated	—	640020-1

*Contacts reeled for termination in standard applicator. All others are reeled for termination in miniature applicator.

**Contacts with a stock thickness of .010 are recommended for housings having 12 or more circuits.

Hand Tool Part No. 90123-2 for loose piece contacts.

Extraction Tool Part No. 457241-1

Board-to-Board Connectors

**6 to 24 Circuit Assemblies
(for single-sided boards)**

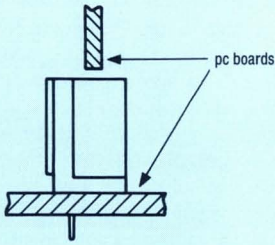

Style A Mounting

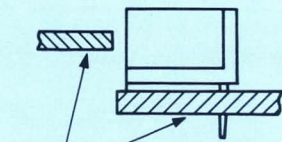

Style B Mounting

Style A Solder Tabs — for vertical mounting to pc board.

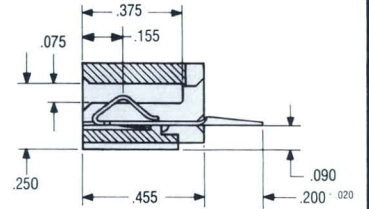
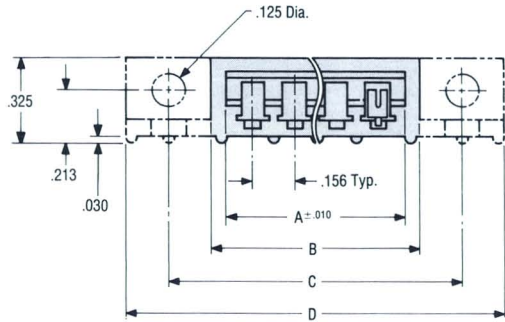

Style B Solder Tabs — for horizontal mounting to pc board.

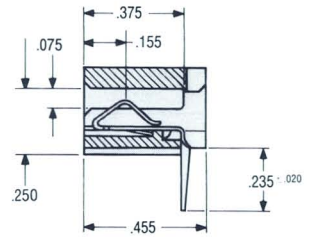
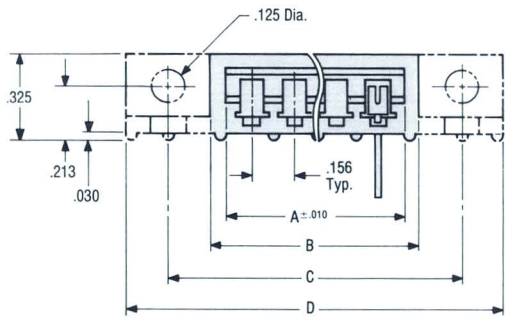

Materials:

- Housing** — Unreinforced polyester thermoplastic, 94V-0; Color Natural
- Contacts** — .010 Brass, Pre-tinned

No. of Circuits	Dimensions				Part Numbers			
	A	B	C	D	Style A Solder Tabs		Style B Solder Tabs	
					With Mounting Ears	Without Mounting Ears	With Mounting Ears	Without Mounting Ears
6	.969	1.077	1.389	1.701	640140-6	640133-6	640141-6	640134-6
7	1.125	1.233	1.545	1.857	640140-7	640133-7	640141-7	640134-7
8	1.281	1.389	1.701	2.013	640140-8	640133-8	640141-8	640134-8
9	1.438	1.546	1.858	2.170	640140-9	640133-9	640141-9	640134-9
10	1.594	1.702	2.014	2.326	1-640140-0	1-640133-0	1-640141-0	1-640134-0
11	1.750	1.858	2.170	2.482	1-640140-1	1-640133-1	1-640141-1	1-640134-1
12	1.906	2.014	2.326	2.638	1-640140-2	1-640133-2	1-640141-2	1-640134-2
13	2.063	2.171	2.483	2.795	1-640140-3	1-640133-3	1-640141-3	1-640134-3
14	2.219	2.327	2.639	2.951	1-640140-4	1-640133-4	1-640141-4	1-640134-4
15	2.375	2.483	2.795	3.107	1-640140-5	1-640133-5	1-640141-5	1-640134-5
16	2.531	2.639	2.951	3.263	1-640140-6	1-640133-6	1-640141-6	1-640134-6
17	2.688	2.796	3.108	3.420	1-640140-7	1-640133-7	1-640141-7	1-640134-7
18	2.844	2.952	3.264	3.576	1-640140-8	1-640133-8	1-640141-8	1-640134-8
19	3.000	3.108	3.420	3.732	1-640140-9	1-640133-9	1-640141-9	1-640134-9
20	3.156	3.264	3.576	3.888	2-640140-0	2-640133-0	2-640141-0	2-640134-0
21	3.313	3.421	3.733	4.045	2-640140-1	2-640133-1	2-640141-1	2-640134-1
22	3.469	3.577	3.889	4.201	2-640140-2	2-640133-2	2-640141-2	2-640134-2
23	3.625	3.733	4.045	4.357	2-640140-3	2-640133-3	2-640141-3	2-640134-3
24	3.781	3.889	4.201	4.513	2-640140-4	2-640133-4	2-640141-4	2-640134-4

Notes:

1. These edge connectors accept .062^{±.007} thick single-sided pc boards.
2. Both Style A and Style B solder tabs fit .062^{±.005} diameter board holes.
3. Recommended .015 x 45° chamfer both sides of pc boards.

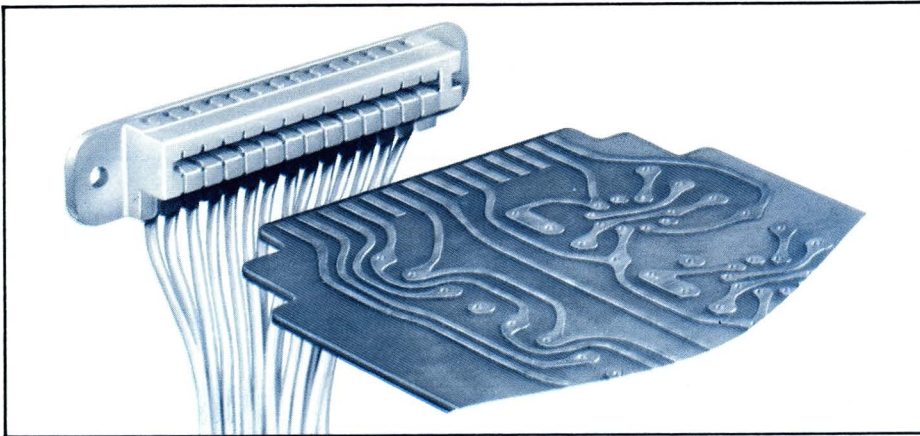

DUO-TYNE Flag One Piece Edge-Connectors

Product Specifications

This flag-type connector is designed to meet the quality and reliability requirements of such equipment as appliance controls, vending machine sub-assemblies, television, stereo, business machines and other applications with similar control needs. Among its assembly-saving features is a right angle design which permits cabling in close quarters, where it does not require frame mounting to attach the keyed housing to the card cutout. In addition, contacts are recessed to prevent arcing. All sizes and configurations are available with or without mounting ears. Added to low initial cost, lowest installed costs are achieved through high-speed compression crimping with AMP matched tooling.

Product Specifications

Contact rating: 5 Amps.
Housing material: Nylon
Operating temperature:
-40°C to +105°C.
Contact material: Phosphor Bronze or Beryllium Copper.
Contact plating: Tin plated or gold plated.
High potential: 2200 (VAC RMS)
Vibration: 10 to 55 cps per method 201 of MIL-STD-202.
AMP product specification numbers:
For standard beam contacts — 108-9016; for tapered beam contacts — 108-9038.

Contact Plating Code

1.000030 Gold over .000050 Nickel
2.000015 Gold over .000030 Nickel-Contact Area
.000030 Nickel Remainder at Contact

Specifications subject to change without notice. For latest design drawings contact AMP Incorporated. All dimensions in inches.

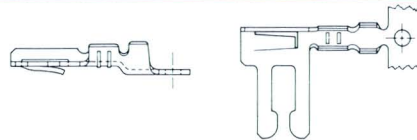

Standard Contact

Wire Range	Insulation Range	Material	Finish	Part Number			Hand Tool Part Number
				Strip Form (For Standard Applicator)	Strip Form (For Miniature Applicator)	Loose Piece	
18-16	.090-.130	Phosphor Bronze	Tin Plate	530501-2	530501-5	530502-1	90335-1
			Gold over Nickel ¹	530501-3	530501-6	530502-2	
			Selective Gold ²	530501-4	530501-7	530502-3	
		Beryllium Copper	Tin Plate	530503-2	530503-5	530504-1	
			Gold over Nickel ¹	530503-3	530503-6	530504-2	
			Selective Gold ²	530503-4	530503-7	530504-3	
22-18	.060-.090	Phosphor Bronze	Tin Plate	60215-4	66335-2	66088-2	90027
			Gold over Nickel ¹	60215-5	66335-3	66088-3	
			Selective Gold ²	—	66335-4	—	
		Beryllium Copper	Tin Plate	583284-2	—	583285-2	
			Gold over Nickel ¹	—	—	—	
			Selective Gold ²	583284-4	583284-5	583285-4	
26-22	.035-.055	Phosphor Bronze	Tin Plate	66149-4	66362-1	66150-2	90094
			Gold over Nickel ¹	66149-3	66362-2	66150-3	
			Selective Gold ²	—	66362-3	—	
		Beryllium Copper	Tin Plate	583379-2	583379-7	583380-2	
			Gold over Nickel ¹	583379-5	583379-6	583380-4	
			Selective Gold ²	583379-3	583379-4	583380-3	

Contact Extraction Tool Part No. 810992-1

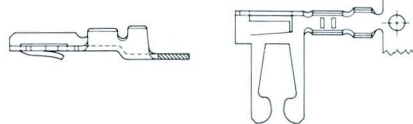

Tapered Beam Contact

Wire Range	Insulation Range	Material	Finish	Part Number			Hand Tool Part Number
				Strip Form (For Standard Applicator)	Strip Form (For Miniature Applicator)	Loose Piece	
18-16	.090-.130	Phosphor Bronze	Tin Plate	530505-2	530505-5	530506-1	90335-1
			Gold over Nickel ¹	530505-3	530505-6	530506-2	
			Selective Gold ²	530505-4	530505-7	530506-3	
		Beryllium Copper	Tin Plate	530507-2	530507-5	530508-1	
			Gold over Nickel ¹	530507-3	530507-6	530508-2	
			Selective Gold ²	530507-4	530507-7	530508-3	
22-18	.060-.090	Beryllium Copper	Tin Plate	530006-2	530006-5	530007-1	90027
			Gold over Nickel ¹	530006-3	530006-6	530007-2	
			Selective Gold ²	530006-4	530006-7	530007-3	
		Phosphor Bronze	Tin Plate	530002-2	530002-5	530003-1	
			Gold over Nickel ¹	530002-3	530002-6	530003-2	
			Selective Gold ²	530002-4	530002-7	530003-3	
26-22	.035-.055	Beryllium Copper	Tin Plate	530004-2	530004-5	530005-1	90094
			Gold over Nickel ¹	530004-3	530004-6	530005-2	
			Selective Gold ²	530004-4	530004-7	530005-3	
		Phosphor Bronze	Tin Plate	530000-2	530000-5	530001-1	
			Gold over Nickel ¹	530000-3	530000-6	530001-2	
			Selective Gold ²	530000-4	530000-7	530001-3	

Contact Extraction Tool Part No. 810992-1

Housing Specifications

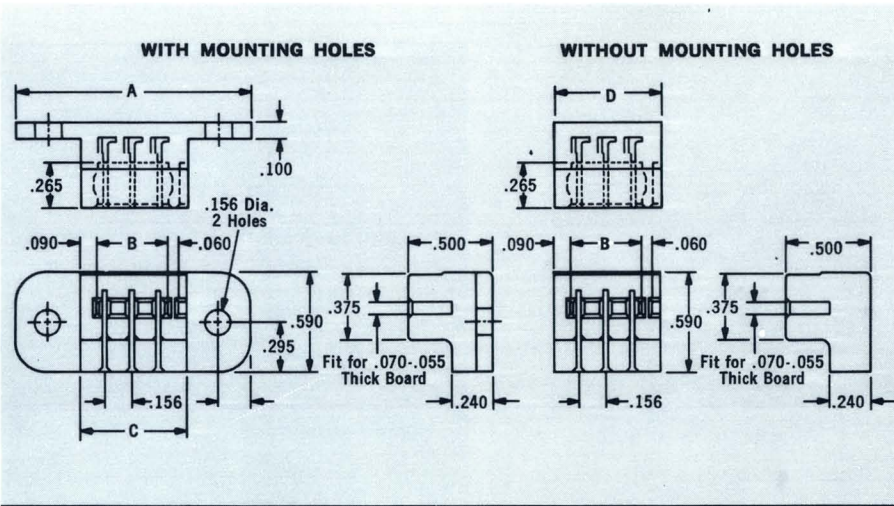

No. of Positions	Dimensions				Part Numbers		
	A	B	C	D	With Mounting Holes		Without Mounting Holes*
					(For Insulation Diameter Range .035-.090*)	(For Insulation Diameter Range .090-.130**)	
3	1.384	.414	.624	.624	582380-9	530509-4	582374-9
5	1.696	.726	.936	.936	582381-9	530509-5	582370-9
6	1.852	.882	1.092	1.092	582382-9	530509-1	582371-9
9	2.320	1.350	1.560	1.560	582383-9	530509-2	582375-9
12	2.788	1.818	2.028	2.028	582384-9	530509-6	582376-9
14	3.100	2.130	2.340	2.340	582385-9	530509-7	582372-9
15	3.256	2.286	2.496	2.496	582386-9	530509-3	582377-9
18	3.724	2.754	2.964	2.964	582387-9	530509-8	582378-9
22	4.348	3.378	3.588	3.588	582388-9	530509-9	582376-9

*For housing color see color code chart.
 **Available natural nylon only. Contact Series 530501 thru 530508 recommended.

HOUSING COLOR CODE

Suffix No.	Color	Suffix No.	Color
-1	Brown	-6	Blue
-2	Red	-7	Violet
-3	Orange	-8	Gray
-4	Yellow	-9	Natural
-5	Green	-0*	Black

*Also has prefix 1-

30 POSITION HOUSING

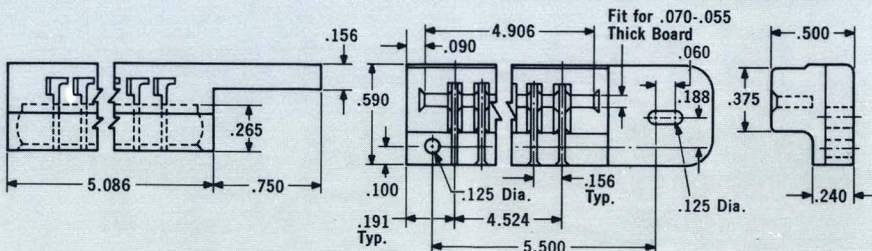

Part No. 582804-1 Natural Nylon — without mounting holes
 Part No. 583436-1 Natural Nylon — with mounting holes

SUGGESTED PRINTED CIRCUIT BOARD CUT-OUTS

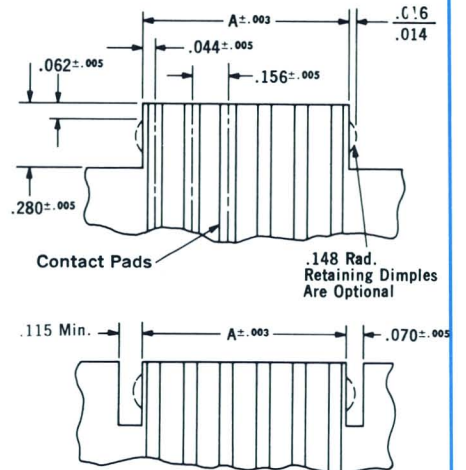

No. of Positions	"A" Dimension
3	.400
5	.712
6	.868
9	1.337
12	1.805
14	2.117
15	2.272
18	2.741
22	3.365

Recommended Board Thickness .055-.070"
 Recommended Chamfer of Mating Edge of Board—.015 x 45°
 Recommended Pad Plating-Tin, .00015 to .00040 Thickness

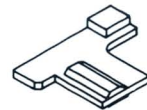

Circuit Path Keying Plug
 Part No. 583661-1 (Nylon)

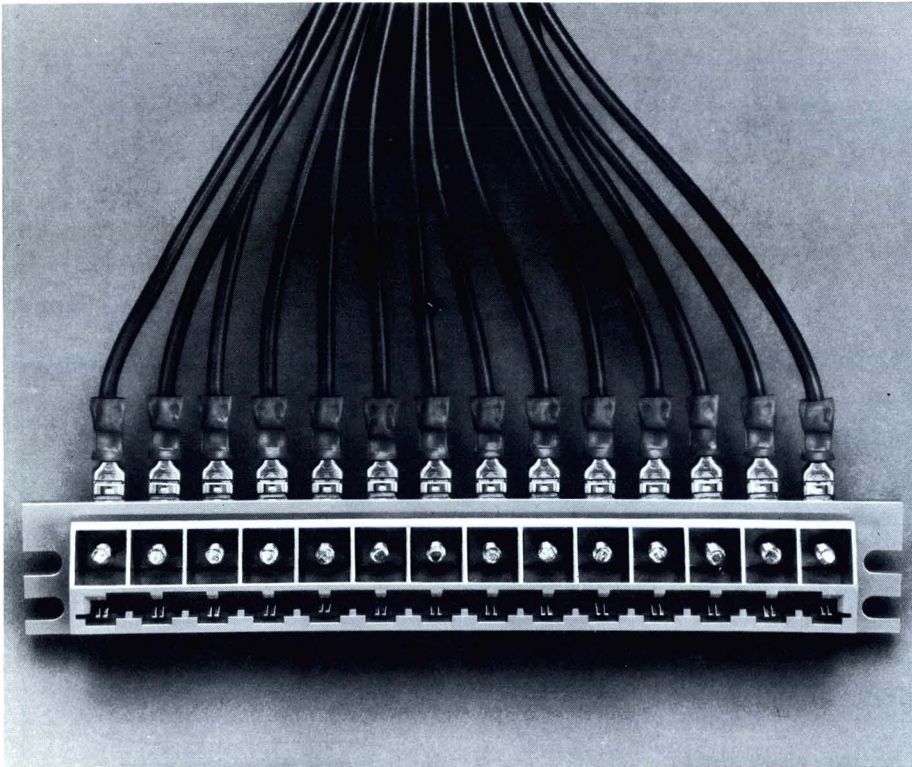

Bottom View — Card Entry Slot

Top View — Choice of External Wiring Techniques

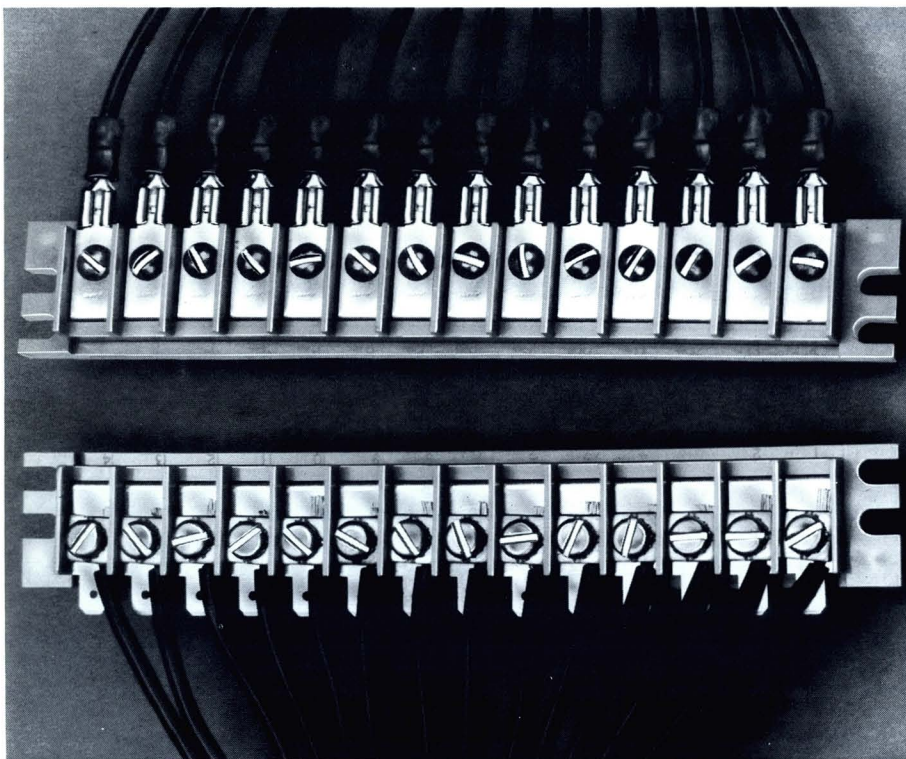

AMP Multiple Tap Printed Circuit Edge Connector

This combination edge connector-barrier block simplifies custom wiring and/or field installation of electronic equipment by providing a choice of hook-up wiring approaches.

Features

- Current rating — 5 amperes
- Operating temperature —
−85°F (−65°C) to +280°F,
(+137°C)
- Combination card edge connector/terminal block — accepts .062" thick board for quick, easy distribution of outputs.
- Choice of wire connections — either screw terminations for ring tongue or spade application and wire clamps for "bare" wire connections without terminals or .187 FASTON Tabs for quick connect/disconnects.
- Durable polycarbonate housings with one-piece phosphor bronze contacts.
- Firm mating action of bifurcated contacts and board pads assures excellent electrical and mechanical board connections.
- Gold over nickel or tin plated bifurcated contacts provide maximum resistance to corrosion and long life characteristics.
- Available in popular 8, 10, 12, 14 and 16 position sizes with contacts on .375" centers — for single sided P.C. boards and a 28 position double sided on .218 staggered centerlines.
- Keying plugs available.
- Other connector sizes can be supplied on request.

Single Sided P.C. Board Connectors

Various combinations of termination methods, materials, platings and connector sizes can be made available. For example, a special solder tail terminal is available for attaching LED displays (see drawing below). Consult your local AMP Sales Engineer of AMP Incorporated.

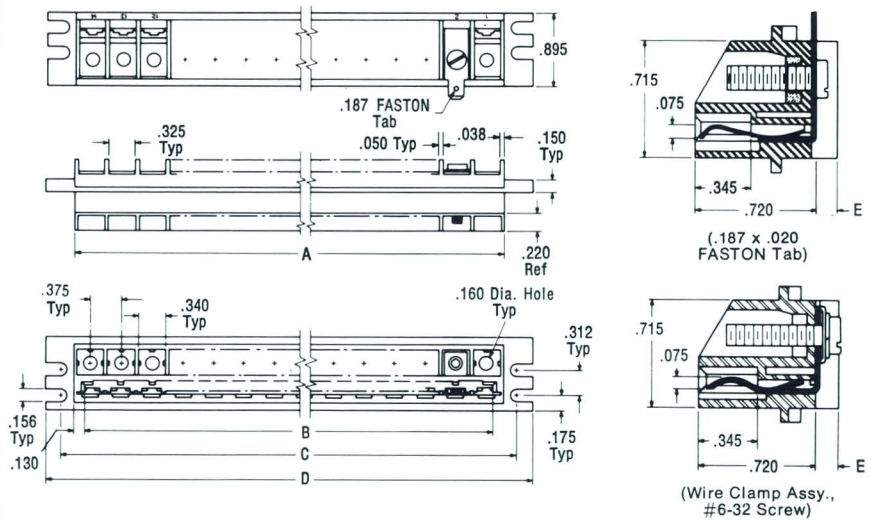
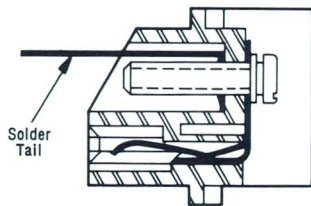

Housing Material: Polycarbonate
Contact Material: Phosphor Bronze
Screw Material: Steel

No. of Pos.	Termination		Contact Finish	Housing Color	Dimensions					Part Number
	Method	Finish			A	B	C	D	E	
8	FASTON Tab	Tin	Tin	Gray	3.025	2.765	3.375	3.750	.155	350172-1
	6-32 Screw	Cadmium	Tin	Gray	3.025	2.765	3.375	3.750	.155	350172-2
	FASTON Tab	Gold Flash	Gold Flash	Gray	3.025	2.765	3.375	3.750	.155	350172-3
	6-32 Screw	Cadmium	Gold Flash	Gray	3.025	2.765	3.375	3.750	.155	350172-4
	Wire Clamp Assy.	Gold Flash	Gold Flash	Gray	3.025	2.765	3.375	3.750	.155	350172-5
10	6-32 Screw	Cadmium	Tin	Gray	3.025	2.765	3.375	3.750	.155	350172-6
	Wire Clamp Assy.	Zinc	Tin	Gray	3.775	3.515	4.125	4.500	.155	640100-1
	FASTON Tab	Gold Flash	Gold Flash	Gray	4.525	4.265	4.875	5.250	.465	350475-1
12	6-32 Screw	Cadmium	Tin	Gray	4.525	4.265	4.875	5.250	.465	350475-2
	Wire Clamp Assy.	Zinc	Gold Flash	Black	4.525	4.265	4.875	5.250	.465	1-350475-1
	FASTON Tab	Gold Flash	Gold Flash	Black	4.525	4.265	4.875	5.250	.465	1-350475-2
14	Wire Clamp Assy.	Zinc	Gold Flash	Black	4.525	4.265	4.875	5.250	.465	1-350475-3
	FASTON Tab	Gold Flash	Gold Flash	Gray	5.275	5.015	5.625	6.000	.155	1-380914-0
	6-32 Screw	Cadmium	Tin	Gray	5.275	5.015	5.625	6.000	.155	1-380914-1
	FASTON Tab	Gold	Gold	Gray	5.275	5.015	5.625	6.000	.155	1-380914-2
	6-32 Screw	Cadmium	Gold	Gray	5.275	5.015	5.625	6.000	.155	1-380914-3
	Wire Clamp Assy.	Zinc	Gold Flash	Gray	5.275	5.015	5.625	6.000	.155	1-380960-0
	6-32 Screw	Cadmium	Tin	Gray	5.275	5.015	5.625	6.000	.155	1-380992-0
16	FASTON Tab Bent 45°	Gold Flash	Gold Flash	Gray	5.275	5.015	5.625	6.000	.155	640154-1
	6-32 Screw	Cadmium	Gold Flash	Gray	6.025	5.765	6.375	6.750	.155	1-380983-0
	Wire Clamp Assy.	Gold Flash	Gold Flash	Gray	6.025	5.765	6.375	6.750	.155	1-380983-1
	6-32 Screw	Cadmium	Gold Flash	Blue	6.025	5.765	6.375	6.750	.155	1-380983-2
	Wire Clamp Assy.	Zinc	Tin	Gray	6.025	5.765	6.375	6.750	.155	1-380983-3

Keying Plug

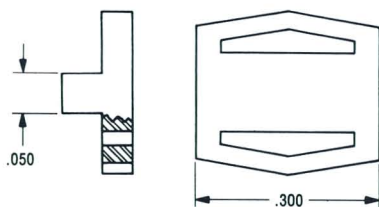

Material: Lexan, Clear
Part Number: 1-480602-0

Typical P.C. Board Layout

.062[±].007 thick single sided P.C. board

No. of Positions	L (Max.)
8	2.755
10	3.505
12	4.255
14	5.005
16	5.755

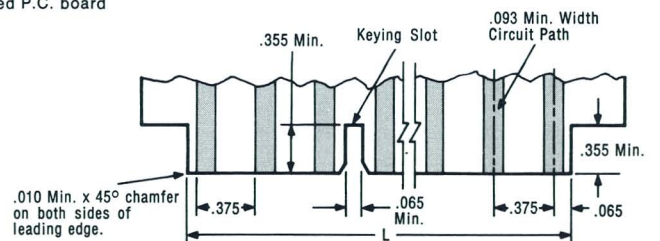

28 Position Double Sided P.C. Board Connector (14 position each side, staggered)

Keying Plug

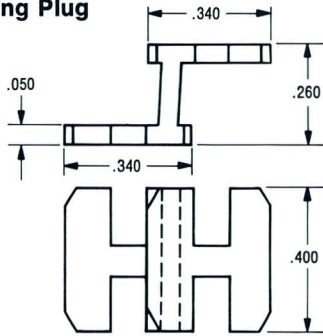

Part Number: 640109-1

Material: Polyester Thermoplastic, Natural Color

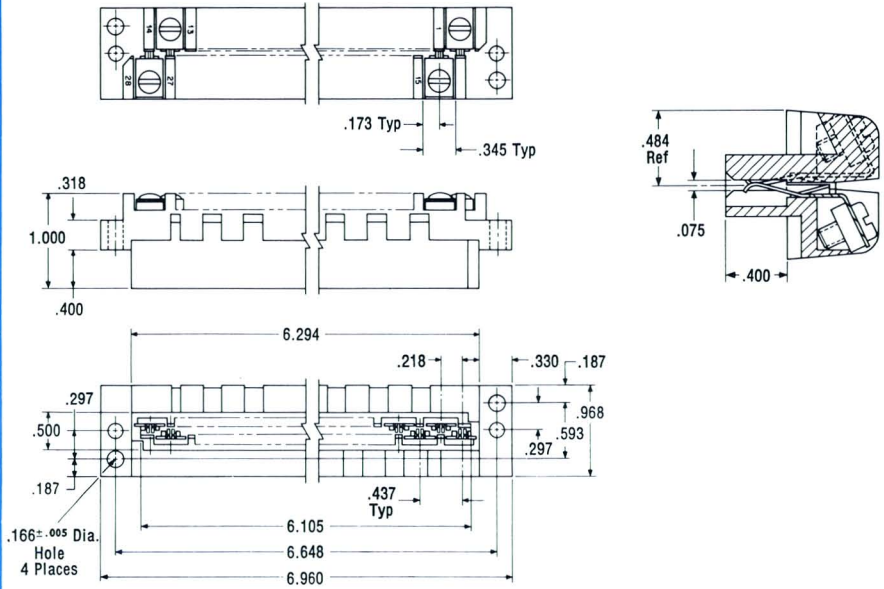

Housing Material: Polyester Thermoplastic, Natural Color

Contact Material: Brass

Part Numbers:

640113-1 Gold over Nickel plating

640113-2 Gold over Tin-Nickel over Nickel plating

Typical P.C. Board Layout

.062^{±.007} thick double sided P.C. board

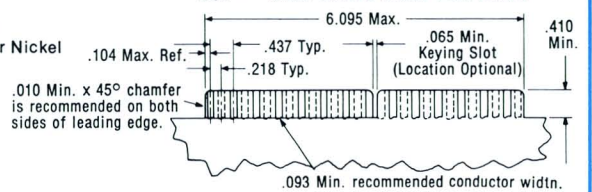

12 Position Feed-Thru Two, Single Sided P.C. Board Connector

Typical P.C. Board Layout

.062^{±.007} thick single sided P.C. board

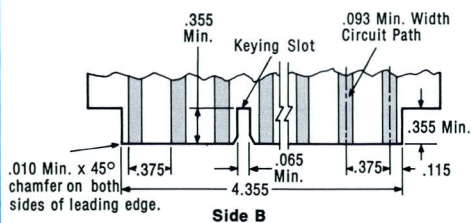

Side B

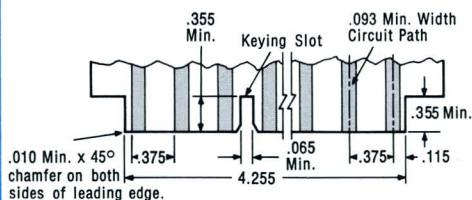

Side A

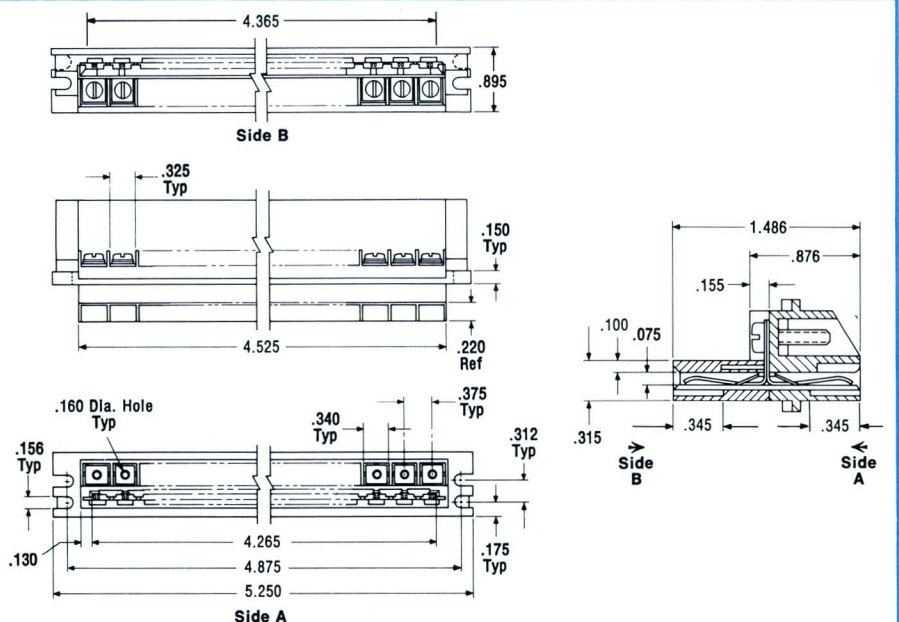

Housing Material: Polycarbonate, Gray Color

Contact Material: Phosphor Bronze

Part Numbers:

640209-1 Tin plating

640209-2 Gold flash

Use Keying Plug

Part Number: 1-480602-0

Printed Circuit Connectors

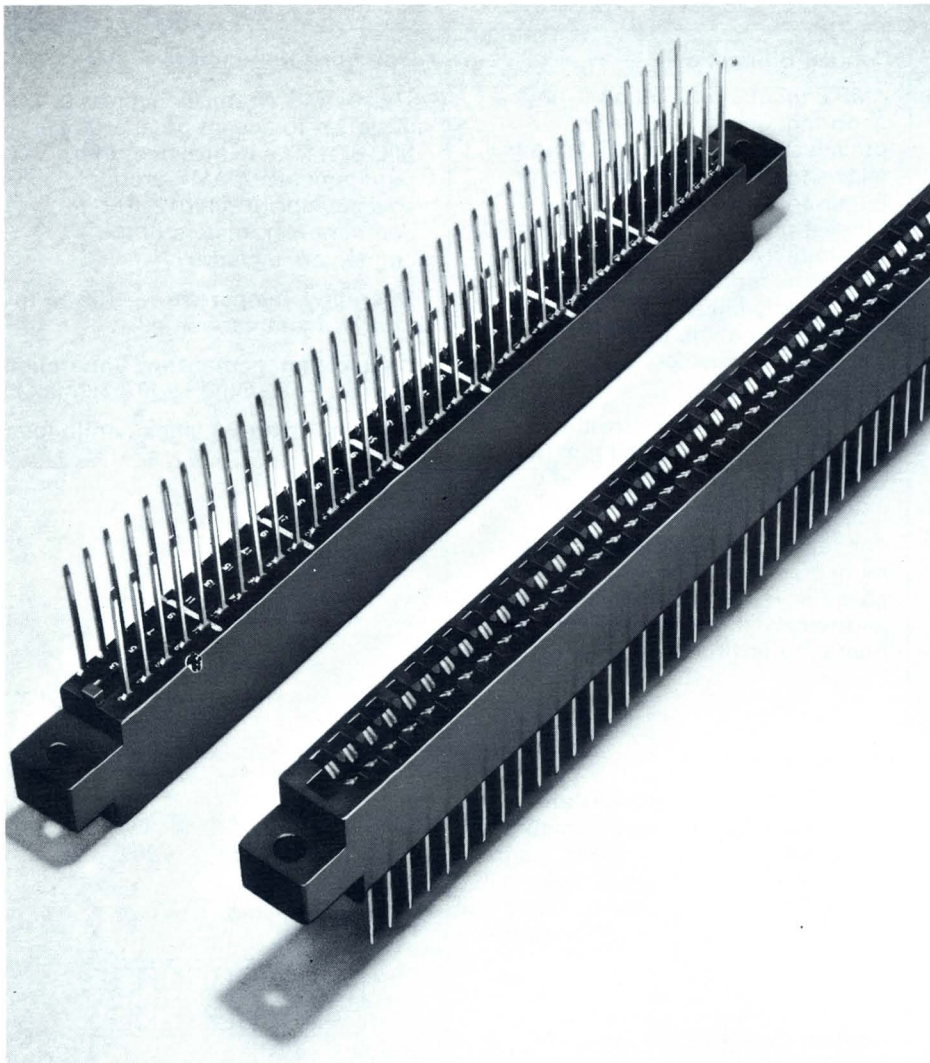

The AMP Wrap Connector is specifically designed to meet your requirements for economical packaging and interconnection of printed circuit boards. These reliable card entry connectors employ .025" square wrap type or solder type posts. These connectors are available, in .100" x .200" or .125" x .250" post centerlines, with or without threaded inserts.

The closed entry housings are made of glass filled polyester and are available in a variety of sizes offering a wide range of dual contact positions. They accommodate printed circuit boards from .054" to .071" thick and provide many additional features including polarizing keys.

All housings are furnished with one piece contacts. They are easily

removed for replacement by use of a simple extraction tool. The contact area of each contact is bifurcated for redundancy. This design feature assures excellent electrical and mechanical performance.

The AMP Wrap Connector combines reliability and product efficiency for economical packaging and interconnecting printed circuit boards. It can be used in a variety of panel assembly arrangements and can be terminated by automatic wrap type wiring machines for volume production or by hand tools and semi-automatic wiring machines for smaller production requirements. The solder type posts are ideally suited for printed circuit back planes not requiring point to point wiring.

AMP Wrap Printed Circuit Connectors .025" Square Posts



Features

- Contacts incorporate .025" sq. posts for wrap type or solder application
- One-piece contacts are bifurcated for redundancy and are removable using simple extraction tool
- Gold plating—.000015" or .000050" (.000030" gold plating available on request)
- Housings furnished in a variety of dual read-out positions
- Plain mounting holes or 4-40 threaded inserts
- Polarized keying is available.
- Low per line cost

Contact Bifurcation

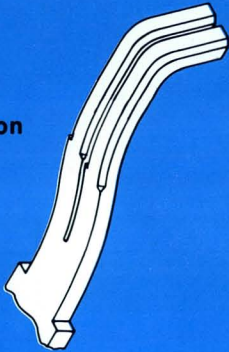

Post For Wrap Type Wiring

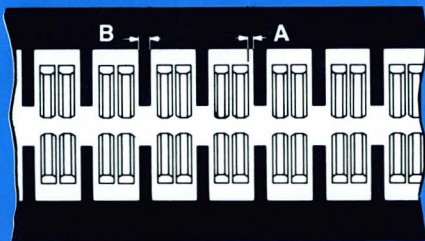

Contact Cavity

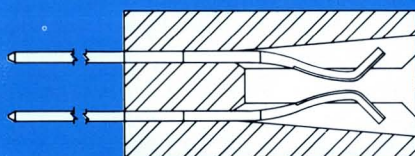

P.C. Board Entry

Contact Bifurcation

AMP's unique bifurcation is an important design feature that provides redundant contact points. It allows independent deflection of either contact tyne to assure the highest probability of uninterrupted continuity with the presence of foreign material on the board surface. This greatly enhances the reliability of the connection. Contacts are removable by using a simple extraction tool.

The chamfered edge provides a smooth surface for minimum board wear and uniform insertion and extraction forces.

The tapered beam design provides a more precise range of forces over the specified range of pc board thickness and resists stress relaxation in operating environments.

Post Quality

Post quality and tolerances are maintained by utilizing the accuracy of the stamping technique to insure standard max. .003 radius on post edges. This provides the optimum interface for wrap type terminations

Contact Cavity

The narrow bifurcated gap between bifurcation is designed to provide greater side clearance (A) with maximum barrier thickness (B) for greater strength and dielectric qualities. This also eliminates susceptibility of interference between the contact and the housing.

P.C. Board Entry

The recessed contact provides closed entry which prevents contact collapsing or stubbing during board insertion.

A deep chamfer is utilized on the housing to provide easy lead-in which minimizes board damage and facilitates insertion of warped P.C. boards.

Operating Parameters

These AMP Wrap Connectors are designed to accept pc boards per MIL-STD-275 and to meet the requirements of AMP product specification 108-14012. The operating parameters of the connectors include:

Operating Temperature—55 °C to +105 °C (continuous)

Contact Engagement and Separation Force—1 oz. (min.) to 16 oz. (max.)

Current Rating—3 amps continuous

Housing Marking

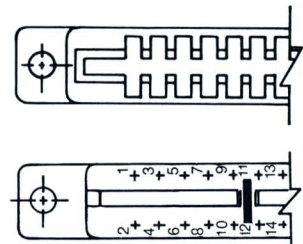

Contact Replacement Tool Part No. 265831-1



Connector Wiring

AMP'S .025" square post is approved by Gardner-Denver for hand, semi-automatic, and automatic wrap-type tooling applications for wire size Number 28-30 AWG.

Series 100

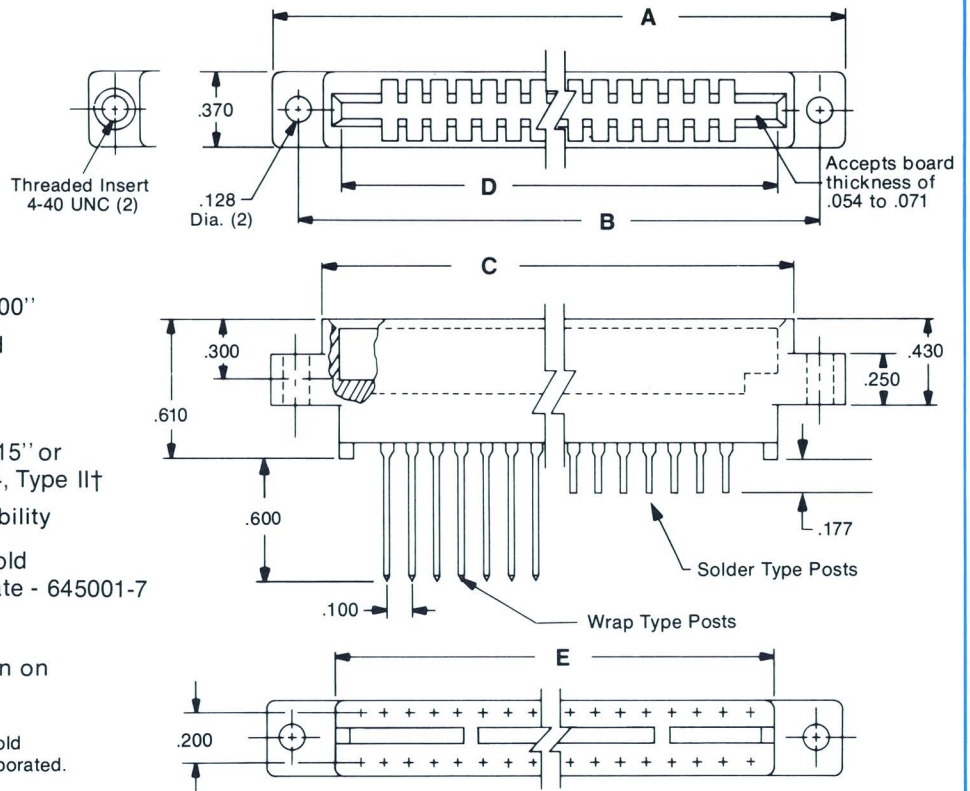

Post Size: .025" square

Post Centerline Spacing: .100" x .200"

Housing Material: Green glass-filled polyester

Contact Material: Copper alloy 725

Contact Plating: Contact area - .000015" or .000050" min. gold, per MIL-G-45204, Type II†

Post Plating: Gold flash for solderability

Replacement Contacts: .000015" gold plate - 645001-3 .000050" gold plate - 645001-7

Threaded Insert: Brass, 4-40 UNC

Housing Marking: Marking as shown on page two is standard.

†Connectors with contacts having .000030" gold plating are also available. Consult AMP Incorporated.

No. of Dual Positions	Wrap Type Posts		Solder Type Posts		A	B	C	D	E
	Without Threaded Inserts	With Threaded Inserts	Without Threaded Inserts	With Threaded Inserts					
15	67972-1* 4-67972-1**	67974-1* 4-67974-1**	67987-1* 4-67987-1**	67994-1* 4-67994-1**	2.34	2.075	1.76	1.600	1.65
18	67972-2* 4-67972-2**	67974-2* 4-67974-2**	67987-2* 4-67987-2**	67994-2* 4-67994-2**	2.64	2.375	2.06	1.900	1.95
22	67972-3* 4-67972-3**	67974-3* 4-67974-3**	67987-3* 4-67987-3**	67994-3* 4-67994-3**	3.04	2.775	2.46	2.300	2.35
25	67972-4* 4-67972-4**	67974-4* 4-67974-4**	67987-4* 4-67987-4**	67994-4* 4-67994-4**	3.34	3.075	2.76	2.600	2.65
28	67972-5* 4-67972-5**	67974-5* 4-67974-5**	67987-5* 4-67987-5**	67994-5* 4-67994-5**	3.64	3.375	3.06	2.900	2.95
30	67972-6* 4-67972-6**	67974-6* 4-67974-6**	67987-6* 4-67987-6**	67994-6* 4-67994-6**	3.84	3.575	3.26	3.100	3.15
31	67972-7* 4-67972-7**	67974-7* 4-67974-7**	67987-7* 4-67987-7**	67994-7* 4-67994-7**	3.94	3.675	3.36	3.200	3.25
35	67972-8* 4-67972-8**	67974-8* 4-67974-8**	67987-8* 4-67987-8**	67994-8* 4-67994-8**	4.34	4.075	3.76	3.600	3.65
36	67972-9* 4-67972-9**	67974-9* 4-67974-9**	67987-9* 4-67987-9**	67994-9* 4-67994-9**	4.44	4.175	3.86	3.700	3.75
40	1-67972-0* 5-67972-0**	1-67974-0* 5-67974-0**	1-67987-0* 5-67987-0**	1-67994-0* 5-67994-0**	4.84	4.575	4.26	4.100	4.15
43	1-67972-1* 5-67972-1**	1-67974-1* 5-67974-1**	1-67987-1* 5-67987-1**	1-67994-1* 5-67994-1**	5.14	4.875	4.56	4.400	4.45
50	1-67972-2* 5-67972-2**	1-67974-2* 5-67974-2**	1-67987-2* 5-67987-2**	1-67994-2* 5-67994-2**	5.84	5.575	5.26	5.100	5.15
60	1-67972-3* 5-67972-3**	1-67974-3* 5-67974-3**	1-67994-3* 5-67994-3**	1-67994-3* 5-67994-3**	6.84	6.575	6.26	6.100	6.15

*.000015" min. gold contact plating
**.000050" min. gold contact plating

Series 125

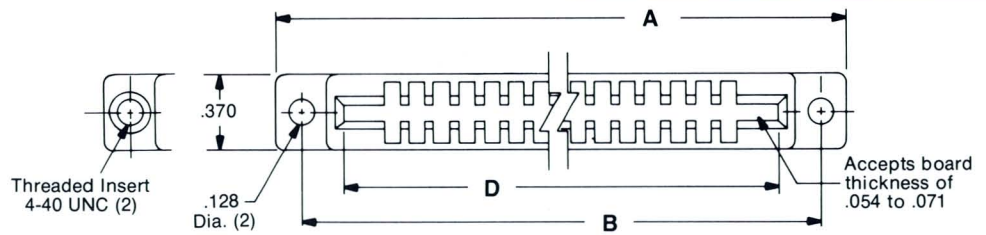

Post Size: .025" square

Post Centerline Spacing: .125" x .250"

Housing Material: Green glass-filled polyester

Contact Material: Copper Alloy 725

Contact Plating: Contact area - .000015" or .000050" min. gold, per MIL-G-45204, Type II†

Post Plating: Gold flash for solderability

Replacement Contacts: .000015" gold plate - 67967-3 .000050" gold plate - 67967-7

Polarizing Key: Intercontact type - Nylon Material: 67654-1

Threaded Insert: Brass, 4-40 UNC

Housing Marking: Marking as shown on page two is standard.

†Connectors with contacts having .000030" gold plating are also available. Consult AMP Incorporated.

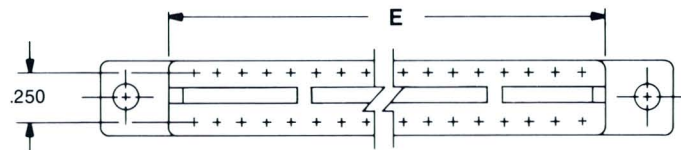
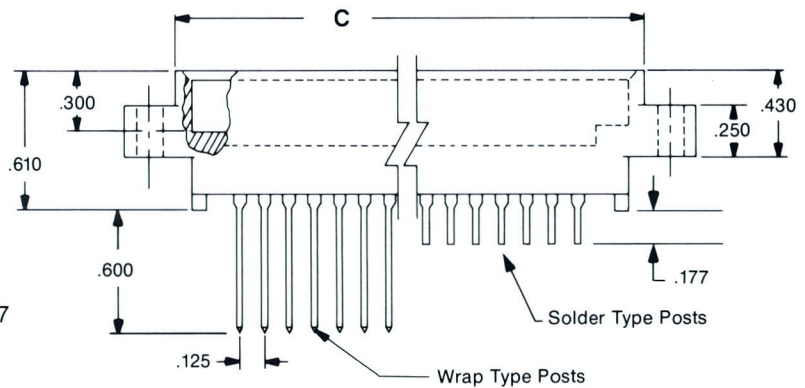

No. of Dual Positions	Wrap Type Posts		Solder Type Posts		A	B	C	D	E
	Without Threaded Inserts	With Threaded Inserts	Without Threaded Inserts	With Threaded Inserts					
15	67968-1* 4-67968-1**	67976-1* 4-67976-1**	67984-1* 4-67984-1**	67991-1* 4-67991-1**	2.68	2.420	2.16	2.000	2.00
18	1-67968-0* 5-46968-0**	67976-2* 4-67976-2**	67984-2* 4-67984-2**	67991-2* 4-67991-2**	3.06	2.795	2.54	2.375	2.38
22	67968-2* 4-67968-2**	67976-3* 4-67976-3**	67984-3* 4-67984-3**	67991-3* 4-67991-3**	3.56	3.295	3.04	2.875	2.88
28	67968-3* 4-67968-3**	67976-4* 4-67976-4**	67984-4* 4-67984-4**	67991-4* 4-67991-4**	4.30	4.045	3.78	3.625	3.62
30	1-67968-1* 5-67968-1**	67976-5* 4-67976-5**	67984-5* 4-67984-5**	67991-5* 4-67991-5**	4.56	4.295	4.04	3.875	3.88
31	67968-4* 4-67968-4**	67976-6* 4-67976-6**	67984-6* 4-67984-6**	67991-6* 4-67991-6**	4.68	4.420	4.16	4.000	4.00
35	67968-5* 4-67968-5**	67976-7* 4-67976-7**	67984-7* 4-67984-7**	67991-7* 4-67991-7**	5.18	4.920	4.66	4.500	4.50
36	1-67968-2* 5-67968-2**	67976-8* 4-67976-8**	67984-8* 4-67984-8**	67991-8* 4-67991-8**	5.30	5.045	4.78	4.625	4.62
40	67968-6* 4-67968-6**	67976-9* 4-67976-9**	67984-9* 4-67984-9**	67991-9* 4-67991-9**	5.80	5.545	5.28	5.125	5.12
43	67968-7* 4-67968-7**	1-67976-0* 5-67976-0**	1-67984-0* 5-67984-0**	1-67991-0* 5-67991-0**	6.18	5.920	5.66	5.500	5.50
50	67968-8* 4-67968-8**	1-67976-1* 5-67976-1**	1-67984-1* 5-67984-1**	1-67991-1* 5-67991-1**	7.06	6.795	6.54	6.375	6.38
60	67968-9* 4-67968-9**	1-67976-2* 5-67976-2**	1-67984-2* 5-67984-2**	1-67991-2* 5-67991-2**	8.30	8.045	7.78	7.625	7.62

*.000015" min. gold plating in contact area
 **.000050" min. gold plating in contact area

Printed Circuit Connectors

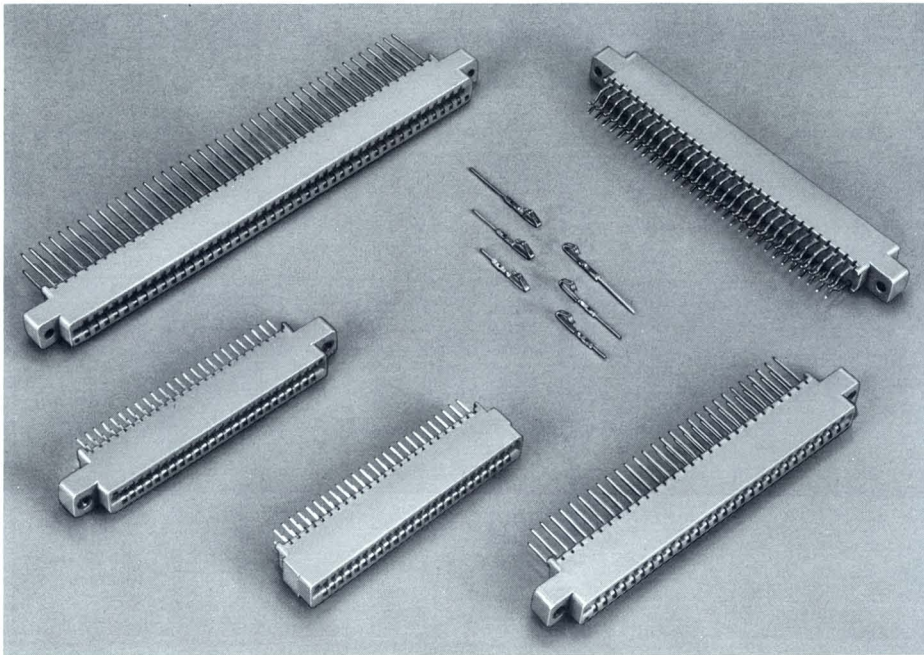

AMP economy wrap connectors have been designed with both reliability and cost in mind and are wrappable using automatic wrapping techniques. Connector body dimensions are completely compatible with most common industry standards for packaging double-sided .062" thick printed circuit boards, while the .025" sq. post configuration of the contacts meets standard wrap post specifications.

AMP offers these connectors pre-loaded and in two basic series: rack mounted connectors and solder type (solder-to-pc board) versions, which are also available with and without mounting ears. Both series can be furnished with dual contacts on .100" centers (.200" row-to-row) or .125" centers (.250" row-to-row) and in various sizes up to 50 dual contact positions.

Contacts are precision formed from copper-nickel-tin alloy CA 725, which is resistant to oxide build-up and can be used for wrap-type terminations without costly protective plating. As a result, gold plating is needed only in the contact mating area to establish positive electrical

continuity between the connector and board pads. The CA 725 material also has excellent strength and stress relaxation characteristics which, coupled with the contact leaf-spring design, allow the connector to absorb greater load deflection movement of a pc board and still maintain sufficient mating force between the contacts and board pads for a good electrical connection. A bifurcated design is used to achieve contact redundancy.

Contacts of rack mounted connectors are completely replaceable. They are inserted into the board edge side and can be replaced when the connector is mounted without disturbing adjacent terminations.

Other connector design features are: high performance thermo-plastic housings; molded-in cavity identification on the wiring side; index features molded into housings for "gang connector" alignment; contact springs preloaded against housing structure for reliable, uniform mating force; housings with standoffs for mother board mounting applications; plus a wide range of available options.

AMP Economy Wrap Connector

Features

- Available with .100" and .125" centerline spacings — sizes up to 50 dual contact positions
- Selectively gold plated contacts for high performance at low cost
- .025" sq. solid post configuration meets standard wrap post specifications
- Compatible with automatic wrapping techniques
- Bifurcated contacts for redundancy
- Replaceable contacts
- Recognized under the component program of Underwriters' Laboratories, Inc. 
- 94V-0 rated, glass-filled polyester housings
- Accepts .054" to .070" thick double-sided pc boards
- Wide choice of options: Intercontact keying, Gold plated posts for plug-on terminations, #4-40 threaded mounting inserts, Post lengths for flow soldered connections

Performance

- Contact Rating:** 3 Amperes (continuous current)
- Contact Resistance:** 12 Milliohms (max.)
- Operating Temperature:** -55°C to +105°C
- Voltage Rating (Sea Level):** 800 VAC (test)
- Insulation Resistance:** 5000 Megohms (min., after humidity)
- Vibration:** 10 to 500 Cycles per Second
- Individual Contact Engaging & Separation Forces:**
 - Engaging — 16 Oz. (max., per pair with .070 gage)
 - Separation — 1.25 Oz. (min., per pair with .054 gage)
- Humidity:** 90-95% (for 96 hours)

Rack Mount

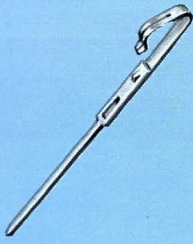

Contact with .025 sq. solid post
For Replacement Contacts, order:

Part No. 530357-2 (.100 \varnothing)
Part No. 530356-2 (.125 \varnothing)

Insertion/Extraction Tool No. 91120-1
AMP I.S. No. 7786

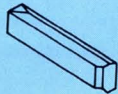

Keying Plug, Intercontact

Material: natural nylon
Part No. 530374-1

Material:

Housing — 94V-0 rated, glass-filled polyester; color, gray

Contacts — copper-nickel-tin alloy
CA 725

Finish:

Contacts with unplated posts for wrap-type terminations — .000050 gold in contact area

Contacts with tin plated posts for solder type terminations — .000030 gold in contact area

Notes:

- Other connector sizes within 6-to-50 dual position range available.
- Connectors also available with wide choice of options, including:

Gold plated posts for plug-on terminations, #4-40 threaded mounting inserts, shorting contacts, selective loading and loaded one side for single-sided pc boards.

Contact AMP Incorporated,
Harrisburg, Pa.

All dimensions in inches.

Specifications subject to change.
Consult AMP Incorporated for latest design specifications.

Specifications

.100 \varnothing on .200 Centers with Mounting Ears

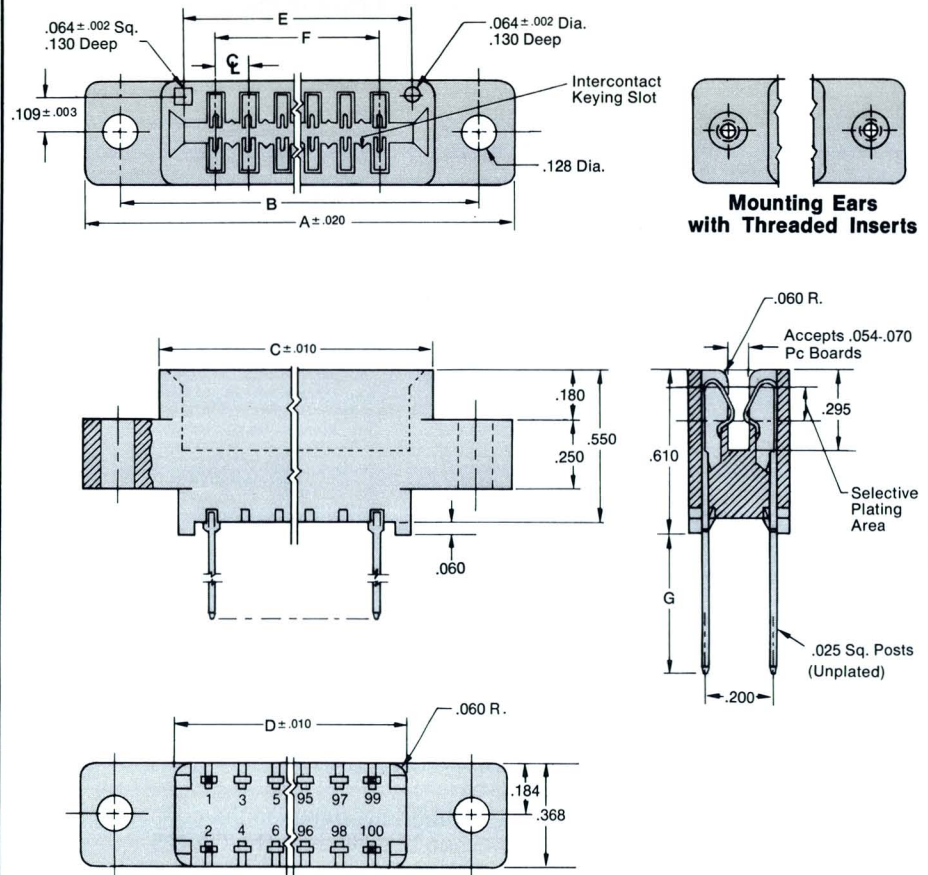

No. of Dual Positions	Dimensions							Max. No. Of Term. Per Post	Part Number	
	A	B	C	D	E	F	G		With Mounting Ears	Mounting Ears With Threaded Inserts
6	—	—	—	—	—	—	—	—	—	—
10	—	—	—	—	—	—	—	—	—	—
12	2.035	1.775	1.460	1.350	1.300	1.100	.570 .378	3 2	530355-1 1-530355-2	530360-1 1-530360-4
15	2.335	2.075	1.760	1.650	1.600	1.400	.570 .378	3 2	530355-2 1-530355-3	530360-2 1-530360-5
18	2.635	2.375	2.060	1.950	1.900	1.700	.570 .378	3 2	530355-3 1-530355-4	530360-3 1-530360-6
22	3.035	2.775	2.460	2.350	2.300	2.100	.570 .378	3 2	530355-4 1-530355-5	530360-4 1-530360-7
25	3.335	3.075	2.760	2.650	2.600	2.400	.570 .378	3 2	530355-5 1-530355-6	530360-5 1-530360-8
28	3.635	3.375	3.060	2.950	2.900	2.700	.570 .378	3 2	530355-6 1-530355-7	530360-6 530360-7
30	3.835	3.575	3.260	3.150	3.100	2.900	.570 .378	3 2	530355-7 1-530355-8	530360-7 2-530360-0
35	4.335	4.075	3.760	3.650	3.600	3.400	.570 .378	3 2	3-530355-4 3-530355-5	4-530360-0 4-530360-1
36	4.435	4.175	3.860	3.750	3.700	3.500	.570 .378	3 2	530355-8 1-530355-9	530360-9 2-530360-1
40	4.835	4.575	4.260	4.150	4.100	3.900	.570 .378	3 2	530355-9 2-530355-0	1-530360-0 2-530360-3
43	5.135	4.875	4.560	4.450	4.400	4.200	.570 .378	3 2	1-530355-0 2-530355-1	1-530360-1 2-530360-4
50	5.835	5.575	5.260	5.150	5.100	4.900	.570 .378	3 2	1-530355-1 2-530355-2	1-530360-3 2-530360-5

Rack Mount

.125 ϕ on .250 Centers with Mounting Ears

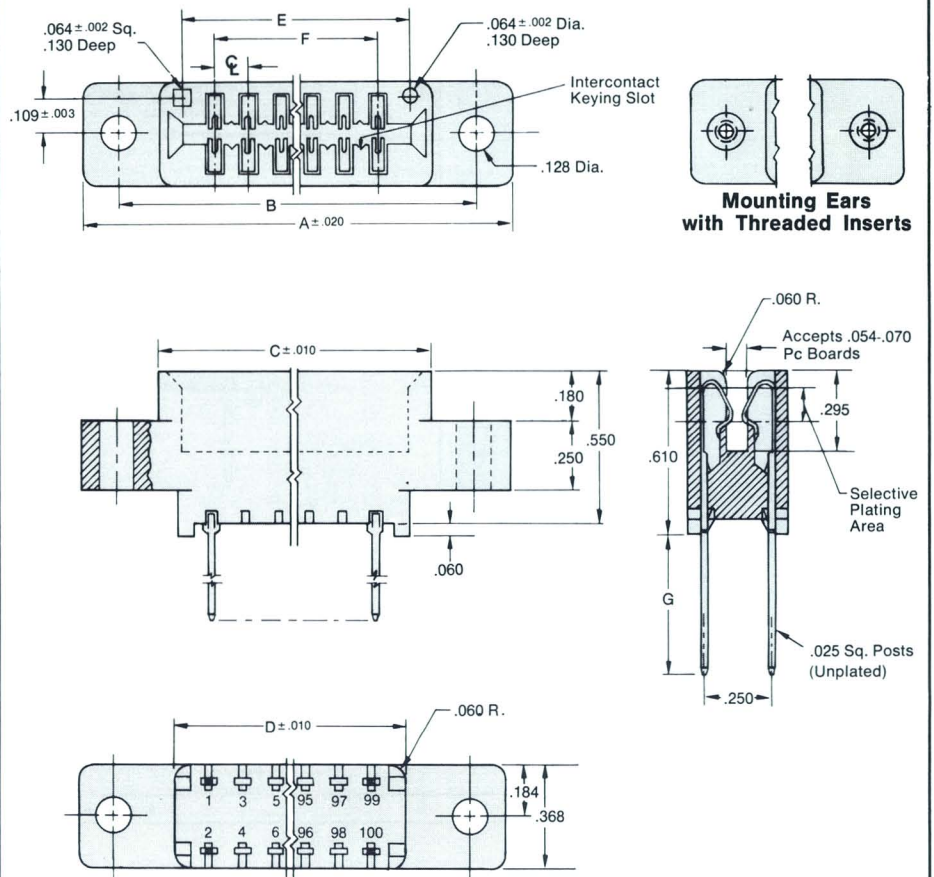

No. of Dual Positions	Dimensions							Max. No. Of Term. Per Post	Part Number	
	A	B	C	D	E	F	G		With Mounting Ears	Mounting Ears With Threaded Inserts
6	1.555	1.295	1.035	.875	.875	.625	.570	3	530352-1	530358-1
							.378	2	1-530352-2	1-530358-2
10	2.055	1.795	1.535	1.375	1.375	1.125	.570	3	530352-2	530358-2
							.378	2	1-530352-3	1-530358-3
12	—	—	—	—	—	—	—	—	—	—
15	2.680	2.420	2.160	2.000	2.000	1.750	.570	3	530352-3	530358-3
							.378	2	1-530352-4	1-530358-4
18	3.055	2.795	2.535	2.375	2.375	2.125	.570	3	530352-4	530358-4
							.378	2	1-530352-5	1-530358-5
22	3.555	3.295	3.035	2.875	2.875	2.625	.570	3	530352-5	530358-5
							.378	2	1-530352-6	1-530358-6
25	—	—	—	—	—	—	—	—	—	—
28	4.305	4.045	3.785	3.625	3.625	3.375	.570	3	530352-6	530358-6
							.378	2	1-530352-7	1-530358-7
30	4.555	4.295	4.035	3.875	3.875	3.625	.570	3	530352-7	530358-7
							.378	2	1-530352-8	1-530358-8
35	5.180	4.920	4.660	4.500	4.500	4.250	.570	3	3-530352-4	3-530358-4
							.378	2	3-530352-5	3-530358-5
36	5.305	5.045	4.785	4.625	4.625	4.375	.570	3	530352-8	530358-8
							.378	2	1-530352-9	1-530358-9
40	5.805	5.545	5.285	5.125	5.125	4.875	.570	3	530352-9	530358-9
							.378	2	2-530352-0	2-530358-0
43	6.180	5.920	5.660	5.500	5.500	5.250	.570	3	1-530352-0	1-530358-0
							.378	2	2-530352-1	2-530358-1
50	7.055	6.795	6.535	6.375	6.375	6.125	.570	3	1-530352-1	1-530358-1
							.378	2	2-530352-2	2-530358-2

Solder Type with Mounting Ears (Solder to pc Board)

Specifications (cont'd.)

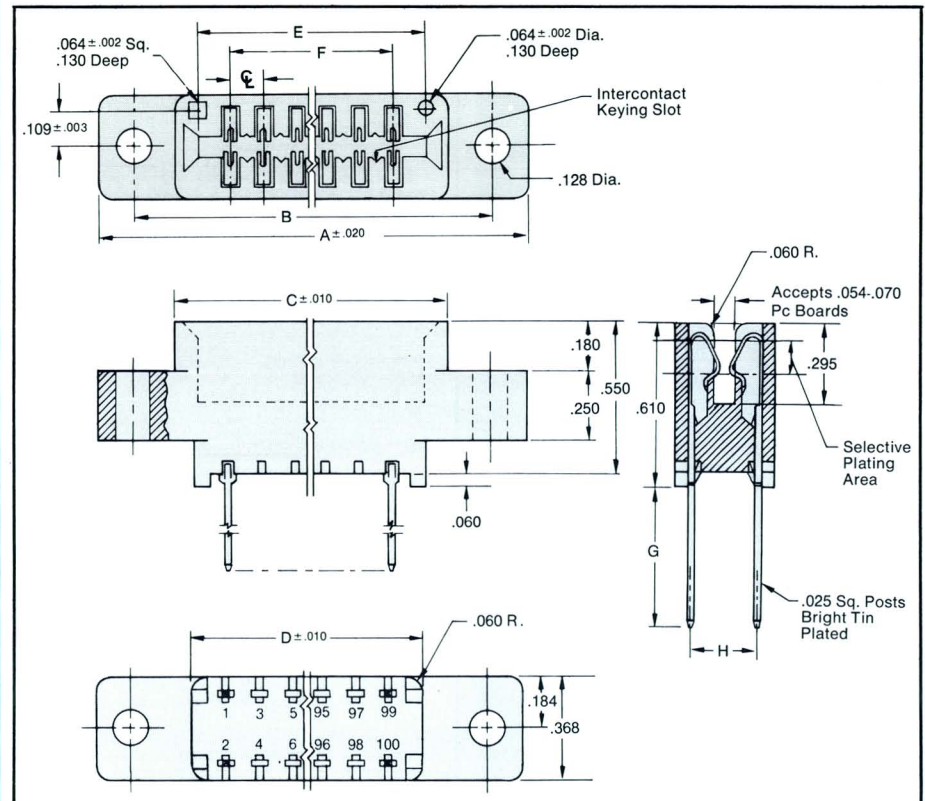

No. of Dual Positions	.100 Centers — Solder Type (With Mounting Ears) H=.200							Max. No. Of Term. Per Post	Part Number	.125 Centers — Solder Type (With Mounting Ears) H=.250							Max. No. Of Term. Per Post	Part Number
	Dimensions									Dimensions								
	A	B	C	D	E	F	G		A	B	C	D	E	F	G			
6	—	—	—	—	—	—	—	—	1.555	1.295	1.035	.875	.875	.625	.570	3	530367-1	
															.378	2	1-530367-2	
															.187	1	2-530367-3	
10	—	—	—	—	—	—	—	—	2.055	1.795	1.535	1.375	1.375	1.125	.570	3	530367-2	
															.378	2	1-530367-3	
															.187	1	2-530367-4	
12	2.035	1.775	1.460	1.350	1.300	1.100	—	—	—	—	—	—	—	—	.570	3	2-530363-3	
															.378	2	1-530363-2	
															.187	1	530363-1	
15	2.335	2.075	1.760	1.650	1.600	1.400	—	—	2.680	2.420	2.160	2.000	2.000	1.750	.570	3	2-530363-4	
															.378	2	1-530363-3	
															.187	1	530363-2	
18	2.635	2.375	2.060	1.950	1.900	1.700	—	—	3.055	2.795	2.535	2.375	2.375	2.125	.570	3	2-530363-5	
															.378	2	1-530363-4	
															.187	1	530363-3	
22	3.035	2.775	2.460	2.350	2.300	2.100	—	—	3.555	3.295	3.035	2.875	2.875	2.625	.570	3	2-530363-6	
															.378	2	1-530363-5	
															.187	1	530363-4	
25	3.335	3.075	2.760	2.650	2.600	2.400	—	—	—	—	—	—	—	—	.570	3	2-530363-7	
															.378	2	1-530363-6	
															.187	1	530363-5	
28	3.635	3.375	3.060	2.950	2.900	2.700	—	—	4.305	4.045	3.785	3.625	3.625	3.375	.570	3	2-530363-8	
															.378	2	1-530363-7	
															.187	1	530363-6	
30	3.835	3.575	3.260	3.150	3.100	2.900	—	—	4.555	4.295	4.035	3.875	3.875	3.625	.570	3	2-530363-9	
															.378	2	1-530363-8	
															.187	1	530363-7	
35	4.335	4.075	3.760	3.650	3.600	3.400	—	—	5.180	4.920	4.660	4.500	4.500	4.250	.570	3	3-530363-6	
															.378	2	2-530363-5	
															.187	1	3-530363-4	
36	4.435	4.175	3.860	3.750	3.700	3.500	—	—	5.305	5.045	4.785	4.625	4.625	4.375	.570	3	3-530363-0	
															.378	2	1-530363-9	
															.187	1	530363-8	
40	4.835	4.575	4.260	4.150	4.100	3.900	—	—	5.805	5.545	5.285	5.125	5.125	4.875	.570	3	3-530363-1	
															.378	2	2-530363-0	
															.187	1	530363-9	
43	5.135	4.875	4.560	4.450	4.400	4.200	—	—	6.180	5.920	5.660	5.500	5.500	5.250	.570	3	3-530363-2	
															.378	2	2-530363-1	
															.187	1	1-530363-0	
50	5.835	5.575	5.260	5.150	5.100	4.900	—	—	7.055	6.795	6.535	6.375	6.375	6.125	.570	3	3-530363-3	
															.378	2	2-530363-2	
															.187	1	1-530363-1	

Printed Circuit Board Layout

AMP economy wrap connectors are designed to accept printed circuit boards within a thickness range of .054" to .070". The overall width of a pc board must be within .005" to ensure alignment between the

circuit pads and the contacts in the connector. The following illustrations provide dimensional information for pc boards used in connectors with contacts on .100" and .125" centers.

.100 \varnothing Connectors

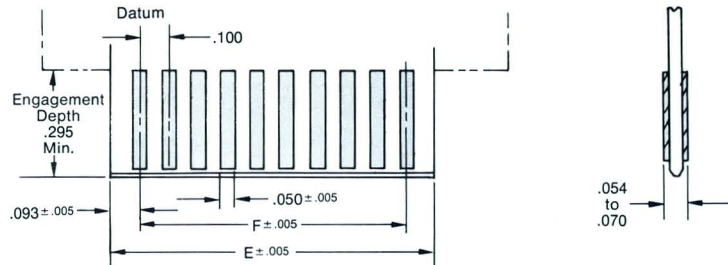

.125 \varnothing Connectors

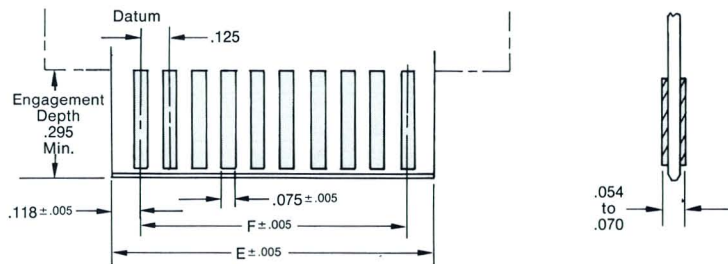

No. of Dual Positions	Connectors with .100 Centers		Connectors with .125 Centers	
	E	F	E	F
6	—	—	.865	.625
10	—	—	1.365	1.125
12	1.290	1.100	—	—
15	1.590	1.400	1.990	1.750
18	1.890	1.700	2.365	2.125
22	2.290	2.100	2.865	2.625
25	2.590	2.400	—	—
28	2.890	2.700	3.615	3.375
30	3.090	2.900	3.865	3.625
35	3.590	3.400	4.490	4.250
36	3.690	3.500	4.615	4.375
40	4.090	3.900	5.115	4.875
43	4.390	4.200	5.490	5.250
50	5.090	4.900	6.365	6.125

Note: E dim. above is E dim. - .010" of connectors.
F dim. above is exactly the same as F dim. of connectors.

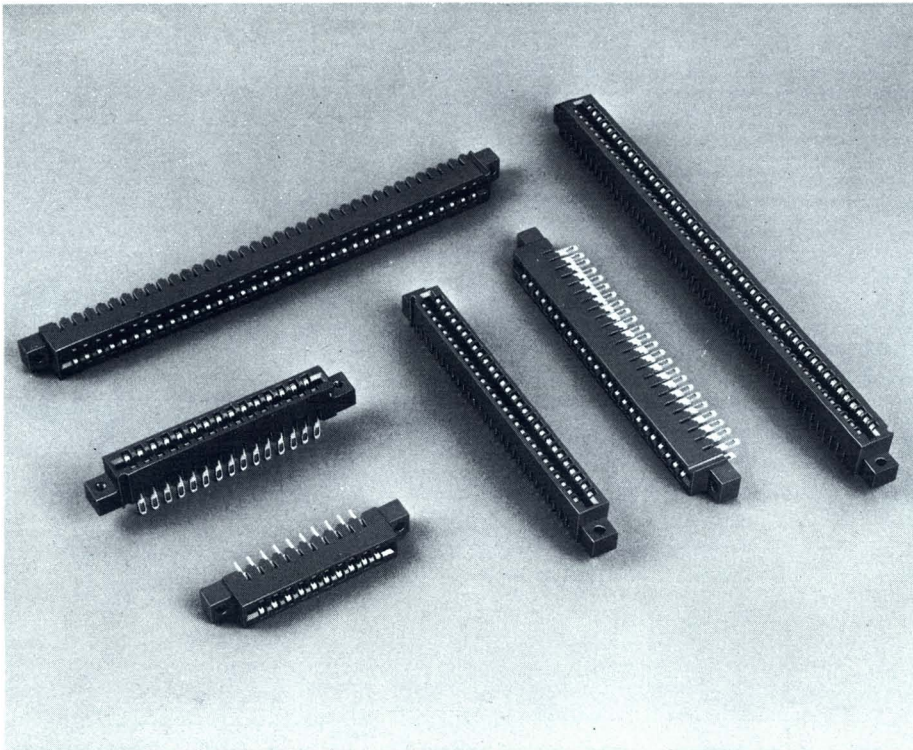

The AMP Low Profile Edge Connector is another example of AMP's ability to answer the need for high performance low cost connections.

By its very name "Low Profile" this connector family is designed to meet your packaging density requirements. Connector housings when mounted extend a mere .460 [11.68] from the mother board. For wire to board applications this low profile design permits greater use of available packaging space.

AMP Low Profile Edge Connectors are available in 6-44 dual positions on .156 [3.96] centerlines and 6-50 dual positions on .125 [3.18] centerlines. Both versions are supplied with either solder post contacts for mother-daughter board applications or solder eyelet contacts for wire to board applications.

All connectors feature clear slot entry and will accept .055-.070 [1.4-1.78] thick doublesided p.c. boards. The solder post connectors are available with .100 [2.54], .150 [3.18] and .180 [4.57] long tails on .140 [3.56] or .200 [5.08] row to row spacing.

Housings are made of impact resistant 94 V-O rated thermoplastic with molded in cavity identification and are available with or without mounting ears and a choice of threaded inserts or floating bushings. Additional housing features include intercontact keying, probe slot and number one position identification.

The precision formed contacts are made of phosphor bronze with selective gold plating on the contact mating surface only. This selective gold plating provides the highest degree of reliability while maintaining a low applied cost. The solder eyelets and posts are tin plated for improved solderability. The contact has a bifurcated design for redundancy. Optional shorting contacts are available.

All connector configurations are furnished pre-loaded. For added economy selectively loaded housings can be made available upon request. In addition, this contact design allows immediate replacement or repair of individual contacts without disconnecting the entire connector—without special tooling.

AMP Low Profile Edge Connector

Features

- Low profile housing-.460 [11.68] deep
- Available with 6-44 positions on .156 [3.96] centerlines and 6-50 positions on .125 [3.18] centerlines.
- Choice of solder eyelets for wire to board or solder posts for mother-daughter board applications.
- Selective gold plating on contact area for high performance at low cost.
- Bifurcated contacts for redundancy.
- Tin plated solder eyelets and tabs for greater solderability.
- Replaceable contacts—no special tooling.
- Accepts .055-.070 [1.4-1.78] p.c. boards.
- Housings available with or without mounting ears.
- Intercontact keying available.
- Also available with 4-40 threaded inserts or floating bushings.
- 94 V-O rated, glass-filled polyester housings.
- Variety of post lengths for solder connections.
- Contact current rating—5 amps per contact.
- Available on request—Product Specification—108-9044.

All dimensions in inches and millimetres.
Values in brackets are metric equivalents.

Specifications subject to change without notice.
For latest design drawings contact AMP
Incorporated.

.125 [3.18] Contact Centerline Spacing

Dimensioning:

1. All dimensions in inches and millimetres. Values in brackets are metric equivalents.
2. Charts contain dimensions in inches over millimetres.

.200 [5.08] Row to Row Spacing Solder Post for .052 [1.32] Dia. Hole

Material:

Housing—Glass filled polyester, green
 Contact—Phosphor bronze; Selective Plating—.000015 [0.00038] or .000030 [0.00076] min. gold over .000030 [0.00076] min. nickel, contact area;.000150 [0.00381] min. bright tin, post area.
 P.C. board thickness—.055-.070 [1.4-1.78]

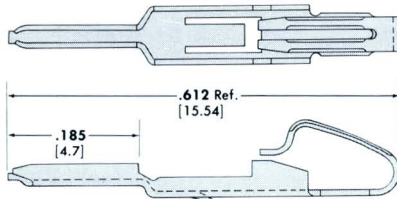

Replacement Contact**

Part Number: 1-530651-4

Selective Plating—.000030 [0.00076] min. gold

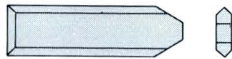

Inter Contact Keying Plug

Part Number: 530687-1

Glass filled Nylon

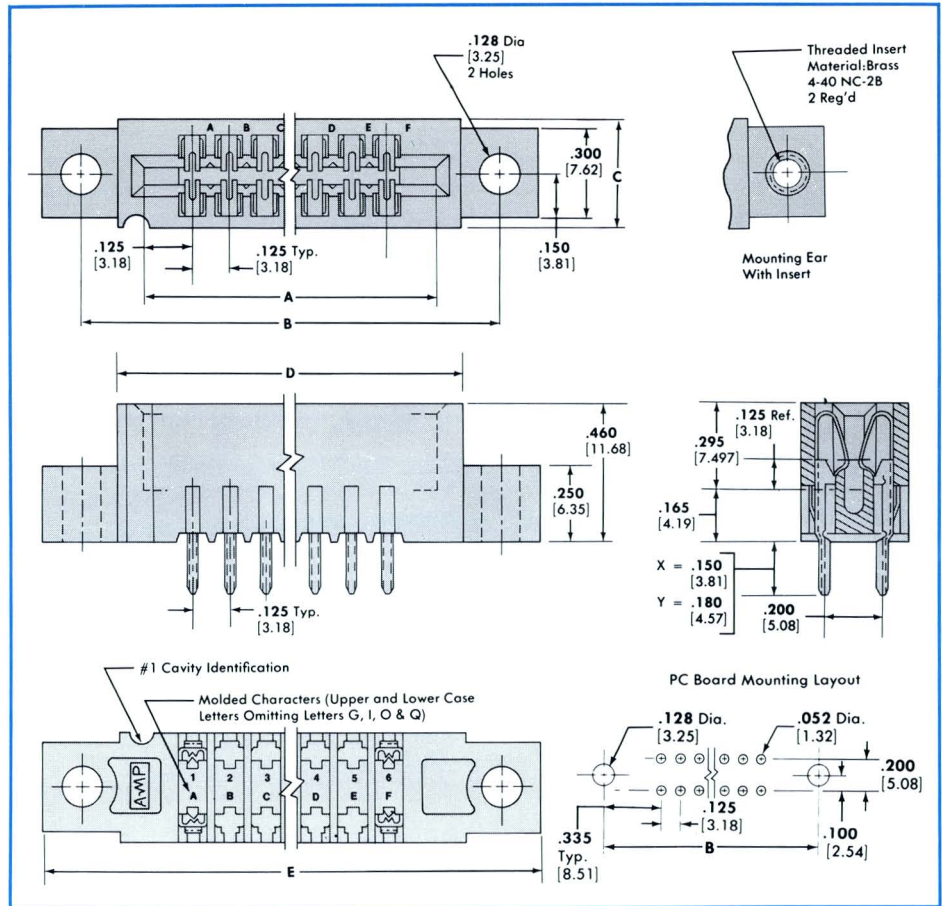

No. of Dual Positions	A	B*	C	D	E*	Post Length	Part Numbers					
							Mounting Ears		Mounting Ears with Inserts		Without Mounting Ears	
							.000015 Gold [0.00038]	.000030 Gold [0.00076]	.000015 Gold [0.00038]	.000030 Gold [0.00076]	.000015 Gold [0.00038]	.000030 Gold [0.00076]
6	.875 22.23	1.295 32.89	.370 9.4	1.035 26.29	1.555 39.5	X	530662-1	2-530662-1	530683-1	2-530683-1	530671-1	2-530671-1
						Y	530663-1	2-530663-1	530684-1	2-530684-1	530672-1	2-530672-1
10	1.375 34.93	1.795 45.59	.370 9.4	1.535 38.99	2.055 52.2	X	530662-2	2-530662-2	530683-2	2-530683-2	530671-2	2-530671-2
						Y	530663-2	2-530663-2	530684-2	2-530684-2	530672-2	2-530672-2
15	2.000 50.8	2.420 61.47	.370 9.4	2.160 54.86	2.680 68.07	X	530662-3	2-530662-3	530683-3	2-530683-3	530671-3	2-530671-3
						Y	530663-3	2-530663-3	530684-3	2-530684-3	530672-3	2-530672-3
18	2.375 60.33	2.795 70.99	.370 9.4	2.535 64.39	3.055 77.6	X	530662-4	2-530662-4	530683-4	2-530683-4	530671-4	2-530671-4
						Y	530663-4	2-530663-4	530684-4	2-530684-4	530672-4	2-530672-4
22	2.875 73.03	3.295 83.69	.370 9.4	3.035 77.09	3.555 90.3	X	530662-5	2-530662-5	530683-5	2-530683-5	530671-5	2-530671-5
						Y	530663-5	2-530663-5	530684-5	2-530684-5	530672-5	2-530672-5
28	3.625 92.08	4.045 102.74	.370 9.4	3.785 96.14	4.305 109.35	X	530662-6	2-530662-6	530683-6	2-530683-6	530671-6	2-530671-6
						Y	530663-6	2-530663-6	530684-6	2-530684-6	530672-6	2-530672-6
30	3.875 98.43	4.295 109.09	.370 9.4	4.035 102.49	4.555 115.7	X	530663-7	2-530662-7	530683-7	2-530683-7	530671-7	2-530671-7
						Y	530663-7	2-530663-7	530684-7	2-530684-7	530672-7	2-530672-7
31	4.000 101.6	4.420 112.27	.370 9.4	4.160 105.66	4.680 118.87	X	530662-8	2-530662-8	530683-8	2-530683-8	530671-8	2-530671-8
						Y	530663-8	2-530663-8	530684-8	2-530684-8	530672-8	2-530672-8
36	4.625 117.48	5.045 128.14	.370 9.4	4.785 121.54	5.305 134.75	X	530662-9	2-530662-9	530683-9	2-530683-9	530671-9	2-530671-9
						Y	530663-9	2-530663-9	530684-9	2-530684-9	530672-9	2-530672-9
40	5.125 130.18	5.545 140.84	.437 11.1	5.285 134.24	5.805 147.45	X	1-530662-0	3-530662-0	1-530683-0	3-530683-0	1-530671-0	3-530671-0
						Y	1-530663-0	3-530663-0	1-530684-0	3-530684-0	1-530672-0	3-530672-0
43	5.500 139.7	5.920 150.37	.437 11.1	5.660 143.76	6.180 156.97	X	1-530662-1	3-530662-1	1-530683-1	3-530683-1	1-530671-1	3-530671-1
						Y	1-530663-1	3-530663-1	1-530684-1	3-530684-1	1-530672-1	3-530672-1
50	6.375 161.93	6.795 172.59	.437 11.1	6.535 165.99	7.055 179.2	X	1-530662-2	3-530662-2	1-530683-2	3-530683-2	1-530671-2	3-530671-2
						Y	1-530663-2	3-530663-2	1-530684-2	3-530684-2	1-530672-2	3-530672-2

*These dimensions do not apply to connectors without mounting ears. **Refer to I.S. 7772 for contact replacement instructions.

.125 [3.18] Contact Centerline Spacing

Dimensioning:

- All dimensions in inches and millimetres. Values in brackets are metric equivalents.
- Charts contain dimensions in inches over millimetres.

.140 [3.56] Row to Row Spacing Solder Post for .052 Dia. Hole

Material:

Housing—Glass filled polyester, green
 Contact—Phosphor bronze; Selective
 Plating—.000015 [0.00038] or .000030 [0.00076] min. gold over .000030 [0.00076] min. nickel, contact area;
 .000150 [0.00381] min. bright tin, post area.

P.C. board thickness—.055-.070 [1.4-1.78]

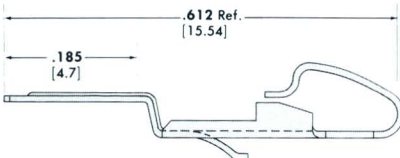
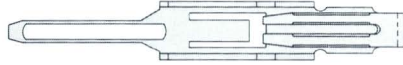

Replacement Contact**

Part Number: 1-530652-4
 Selective Plating—.000030 [0.00076] min. gold



Inter Contact Keying Plug

Part Number: 530687-1
 Glass filled Nylon

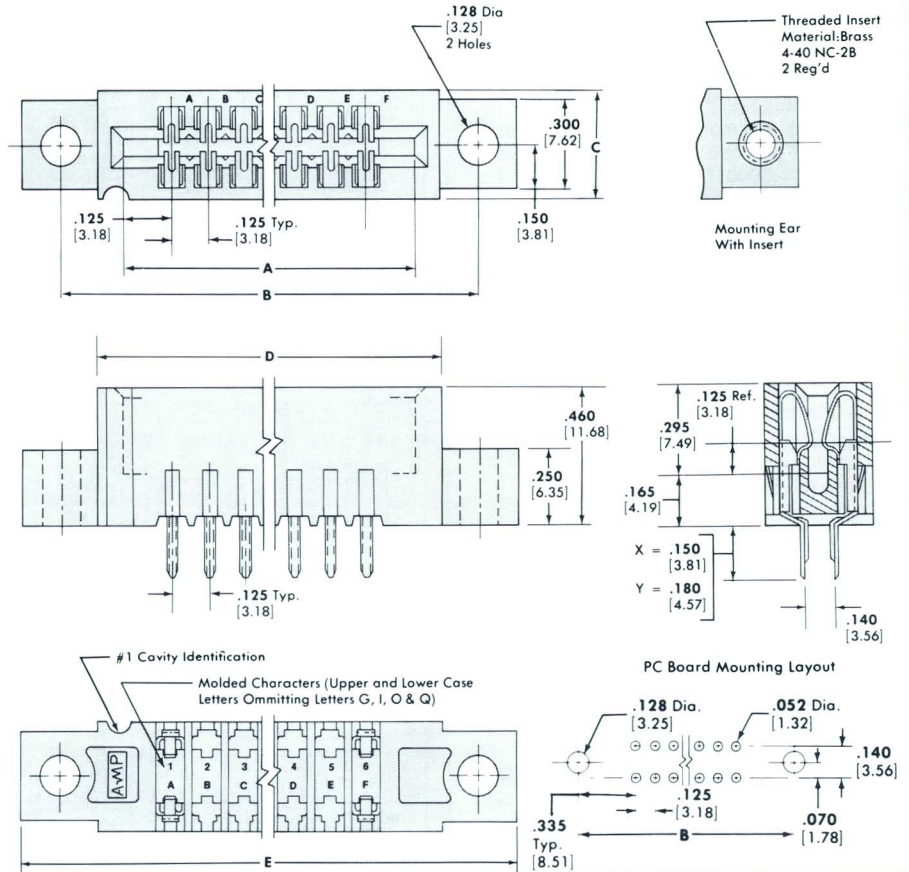

No. of Dual Positions	A	B*	C	D	E*	Post Length	Part Numbers					
							Mounting Ears		Mounting Ears with Inserts		Without Mounting Ears	
							.000015 Gold [0.00038]	.000030 Gold [0.00076]	.000015 Gold [0.00038]	.000030 Gold [0.00076]	.000015 Gold [0.00038]	.000030 Gold [0.00076]
6	.875 22.23	1.295 32.89	.370 9.4	1.035 26.29	1.555 39.5	X	530661-1	2-530661-1	530685-1	2-530685-1	530673-1	2-530673-1
						Y	530659-1	2-530659-1	530686-1	2-530686-1	530674-1	2-530674-1
10	1.375 34.93	1.795 45.59	.370 9.4	1.535 38.99	2.055 52.2	X	530661-2	2-530661-2	530685-2	2-530685-2	530673-2	2-530673-2
						Y	530659-2	2-530659-2	530686-2	2-530686-2	530674-2	2-530674-2
15	2.000 50.8	2.420 61.47	.370 9.4	2.160 54.86	2.680 68.07	X	530661-3	2-530661-3	530685-3	2-530685-3	530673-3	2-530673-3
						Y	530659-3	2-530659-3	530686-3	2-530686-3	530674-3	2-530674-3
18	2.375 60.33	2.795 70.99	.370 9.4	2.535 64.39	3.055 77.6	X	530661-4	2-530661-4	530685-4	2-530685-4	530673-4	2-530673-4
						Y	530659-4	2-530659-4	530686-4	2-530686-4	530674-4	2-530674-4
22	2.875 73.03	3.295 83.69	.370 9.4	3.035 77.09	3.555 90.3	X	530661-5	2-530661-5	530685-5	2-530685-5	530673-5	2-530673-5
						Y	530659-5	2-530659-5	530686-5	2-530686-5	530674-5	2-530674-5
28	3.625 92.08	4.045 102.74	.370 9.4	3.785 96.14	4.305 109.35	X	530661-6	2-530661-6	530685-6	2-530685-6	530673-6	2-530673-6
						Y	530659-6	2-530659-6	530686-6	2-530686-6	530674-6	2-530674-6
30	3.875 98.43	4.295 109.09	.370 9.4	4.035 102.49	4.555 115.7	X	530661-7	2-530661-7	530685-7	2-530685-7	530673-7	2-530673-7
						Y	530659-7	2-530659-7	530686-7	2-530686-7	530674-7	2-530674-7
31	4.000 101.6	4.420 112.27	.370 9.4	4.160 105.66	4.680 118.87	X	530661-8	2-530661-8	530685-8	2-530685-8	530673-8	2-530673-8
						Y	530659-8	2-530659-8	530686-8	2-530686-8	530674-8	2-530674-8
36	4.625 117.48	5.045 128.14	.370 9.4	4.785 121.54	5.305 134.75	X	530661-9	2-530661-9	530685-9	2-530685-9	530673-9	2-530673-9
						Y	530659-9	2-530659-9	530686-9	2-530686-9	530674-9	2-530674-9
40	5.125 130.18	5.545 140.84	.437 11.1	5.285 134.24	5.805 147.45	X	1-530661-0	3-530661-0	1-530685-0	3-530685-0	1-530673-0	3-530673-0
						Y	1-530659-0	3-530659-0	1-530686-0	3-530686-0	1-530674-0	3-530674-0
43	5.500 139.7	5.920 150.37	.437 11.1	5.660 143.76	6.180 156.97	X	1-530661-1	3-530661-1	1-530685-1	3-530685-1	1-530673-1	3-530673-1
						Y	1-530659-1	3-530659-1	1-530686-1	3-530686-1	1-530674-1	3-530674-1
50	6.375 161.93	6.795 172.59	.437 11.1	6.535 165.99	7.055 179.2	X	1-530661-2	3-530661-2	1-530685-2	3-530685-2	1-530673-2	3-530673-2
						Y	1-530659-2	3-530659-2	1-530686-2	3-530686-2	1-530674-2	3-530674-2

*These dimensions do not apply to connectors without mounting ears. **Refer to I.S.7772 for contact replacement instructions.

.125 Contact Centerline Spacing

Dimensioning:

1. All dimensions in inches and millimetres. Values in brackets are metric equivalents.
2. Charts contain dimensions in inches over millimetres.

Single Readout Solder Post for .052 [1.32] Dia. Hole

Material:

Housing—Glass filled polyester, green
 Contact—Phosphor bronze; Selective
 Plating—.000015 [0.00038] or .000030
 [0.00076] min. gold over .000030
 [0.00076] min. nickel, contact area;
 .000150 [0.00381] min. bright tin, post
 area.

P.C. board thickness—.055-.070 [1.4-1.78]

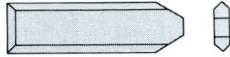

Inter Contact Keying Plug
 Part Number: 530687-1
 Glass filled Nylon

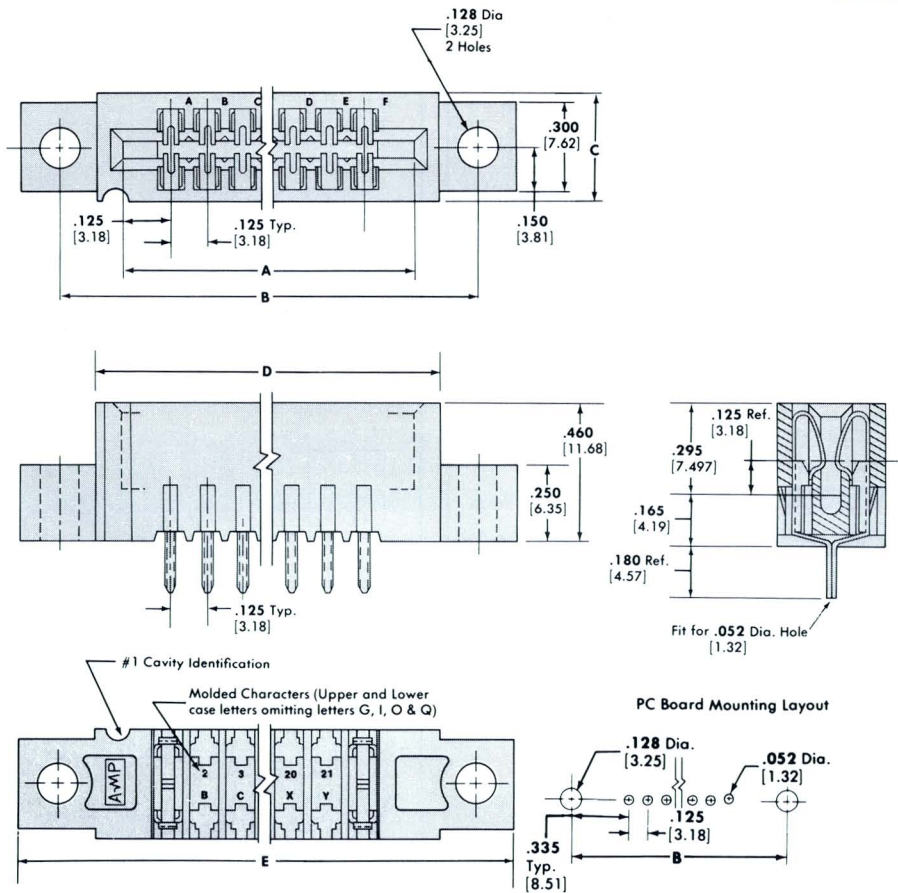

No. of Dual Positions	A	B*	C	D	E*	Part Numbers			
						Mounting Ears		Without Mounting Ears	
						.000015 Gold [0.00038]	.000030 Gold [0.00076]	.000015 Gold [0.00038]	.000030 Gold [0.00076]
6	.875 22.23	1.295 32.89	.370 9.4	1.035 26.29	1.555 39.5	530695-1	2-530695-1	530696-1	2-530696-1
10	1.375 34.93	1.795 45.59	.370 9.4	1.535 38.99	2.055 52.2	530695-2	2-530695-2	530696-2	2-530696-2
15	2.000 50.8	2.420 61.47	.370 9.4	2.160 54.86	2.680 68.07	530695-3	2-530695-3	530696-3	2-530696-3
18	2.375 60.33	2.795 70.99	.370 9.4	2.535 64.39	3.055 77.6	530695-4	2-530695-4	530696-4	2-530696-4
22	2.875 73.03	3.295 83.69	.370 9.4	3.035 77.09	3.555 90.3	530695-5	2-530695-5	530696-5	2-530696-5
28	3.625 92.08	4.045 102.74	.370 9.4	3.785 96.14	4.305 109.35	530695-6	2-530696-6	530696-6	2-530696-6
30	3.875 98.43	4.295 109.09	.370 9.4	4.035 102.49	4.555 115.7	530695-7	2-530695-7	530696-7	2-530696-7
31	4.000 101.6	4.420 112.27	.370 9.4	4.160 105.66	4.680 118.87	530695-8	2-530695-8	530696-8	2-530696-8
36	4.625 117.48	5.045 128.14	.370 9.4	4.785 121.54	5.305 134.75	530695-9	2-530695-9	530696-9	2-530696-9
40	5.125 130.18	5.545 140.84	.437 11.1	5.285 134.24	5.805 147.45	1-530695-0	3-530695-0	1-530696-0	3-530696-0
43	5.500 139.7	5.920 150.37	.437 11.1	5.660 143.76	6.180 156.97	1-530695-1	3-530695-1	1-530696-1	3-530696-1
50	6.375 161.93	6.795 172.59	.437 11.1	6.535 165.99	7.055 179.2	1-530695-2	3-530695-2	1-530696-2	3-530696-2

*These dimensions do not apply to connectors without mounting ears.

.125 [3.18] Contact Centerline Spacing

Dimensioning:

- All dimensions in inches and millimetres. Values in brackets are metric equivalents.
- Charts contain dimensions in inches over millimetres.

Solder Eyelet

Material:

Housing—Glass filled polyester, green
Contact—Phosphor bronze; selective
Plating—.000015
[0.00038] or .000030 [0.00076] min. gold
over .000030 [0.00076] min. nickel,
contact area; .000150 [0.00381] min.
bright tin, post area.
P.C. board thickness—.055-.070 [1.4-
1.78]

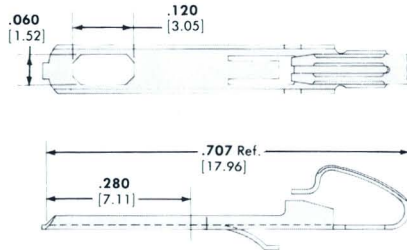

Replacement Contact**

Part Number: 1-530650-2
Selective Plating—.000030
[0.00076] min. gold

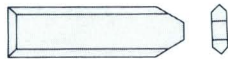

Inter Contact Keying Plug

Part Number: 530687-1
Glass filled Nylon

**Refer to I.S.7772 for contact replacement instructions.

Note: Sleeving is recommended over eyelet after soldering.

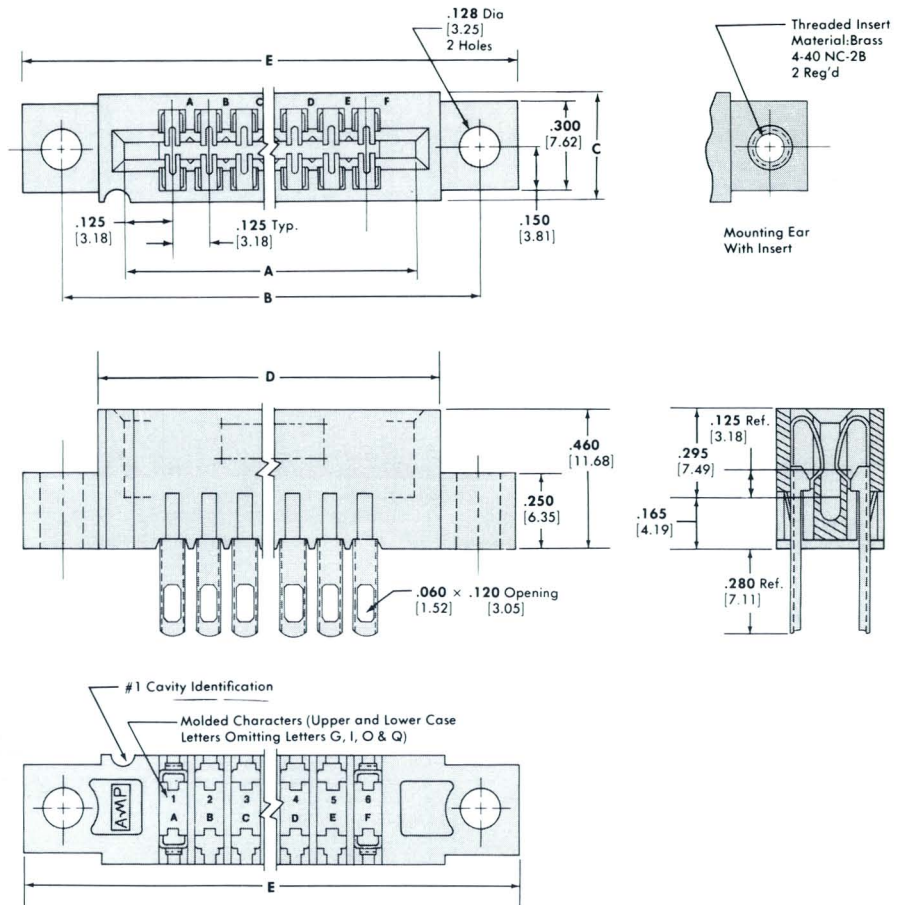

No. of Dual Positions	A	B*	C	D	E*	Part Numbers			
						Mounting Ears		Mounting Ears with Inserts	
						.000015 Gold [0.00038]	.000030 Gold [0.00076]	.000015 Gold [0.00038]	.000030 Gold [0.00076]
6	.875 22.23	1.295 32.89	.370 9.4	1.035 26.29	1.555 39.5	530664-1	2-530664-1	530682-1	2-530682-1
10	1.375 34.93	1.795 45.59	.370 9.4	1.535 38.99	2.055 52.2	530664-2	2-530664-2	530682-2	2-530682-2
15	2.000 50.8	2.420 61.47	.370 9.4	2.160 54.86	2.680 68.07	530664-3	2-530664-3	530682-3	2-530682-3
18	2.375 60.33	2.795 70.99	.370 9.4	2.535 64.39	3.055 77.6	530664-4	2-530664-4	530683-4	2-530682-4
22	2.875 73.03	3.295 83.69	.370 9.4	3.035 77.09	3.555 90.3	530664-5	2-530664-5	530682-5	2-530682-5
28	3.625 92.08	4.045 102.74	.370 9.4	3.785 96.14	4.305 109.35	530664-6	2-530664-6	530682-6	2-530682-6
30	3.875 98.43	4.295 109.09	.370 9.4	4.035 102.49	4.555 115.7	530664-7	2-530664-7	530682-7	2-530682-7
31	4.000 101.6	4.420 112.27	.370 9.4	4.160 105.66	4.680 118.87	530664-8	2-530664-8	530682-8	2-530682-8
36	4.625 117.48	5.045 128.14	.370 9.4	4.785 121.54	5.305 134.75	530664-9	2-530664-9	530682-9	2-530682-9
40	5.125 130.18	5.545 140.84	.437 11.1	5.285 134.24	5.805 147.45	1-530664-0	3-530664-0	1-530682-0	3-530682-0
43	5.500 139.7	5.920 150.37	.437 11.1	5.660 143.76	6.180 156.97	1-530664-1	3-530664-1	1-530682-1	3-530682-1
50	6.375 161.93	6.795 172.59	.437 11.1	6.535 165.99	7.055 179.2	1-530664-2	3-530664-2	1-530682-2	3-530682-2

*These dimensions do not apply to connectors without mounting ears.

.156 [3.96] Contact Centerline Spacing

- Dimensioning:
- All dimensions in inches and millimetres. Values in brackets are metric equivalents.
 - Charts contain dimensions in inches over millimetres.

.200 [5.08] Row to Row Spacing Solder Post for .052 [1.32] Dia. Hole

Material:
 Housing—Glass filled polyester, green
 Contact—Phosphor bronze; Selective Plating—
 .000015 [0.00038] or .000030 [0.00076] min. gold over .000030 [0.00076] min. nickel, contact area; .000150 [0.00381] min. bright tin, post area.
 P.C. board thickness—.055–.070 [1.4–1.78]

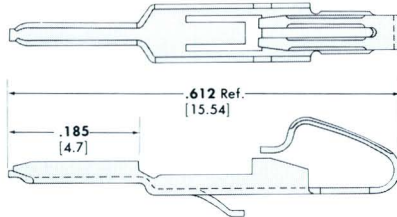

Replacement Contact**
 Part Number: 1-530651-4
 Selective Plating—.000030 [0.00076] min. gold

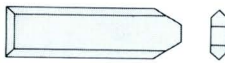

Inter Contact Keying Plug
 Part Number: 530687-1
 Glass filled Nylon

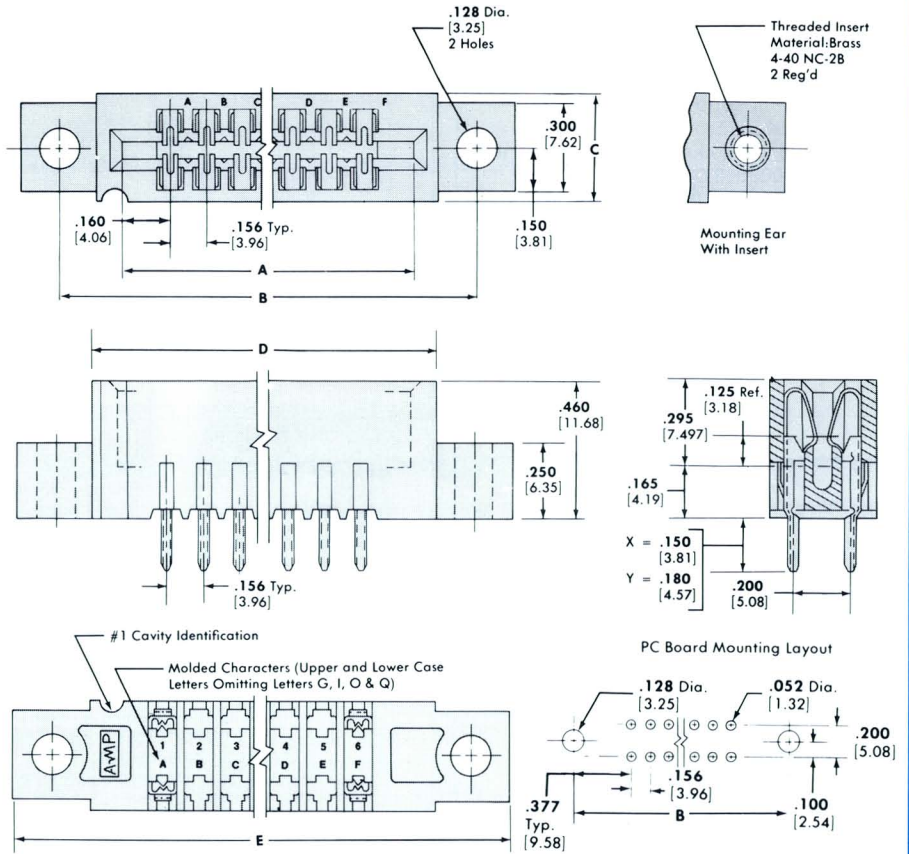

No. of Dual Positions	A	B*	C	D	E*	Part Numbers						
						Post Length	Mounting Ears		Mounting Ears with Inserts		Without Mounting Ears	
							.000015 Gold [0.00038]	.000030 Gold [0.00076]	.000015 Gold [0.00038]	.000030 Gold [0.00076]	.000015 Gold [0.00038]	.000030 Gold [0.00076]
6	1.100 27.94	1.535 38.99	.370 9.4	1.240 31.5	1.785 45.34	X	530655-1	2-530655-1	530677-1	2-530677-1	530666-1	2-530666-1
						Y	530656-1	2-530656-1	530678-1	2-530678-1	530667-1	2-530667-1
10	1.724 43.79	2.159 54.84	.370 9.4	1.864 47.35	2.409 61.19	X	530655-2	2-530655-2	530677-2	2-530677-2	530666-2	2-530666-2
						Y	530656-2	2-530656-2	530678-2	2-530678-2	530667-2	2-530667-2
12	2.036 51.71	2.471 62.76	.370 9.4	2.176 55.27	2.721 69.11	X	530655-3	2-530655-3	530677-3	2-530677-3	530666-3	2-530666-3
						Y	530656-3	2-530656-3	530678-3	2-530678-3	530667-3	2-530667-3
15	2.504 63.60	2.939 74.65	.370 9.4	2.644 67.16	3.189 81.	X	530655-4	2-530655-4	530677-4	2-530677-4	530666-4	2-530666-4
						Y	530656-4	2-530656-4	530678-4	2-530678-4	530667-4	2-530667-4
18	2.972 75.49	3.407 86.54	.370 9.4	3.112 79.04	3.657 92.89	X	530655-5	2-530655-5	530677-5	2-530677-5	530666-5	2-530666-5
						Y	530656-5	2-530656-5	530678-5	2-530678-5	530667-5	2-530667-5
22	3.596 91.34	4.031 102.39	.370 9.4	3.736 94.89	4.281 108.74	X	530655-6	2-530655-6	530677-6	2-530677-6	530666-6	2-530666-6
						Y	530656-6	2-530656-6	530678-6	2-530678-6	530667-6	2-530667-6
24	3.908 99.26	4.343 110.31	.370 9.4	4.048 102.82	4.593 116.66	X	530655-7	2-530655-7	530677-7	2-530677-7	530666-7	2-530666-7
						Y	530656-7	2-530656-7	530678-7	2-530678-7	530667-7	2-530667-7
25	4.064 103.23	4.499 114.27	.370 9.4	4.204 106.78	4.749 120.62	X	530655-8	2-530655-8	530677-8	2-530677-8	530666-8	2-530666-8
						Y	530656-8	2-530656-8	530678-8	2-530678-8	530667-8	2-530667-8
28	4.532 115.11	4.967 126.16	.370 9.4	4.672 118.67	5.217 132.51	X	1-530655-2	3-530655-2	1-530677-2	3-530677-2	1-530666-2	3-530666-2
						Y	1-530656-2	3-530656-2	1-530678-2	3-530678-2	1-530667-2	3-530667-2
30	4.844 123.04	5.279 134.09	.437 11.1	4.984 126.59	5.529 140.44	X	530655-9	2-530655-9	530677-9	2-530677-9	530666-9	2-530666-9
						Y	530656-9	2-530656-9	530678-9	2-530678-9	530667-9	2-530667-9
36	5.780 146.18	6.215 157.86	.437 11.1	5.920 150.37	6.465 164.21	X	1-530656-0	3-530655-0	1-530677-0	3-530677-0	1-530666-0	3-530666-0
						Y	1-530656-0	3-530656-0	1-530678-0	3-530678-0	1-530667-0	3-530667-0
43	6.872 174.55	7.307 185.6	.437 11.1	7.012 178.1	7.557 191.95	X	1-530655-3	3-530655-3	1-530677-3	3-530677-3	1-530666-3	3-530666-3
						Y	1-530656-3	3-530656-3	1-530678-3	3-530678-3	1-530667-3	3-530667-3
44	7.028 178.51	7.463 189.56	.437 11.1	7.168 182.07	7.713 196.91	X	1-530655-1	3-530655-1	1-530677-1	3-530677-1	1-530666-1	3-530666-1
						Y	1-530656-1	3-530656-1	1-530678-1	3-530678-1	1-530667-1	3-530667-1

*These dimensions do not apply to connectors without mounting ears. **Refer to I.S.7772 for contact replacement instructions.

.156 [3.96] Contact Centerline Spacing

Dimensioning:

- All dimensions in inches and millimetres. Values in brackets are metric equivalents.
- Charts contain dimensions in inches over millimetres.

.140 [3.56] Row to Row Spacing Solder Post for .052 [1.32] Dia. Hole

Material:

Housing—Glass filled polyester, green
Contact—Phosphor bronze; Selective Plating—

.000015 [0.00038] or .000030 [0.00076] min. gold over .000030 [0.00076] min. nickel, contact area; .000150 [0.00381] min. bright tin, post area.

P.C. board thickness—.055-.070 [1.4-1.78]

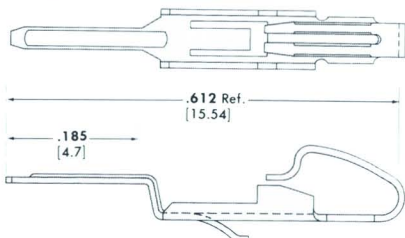

Replacement Contact**

Part Number: 1-530652-4

Selective Plating—.000030 [0.00076] min. gold

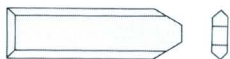

Inter Contact Keying Plug

Part Number: 530687-1

Glass filled Nylon

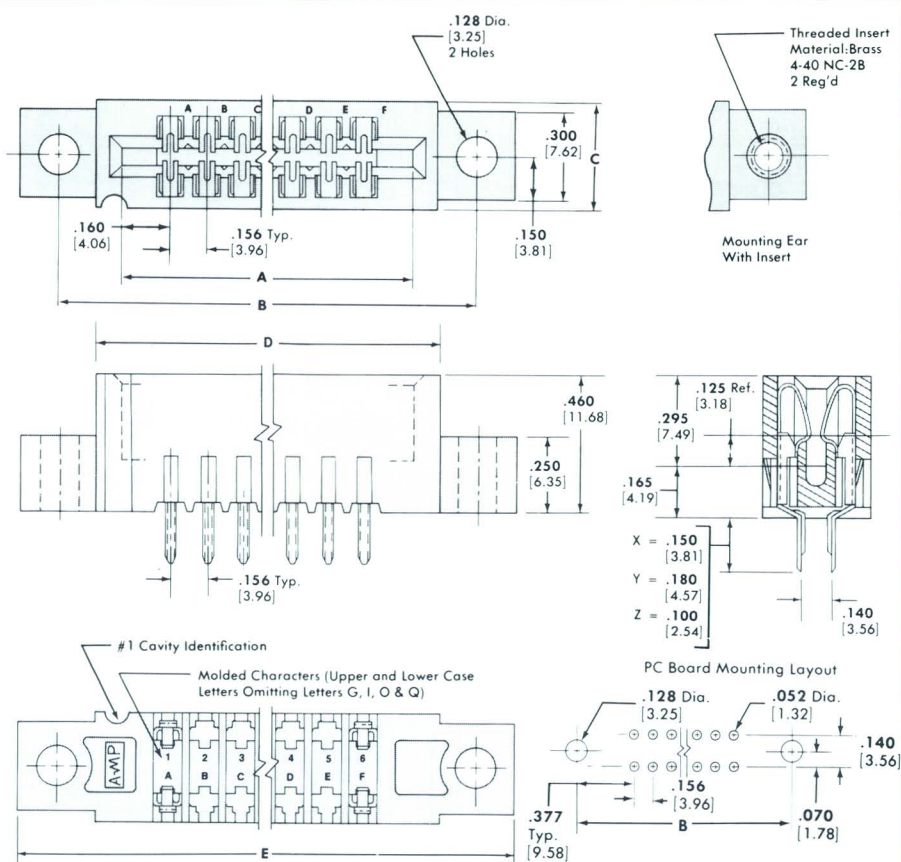

No. of Dual Positions	A	B*	C	D	E*	Post Length	Part Numbers					
							Mounting Ears		Mounting Ears with Inserts		Without Mounting Ears	
							.000015 Gold [0.00038]	.000030 Gold [0.00076]	.000015 Gold [0.00038]	.000030 Gold [0.00076]	.000015 Gold [0.00038]	.000030 Gold [0.00076]
6	1.100 27.94	1.535 38.99	.370 9.4	1.240 31.5	1.785 45.34	X	530657-1	2-530657-1	530679-1	2-530679-1	530668-1	2-530668-1
						Y	530658-1	2-530658-1	530680-1	2-530680-1	530669-1	2-530669-1
10	1.724 43.79	2.159 54.84	.370 9.4	1.864 47.35	2.409 61.19	X	530657-2	2-530657-2	530679-2	2-530679-2	530668-2	2-530668-2
						Y	530658-2	2-530658-2	530680-2	2-530680-2	530669-2	2-530669-2
						Z	530694-4	—	—	—	—	—
12	2.036 51.71	2.471 62.76	.370 9.4	2.176 55.27	2.721 69.11	X	530657-3	2-530657-3	530679-3	2-530679-3	530668-3	2-530668-3
						Y	530658-3	2-530658-3	530680-3	2-530680-3	530669-3	2-530669-3
						Z	530694-5	—	—	—	—	—
15	2.504 63.6	2.939 74.65	.370 9.4	2.644 67.16	3.189 81	X	530657-4	2-530657-4	530679-4	2-530679-4	530668-4	2-530668-4
						Y	530658-4	2-530658-4	530680-4	2-530680-4	530669-4	2-530669-4
						Z	530694-5	—	—	—	—	—
18	2.972 75.49	3.407 86.54	.370 9.4	3.112 79.04	3.657 92.89	X	530657-5	2-530657-5	530679-5	2-530679-5	530668-5	2-530668-5
						Y	530658-5	2-530658-5	530680-5	2-530680-5	530669-5	2-530669-5
						Z	530694-1	—	—	—	—	—
22	3.596 91.34	4.031 102.39	.370 9.4	3.736 94.89	4.281 108.74	X	530657-6	2-530657-6	530679-6	2-530679-6	530668-6	2-530668-6
						Y	530658-6	2-530658-6	530680-6	2-530680-6	530669-6	2-530669-6
						Z	530694-2	—	—	—	—	—
24	3.908 99.26	4.343 110.31	.370 9.4	4.048 102.82	4.593 116.66	X	530657-7	2-530657-7	530679-7	2-530679-7	530668-7	2-530668-7
						Y	530658-7	2-530658-7	530680-7	2-530680-7	530669-7	2-530669-7
25	4.064 103.23	4.499 114.27	.370 9.4	4.204 106.78	4.749 120.62	X	530657-8	2-530657-8	530679-8	2-530679-8	530668-8	2-530668-8
						Y	530658-8	2-530658-8	530680-8	2-530680-8	530669-8	2-530669-8
28	4.532 115.11	4.967 126.16	.370 9.4	4.672 118.67	5.217 132.51	X	1-530657-2	3-530657-2	1-530679-2	3-530679-2	1-530668-2	3-530668-2
						Y	1-530658-2	3-530658-2	1-530680-2	3-530680-2	1-530669-2	3-530669-2
30	4.844 123.04	5.279 134.09	.437 11.1	4.984 126.59	5.529 140.44	X	530657-9	2-530657-9	530679-9	2-530679-9	530668-9	2-530668-9
						Y	530658-9	2-530658-9	530680-9	2-530680-9	530669-9	2-530669-9
36	5.780 146.18	6.215 157.86	.437 11.1	5.920 150.37	6.465 164.21	X	1-530657-0	3-530657-0	1-530679-0	3-530679-0	1-530668-0	3-530668-0
						Y	1-530658-0	3-530658-0	1-530680-0	3-530680-0	1-530669-0	3-530669-0
						Z	530694-3	—	—	—	—	—
43	6.872 174.55	7.307 185.6	.437 11.1	7.012 178.1	7.557 191.95	X	1-530657-3	3-530657-3	1-530679-3	3-530679-3	1-530668-3	3-530668-3
						Y	1-530658-3	3-530658-3	1-530680-3	3-530680-3	1-530669-3	3-530669-3
						Z	530694-6	—	—	—	—	—
44	7.028 178.51	7.463 189.56	.437 11.1	7.168 182.07	7.713 196.91	X	1-530657-1	3-530657-1	1-530679-1	3-530679-1	1-530668-1	3-530668-1
						Y	1-530658-1	3-530658-1	1-530680-1	3-530680-1	1-530669-1	3-530669-1

*These dimensions do not apply to connectors without mounting ears. **Refer to I.S.7772 for contact replacement instructions.

.156 [3.96] Contact Centerline Spacing

Dimensioning:

1. All dimensions in inches and millimetres. Values in brackets are metric equivalents.
2. Charts contain dimensions in inches over millimetres.

Single Readout Solder Post for .052 [1.32] Dia. Hole

Material:

Housing—Glass filled polyester, green
 Contact—Phosphor bronze; Selective Plating—
 .000015 [0.00038] or .000030 [0.00076] min. gold over .000030 [0.00076] min. nickel, contact area; .000150 [0.00381] min. bright tin, post area.
 P.C. board thickness—.055-.070 [1.4-1.78]

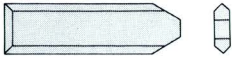

Inter Contact Keying Plug
 Part Number: 530687-1
 Glass filled Nylon

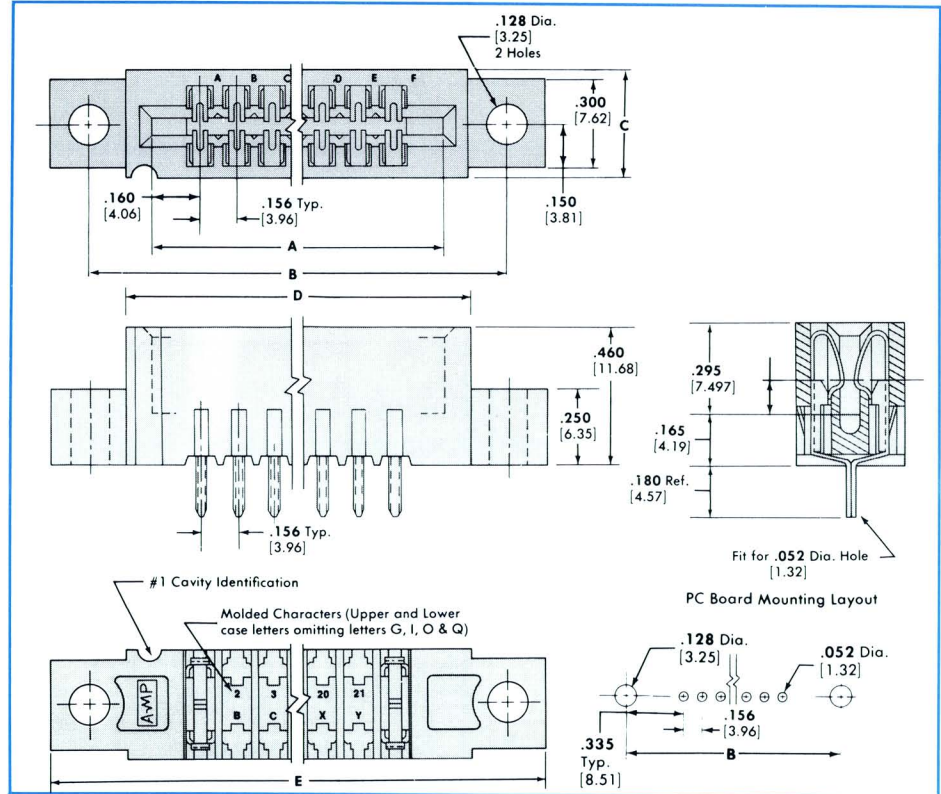

No. of Dual Positions	Part Numbers								
	A	B*	C	D	E*	Mounting Ears		Without Mounting Ears	
						.000015 Gold [0.00038]	.000030 Gold [0.00076]	.000015 Gold [0.00038]	.000030 Gold [0.00076]
6	1.100 27.94	1.535 38.99	.370 9.4	1.240 31.5	1.785 45.34	530692-1	2-530692-1	530693-1	2-530692-1
8	1.412 35.86	1.847 46.91	.370 9.4	1.552 39.42	2.097 53.26	1-530692-4	3-530692-4	1-530693-4	3-530693-4
10	1.724 43.79	2.159 54.84	.370 9.4	1.864 47.35	2.409 61.19	530692-2	2-530692-2	530693-2	2-530693-2
12	2.036 51.71	2.471 62.76	.370 9.4	2.176 55.27	2.721 69.11	530692-3	2-530692-3	530693-3	2-530693-3
15	2.504 63.60	2.939 74.65	.370 9.4	2.644 67.16	3.189 81.	530692-4	2-530692-4	530693-4	2-530693-4
18	2.972 75.49	3.407 86.54	.370 9.4	3.112 79.04	3.657 92.89	530692-5	2-530692-5	530693-5	2-530693-5
22	3.596 91.34	4.031 102.39	.370 9.4	3.736 94.89	4.281 108.74	530692-6	2-530692-6	530693-6	2-530693-6
24	3.908 99.26	4.343 110.31	.370 9.4	4.048 102.82	4.593 116.66	530692-7	2-530692-7	530693-7	2-530693-7
25	4.064 103.23	4.499 114.27	.370 9.4	4.204 106.78	4.749 120.62	530692-8	2-530692-8	530693-8	2-530693-8
28	4.532 115.11	4.967 126.16	.370 9.4	4.672 118.67	5.217 132.51	1-530692-2	3-530692-2	1-530693-2	3-530693-2
30	4.844 123.04	5.279 134.09	.437 11.1	4.984 126.59	5.529 140.44	530692-9	2-530692-9	530693-9	2-530693-9
36	5.780 146.18	6.215 157.86	.437 11.1	5.920 150.37	6.465 164.21	1-530692-0	3-530692-0	1-530693-0	3-530693-0
43	6.872 174.55	7.307 185.6	.437 11.1	7.012 178.1	7.557 191.95	1-530692-3	3-530692-3	1-530693-3	3-530693-3
44	7.028 178.51	7.463 189.56	.437 11.1	7.168 182.07	7.713 196.91	1-530692-1	3-530692-1	1-530693-1	3-530693-1

* These dimensions do not apply to connectors without mounting ears.

.156 [3.96] Contact Centerline Spacing

Dimensioning:

- All dimensions in inches and millimetres. Values in brackets are metric equivalents.
- Charts contain dimensions in inches over millimetres.

Solder Eyelet

Material:

Housing—Glass filled polyester, green
Contact—Phosphor bronze; Selective
Plating—

.000015 [0.00038] or .000030 [0.00076]
min. gold over .000030 [0.00076] min.
nickel, contact area; .000150 [0.00381]
min. bright tin, post area.

P.C. board thickness—.055-.070 [1.4-
1.78]

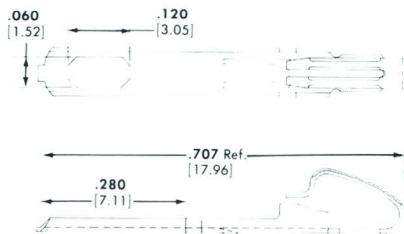

Replacement Contact*

Part Number: 1-530650-2

Selective Plating—.000030 [0.00076]

Min. gold



Inter Contact Keying Plug

Part Number: 530687-1

Glass filled Nylon

*Refer to I.S.772 for contact replacement instructions.

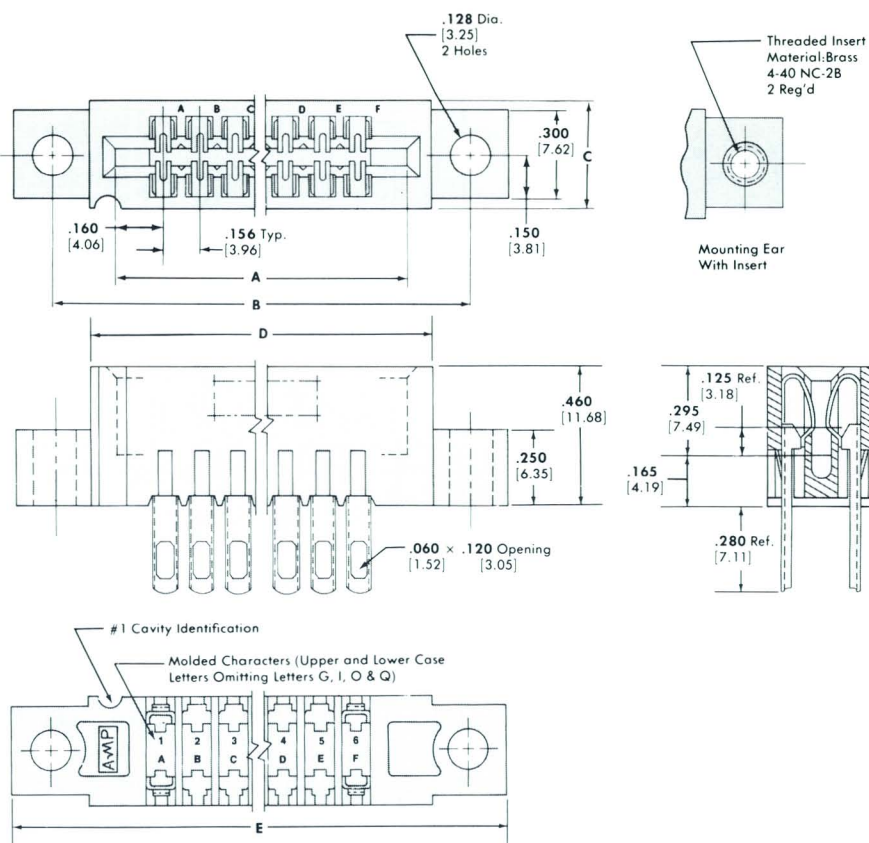

No. of Dual Positions	A	B	C	D	E	Part Numbers			
						Mounting Ears		Mounting Ears with Inserts	
						.000015 Gold [0.00038]	.000030 Gold [0.00076]	.000015 Gold [0.00038]	.000030 Gold [0.00076]
6	1.100 27.94	1.535 38.99	.370 9.4	1.240 31.5	1.785 45.34	530654-1	2-530654-1	530676-1	2-530676-1
10	1.724 43.79	2.159 54.84	.370 9.4	1.864 47.35	2.409 61.19	530654-2	2-530654-2	530676-2	2-530676-2
12	2.036 51.71	2.471 62.76	.370 9.4	2.176 55.27	2.721 69.11	530654-3	2-530654-3	530676-3	2-530676-3
15	2.504 63.6	2.939 74.65	.370 9.4	2.644 67.16	3.189 81	530654-4	2-530654-4	530676-4	2-530676-4
18	2.972 75.49	3.407 86.54	.370 9.4	3.112 79.04	3.657 92.89	530654-5	2-530654-5	530676-5	2-530676-5
22	3.596 91.34	4.031 102.39	.370 9.4	3.736 94.89	4.281 108.74	530654-6	2-530654-6	530676-6	2-530676-6
24	3.908 99.26	4.343 110.31	.370 9.4	4.048 102.82	4.593 116.66	530654-7	2-530654-7	530676-7	2-530676-7
25	4.064 103.23	4.499 114.27	.370 9.4	4.204 106.78	4.749 120.62	530654-8	2-530654-8	530676-8	2-530676-8
28	4.532 115.11	4.967 126.16	.370 9.4	4.672 118.67	5.217 132.51	1-530654-2	3-530654-2	1-530676-2	3-530676-2
30	4.844 123.04	5.279 134.09	.437 11.1	4.984 126.59	5.529 140.44	530654-9	2-530654-9	530676-9	2-530676-9
36	5.780 146.18	6.215 157.86	.437 11.1	5.920 150.37	6.465 164.21	1-530654-0	3-530654-0	1-530676-0	3-530676-0
43	6.872 174.55	7.307 185.6	.437 11.1	7.012 178.1	7.557 191.95	1-530654-3	3-530654-3	1-530676-3	3-530676-3
44	7.028 178.51	7.463 189.56	.437 11.1	7.168 182.07	7.713 196.91	1-530654-1	3-530654-1	1-530676-1	3-530676-1

.156 [3.96] Contact Centerline Spacing

Dimensioning:

- All dimensions in inches and millimetres. Values in brackets are metric equivalents.
- Charts contain dimensions in inches over millimetres.

.200 [5.08] Row to Row Spacing Solder Post for .040 [1.02] Dia. Hole

Material:

Housing—Glass filled polyester, green
 Contact—Phosphor bronze; Selective Plating—.000015 [0.00038] or .000030 [0.00076] min. gold over .000030 [0.00076] min. nickel, contact area; .000150 [0.00381] min. bright tin, post area.
 P.C. board thickness—.055-.070 [1.4-1.78]

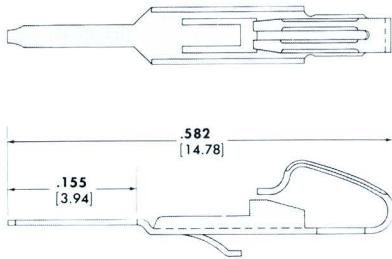

Replacement Contact*

Part Number: 1-530688-2
 Selective Plating—.000030 [0.00076] min. gold



Inter Contact Keying Plug

Part Number: 530687-1
 Glass filled Nylon

*Refer to I.S.772 for contact replacement instructions.

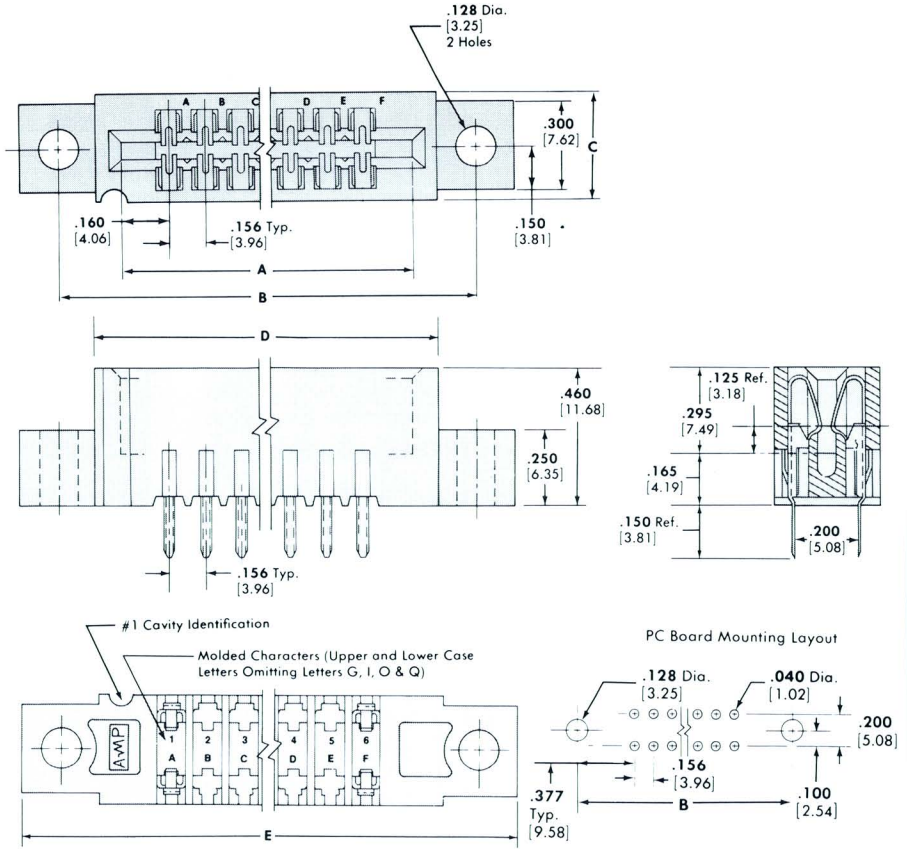

No. of Dual Positions	Dimensions (A, B, C, D, E)					Part Number	
						Mounting Ears	
						.000015 Gold [0.00038]	.000030 Gold [0.00076]
6	1.100 27.94	1.535 38.99	.370 9.4	1.240 31.5	1.785 45.34	530689-1	2-530689-1
10	1.724 43.79	2.159 54.84	.370 9.4	1.864 47.35	2.409 61.19	530689-2	2-530689-2
12	2.036 51.71	2.471 62.76	.370 9.4	2.176 55.27	2.721 69.11	530689-3	2-530689-3
15	2.504 63.6	2.939 74.65	.370 9.4	2.644 67.16	3.189 81	530689-4	2-530689-4
18	2.972 75.49	3.407 86.54	.370 9.4	3.112 79.04	3.657 92.89	530689-5	2-530689-5
22	3.596 91.34	4.031 102.39	.370 9.4	3.736 94.89	4.281 108.74	530689-6	2-530689-6
24	3.908 99.26	4.343 110.31	.370 9.4	4.048 102.82	4.593 116.66	530689-7	2-530689-7
25	4.064 103.22	4.499 114.27	.370 9.4	4.204 106.78	4.749 120.62	530689-8	2-530689-8
28	4.532 115.11	4.967 126.16	.370 9.4	4.672 118.67	5.217 132.51	1-530689-2	3-530689-2
30	4.844 123.04	5.279 134.09	.437 11.1	4.984 126.59	5.529 140.44	530689-9	3-530689-9
36	5.780 146.81	6.215 157.86	.437 11.1	5.920 150.37	6.465 164.21	1-530689-0	3-530689-0
43	6.872 174.55	7.307 185.6	.437 11.1	7.012 178.1	7.557 191.95	1-530689-3	3-530689-3
44	7.028 178.51	7.463 189.56	.437 11.1	7.168 182.07	7.713 195.91	1-530689-1	3-530689-1

.156 [3.96] Contact Centerline Spacing

Dimensioning:

- All dimensions in inches and millimetres. Values in brackets are metric equivalents.
- Charts contain dimensions in inches over millimetres.

.200 [5.08] Row to Row Spacing Solder Post for .052 [1.32] Dia. Hole Card Slot Depth—.333 [8.46]

Material:

Housing—Glass filled polyester, green

Contact—Phosphor bronze; Selective

Plating—

.000015 [0.00038] or .000030 [0.00076]

min. gold over .000030 [0.00076] min.

nickel, contact area; .000150 [0.00381]

min. bright tin, post area.

P.C. board thickness—.055-.070 [1.4-

1.78]

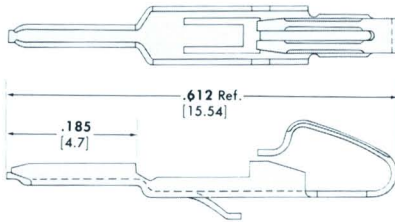

Replacement Contact*

Part Number: 1-530651-4

Selective Plating—.000030 [0.00076]

min. gold

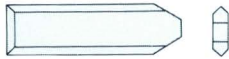

Inter Contact Keying Plug

Part Number: 530687-1

Glass filled Nylon

*Refer to I.S.7772 for contact replacement instructions.

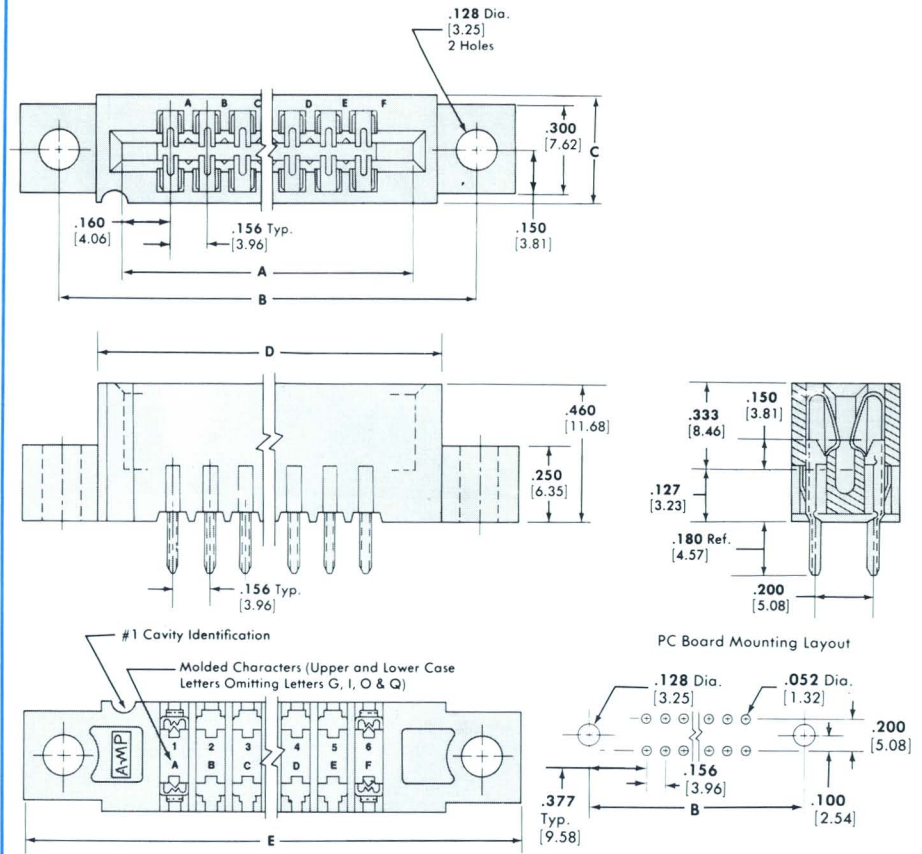

No. of Dual Positions	A	B	C	D	E	Part Numbers	
						Mounting Ears	
						.000015 Gold [0.00038]	.000030 Gold [0.00076]
6	1.100 27.94	1.535 38.99	.370 9.4	1.240 31.5	1.785 45.34	530691-1	2-530691-1
10	1.724 43.79	2.159 54.84	.370 9.4	1.864 47.35	2.409 61.19	530691-2	2-530691-2
12	2.036 51.71	2.471 62.76	.370 9.4	2.176 55.27	2.721 69.11	530691-3	2-530691-3
15	2.504 63.6	2.939 74.65	.370 9.4	2.644 67.16	3.189 81	530691-4	2-530691-4
18	2.972 75.49	3.407 86.54	.370 9.4	3.112 79.04	3.657 92.89	530691-5	2-530691-5
22	3.596 91.34	4.031 102.39	.370 9.4	3.736 94.89	4.281 108.74	530691-6	2-530691-6
24	3.908 99.26	4.343 110.31	.370 9.4	4.048 102.82	4.593 116.66	530691-7	2-530691-7
25	4.064 103.23	4.499 114.27	.370 9.4	4.204 106.78	4.749 120.62	530691-8	2-530691-8
28	4.532 115.11	4.967 126.16	.370 9.4	4.672 118.67	5.217 132.51	1-530691-2	3-530691-2
30	4.844 123.04	5.279 134.09	.437 11.1	4.984 126.59	5.529 140.44	530691-9	2-530691-9
36	5.780 146.81	6.215 157.86	.437 11.1	5.920 150.37	6.465 164.21	1-530691-0	3-530691-0
43	6.872 174.55	7.307 185.6	.437 11.1	7.012 178.1	7.557 191.95	1-530691-3	3-530691-3
44	7.028 178.51	7.463 189.56	.437 11.1	7.168 182.07	7.713 195.91	1-530691-1	3-530691-1

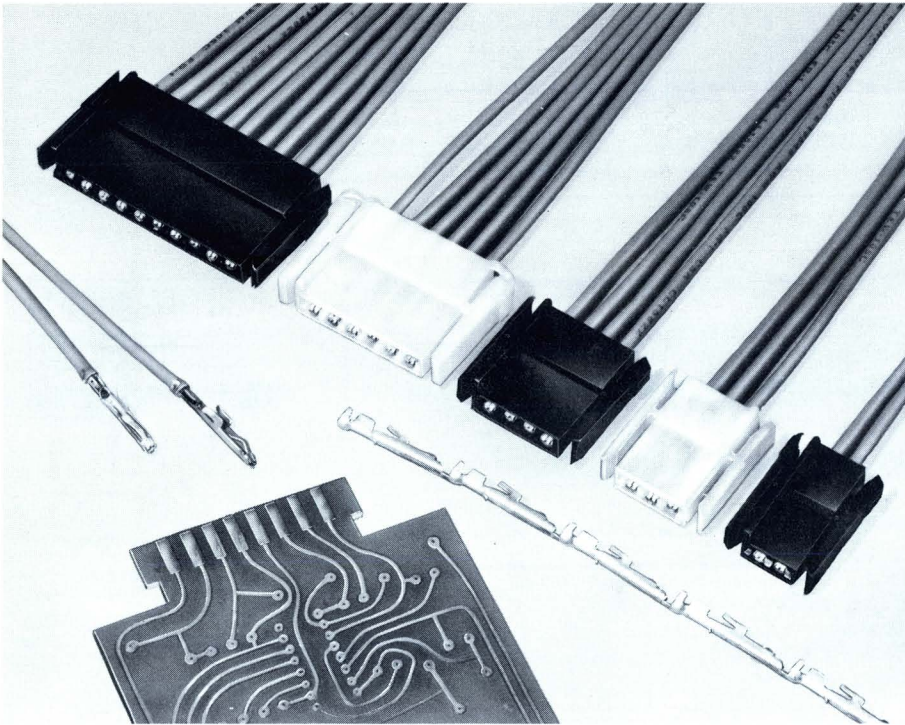

The rapid trend toward modularization and use of printed circuitry today has created the need for new, compatible interconnection concepts. One example that fulfills many such industry demands is the AMP Commercial Printed Circuit Board Connector. This multi-position card edge connector is designed for connecting directly to a .062" thick pc board and provides fast, reliable electrical connections for a multitude of commercial applications. In fact, it can be used virtually anywhere there's a need for connecting printed circuit boards.

Connector housings are available in sizes ranging from 2 to 10 circuits and with contact cavities on .175" centers. They are molded from durable nylon material and incorporate many design features to assure easy, low cost installation as well as optimum electrical and mechanical reliability. Included are: internal keying webs and

external polarizing ribs which assure proper connector/pc board mating, even in "blind area" installation; color coding for accurate identification; and a self-locking design for positive retention to plastic and metal shrouds and to the pc boards themselves.

The connector contacts are stamped and formed from an aluminum-bronze alloy and feature a leaf-type design which provides firm wiping action and sustained contact mating pressure for maximum electrical conductivity. They can be crimped to a wide range of wire sizes, from #20 to 16 AWG, and can accommodate insulation diameters up to .132". Individual contacts simply snap into the housings, requiring no special tools for insertion, yet are removable for circuit changes or repair. AMP supplies these contacts on reel-stored strips for their economical, high speed attachment to wire using automatic terminating machines.

AMP Commercial Printed Circuit Board Connector

Features

- Leaf-type contact design provides firm wiping action and sustained contact pressure for positive electrical connection
- Crimp contacts accept a #20 to 16 AWG wire range—no soldering required
- Contacts snap into housings without special tools for insertion
- Contacts fabricated from aluminum-bronze alloy with tin plating—other finishes available upon request
- Contacts housed on .175" centers and can be easily removed for circuit changes or repair
- Durable nylon housings with self-locking design
- Housings accommodate full range of .062" thick boards
- High-speed automatic machine terminations assure maximum reliability at the lowest possible applied cost

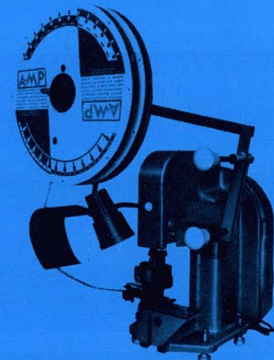

The AMP-O-LECTRIC Automatic Terminating Machine applies contacts to wire at rates up to 4,000 an hour. It uses standard miniature applicators with precision dies to assure uniform terminations. All adjustments are made rapidly; crimping height on both wire barrel and insulation support for a given wire size is simply "dialed in". Other types of high-speed application equipment are also available.

Specifications

Housings
(for .062 thick pc boards)

Contacts

Wire Range: #20-16 AWG
Insulation Diameter: .132 max.
Current Rating: 5 amperes

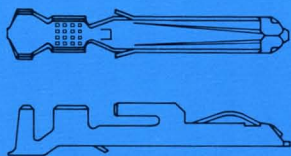

Material: Aluminum-bronze alloy
Finish: Tin—other finishes available
Part Number: 61709-1

Note: All dimensions in inches.

Specifications subject to change.
Consult AMP Incorporated for latest design specifications.

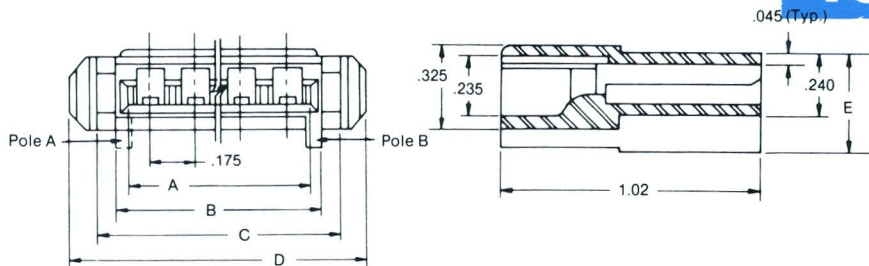

2, 3 & 4 Circuit Housings

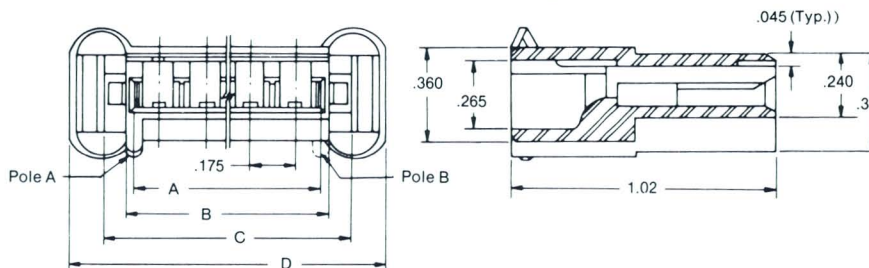

5 & 6 Circuit Housings

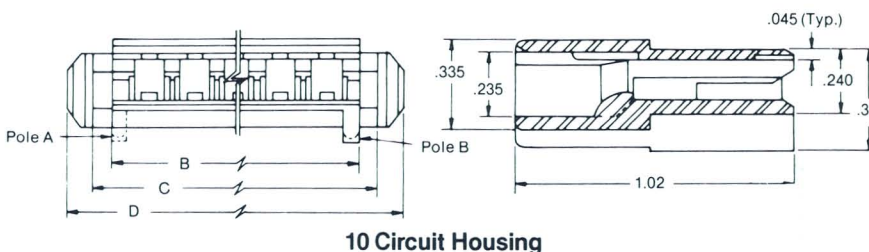

10 Circuit Housing

Material: Type 6/6 Nylon

No. of Circuits	Pole	Dimensions					Color	Part No.
		A	B	C	D	E		
2	B	.355	.435	.570	.770	.380	Natural	1-480528-0
							Black	1-480528-1
	B	.355	.435	.570	.770	.340	Natural	520014-1
							Red	520014-2
3	A	.530	.610	.750	.950	.380	Natural	1-480530-0
							Black	1-480530-1
	B	.530	.610	.750	.950	.380	Natural	1-480531-0
							Black	1-480531-1
4	B	.705	.780	.925	1.120	.380	Natural	1-480529-0
	B						Black	1-480529-1
5	A	1.055	1.150	1.285	1.600	.380	Natural	520001-1*
	A						Red	520001-2*
6	B	1.055	1.150	1.285	1.600	.380	Natural	1-480562-0
10	B	—	1.835	1.975	2.170	.380	Black	520024-1

*Circuit No. 6, cavity farthest from Pole A, is blocked.

Notes:

1. All housings can be supplied with either Pole A, Pole B or other desired polarization.
2. Housings can be furnished with one or two internal key webs (located between circuits in the connector) for pc board keying.
3. Additional housing colors are available.

Typical Connector Mating Applications

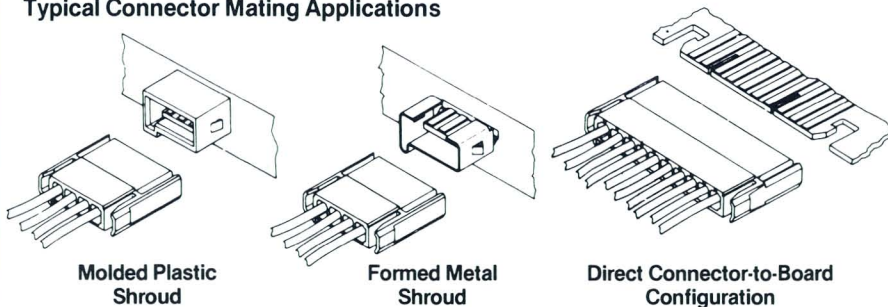

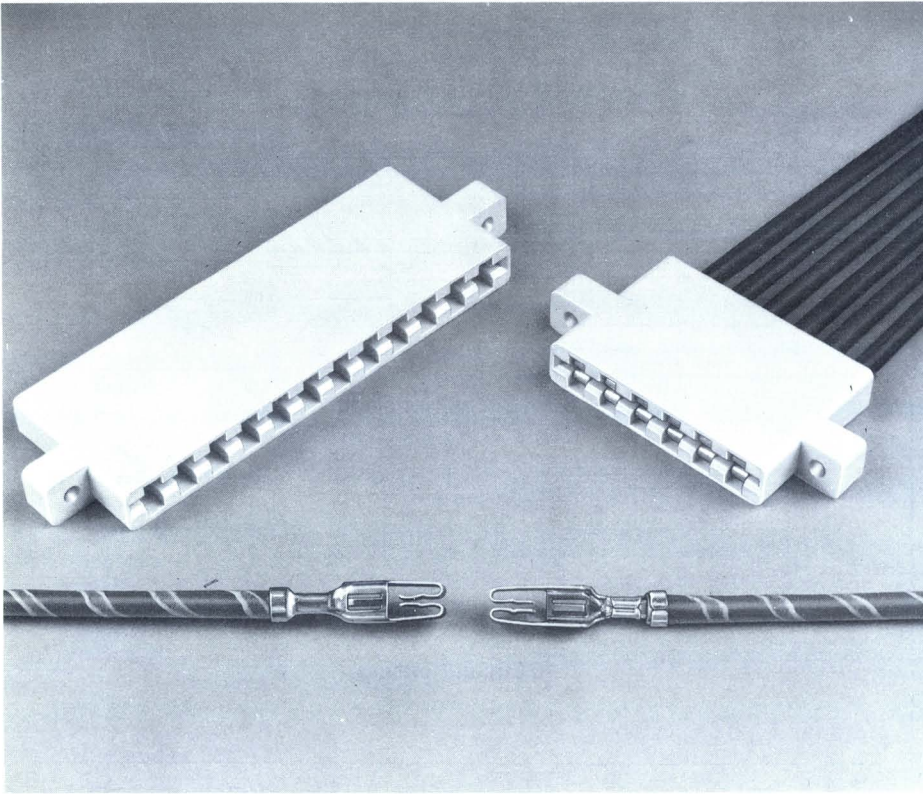

AMP High Current Edge Connector

Features

- High current capability — up to 30 amps
- Housings of U.L. 94V-0 rated glass reinforced thermoplastic
- Choice of 2, 3, 4, 5, 6, 8, 9, 10 and 12 position connector transfigurations
- Heavy duty tin over nickel plated high conductivity copper alloy contacts
- Contacts on .312 [7.92] centerlines
- Large redundant area of contact for maximum electrical continuity
- Connector mates with standard .062 [1.57] two-sided printed circuit board
- Contacts available in precision form for automatic machine termination or loose piece for manual tool application
- Optional gold over nickel plated contacts can be made available

Dimensioning:

All dimensions in inches and millimetres.
Values in brackets are metric equivalents.

Specifications subject to change.
Consult AMP Incorporated for the latest design specifications.

The AMP High Current Edge Connector is an economical answer to the costly problem of high current printed circuitry. Designed to accept up to 30 amps, this connector features a U.L. 94V-0 rated, rugged glass reinforced thermoplastic housing with bright tin over nickel plated high conductivity copper alloy contacts on .312 [7.92] centerlines.

Connectors are available in 2, 3, 4, 5, 6, 8, 9, 10 and 12 contact positions. Crimp, snap-in contacts mate with .062 [1.57] two-sided boards have large redundant contact areas and will accept wire size range

from 16 to 10 AWG [1.25 - 6 mm²]. Contacts are available in precision strip form for high speed automatic machine termination or in loose piece for AMP CERTI-CRIMP hand tool termination.

While the basic contact is designed to carry 30 amps, the actual number of contacts in a connector carrying 30 amps is limited by the "T" rise of the connector and printed circuit board. For details on your specific high current edge connector application, contact your local AMP Sales Engineer or AMP Incorporated, Harrisburg, Pa.

Performance Characteristics

Operating Temperature:
-40°C to +95°C

Dielectric Withstanding:
1800 VAC (sea level)

Operating Voltage: 250 VAC (max.)

Insulation Resistance:
1,000 megohms (min.)

Contact Resistance at 30 amp:
2 milliohms (max.)

Specifications

Connector Housing

Materials

Glass filled polyester — white
(U.L. rated 94V-0 flame retardant)

Dimensioning:

1. All dimensions in inches and millimetres. Values in brackets are metric equivalents.
2. Charts contain dimensions in inches over millimetres.

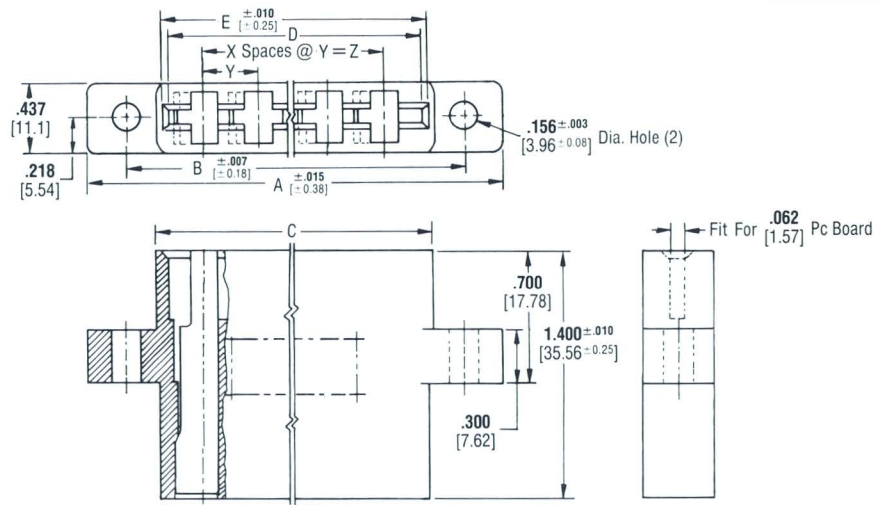

No. of Positions	Dimensions							Part Number	
	A	B	C	D	E	X	Y		Z
2	1.660	1.226	.852	.712	.802	1	.312	.312	530521-1
	42.16	31.14	21.64	18.08	20.37		7.92	7.92	
3	1.972	1.538	1.164	1.024	1.114	2	.312	.624	530521-2
	50.09	39.07	29.57	26.01	28.3		7.92	15.85	
4	2.284	1.850	1.476	1.336	1.426	3	.312	.936	530521-3
	58.01	46.99	37.49	33.93	36.22		7.92	23.77	
5	2.596	2.162	1.788	1.648	1.738	4	.312	1.248	530521-4
	65.94	54.91	45.42	41.86	44.15		7.92	31.7	
6	2.980	2.474	2.100	1.960	2.050	5	.312	1.560	530521-5
	75.69	62.84	53.34	49.78	52.07		7.92	39.62	
8	3.532	3.098	2.724	2.584	2.674	7	.312	2.184	530521-6
	89.71	78.69	69.19	65.63	67.92		7.92	55.47	
9	3.844	3.410	3.036	2.896	2.986	8	.312	2.496	530521-7
	97.64	86.61	77.11	73.56	75.84		7.92	63.4	
10	4.156	3.722	3.348	3.208	3.298	9	.312	2.808	530521-8
	105.56	94.54	85.04	81.48	83.77		7.92	71.32	
12	4.780	4.346	3.972	3.832	3.922	11	.312	3.432	530521-9
	121.41	110.39	100.89	97.33	99.62		7.92	87.17	

Contacts

Materials

Copper alloy CDA-195 with
.000150 [0.00381] bright tin over
.000030 [0.00076] nickel

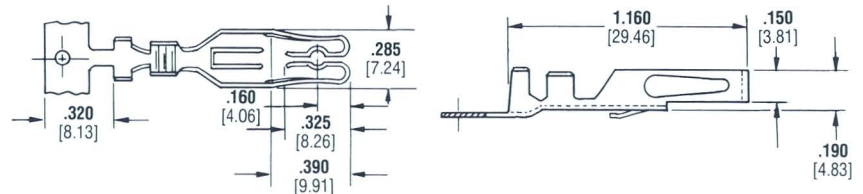

Wire Size Range		Ins. Dia. Range	Contact Part Number		Hand Tool Part Numbers	
AWG	mm ²		Strip Form	Loose Piece	Die Set*	Handle Assembly
16-14	1.25-2	.124-.152	530517-1	530518-1	90333-1	69710-1
		3.15-3.86				
12-10	3-6	.160-.210	530519-1	530520-1	90332-1	
		4.06-5.33				

Contact Extraction Tool No. 91116-1; On-Contact Keying Plug No. 530533-1.
*Die set is installed at the user's location — no special wrenches are required.

Application Tooling

AMP manufactures a full range of automatic and semi-automatic application tooling. Choice of the proper tooling for your production requirements is an important factor in determining your overall cost savings. Consult AMP Incorporated to be assured that you have the right machine for your application.

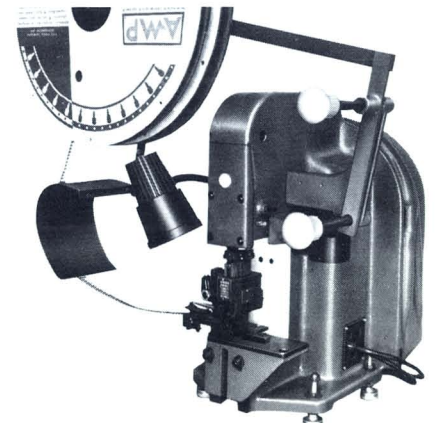

AMP-O-LECTRIC Machine

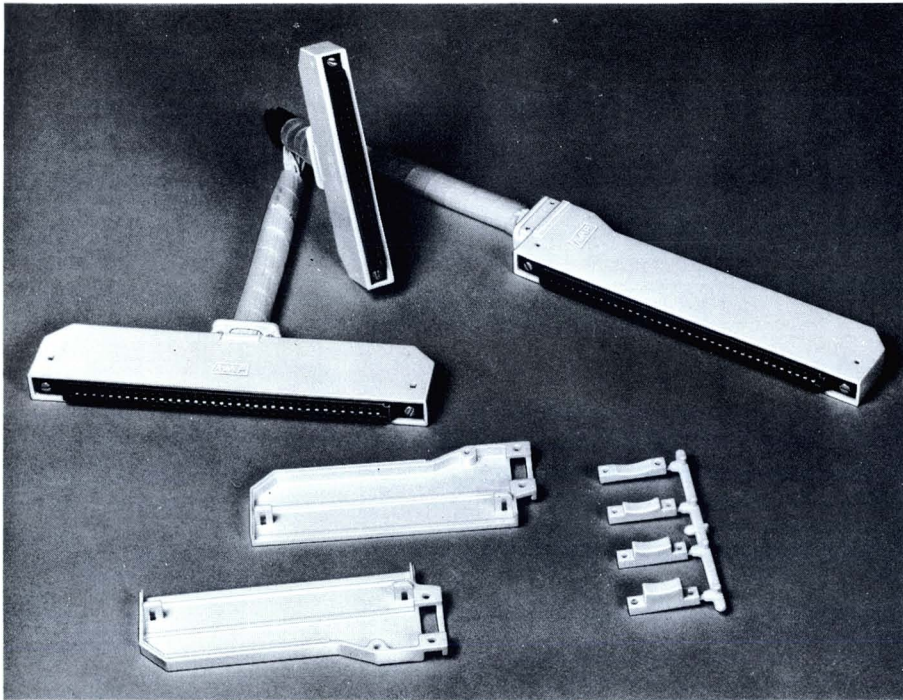

AMP Printed Circuit Connector Hood Assemblies

Features

- Can be used with AMP's highly versatile AMP-LEAF, AMP-TAB and Twin Leaf (Crimp-type) Printed Circuit Edge Connectors
- AMP PC Edge Connectors available in popular sizes:
 - 10 to 36 dual contact positions
 - .100" [2.54], .125" [3.18] and .156" [3.96] contact centers
 - mounting hole centers from 2.160" [54.86] to 6.578" [167.08]
 - widths of .350"/.380" [8.89/9.65] .437 [11.1]
- Clamping capabilities for wire bundles to .550" [13.97] maximum diameter
- Available with 90° or 180° cable outlet
- All plastic construction — thermoplastic material U.L. rated 94V-O for electrical and mechanical applications up to +105°
- Thermoplastic material has excellent resistance to common commercial cleaners when used at moderate temperatures
- Separable hood assembly halves permit easy cable dressing
- Furnished in convenient kit form; each kit includes four cable clamp sizes

For complete details on AMP-LEAF, AMP-TAB and Twin Leaf (Crimp-type) PC Edge Connector families, request:

AMP Data Sheet No. 411-5 (AMP-LEAF Connectors)

AMP Data Sheet No. 74-285 (AMP-TAB Connectors)

AMP Data Sheet No. 74-267 (Twin Leaf Connectors)

Specifications subject to change.
Consult AMP Incorporated for latest design specifications.

Dimensioning:

All dimensions in inches and millimetres.
Values in brackets are metric equivalents.

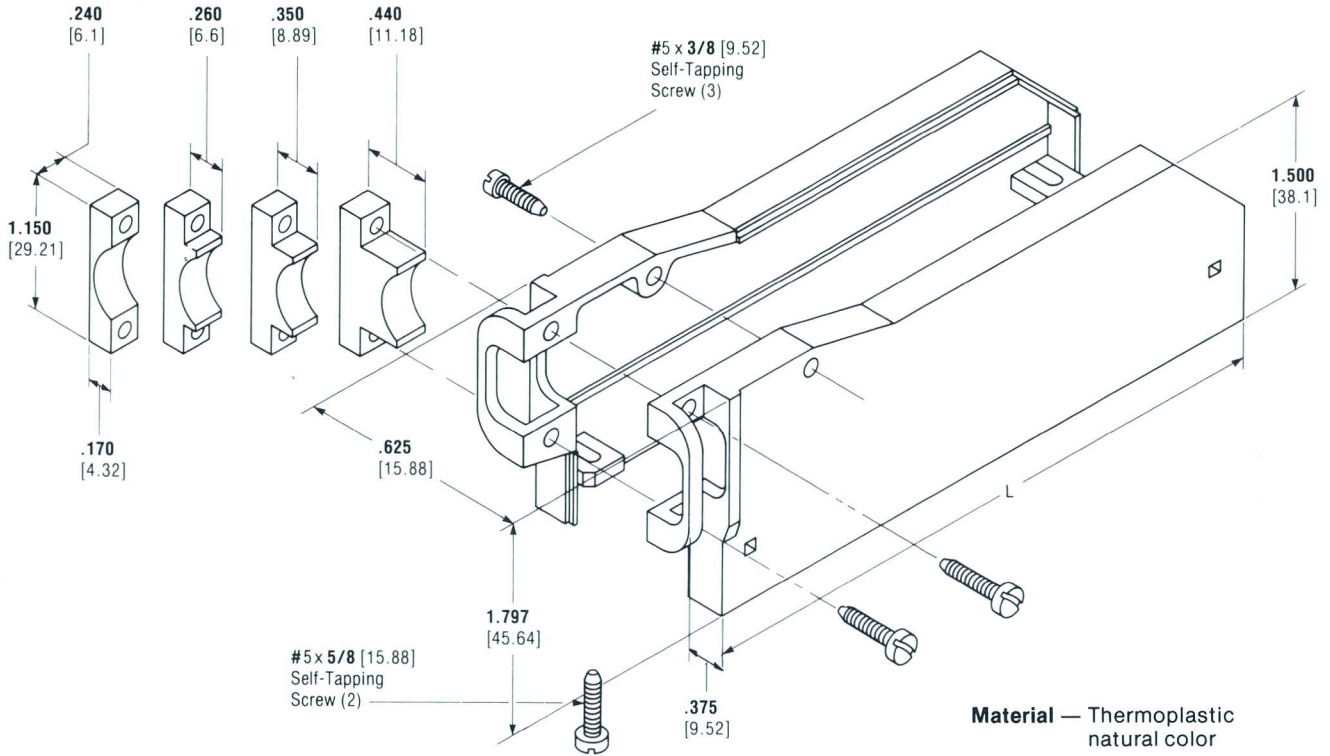

PC Connector Hood Assembly, 90° Cable Outlet

No. of Pos.	Connector Size			Hood L Dim. (Max.)	Connector Width .380 [9.65] Max.		Connector Width .437 [11.1]	
	Contact	Mtg. Hole	Length (Max.)		AMP Connector Family	Hood Assembly Kit No.*	AMP Connector Family	Hood Assembly Kit No.*
10	.156 3.96	2.160 54.86	2.430 61.72	2.580 65.53	AMP-LEAF	530088-1	AMP-TAB, Twin Leaf (Crimp)	1-530088-1
15	.156 3.96	2.938 74.63	3.219 81.77	3.358 85.3	AMP-LEAF (except 480110, 530072, 582147)	530088-2	AMP-TAB, Twin Leaf (Crimp)	1-530088-2
18	.156 3.96	3.406 86.51	3.685 93.6	3.826 97.18	AMP-LEAF (except 582191, 583279, 583731)	530088-3	AMP-TAB, Twin Leaf (Crimp)	1-530088-3
	.125 3.18	2.795 70.99	3.085 78.36	3.215 81.67	—	—	AMP-TAB, Twin Leaf (Crimp)	1-530088-7
22	.156 3.96	4.031 102.39	4.321 109.76	4.451 113.06	AMP-LEAF (except 582535-1)	530088-4	AMP-TAB, Twin Leaf (Crimp)	1-530088-4
	.125 3.18	3.295 83.69	3.585 91.06	3.715 94.37	—	—	AMP-TAB, Twin Leaf (Crimp)	1-530088-8
30	.156 3.96	5.630 143	5.974 151.74	6.100 154.94	—	—	AMP-TAB, AMP-LEAF, Twin Leaf (Crimp)	1-530088-5
36	.156 3.96	6.578 167.08	7.045 178.95	7.198 182.83	—	—	AMP-TAB, AMP-LEAF, Twin Leaf (Crimp)	1-530088-6
	.125 3.18	5.045 128.14	5.325 135.26	5.665 143.9	—	—	Twin Leaf (Crimp)	1-530088-9

*All screws and four sizes of cable clamps are supplied with each kit.

Dimensioning:

All dimensions in inches and millimetres.
Values in brackets are metric equivalents.

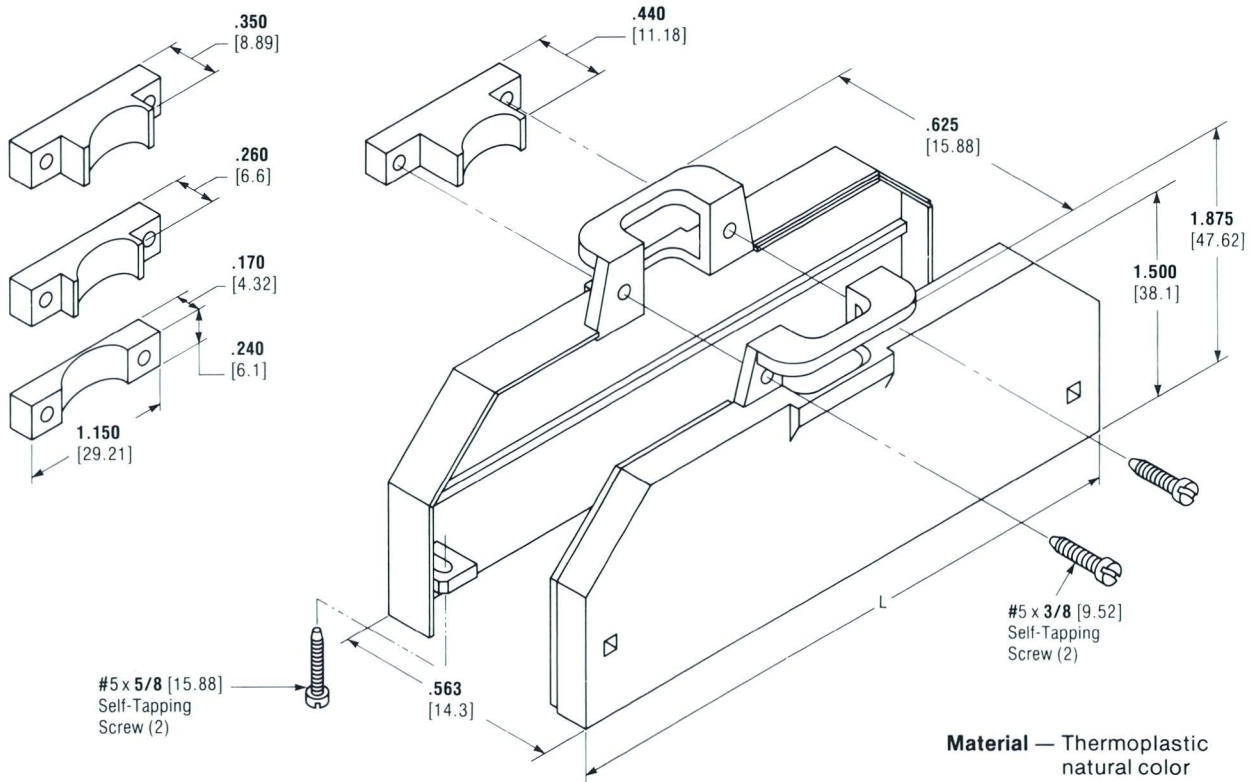

PC Connector Hood Assembly, 180° Cable Outlet

No. of Pos.	Connector Size				Connector Width .380 [9.65] Max.		Connector Width .437 [11.1]	
	Contact	Mtg. Hole	Length (Max.)	Hood L Dim. (Max.)	AMP Connector Family	Hood Assembly Kit No.*	AMP Connector Family	Hood Assembly Kit No.*
10	.156 3.96	2.160 54.86	2.430 61.72	2.580 65.53	AMP-LEAF	530087-1	AMP-TAB, Twin Leaf (Crimp)	1-530087-1
15	.156 3.96	2.938 74.63	3.219 81.77	3.358 85.3	AMP-LEAF (except 480110, 530072, 582147)	530087-2	AMP-TAB, Twin Leaf (Crimp)	1-530087-2
18	.156 3.96	3.406 86.51	3.685 93.6	3.826 97.18	AMP-LEAF (except 582191, 583279, 538731)	530087-3	AMP-TAB, Twin Leaf (Crimp)	1-530087-3
22	.156 3.96	4.031 102.39	4.321 109.76	4.451 113.06	AMP-LEAF (except 582535-1)	530087-4	AMP-TAB, Twin Leaf (Crimp)	1-530087-4
30	.156 3.96	5.630 143	5.974 151.74	6.100 154.94	—	—	AMP-TAB, AMP-LEAF, Twin Leaf (Crimp)	1-530087-5
36	.156 3.96	6.578 167.08	7.045 178.95	7.198 182.83	—	—	AMP-TAB, AMP-LEAF, Twin Leaf (Crimp)	1-530087-6

*All screws and four sizes of cable clamps are supplied with each kit.

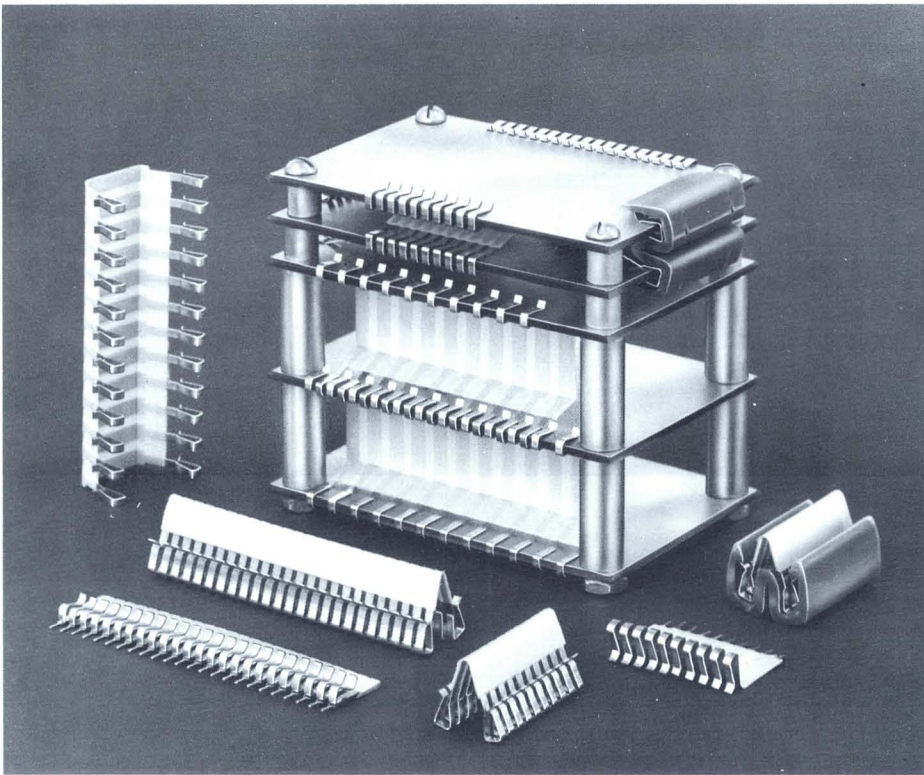

The AMP Laminar Board-to-Board Connectors have been designed with reliability, cost and versatility in mind. The connector system is designed to interconnect parallel mounted printed circuit boards utilizing any of the four edges of the boards. Since the individual contacts engage both sides of the circuit board, conductors on either (or both) sides of the board can be used.

Reliability is realized through contact configuration and design. The individual contact provides sufficient normal force to insure good electrical connection over a wide range of board thickness variations. Deflection designed into the contact

center section allows the connector to follow printed circuit board irregularities (warp, bow, etc.). Since the contact engages both sides of the board, redundant electrical connection is provided in double sided board applications.

Use of an insulating film in place of a conventional molded plastic housing and tin plated contacts provide an economical interconnect system.

AMP Laminar Connectors are presently available to interconnect .062 [1.58] pc boards in configurations from 1 to 50 positions on .100 [2.54] centerlines.

AMP Laminar Board-to-Board Interconnect System

Features

- **Economy** — Insulating Film replaces conventional molded plastic housing. Tin plated contact system.
- **Packaging Versatility** — Connectors for various board spacings available. Connectors of any number of contacts readily achievable.
- **Centerline Flexibility** — Various contact centerlines available.
- **Housing Versions Available** — Plastic housings can be added for applications requiring more rugged connector.
- **Flame Retardant** — Flame retardant film/adhesive system used.
- **Flexible Board Layout** — Conductors on either pc board surface can be used. Redundant contact is provided in two sided board applications utilizing plated thru holes.
- **Application Tooling** — Inexpensive insertion/extraction tools available, when required.

Performance

Current Rating:
3 amperes max.

Termination Resistance:
(.25" [6.35] board separation)
30 milliohms max.

Operating Temperature:
-40°F [-40°C] to 185°F [85°C]

Insulation Resistance:
5000 megohms min. at 500 VDC

Dielectric Withstanding Voltage:
22 ma max. leakage at 1000 vrms

Vibration:

Discontinuities shall not exceed 1 microsecond when subject to 10-55 Hz at .06 [1.52] inch total excursion, mated with printed circuit board.

Humidity:

Unmated, 90-95% RH, 104°F [40°C] for 96 hrs.

For detailed specifications, request AMP Product Specification 108-9040.

All dimensions in inches and millimetres. Values in brackets are metric equivalents.

Specifications subject to change without notice. For latest design drawings contact AMP Incorporated.

Specifications

- Dimensioning:**
- All dimensions in inches and millimetres. Values in brackets are metric equivalents.
 - Chart contains dimensions in inches over millimetres.

.250 [6.35] Board to Board Spacing (.100 [2.54] Center Line) Laminar Connector

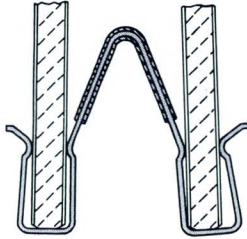

Parallel Installation

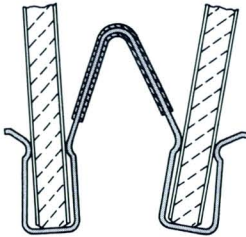

Permits Angle Installation

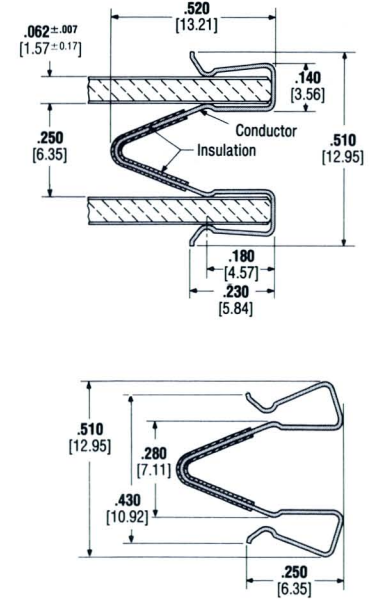
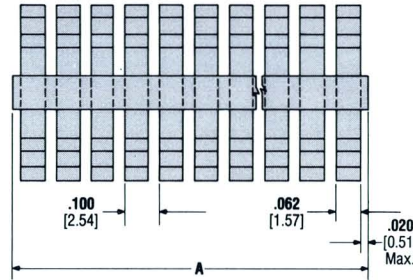

Material: Contacts—Phosphor Bronze, Tin Plated; Insulation—Polyester

No. of Positions	Part Number	A	No. of Positions	Part Number	A
1	530500-1	.100 2.54	26	2-530500-6	2.600 66.04
2	530500-2	.200 5.08	27	2-530500-7	2.700 68.58
3	530500-3	.300 7.62	28	2-530500-8	2.800 71.12
4	530500-4	.400 10.16	29	2-530500-9	2.900 73.66
5	530500-5	.500 12.7	30	3-530500-0	3.000 76.2
6	530500-6	.600 15.24	31	3-530500-1	3.100 78.74
7	530500-7	.700 17.78	32	3-530500-2	3.200 81.28
8	530500-8	.800 20.32	33	3-530500-3	3.300 83.82
9	530500-9	.900 22.86	34	3-530500-4	3.400 86.36
10	1-530500-0	1.000 25.4	35	3-530500-5	3.500 88.9
11	1-530500-1	1.100 27.94	36	3-530500-6	3.600 91.44
12	1-530500-2	1.200 30.48	37	3-530500-7	3.700 93.98
13	1-530500-3	1.300 33.02	38	3-530500-8	3.800 96.52
14	1-530500-4	1.400 35.56	39	3-530500-9	3.900 99.06
15	1-530500-5	1.500 38.1	40	4-530500-0	4.000 101.6
16	1-530500-6	1.600 40.64	41	4-530500-1	4.100 104.14
17	1-530500-7	1.700 43.18	42	4-530500-2	4.200 106.68
18	1-530500-8	1.800 45.72	43	4-530500-3	4.300 109.22
19	1-530500-9	1.900 48.26	44	4-530500-4	4.400 111.76
20	2-530500-0	2.000 50.8	45	4-530500-5	4.500 114.3
21	2-530500-1	2.100 53.34	46	4-530500-6	4.600 116.84
22	2-530500-2	2.200 55.88	47	4-530500-7	4.700 119.38
23	2-530500-3	2.300 58.42	48	4-530500-8	4.800 121.92
24	2-530500-4	2.400 60.96	49	4-530500-9	4.900 124.46
25	2-530500-5	2.500 63.5	50	5-530500-0	5.000 127

Recommended P.C. Board Layout

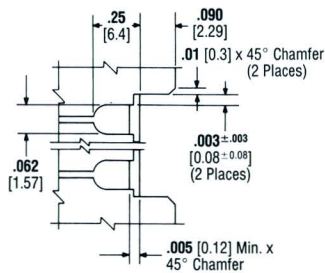

Dimensioning:

1. All dimensions in inches and millimetres. Values in brackets are metric equivalents.
2. Chart contains dimensions in inches over millimetres.

Specifications

**.295 [7.5] Board to Board Spacing
(.100 [2.54] Center Line) Laminar
Connector**

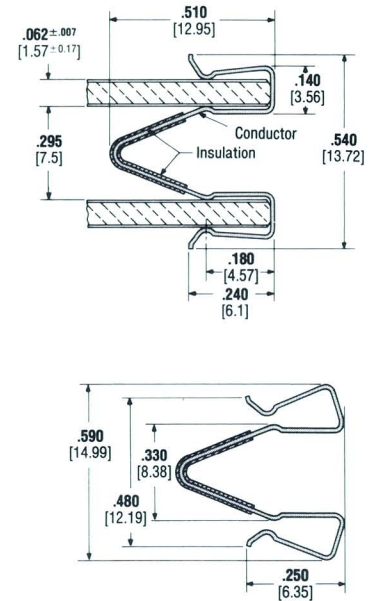
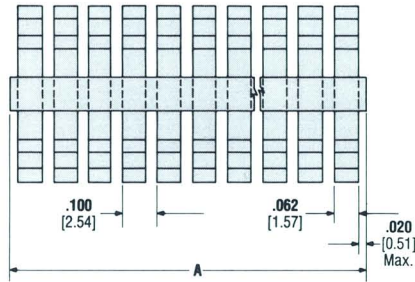

**Typical
Application**

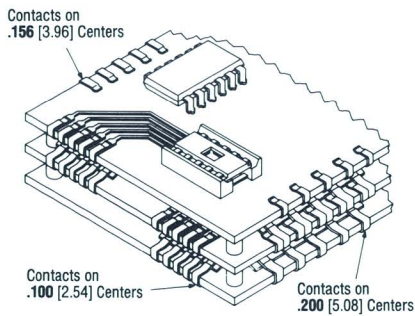

**Recommended
P.C. Board Layout**

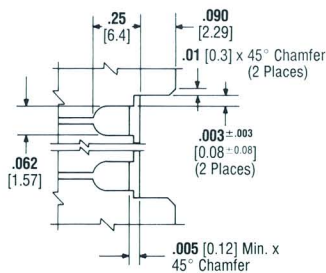

Material: Contacts—Phosphor Bronze, Tin Plated; Insulation—Polyester

No. of Positions	Part Number	A	No. of Positions	Part Number	A
1	530532-1	.100 2.54	26	2-530532-6	2.600 66.04
2	530532-2	.200 5.08	27	2-530532-7	2.700 68.58
3	530532-3	.300 7.62	28	2-530532-8	2.800 71.12
4	530532-4	.400 10.16	29	2-530532-9	2.900 73.66
5	530532-5	.500 12.7	30	3-530532-0	3.000 76.2
6	530532-6	.600 15.24	31	3-530532-1	3.100 78.74
7	530532-7	.700 17.78	32	3-530532-2	3.200 81.28
8	530532-8	.800 20.32	33	3-530532-3	3.300 83.82
9	530532-9	.900 22.86	34	3-530532-4	3.400 86.36
10	1-530532-0	1.000 25.4	35	3-530532-5	3.500 88.9
11	1-530532-1	1.100 27.94	36	3-530532-6	3.600 91.44
12	1-530532-2	1.200 30.48	37	3-530532-7	3.700 93.98
13	1-530532-3	1.300 33.02	38	3-530532-8	3.800 96.52
14	1-530532-4	1.400 35.56	39	3-530532-9	3.900 99.06
15	1-530532-5	1.500 38.1	40	4-530532-0	4.000 101.6
16	1-530532-6	1.600 40.64	41	4-530532-1	4.100 104.14
17	1-530532-7	1.700 43.18	42	4-530532-2	4.200 106.68
18	1-530532-8	1.800 45.72	43	4-530532-3	4.300 109.22
19	1-530532-9	1.900 48.26	44	4-530532-4	4.400 111.76
20	2-530532-0	2.000 50.8	45	4-530532-5	4.500 114.3
21	2-530532-1	2.100 53.34	46	4-530532-6	4.600 116.84
22	2-530532-2	2.200 55.88	47	4-520532-7	4.700 119.38
23	2-530532-3	2.300 58.42	48	4-530532-8	4.800 121.92
24	2-530532-4	2.400 60.96	49	4-530532-9	4.900 124.46
25	2-530532-5	2.500 63.5	50	5-530532-0	5.000 127

Specifications

- Dimensioning:**
- All dimensions in inches and millimetres. Values in brackets are metric equivalents.
 - Chart contains dimensions in inches over millimetres.

.250 [6.35] Board to Board Spacing (.100 [2.54] Center Line) Laminar Connector Assembly

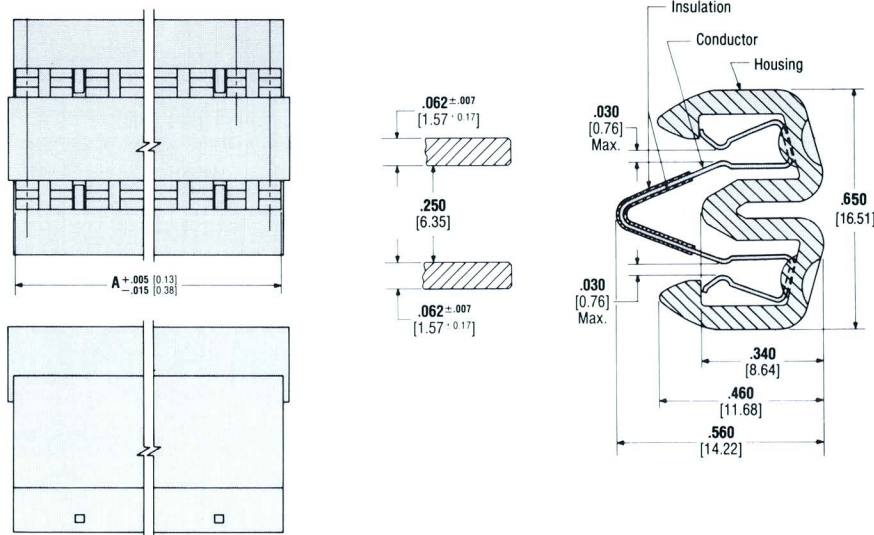

Material: Housing—PVC; Contacts—Phosphor Bronze, Tin Plated; Insulation—Polyester

No. of Positions	Part Number	A	No. of Positions	Part Number	A
5	530537-5	.462 11.73	28	2-530537-8	2.770 70.36
6	530537-6	.562 14.27	29	2-530537-9	2.870 72.9
7	530537-7	.662 16.81	30	3-530537-0	2.970 75.44
8	530537-8	.762 19.35	31	3-530537-1	3.070 77.98
9	530537-9	.862 21.89	32	3-530537-2	3.170 80.52
10	1-530537-0	.962 24.44	33	3-530537-3	3.270 83.06
11	1-530537-1	1.070 27.18	34	3-530537-4	3.370 85.6
12	1-530537-2	1.170 29.72	35	3-530537-5	3.470 88.14
13	1-530537-3	1.270 32.26	36	3-530537-6	3.570 90.68
14	1-530537-4	1.370 34.8	37	3-530537-7	3.670 93.22
15	1-530537-5	1.470 37.34	38	3-530537-8	3.770 95.76
16	1-530537-6	1.570 39.88	39	3-530537-9	3.870 98.3
17	1-530537-7	1.670 42.42	40	4-530537-0	3.970 100.84
18	1-530537-8	1.770 44.96	41	4-530537-1	4.070 103.38
19	1-530537-9	1.870 47.5	42	4-530537-2	4.170 105.92
20	2-530537-0	1.970 50.04	43	4-530537-3	4.270 108.46
21	2-530537-1	2.070 52.58	44	4-530537-4	4.370 111
22	2-530537-2	2.170 55.12	45	4-530537-5	4.470 113.54
23	2-530537-3	2.270 57.66	46	4-530537-6	4.570 116.08
24	2-530537-4	2.370 60.2	47	4-530537-7	4.670 118.62
25	2-530537-5	2.470 62.74	48	4-530537-8	4.770 121.16
26	2-530537-6	2.570 65.28	49	4-530537-9	4.870 123.7
27	2-530537-7	2.670 67.82	50	5-530537-0	4.970 126.24

Recommended P.C. Board Layout

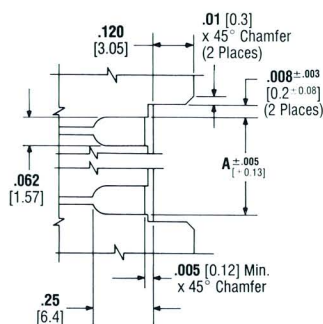

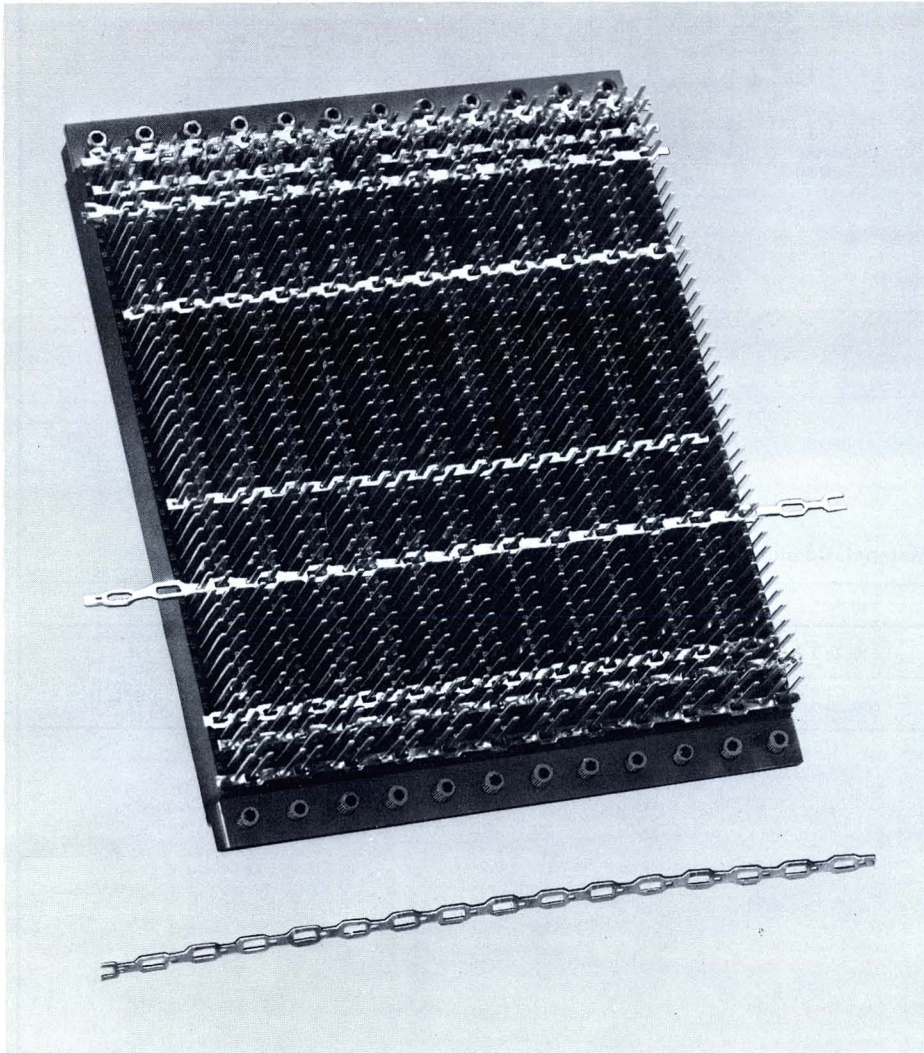

AMP Resistance Soldered Bus Strips provide an effective method of busing terminal posts on connectors or wiring panels. All bus strips are solder coated (one side) and pre-fluxed and are available in lengths from 12" to 18¾" — longer lengths can be made available. Consult AMP Incorporated.

The basic design of the bus strip features two versions for busing .025" and .031" x .062" posts that are quickly and easily installed. Simply select the strip with the number of holes and busing pattern required to meet your application.

Soldering is accomplished by applying power to the end of the bus strip from a suitable power source.

Resistance Soldered Bus Strips

Features

- Solder coated
- Fluxed
- Stackable
- Commons alternating posts or all posts in row
- Air gap insulation around posts not commoned
- After busing, posts will accept TERMI-POINT clip or wrap-type terminations
- Spring pressure and solder joint assures lowest resistance and high reliability
- Equivalent wire size:
 - .020 Thickness = 16 AWG
 - .032 Thickness = 14 AWG

Materials: Copper (QQ-C-576) with 60% tin, 40% lead coating on one side

Finish: Flux coated type RA

For .031 x .062 Posts on .188 to .200 centerlines

Part No. 645008-2

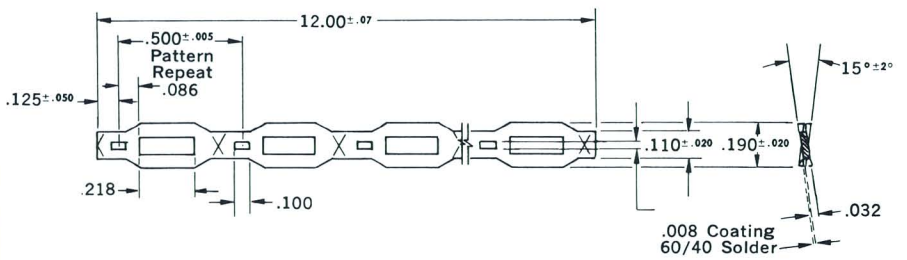

For .025² Posts on .200 to .250 centerlines

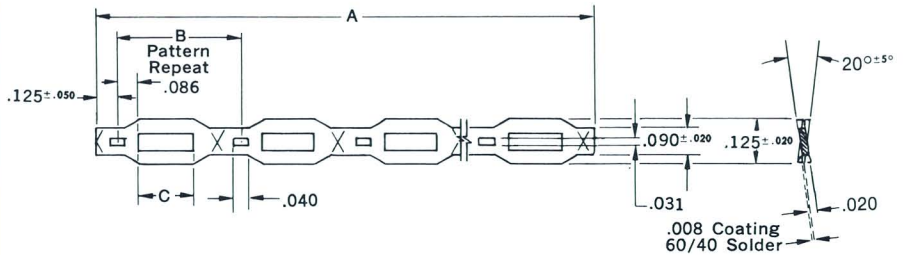

Part No.	Dimensions			Connector Spacing	Post Centerline	Post Size
	C	B	A			
645009-2	.218	.500	12.00 ± .07	.500	.200 to .250	.025 Sq.
1-645009-0	.218	.500	18.00 ± .07	.500	.200 to .250	.025 Sq.
1-645009-8	.318	.600	12.00 ± .07	.600	.200 to .250	.025 Sq.

For .025² Posts on .200 centerlines

Part No. 645018-1

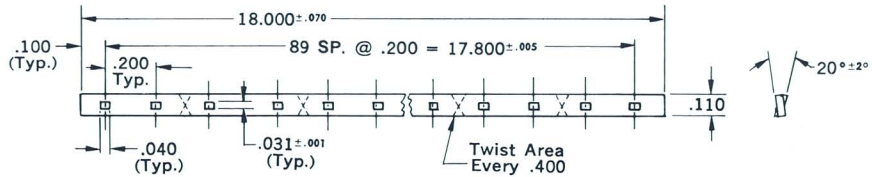

Typical Application

RESISTANCE SOLDERED BUS STRIPS

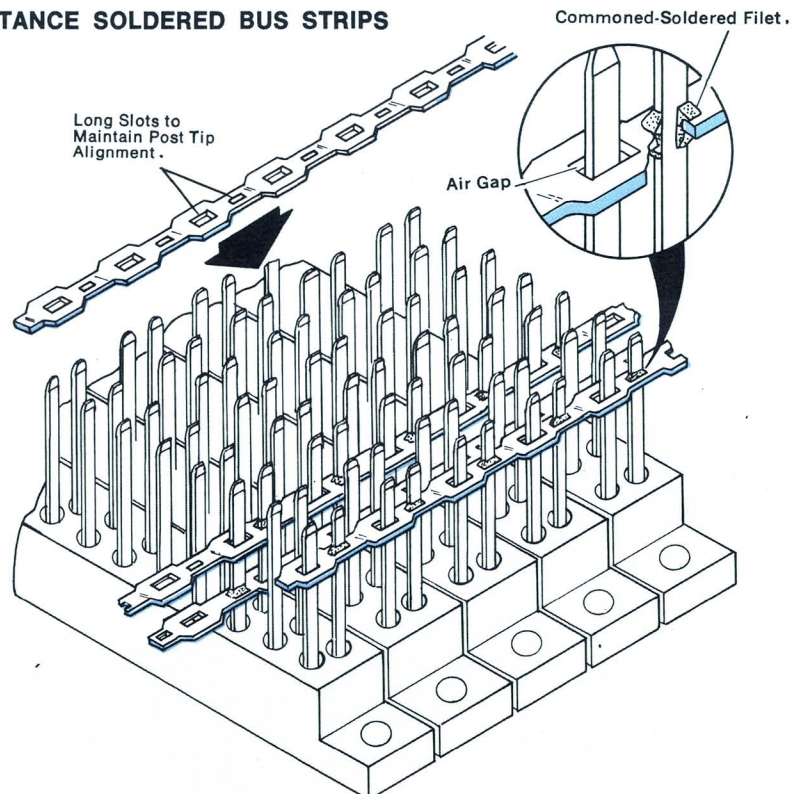

Cross Reference

Commercial MATE-N-LOK Pin and Socket Connectors — Section 9, Pages 19-23 and 19-24. Printed circuit board pin and socket header assemblies. Choice of 2, 3, 4, 6, 8, 10, 12 and 16 circuit configurations. Brass contacts with choice of platings.

Universal MATE-N-LOK Pin and Socket Connectors — Section 9, Pages 9-9 and 9-10. Printed circuit board pin and socket header assemblies. Choice of 2, 3, 4, 6, 9, 12 and 15 circuit configurations. Phosphor bronze contacts with choice of platings.

AMP-LOK General Purpose Connector — Section 6, Pages 6-3 and 6-4. Choice of 3, 4, 6, 9 or 12 circuit configurations. This versatile general purpose connector can easily be adapted for PC header type application.

MR Series Pin and Socket Connectors — Section 9, Pages 9-49 — 9-62. Economical pin and socket connector can be made available for board mount applications.

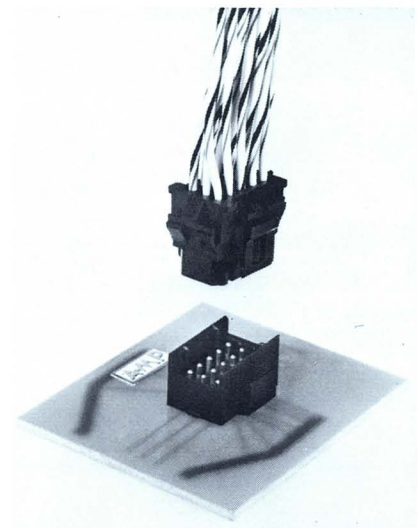
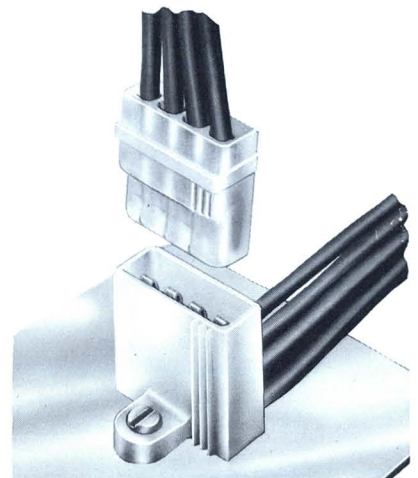
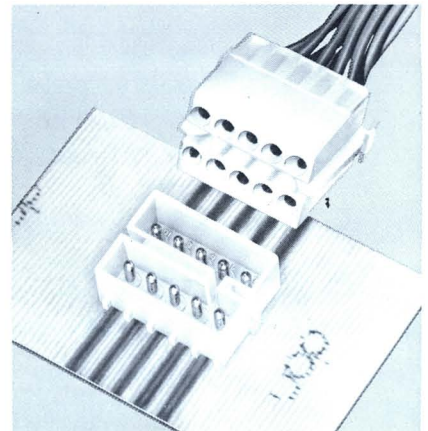

(Continued page 13-71)

Cross Reference (cont.)

M Series Pin and Socket Connectors — Section 9, Pages 9-69 to 9-147. AMP's most popular pin and socket type connector. Design flexibilities allow for quick adaptation to PC applications.

HDR Series Pin and Socket Connectors — Section 9, Pages 9-249 to 9-263. A high density connector with contacts on .100 x .100 true grid. Accommodate wire ranges 30 thru 20 AWG. PC board application available, plus posted pins or sockets for point-to-point wiring.

CHAMP Connector — Section 7, Page 7-13. This connector represents an innovative development which has made possible the first insulation-displacing, mass-terminating connector that can terminate both solid and stranded wires as well as flat conductor cable.

